

IDD-636160S

160W DC/DC Converter Module

- Wide input range 6-36 VDC
- Selectable output voltage +12V, +19V or +24VDC
- Extended temperature range -20 ~ +70°C
- High efficiency up to 98%
- Compact design
- Including thermal pad for chassis mounting

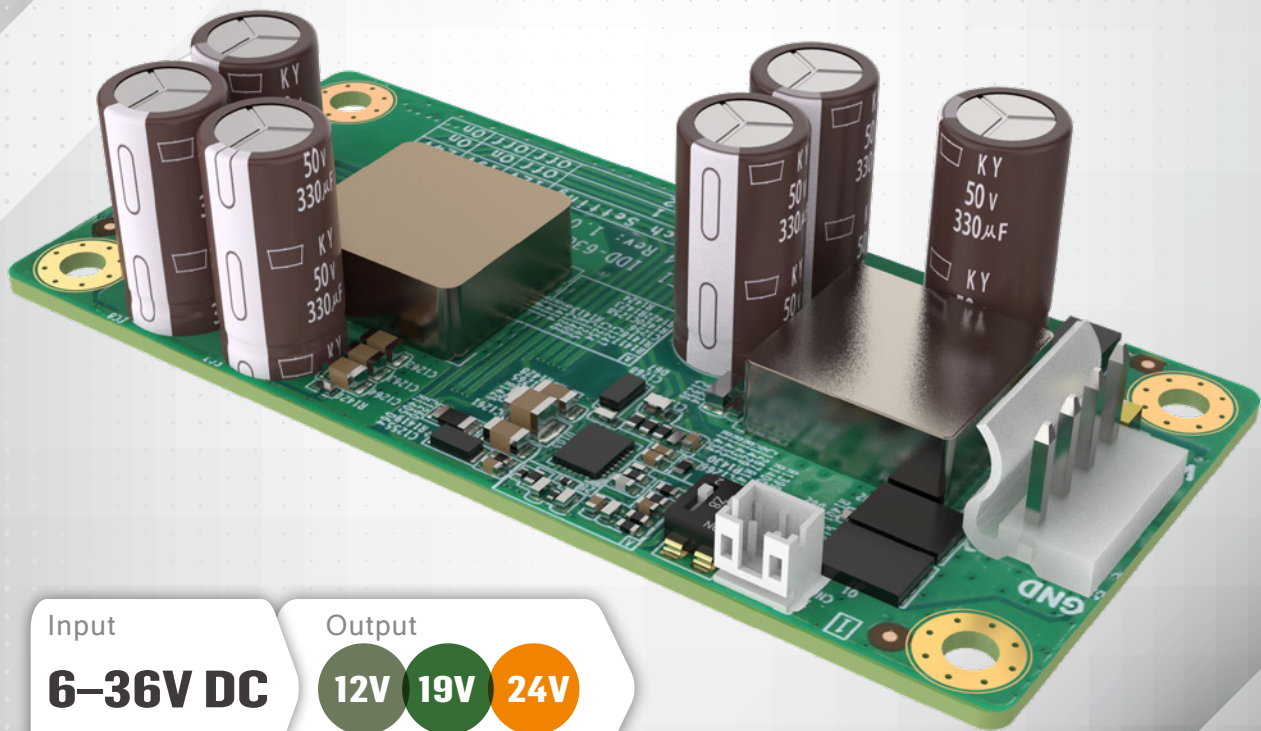

Input

6-36V DC

Output

12V 19V 24V

Selectable

IDD-636160S

160W DC/DC Converter Module

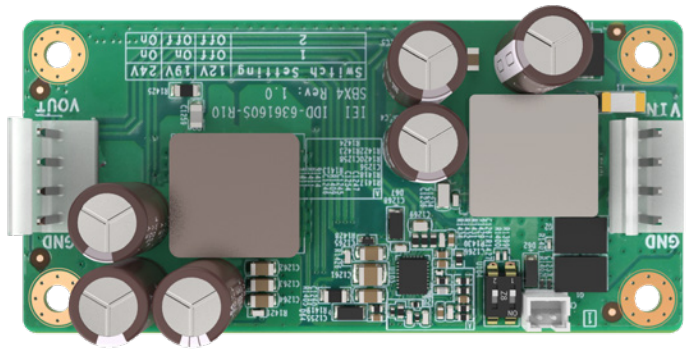

Industrial grade DC TO DC 160W power module, wide range 6-36V input and 3 selectable voltage outputs

IDD-636160S is a 160W power 98% efficient DC/DC power module. In addition to an ultra-wide input voltage range of 6-36V, it also provides three DIP switch selectable output voltages of 12/19/24V, which can be used for almost Powers any single voltage motherboard or embedded system with 160W power requirements.

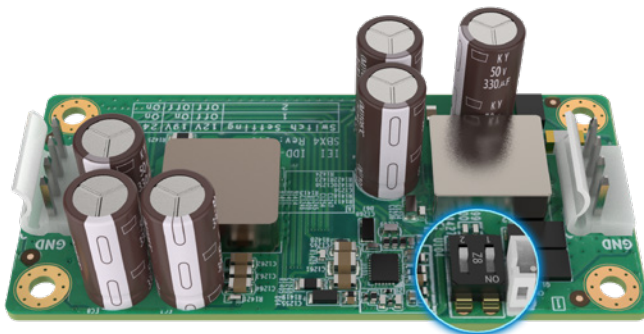

Output voltage		1	2
12V		Off	Off
19V		On	Off
24V		On	On

Optimize heat dissipation design

In order to improve the heat dissipation efficiency, high-power components are distributed on the bottom of the circuit board, and a heat-dissipating silicone pad with high thermal conductivity is used. The heat is introduced into the aluminum plate fixed at the bottom.

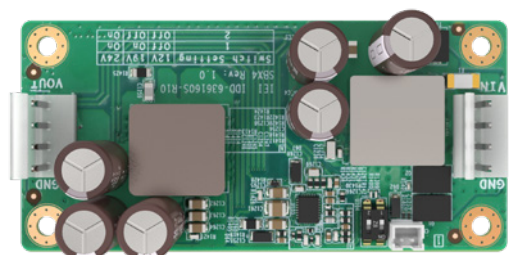
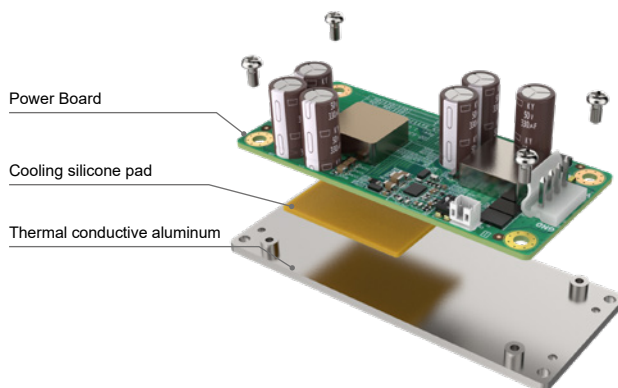

4pin socket with foolproof and buckle

It adopts A3960WV-04P type 4Pin fool-proof input and output terminals, providing a maximum current of 14A (maximum power consumption is only 80W when the minimum input is 6V). Users can customize input and output cables or purchase IEI optional products.

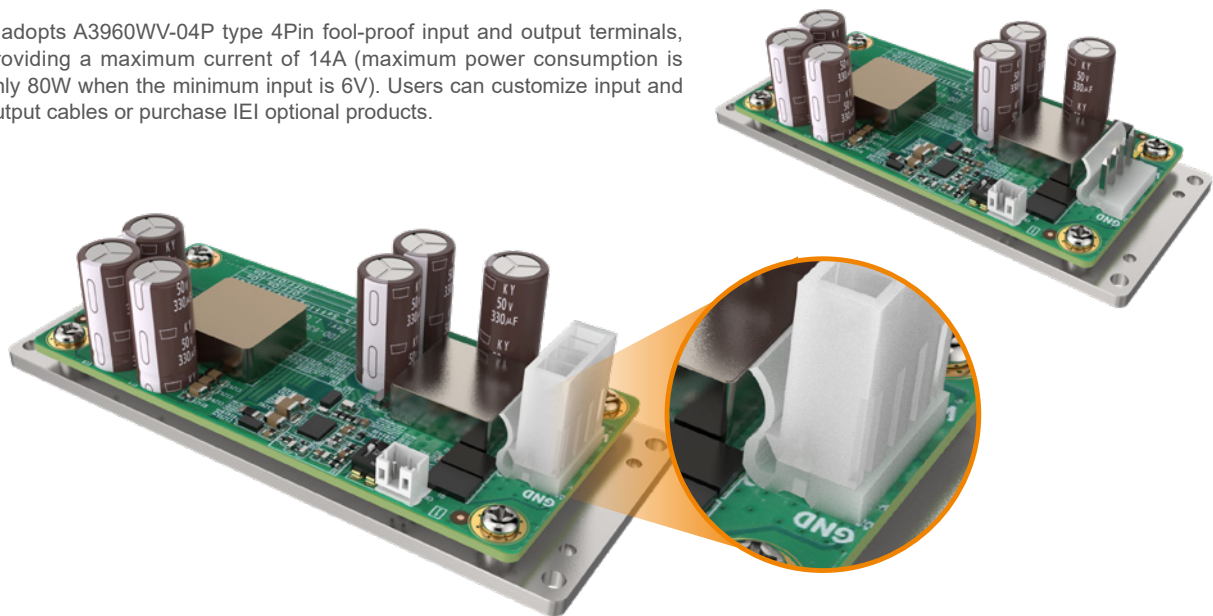

Bottom aluminum block that provides thermal conductivity

The product comes with a bottom aluminum block that provides thermal conductivity. Users can dissipate heat through the silicone pad. Fasten the IDD-636160S directly to the chassis. When tightly connected, it provides better heat conduction through the chassis. Or the user does not choose the bottom aluminum block that comes standard with IEI. Design better aluminum fin heat dissipation by yourself. Directly lock the IDD-636160S PCB board to the customer's facility.

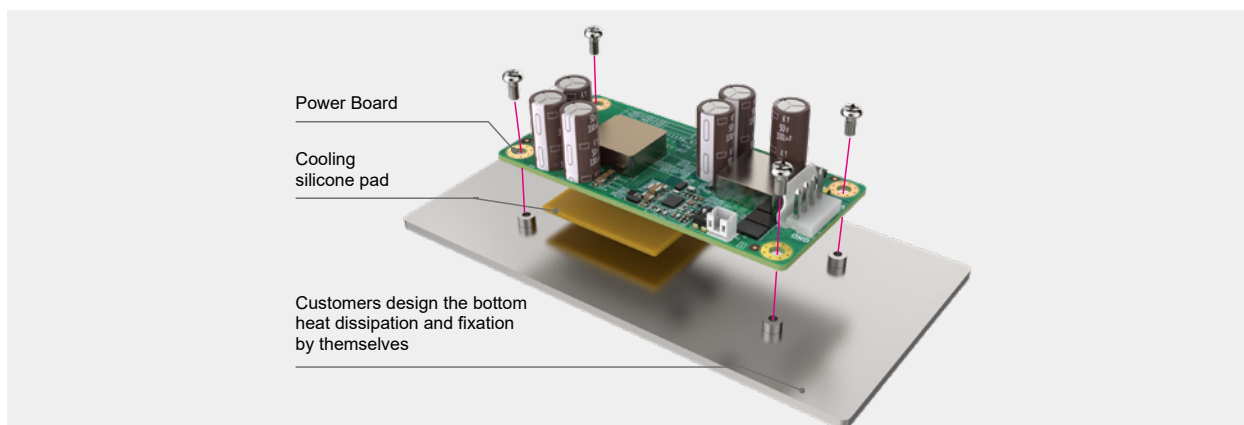
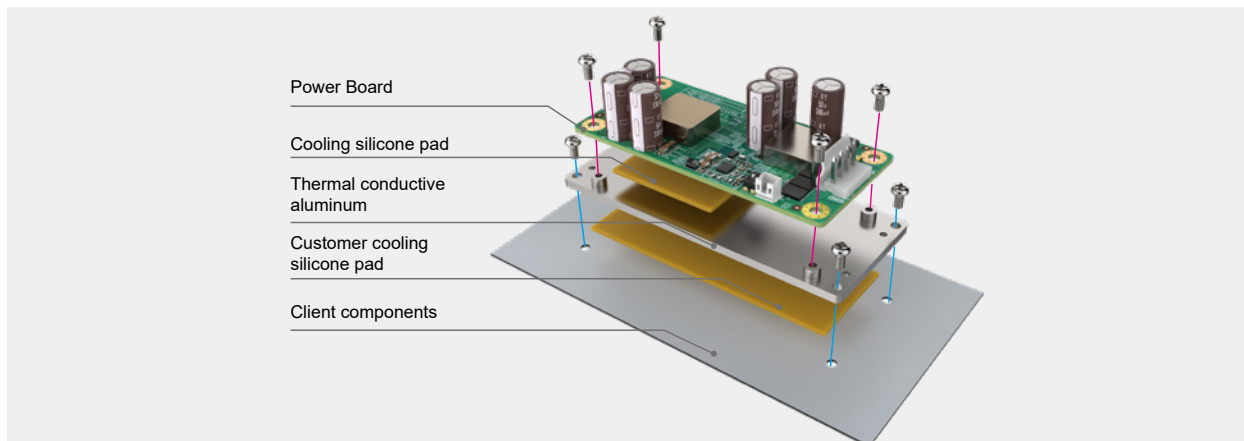

Power curve

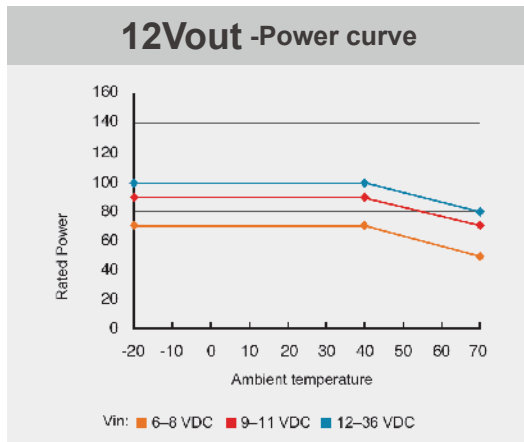

Efficiency curves

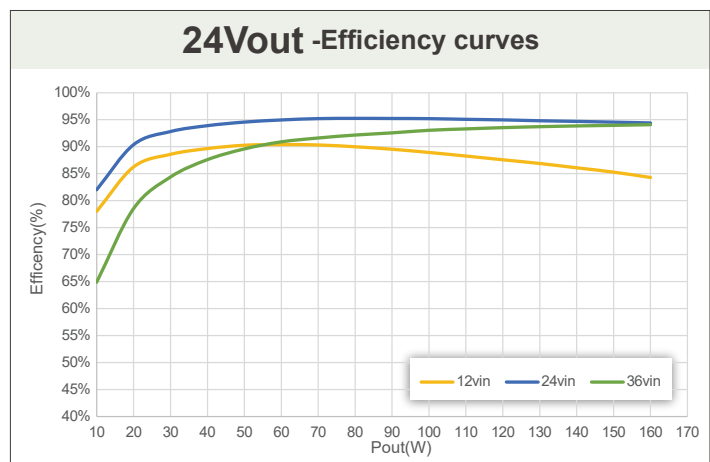
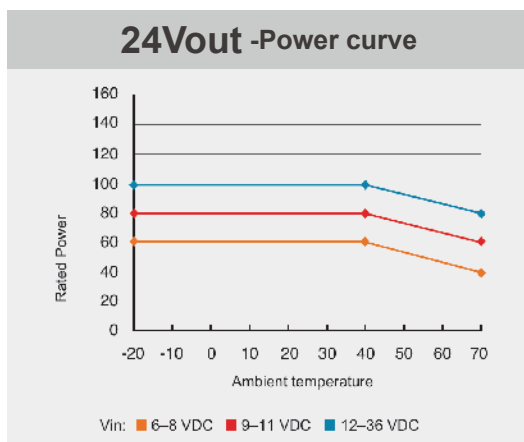
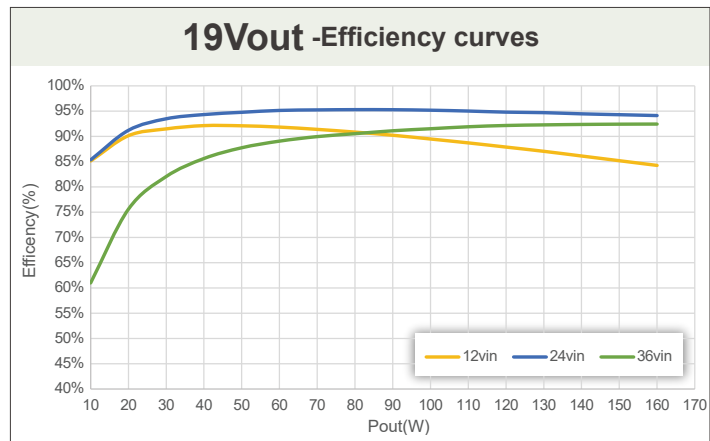
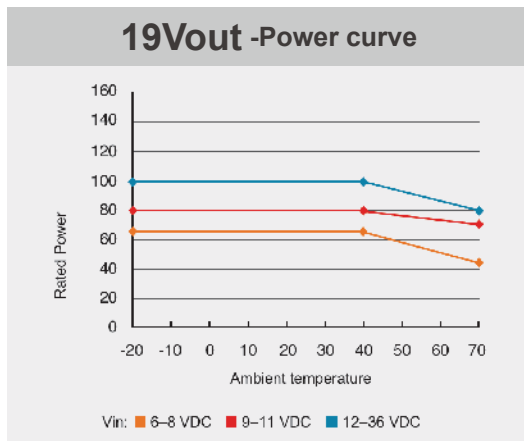
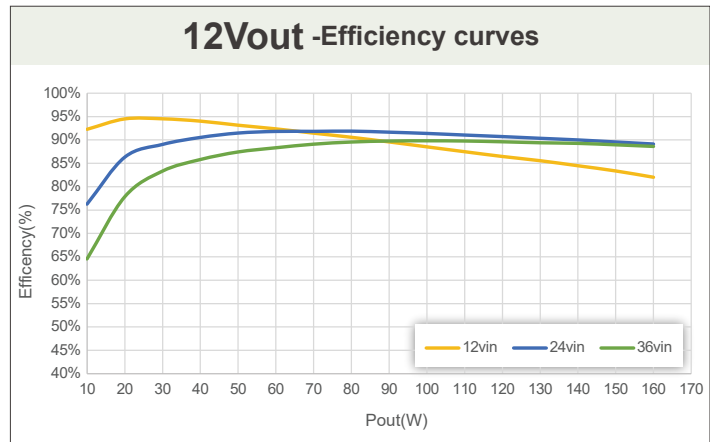

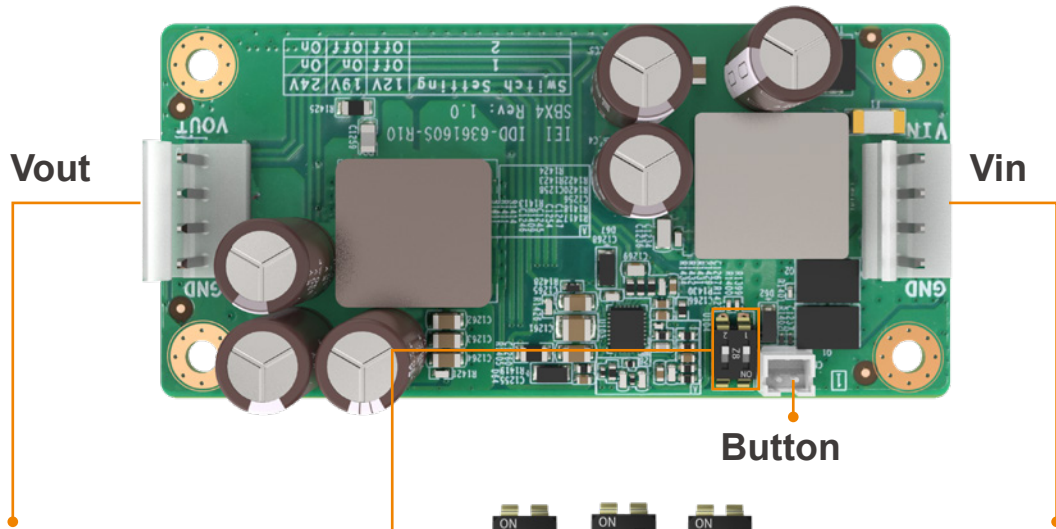

Pin No	Description
1	Vout
2	Vout
3	GND
4	GND

Switch

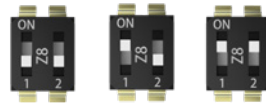

Switch Setting	12V	19V	24V
1	Off	On	On
2	Off	Off	On

Pin No	Description
1	DC_IN
2	DC_IN
3	GND
4	GND

Dimensions

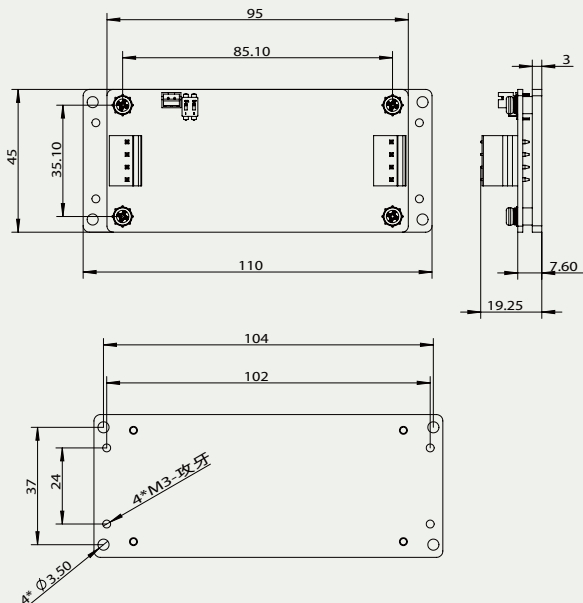

Specifications

Model	IDD-636160S
Input voltage	6-36V DC
Output voltage	12 or 19 or 24V DC via DIP switch
Installation method	Open frame
Max. total output	160W
Efficiency	Up to 98%
Dimensions	40 x 95 x 19.25 mm
Weight	100 g
Operation Temperature	-20°C~70°C
Storage Temperature	-40°C~85°C

Ordering Informaiton

IDD-636160S-R10	160W DC/DC 6~36V input, multiple 12/19/24V output power module
-----------------	--

Optional Accessories

32102-057300-100-RS	Power cable; 100mm/50mm (A) Molex 5239-0400 P=3.96 (B) DC Jack 5.5*2.5mm (C) Ring terminal-3.2mm (D) Terminal block 3P P=5.08
---------------------	---