

# DI-1200

12th Generation Intel Core i7/i5/i3 High Performance, Compact and Modular Rugged Embedded Computer

## HIGH PERFORMANCE • POWER-SAVING

DI-1200 | Intel Alder Lake-P Compact Rugged Computer



### Overview

[CONTACT](#)

The DI-1200, with a 12th generation Intel® Core™ U-series (Alder Lake-P Platform) processor, provides outstanding performance and boasts a low power consumption of 15W. The compact DI-1200 offers rich I/O interfaces and expansion options, meeting the requirements for high-performance, rugged embedded computers used in confined spaces. It suits for industrial automation, warehousing and logistics, transportation, environmental monitoring, and IoT applications.

### Key Features

- Onboard 12th Intel® Alder Lake-P U-Series Core™ i7/i5/i3 Processors
- 1 x DDR5 SO-DIMM Sockets, Supports up to 4800MHz 32GB Memory
- Quad Independent Display (2x DP/HDMI/CMI Display)
- 1x M.2 Key E Type 2230 Socket for Wireless/Intel CNVi Module Expansion
- 1x M.2 Key B Type 3042/3052 Socket for 5G/Storage/Add-on Card Expansion
- CMI Technology for Optional I/O Module Expansions
- CFM Technology for Power Ignition Sensing Function & PoE
- Wide Operating Temperature -40°C to 70°C

### Certifications



### High Performance & Power Saving

The DI-1200 supports the 12th generation Core™ i7/i5/i3 U-series (Alder Lake-P) processor based on the Intel® 7 process. Its exceptional processing performance and ultra-low power consumption of just 15W, make it highly suitable for mobile devices limited by battery capacity.

**15 Watts**

Low Power Consumption



### Smaller than A5

The DI-1200 has a footprint smaller than a sheet of A5 paper, with dimensions of only 203 x 142 x 66.8 mm. It is ideal for mobile devices such as AGVs and AMRs, tight spaces in vehicles, or small cabinets in factories.

### High-speed I/O

The DI-1200 offers a range of high-speed I/O, including LAN (10GbE, 2.5GbE, 1GbE), USB 3.2 (10Gbps, 5Gbps), USB 2.0, and more, making data and image transmission faster and allowing easy connection to various high-speed devices.





### Comprehensive Wireless Options

The DI-1200 has one M.2 Key E slot and one M.2 Key B slot, supporting a full range of wireless transmission options, including GSM, GNSS, Wi-Fi, and Bluetooth. It also supports the Intel CNVi module, meeting diverse transmission needs.

### Quick Hard Drive Removal

Mobile devices must allow quick access to data. The DI-1200 features a hot-swappable 2.5-inch SATA HDD/SSD slot in the front panel of the chassis, making it easy to remove the hard drive and access the data on it.



### Secure & Rugged

The DI-1200 showcases its ruggedness and industrial-grade protections through multiple industry certifications. It complies with industrial EMC standards (IEC 61000-6-2 and IEC 61000-6-4), ensuring reliable operation in external electromagnetic interference from surrounding devices. The DI-1200 also meets the U.S. military standard, MIL-STD-810H, ensuring stable operation under extreme shock and vibration conditions.

## Specifications

Model Name	DI-1200
<b>System</b>	
Processor	<ul style="list-style-type: none"> <li>Onboard 12th Intel® Alder Lake-P U-Series CPU:                             <ul style="list-style-type: none"> <li>Intel® Core™ i7-1265UE 10 Cores Up to 4.70 GHz, TDP 15W</li> <li>Intel® Core™ i5-1245UE 10 Cores Up to 4.40 GHz, TDP 15W</li> <li>Intel® Core™ i3-1215UE 6 Cores Up to 4.40 GHz, TDP 15W</li> </ul> </li> </ul>
Memory	<ul style="list-style-type: none"> <li>1x DDR5 SO-DIMM Socket, Supports Un-buffered and non-ECC Type, Up to 32GB</li> </ul>
BIOS	<ul style="list-style-type: none"> <li>AMI BIOS</li> </ul>
<b>Graphics</b>	
Graphics Engine	<ul style="list-style-type: none"> <li>Integrated Intel® Iris® Xe Graphics: Core™ i7-1265UE, i5-1245UE</li> <li>Integrated Intel® UHD Graphics: Core™ i3-1215UE</li> </ul>
Maximum Display Output	<ul style="list-style-type: none"> <li>Supports Quad Independent Display</li> </ul>
HDMI	<ul style="list-style-type: none"> <li>1x HDMI Connector (3840 x 2160@60Hz)</li> </ul>
DP	<ul style="list-style-type: none"> <li>2x DisplayPort Connector (3840 x 2160@60Hz)</li> </ul>
CMI Display	<ul style="list-style-type: none"> <li>1x CMI Interface for Optional CMI-DP/CMI-HDMI/CMI-VGA Module Expansion</li> </ul>
<b>Audio</b>	
Audio Codec	Realtek® ALC888, High Definition Audio
Line-out	<ul style="list-style-type: none"> <li>1x Line-out, Phone Jack 3.5mm</li> </ul>
Mic-in	<ul style="list-style-type: none"> <li>1x Mic-in, Phone Jack 3.5mm</li> </ul>
<b>I/O</b>	
LAN	<ul style="list-style-type: none"> <li>2x 2.5 GbE LAN, RJ45                             <ul style="list-style-type: none"> <li>GbE1: Intel® I225</li> <li>GbE2: Intel® I225</li> </ul> </li> </ul>
COM	<ul style="list-style-type: none"> <li>2x RS-232/422/485 with Auto Flow Control (Supports 5V/12V), DB9</li> </ul>
USB	<ul style="list-style-type: none"> <li>1x 10Gbps USB 3.2 Gen2 x1, Type A</li> <li>2x 5Gbps USB 3.2 Gen1 x1, Type A</li> <li>3x 480 Mbps USB 2.0, Type A</li> </ul>
<b>Storage</b>	
SSD/HDD	<ul style="list-style-type: none"> <li>1x 2.5" SATA HDD/SSD Bay (SATA 3.0)</li> </ul>
M.2 SSD	<ul style="list-style-type: none"> <li>1 x M.2 SSD shared by M.2 Key B Type 3052 Socket</li> </ul>
RAID	<ul style="list-style-type: none"> <li>Support RAID 0/1</li> </ul>
<b>Expansion</b>	
M.2 Key E Socket	<ul style="list-style-type: none"> <li>1x M.2 Key E Type 2230 Socket, Support Wireless / Intel CNVi Module Expansion</li> </ul>
M.2 Key B Socket	<ul style="list-style-type: none"> <li>1x M.2 Key B Type 3042/3052 Socket, Support 5G / Storage / Add-on Card Expansion</li> </ul>
SIM Socket	<ul style="list-style-type: none"> <li>2 x Front Accessible SIM Socket</li> </ul>
CMI (Combined Multiple I/O) Interface	<ul style="list-style-type: none"> <li>1x CMI Interface for optional CMI-LAN Module Expansion</li> <li>1x CMI Interface for optional CMI-Display / CMI-COM / CMI-DIO Module Expansion</li> </ul>
CFM (Control Function Module) Interface	<ul style="list-style-type: none"> <li>1x CFM IGN Interface for optional CFM-IGN Module Expansion</li> </ul>
<b>Other Function</b>	
External FAN Connector	<ul style="list-style-type: none"> <li>1x External FAN Connector, 4-pin Terminal Block (Support Smart Fan by BIOS)</li> </ul>

Clear CMOS Switch	• 1x Clear CMOS Switch
Reset Button	• 1x Reset Button
Instant Reboot	• Support 0.2sec Instant Reboot Technology
Watchdog Timer	• Software Programmable Supports 256 Levels System Reset
<b>Power</b>	
Power Button	• 1x ATX Power On/Off Button
Power Mode Switch	• 1x AT/ATX Mode Switch
Power Input	• 9 - 48VDC, 3-pin Terminal Block
Remote Power On/Off	• 1x Remote Power On/Off, 2-pin Terminal Block
Remote Power LED	• 1x Remote Power LED, 2-pin Terminal Block
<b>Physical</b>	
Dimension ( W x D x H )	• 203 x 142 x 66.8 mm
Weight Information	• 1.8 KG
Mechanical Construction	• Extruded Aluminum with Heavy Duty Metal
Mounting	• Wall / Side / DIN-RAIL / VESA Mount
Physical Design	<ul style="list-style-type: none"> <li>• Fanless Design</li> <li>• Cableless Design</li> <li>• Jumper-less Design</li> <li>• Unibody Design</li> </ul>
<b>Reliability &amp; Protection</b>	
Reverse Power Input	• Yes
Over Voltage Protection	<ul style="list-style-type: none"> <li>• Protection Range: 51~58V</li> <li>• Protection Type: shut down operating voltage, re-power on at the preset level to recover</li> </ul>
Over Current Protection	• 15A
CMOS Battery Backup	• SuperCap Integrated for CMOS Battery Maintenance-free Operation
MTBF	• 486,235 Hours - Database: Telcordia SR-332 Issue3, Method 1, Case 3
<b>Operating System</b>	
Windows	• Windows® 10
Linux	• Supports by project
<b>Environment</b>	
Operating Temperature	<ul style="list-style-type: none"> <li>• -40°C to 70°C</li> <li>- PassMark Burn-In Test: 100% CPU, 2D/3D Graphics (without thermal throttling)</li> <li>- With extended temperature peripherals; Ambient with air flow</li> <li>- According to IEC60068-2-1, IEC60068-2-2, IEC60068-2-14</li> </ul>
Storage Temperature	• -40°C to 70°C
Relative Humidity	• 95%RH @ 70°C (non-Condensing)
Shock	• MIL-STD-810H
Vibration	• MIL-STD-810H
EMC	<ul style="list-style-type: none"> <li>• CE, UKCA, FCC, ICES-003 Class A</li> <li>• EN IEC 61000-6-4 / EN IEC 61000-6-2 (24VDC Input Only)</li> <li>• EN 50155 (EN 50121-3-2 Only)</li> <li>• E-mark (Pending)</li> </ul>

EMI	<ul style="list-style-type: none"> <li>• CISPR 32 Conducted &amp; Radiated: Class A</li> <li>• EN/BS EN 50121-3-2 Conducted &amp; Radiated: Class A</li> <li>• EN/BS EN IEC 61000-3-2 Harmonic current emissions: Class A</li> <li>• EN/BS EN 61000-3-3 Voltage fluctuations &amp; flicker</li> <li>• FCC 47 CFR Part 15B, ICES-003 Conducted &amp; Radiated: Class A</li> </ul>
EMS	<ul style="list-style-type: none"> <li>• EN/IEC 61000-4-2 ESD: Contact: 6 kV; Air: 8 kV</li> <li>• EN/IEC 61000-4-3 RS: 80 MHz to 1000 MHz: 20 V/m</li> <li>• EN/IEC 61000-4-4 EFT: AC Power: 2 kV; DC Power: 2 kV; Signal: 2 kV</li> <li>• EN/IEC 61000-4-5 Surges: AC Power: 2 kV; Signal: 1 kV</li> <li>• EN/IEC 61000-4-6 CS: 10V</li> <li>• (**Compliant with the standard when utilizing shielded cable.)</li> <li>• EN/IEC 61000-4-8 PFMF: 50 Hz, 30A/m</li> <li>• EN/IEC 61000-4-11 Voltage Dips &amp; Voltage Interruptions: 1 cycles at 60 Hz</li> </ul>

**External Layout**

**Front I/O**

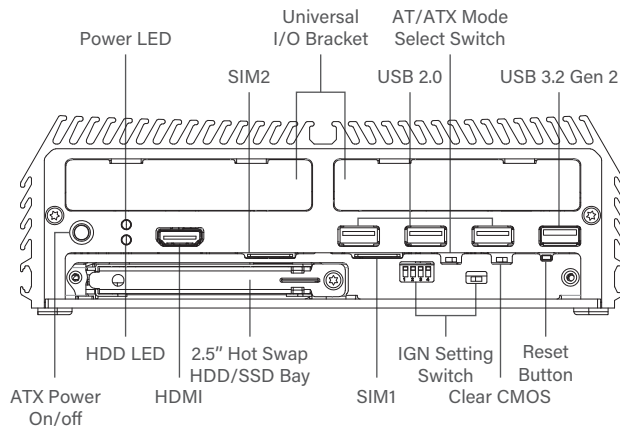

**Rear I/O**

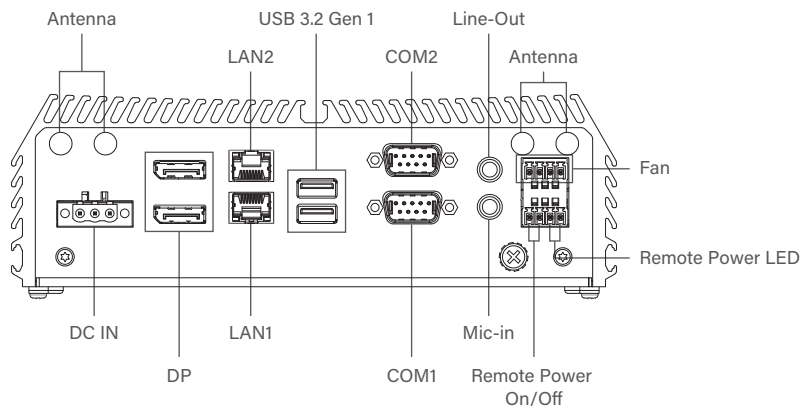

**Dimensions**

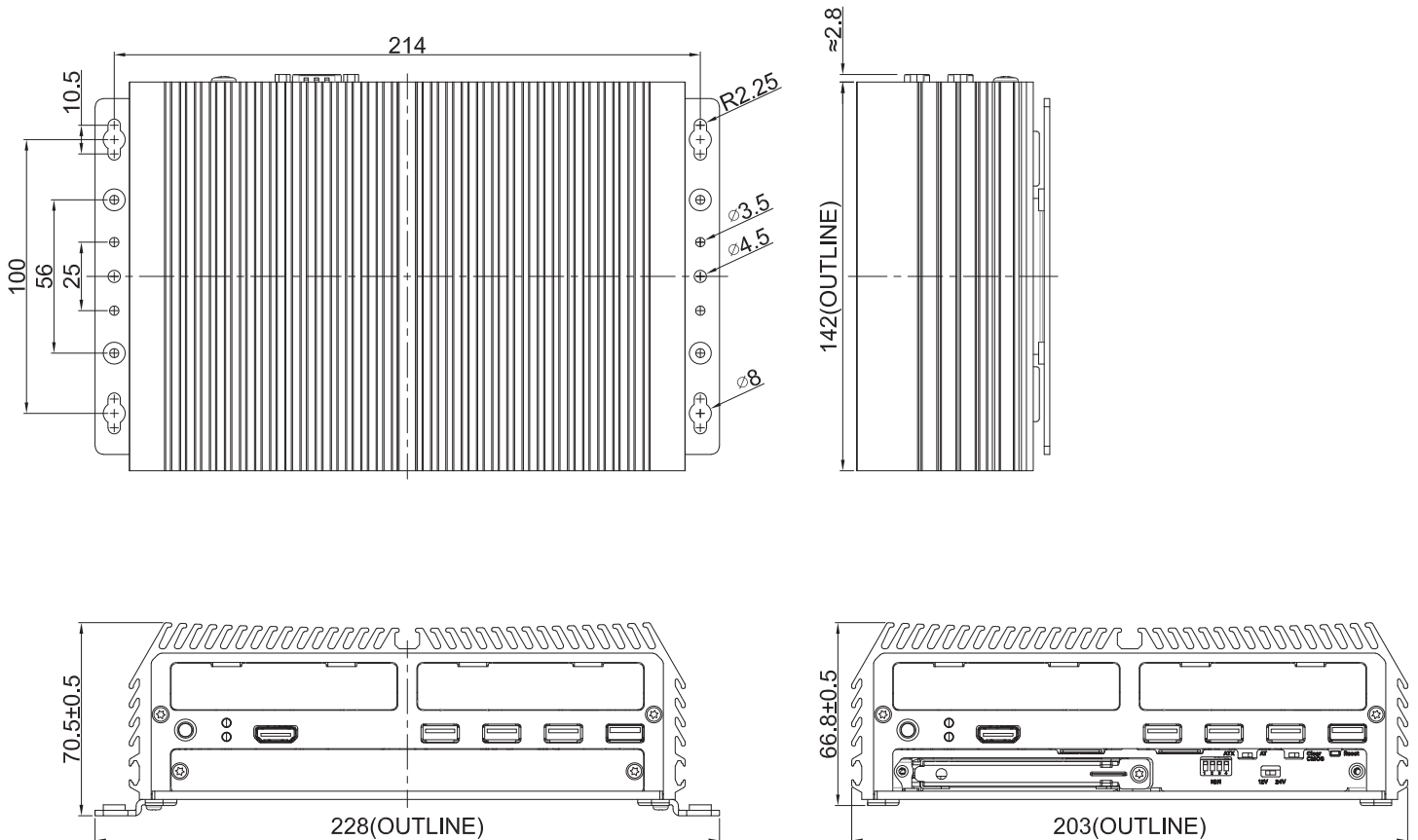

## Ordering Information

### Available Models

Model No.	Description
DI-1200-i7-R10	12th Generation Intel Core i7-1265UE High Performance, Compact and Modular Rugged Embedded Computer
DI-1200-i5-R10	12th Generation Intel Core i5-1245UE High Performance, Compact and Modular Rugged Embedded Computer
DI-1200-i3-R10	12th Generation Intel Core i3-1215UE High Performance, Compact and Modular Rugged Embedded Computer

### Package Checklist

• DI-1200 Embedded Computer x1	• Power Terminal Block Connector x 1
• CPU Thermal Pad x1	• Remote Power On/Off + Remote Power LED Connector x 1
• Screw Pack x 1	• Fan Terminal Block Connector x 1
• Wall Mounting Kit x 1	• M.2 Key B Type 3052 to 3042 Adapter Bracket x 1

### Optional Modules and Accessories







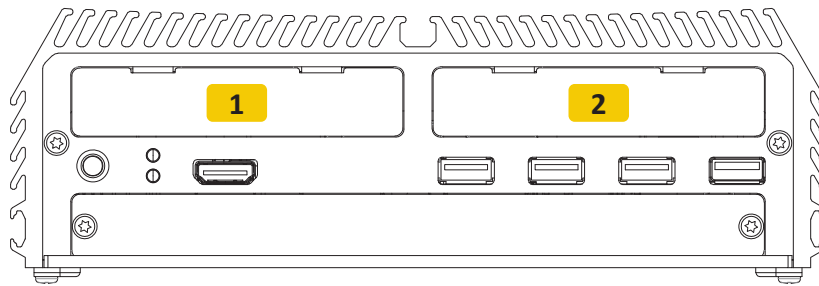

Model No.	Description
CFM-IGN102	CFM Module with Power Ignition Sensing Control Function, 12V/24V Selectable
CFM-PoE06-R10	CFM Module with PoE Function, Individual Port 25.5W
CMI-LAN01-R12	CMI Module with 4x RJ45 Intel I210 GbE LAN Ports
CMI-M12LAN01-R12	CMI Module with 4 x M12 Intel I210 GbE LAN Ports
CMI-XM12LAN01-R10	CMI Module with M12 X-Coded Connector, 4x Intel I210 GbE LAN Ports
CMI-10GLAN04-R10	CMI Module with 2x Intel X550 10GbE LAN Ports
CMI-VGA02-R10	CMI Module with 1x VGA Port
CMI-HD04-R10	CMI Module with 1x HDMI Port
CMI-DP02-R10	CMI Module with 1x DisplayPort
CMI-DIO05-R10	CMI Module with 16DIO (8in 8out)
CMI-COM05-R10	CMI Module with 2x RS232/422/485 (Support 5V/12V)
UB1503-R11	Universal Bracket with 2x DB9 Cutout
UB1506-R10	Universal Bracket with DisplayPort Cutout
UB1508-R10	Universal Bracket with HDMI Cutout
UB1510-R11	Universal Bracket with 4x M12 Cutout
UB1512-R11	Universal Bracket with 4x RJ45 Cutout for CMI-LAN Expansion
UB1516-R10	Universal Bracket with VGA Cutout
UB1518-R10	Universal Bracket with DIO Cutout
UB1528-R11	Universal Bracket with 2x RJ45 Cutout for CMI-10GLAN Expansion
DINRAIL-R10	Diamond series DIN-RAIL Mount Kit

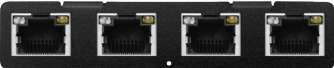

Model No.	Description
FAN-EX103	External Fan with 4pin Terminal Block Plug and Mounting Bracket, Support Smart Fan (*External fan must be installed when using CFM-PoE module)
SIDE01	DI Series Side Mount Kit
GST60A12-CIN1	Adapter AC/DC 12V 5A 60W with 3pin Terminal Block Plug and Tubes, Level VI
GST120A24-CIN	Adapter AC/DC 24V 5A 120W with 3pin Terminal Block Plug and Tubes, Level VI
GST220A24-CIN	Adapter AC/DC 24V 9.2A 220W with 3pin Terminal Block Plug and Tubes, Level VI

**Optional Module Configuration**



Model No.	Description	1	2
CMI-LAN01-R12/UB1512-R11 	CMI Module with 4x Intel I210 GbE LAN, RJ45 Port / Universal Bracket with 4x RJ45 Cutout for CMI-LAN Expansion	--	V
CMI-M12LAN01-R12/UB1510-R11 	CMI Module with M12 Connector, 4x Intel I210 GbE LAN Ports / Universal Bracket with 4x M12 Cutout	--	V
CMI-XM12LAN01-R10/UB1510-R11 	CMI Module with M12 X-Coded Connector, 4x Intel I210 GbE LAN Ports / Universal Bracket with 4x M12 Cutout	--	V
CMI-10GLAN04-R10/UB1528-R11 	CMI Module with 2x Intel X550 10GbE LAN, RJ45 Port / 1x Universal Bracket with 2x RJ45 Cutout for CMI-10GLAN Expansion	--	V
CMI-VGA02/UB1516-R10 	CMI Module with 1x VGA Port/Universal Bracket with VGA Cutout	V	--
CMI-HD04/UB1508-R10 	CMI Module with 1x HDMI Port/Universal Bracket with HDMI Cutout	V	--
CMI-DP02/UB1506-R10 	CMI Module with 1x DisplayPort/Universal Bracket with DisplayPort Cutout	V	--
CMI-COM05-R10/UB1503-R11 	CMI Module with 2x RS232/422/485 Ports (Support 5V/12V) / 1x Universal Bracket with 2x DB9 Cutout	V	--
CMI-DIO05-R10 / UB1518-R10 	CMI Module with 16DIO (8in 8out) / 1x Universal Bracket with DIO Cutout	V	--

V : Compatible



**Distributore per l'Italia: Contradata Milano S.r.l.**  
Via Solferino 12 - 20900 Monza (MB) - Italy  
Tel: (+39) 039-230.14.92 Email: info@contradata.it

[www.contradata.it](http://www.contradata.it)

Updated: Jan. 15, 2024