

# CO-119C/P2102 Series

19" TFT-LCD Open Frame Panel PC with 8th Gen.Intel® Core™ U Series Processor



## ALL-NEW OPEN FRAME PANEL PC

| CO-100/P2000 Series Fits Any Machine Perfectly |

### Overview

 GET QUOTE

Cincoze's high-performance open-frame modular panel PCs (CO-119C/P2102 Series) use Intel® Core U series processors that provide high-performance data processing and graphics computing capabilities with only 15W low power consumption. The CO-100/P2102 series supports CFM technology that extends system functions according to requirements, with options such as Power Ignition Sensing (IGN) and Power over Ethernet (PoE). The series has multiple sizes, display ratios (4:3 and 16:9), and touchscreen options. Its integrated structure, exclusive adjustable mounting bracket, and support for multiple mounting methods to perfectly fit cabinets of different materials and thicknesses. The robust design also meets the application needs of harsh industrial environments.

- 19" TFT-LCD with Projected Capacitive Touch
- Onboard 8th Generation Intel® Core™ U Series Processor
- 2x DDR4 SO-DIMM Socket, Supports Up to 2400MHz, 64GB
- Designed with Adjustable Mounting Bracket
- Support Flat / Standard / VESA / Rack Mount
- Front Panel IP65 Compliant
- Wide Operating Temperature
- Cincoze Patent CDS Technology Support

## High Performance and Power Saving

Intel® Core U series processors provide high-performance data processing and graphics computing capabilities with a 15W low power consumption, support for up to 64GB of memory and two 2.5" HDD/SSD.



**15W TDP  
CPU Design**

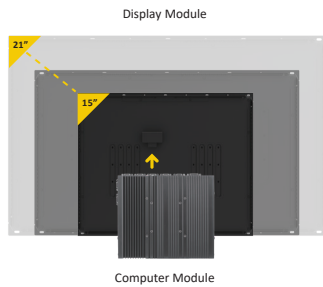

## Patented CDS Technology

The patented CDS (Convertible Display System) technology makes maintenance easy and offers flexibility for future upgrades. To upgrade the panel size, replace the display module, or to upgrade the system performance, replace the computer module.

Patent No. M482908

## Flexibility for Various Applications

Mini-PCIe and PCI/PCIe expansion slots support data acquisition cards, motion control cards, I/O expansion, and other applications.

[ PCI/PCIe expansion slot available Model : CO-119C/P2102E ]

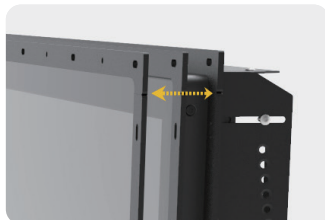

## Flexible Design and Easy Installation

Exclusive adjustable mounting bracket with thickness adjustment setting and two panel-locking methods (panel or boss type) make modular panel PC easier and more convenient to integrate into industrial machinery.

Patent No.: D224544, D224545, I802427

## Integrated Structure

As standard, the open frame modular panel pc can be deployed in equipment machines, but remove the mounting bracket and it becomes a standalone panel pc for use with a VESA mount or in a 19" rack.



## Strong, Reliable and Durable

Meets the requirements for HMI applications in harsh industrial environments: IP65 waterproof and dustproof front panel, fanless, wide temperature (0-60°C), and wide voltage (9-48 VDC).

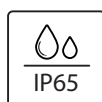
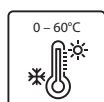

**CO-119C Specifications**

Model Name	CO-119C
<b>Display</b>	
LCD Size	• 19" (5:4)
Resolution	• 1280 x 1024
Brightness	• 350 cd/m2
Contract Ratio	• 1000 : 1
LCD Color	• 16.7M
Pixel Pitch	• 0.294 (H) x 0.294 (V)
Viewing Angle	• 170 (H) / 160 (V)
Backlight MTBF	• 50,000 hrs (LED Backlight)
<b>Touch Screen</b>	
Touchscreen Type	• Projected Capacitive Touch
<b>Physical</b>	
Dimension (W x D x H)	• 472.8 x 397.5 x 63mm
Weight	• 6.91kg
Construction	• One-piece and Slim Bezel Design
Mounting Type	• Flat / Standard / VESA / Rack Mount
Mounting Bracket	• Pre-installed Mounting Bracket with Adjustable Design ( Support 11 different stages of adjustment )
<b>Protection</b>	
Ingress Protection	• Front Panel IP65 Compliant * According to IEC60529
<b>Environment</b>	
Operating Temperature	• 0°C - 50°C (with Industrial Grade peripherals; Ambient with air flow)
Storage Temperature	• -20°C to 60°C
Humidity	• 80% RH @ 50°C (Non-condensing)
EMC	• CE, UKCA, FCC, ICES-003 Class A
EMI	<ul style="list-style-type: none"> <li>• CISPR 32 Conducted &amp; Radiated: Class A</li> <li>• EN/BS EN 55032 Conducted &amp; Radiated: Class A</li> <li>• EN/BS EN IEC 61000-3-2 Harmonic current emissions: Class A</li> <li>• EN/BS EN61000-3-3 Voltage fluctuations &amp; flicker</li> <li>• FCC 47 CFR Part 15B, ICES-003 Conducted &amp; Radiated: Class A</li> </ul>
EMS	<ul style="list-style-type: none"> <li>• EN/IEC 61000-4-2 ESD: Contact: 4 kV; Air: 8 kV</li> <li>• EN/IEC 61000-4-3 RS: 80 MHz to 1000 MHz: 3 V/m</li> <li>• EN/IEC 61000-4-4 EFT: AC Power: 1 kV; DC Power: 0.5 kV; Signal: 0.5 kV</li> <li>• EN/IEC 61000-4-5 Surges: AC Power: 2 kV; Signal: 1 kV</li> <li>• EN/IEC 61000-4-6 CS: 3V</li> <li>• EN/IEC 61000-4-8 PFMF: 50 Hz, 1A/m</li> <li>• EN/IEC 61000-4-11 Voltage Dips &amp; Voltage Interruptions: 0.5 cycles at 50 Hz</li> </ul>

## P2102 Series Specifications

Model Name	P2102	P2102E
<b>System</b>		
Processor	<ul style="list-style-type: none"> <li>Onboard 8th Intel® Core™ U Processors (Whiskey Lake)                             <ul style="list-style-type: none"> <li>Intel® Core™ i5-8365UE Quad Core Processor (6M Cache, up to 4.10 GHz)</li> <li>Intel® Core™ i3-8145UE Dual Core Processor (4M Cache, up to 3.90 GHz)</li> <li>TDP: 15 W</li> </ul> </li> </ul>	
Memory	<ul style="list-style-type: none"> <li>2x DDR4 2400 MHz 260-Pin SO-DIMM Socket</li> <li>Support Un-buffered and Non-ECC Type up to 64 GB</li> </ul>	
<b>Graphics</b>		
Graphics Engine	<ul style="list-style-type: none"> <li>Integrated Intel® UHD Graphics 620</li> </ul>	
Maximum Display Output	<ul style="list-style-type: none"> <li>Supports Triple Independent Display</li> </ul>	
CDS	<ul style="list-style-type: none"> <li>1x CDS Connector for Cincoze Display Module</li> </ul>	
VGA	<ul style="list-style-type: none"> <li>1x VGA Connector(1920 x 1200 @60Hz)</li> </ul>	
DP	<ul style="list-style-type: none"> <li>1x DisplayPort Connector (4096 x 2304 @ 60Hz, According to CPU Specifications)</li> <li>* Verified maximum resolution: 3840 x2160 @ 60Hz</li> </ul>	
<b>Audio</b>		
Audio Codec	<ul style="list-style-type: none"> <li>Realtek® ALC888, High Definition Audio</li> </ul>	
Line-out	<ul style="list-style-type: none"> <li>1x Line-out, Phone Jack 3.5mm</li> </ul>	
Mic-in	<ul style="list-style-type: none"> <li>1x Mic-in, Phone Jack 3.5mm</li> </ul>	
<b>I/O</b>		
LAN	<ul style="list-style-type: none"> <li>2x GbE LAN (Supports WoL, Teaming, Jumbo Frame &amp; PXE), RJ45                             <ul style="list-style-type: none"> <li>GbE1: Intel® I219LM</li> <li>GbE2: Intel® I210</li> </ul> </li> </ul>	
USB	<ul style="list-style-type: none"> <li>3x USB 3.2 Gen2 (Type A), 2x USB 2.0 (Type A)</li> </ul>	
Serial Port	<ul style="list-style-type: none"> <li>4x RS-232/422/485 with Auto Flow Control Support 5V/12V, DB9</li> </ul>	
DIO	<ul style="list-style-type: none"> <li>16x Isolated Digital I/O (8in/8out), 20-Pin Terminal Block</li> </ul>	
<b>Storage</b>		
SSD/HDD	<ul style="list-style-type: none"> <li>2x 2.5" HDD/SSD Drive Bay (SATA 3.0), Supports RAID 0/1</li> </ul>	
<b>Expansion</b>		
Mini PCI Express	<ul style="list-style-type: none"> <li>2x Full-size Mini-PCIe Sockets</li> </ul>	
PCI Express		<ul style="list-style-type: none"> <li>1x PCI or 1x PCIe x4 Expansion slot with Optional Riser Card</li> <li>* Supports maximum dimensions of add-on card (H x L) : 111 x 169mm</li> </ul>
M.2 E Key Socket	<ul style="list-style-type: none"> <li>1x M.2 2230 E Key Socket for Wireless Module, Supports Intel CRF Module</li> </ul>	
SIM Socket	<ul style="list-style-type: none"> <li>1x Front Accessible SIM Socket</li> </ul>	
Universal Bracket		<ul style="list-style-type: none"> <li>2x Universal I/O Bracket</li> </ul>
CFM (Control Function Module) Interface	<ul style="list-style-type: none"> <li>2x CFM Interface for optional IGN or PoE Module Expansion</li> </ul>	
CDS (Convertible Display System) Technology	<ul style="list-style-type: none"> <li>1x Convertible Display System (CDS) Interface</li> </ul>	

<b>Other Function</b>		
Clear CMOS Switch	• 1 x Clear CMOS Switch	
Instant Reboot	• Support 0.2sec Instant Reboot technology	
Watchdog Timer	• Software Programmable Supports 256 Levels System Reset	
Internal Speaker	• AMP 2W + 2W	
OSD Function	• LCD On/Off, Brightness Up, Brightness Down	
Reset Button	• 1x Reset Button	
<b>Power</b>		
Power Button	• 1x ATX Power On/Off Switch	
Power Mode Switch	• 1x AT/ATX Mode Switch	
Power Input	• 1x 3-pin Terminal Block Connector with Power Input 9~48VDC	
Power Adapter (Optional)	• 1x Optional AC/DC 12V/5A, 60W or 24V/5A 120W	
Remote Power On/Off	• 1x Remote Power On/Off Connector, 2-pin Terminal Block	
<b>Physical</b>		
Dimension( W x D x H )	• 254.5 x 190 x 41.5mm	• 254.5 x 190 x 61 mm
Weight Information	• 2.2 kg	• 2.7 kg
Mechanical Construction	• Extruded Aluminum with Heavy Duty Metal	
Mounting	• Wall / VESA / CDS / DIN Rail	
Physical Design	• Fanless Design • Jumper-less Design	
<b>Reliability &amp; Protection</b>		
Reverse Power Input	• Yes	
Over Voltage Protection	• Protection Range: 51~58V • Protection Type: shut down operating voltage, re-power on at the present level to recover	
Over Current Protection	• 15A	
ESD Protection	• +/-8kV (air), +/-4kV (contact)	
CMOS Battery Backup	• SuperCap Integrated for CMOS Battery Maintenance-free Operation	
MTBF	• 231,243 hours	
<b>Operating System</b>		
Microsoft® Windows®	• Windows®10	
Linux	• Supports by project	
<b>Environment</b>		
Operating Temperature	• Ambient with Air Flow: -40°C to 70°C (with Extended Temperature Peripherals)	
Storage Temperature	• -40°C to 70°C	
Relative humidity	• 95% RH @ 70°C (Non-condensing)	
Shock	• Operating, 50 Grms, Half-sine 11ms Duration (w/ SSD, according to IEC60068-2-27)	
Vibration	• Operating, 5 Grms, 5-500 Hz, 3 Axes (w/ SSD, according to IEC60068-2-64)	• Operating, 5 Grms, 5-500 Hz, 3 Axes (w/ SSD, according to IEC60068-2-64) • Operating, 1 Grms, 10-500 Hz, 3 Axes (w/ CV-W124 only, according to IEC60068-2-6)
EMC	• CE, UKCA, FCC, ICES-003 Class A	

EMI	<ul style="list-style-type: none"> <li>• CISPR 32 Conducted &amp; Radiated: Class A</li> <li>• EN/BS EN 55032 Conducted &amp; Radiated: Class A</li> <li>• EN/BS EN IEC 61000-3-2 Harmonic current emissions: Class A</li> <li>• EN/BS EN61000-3-3 Voltage fluctuations &amp; flicker</li> <li>• FCC 47 CFR Part 15B, ICES-003 Conducted &amp; Radiated: Class A</li> </ul>
EMS	<ul style="list-style-type: none"> <li>• EN/IEC 61000-4-2 ESD: Contact: 4 kV; Air: 8 kV</li> <li>• EN/IEC 61000-4-3 RS: 80 MHz to 1000 MHz: 3 V/m</li> <li>• EN/IEC 61000-4-4 EFT: AC Power: 1 kV; DC Power: 0.5 kV; Signal: 0.5 kV</li> <li>• EN/IEC 61000-4-5 Surges: AC Power: 2 kV; Signal: 1 kV</li> <li>• EN/IEC 61000-4-6 CS: 3V</li> <li>• EN/IEC 61000-4-8 PFMF: 50 Hz, 1A/m</li> <li>• EN/IEC 61000-4-11 Voltage Dips &amp; Voltage Interruptions: 0.5 cycles at 50 Hz</li> </ul>
Safety	<ul style="list-style-type: none"> <li>• UL, cUL, CB, IEC, EN62368-1</li> </ul>
Fire Protection	<ul style="list-style-type: none"> <li>• EN 45545-2</li> </ul>

**CO-119C/P2102 External Layout**

Front I/O

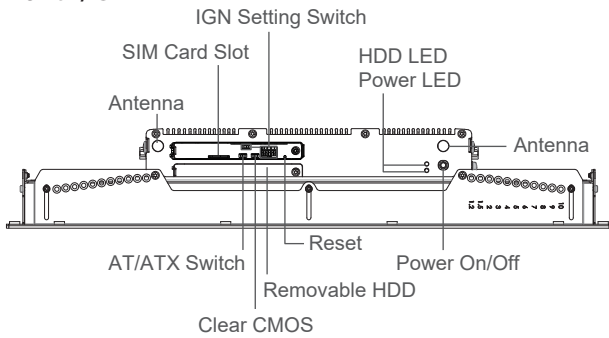

Rear I/O

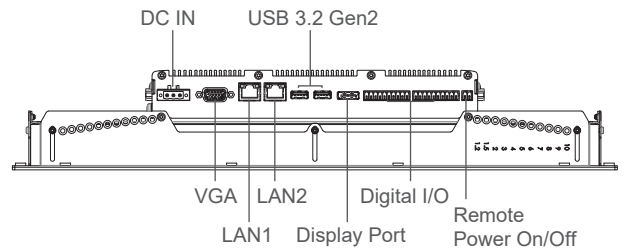

Left I/O

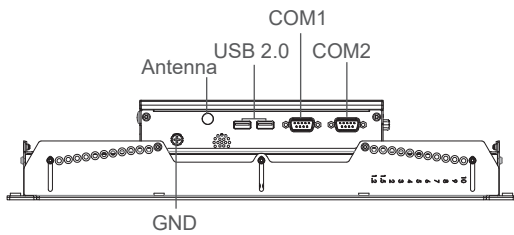

Right I/O

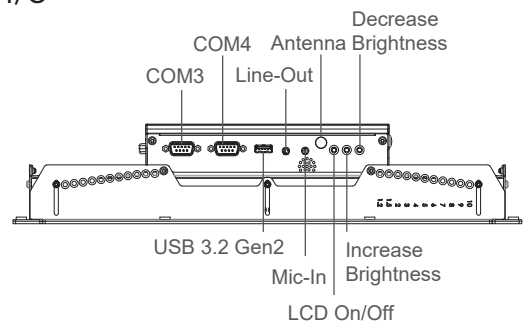

**CO-119C/P2102E External Layout**

Front I/O

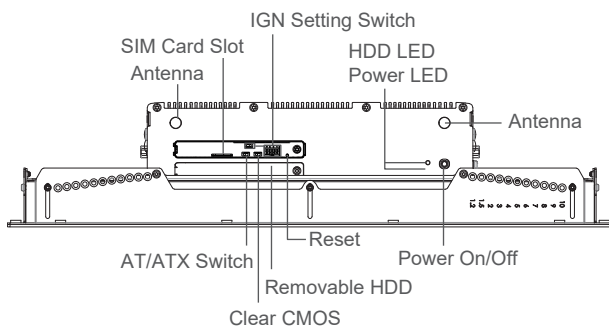

Rear I/O

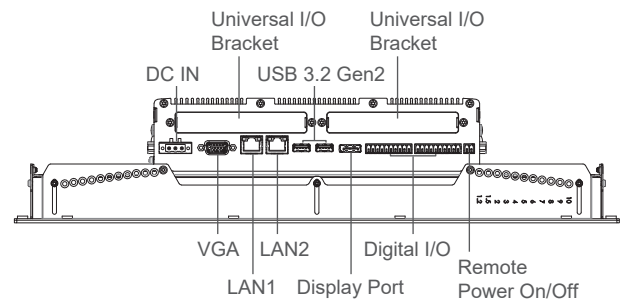

Left I/O

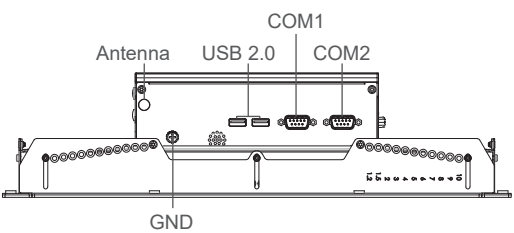

Right I/O

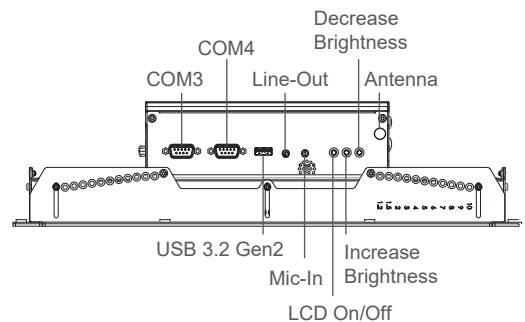

**CO-119C/P2102 Dimensions**

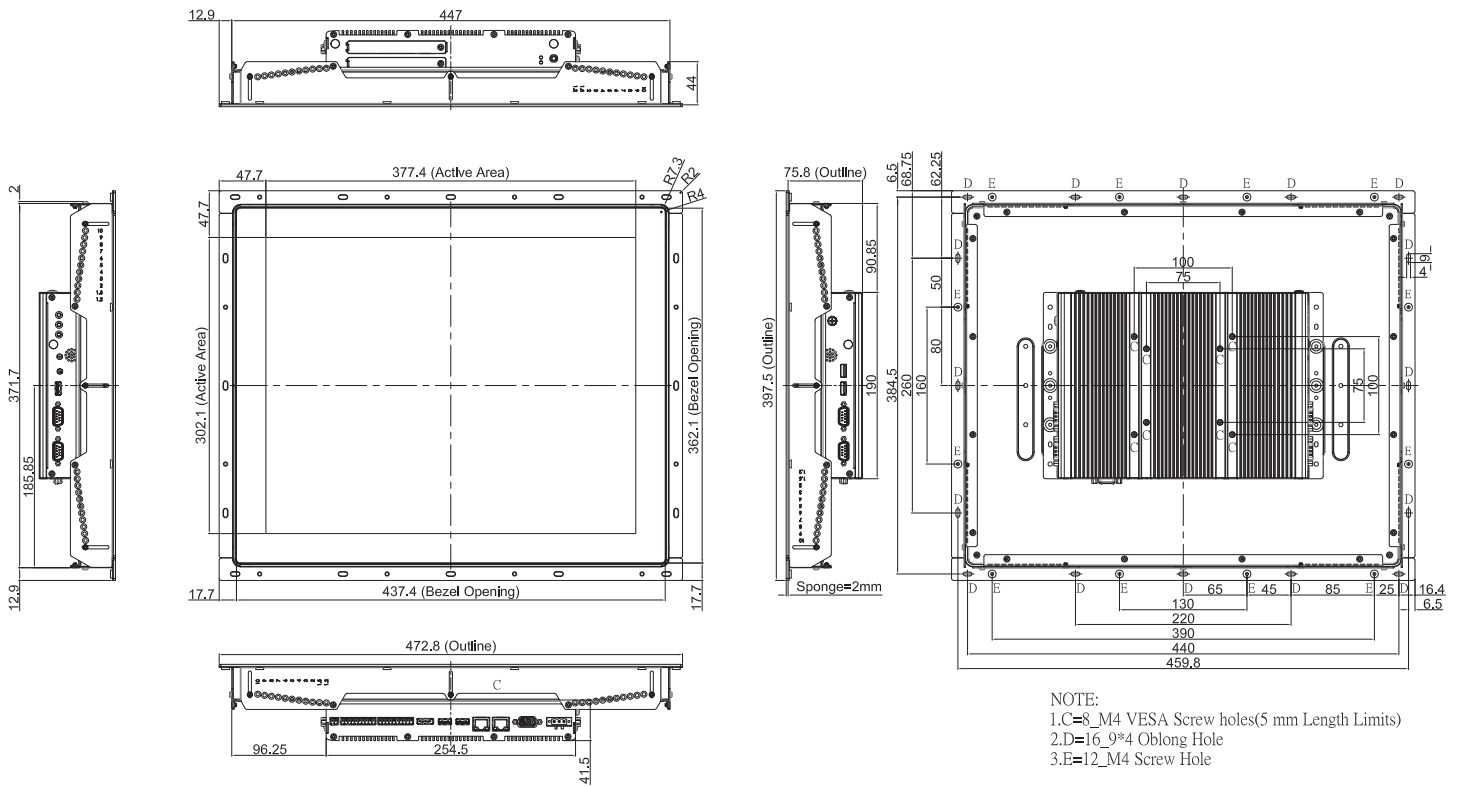

**CO-119C/P2102E Dimensions**

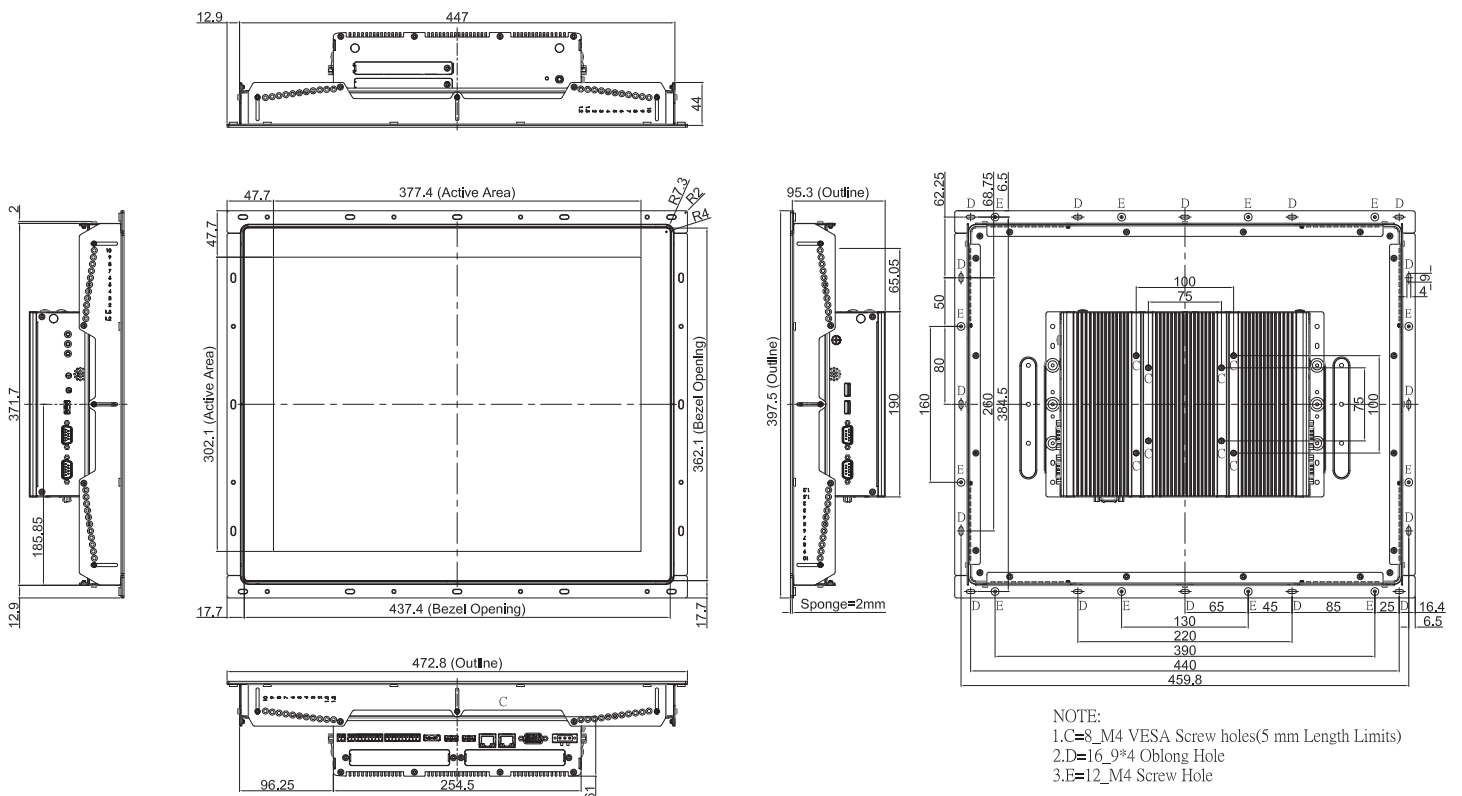



## Ordering Information

### Available Models

Model No.	Description
CO-119C-R10/P2102-i5-R10	19" TFT-LCD SXGA 5:4 Open Frame Display Modular Panel PC with 8th Gen. Intel Core i5-8365UE Quad Core Processor and P-Cap. Touch
CO-119C-R10/P2102E-i5-R10	19" TFT-LCD SXGA 5:4 Open Frame Display Modular and Expandable Panel PC with 8th Gen. Intel Core i5-8365UE Quad Core Processor and P-Cap. Touch
CO-119C-R10/P2102-i3-R10	19" TFT-LCD SXGA 5:4 Open Frame Display Modular Panel PC with 8th Gen. Intel Core i3-8145UE Dual Core Processor and P-Cap. Touch
CO-119C-R10/P2102E-i3-R10	19" TFT-LCD SXGA 5:4 Open Frame Display Modular and Expandable Panel PC with 8th Gen. Intel Core i3-8145UE Dual Core Processor and P-Cap. Touch

### Model Configuration

	CO-119C	P2102 (i3/i5)	P2102E (i3/i5/E4/PI)
CO-119C/P2102	V	V	--
CO-119C/P2102E	V	--	V

V : Compatible

### Package Checklist

• CO-119C/P2102 Series Panel PC x 1	• Thermal Pad (for CPU Thermal Block) x 1
• Power Terminal Block Connector x 1	• Screw Pack x 5
• PCI / PCIe Card Installation Kit x 1	• Remote Power On/O Terminal Block Connector x 1
• DIO Terminal Block Connector x 2	

### Optional Modules and Accessories



Model No.	Description
CFM-IGN101	CFM Module with Power Ignition Sensing Control Function, 12V/24V Selectable
CFM-PoE04	PoE Control Function Module, Individual Port 25.5W (For P2102 only)
CFM-PoE05	PoE Control Function Module, Individual Port 25.5W (For P2102E only)
RC-E4-02	Riser Card with 1x PCIe4 Slot (For P2102E only)
RC-PI-02	Riser Card with 1x PCI Slot (For P2102E only)
MEC-COM-M212-DB9	Mini-PCIe Module with 2x RS-232 Serial Ports, 1x Standard DB9 Cable (For P2102E Only)
MEC-COM-M334-TDB9	Mini-PCIe Module with 4x RS-232/422/485 Serial Ports, 2x Thin DB9 Cable (For P2102E Only)
MEC-LAN-M102-30	Mini-PCIe Module with 2x LAN Ports, 2x 30cm (For P2102E Only)
MEC-USB-M102-30	Mini-PCIe Module with 2x USB 3.2 Gen1 Ports (For P2102E Only)
UB1203	Universal Bracket with 2x DB9 Cutout (For P2102E only)
UB1211	Universal Bracket with 2x RJ45 Cutout (For P2102E only)

Model No.	Description
UB1214	Universal Bracket with 2x USB Cutout (For P2102E only)
URM01	Universal 19" Rack Mount Kit for Industrial Panel PC & Industrial Monitor
GST120A24-CIN	Adapter AC/DC 24V 5A 120W, GST120A24-CIN, wide temp(-30°C ~ +70°C), level VI
GST60A12-CIN1	Adapter AC/DC 12V 5A 60W, GST60A12-CIN1, wide temp(-30°C ~ +70°C)

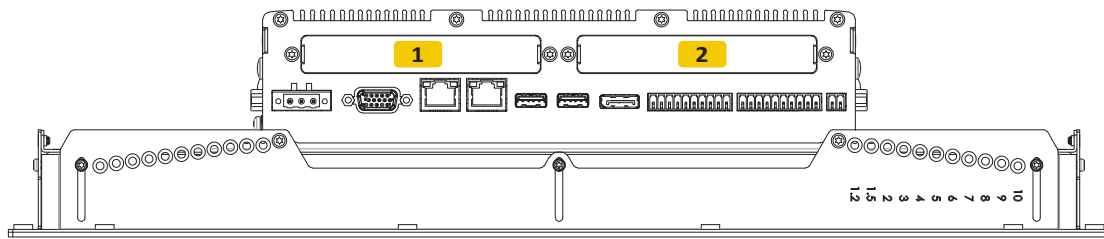
**Optional Module Configuration (For P2102E only)**

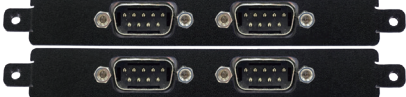

**Model Configuration**

Model No.	Description	1	2
 MEC-COM-M212-TDB9/UB1203	Mini-PCIe Module with 2x COM Ports, 1x Standard DB9 Cable, 2x Universal Bracket each with 1x DB9 Cutout	V	V
 MEC-COM-M334-TDB9/UB1203	Mini-PCIe Module with 4x RS-232/422/485 Serial Ports	V	V
 MEC-LAN-M102-30/UB1211	Mini-PCIe Module with 2x LAN Ports, 2x 30cm cable, w/ 1x Universal Bracket with 2x RJ45 Cutout	V	V
 MEC-USB-M102-30/UB1214	Mini-PCIe Module with 2x USB 3.2 Gen1 Ports, 1x 30cm cable, 1x Universal Bracket with 2x USB Cutout	V	V

V : Compatible