

AFL4-12-EHL

IEI Light Industrial Panel PC

Powered by Intel® Elkhart Lake Platform



AFL4-12-EHL

Fanless panel PC with narrow bezel design, Intel® Celeron® J6412 processor, on-board 8GB memory, HDMI output, dual 2.5GbE LAN, four UART, five USB, two M.2 M key expansion slots, and anti-glare & anti-UV 10-point touchscreen



Intel® Celeron® J6412 SoC

Intel® Elkhart Lake low power SoC, adopting 10nm process, 4-core 4-thread, 2.00GHz base frequency and up to 2.60GHz burst frequency.

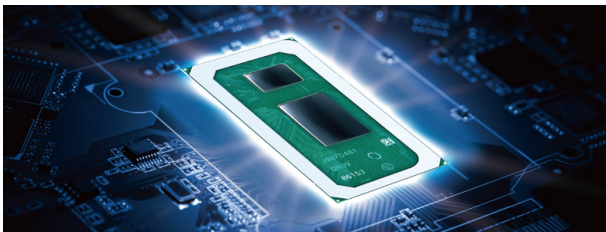

Support 4K UHD Display Output

10th generation Intel® Ultra HD graphics engine allows the system to display video and images in stunning 4K resolution over HDMI 1.4b

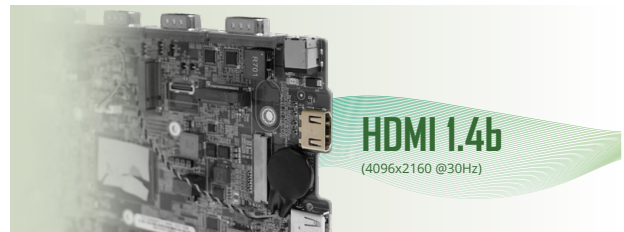

Anti-glare and Anti-UV PCAP

With anti-glare and anti-UV coating, the 10-point touchscreen can display clearly without reflection for a long time use in outdoors and bright light environment.



Works with Gloves and Water

The equipped capacitive touch screen supports gloved operation and waterproof function that can effectively eliminate false touch operating caused by water spray.



Extensive I/O Interfaces

The panel PC is small, but comes with abundant I/O for a variety of application scenarios. It includes four UART, five USB, two 2.5G network port and one HDMI interface.



Support WiFi 6E and Bluetooth 5.2

Strong Wi-Fi 6E wireless network capability provides more bandwidth, and the low latency Bluetooth 5.2 connection is more stable and consumes less power.



AFL4-12-EHL I/O

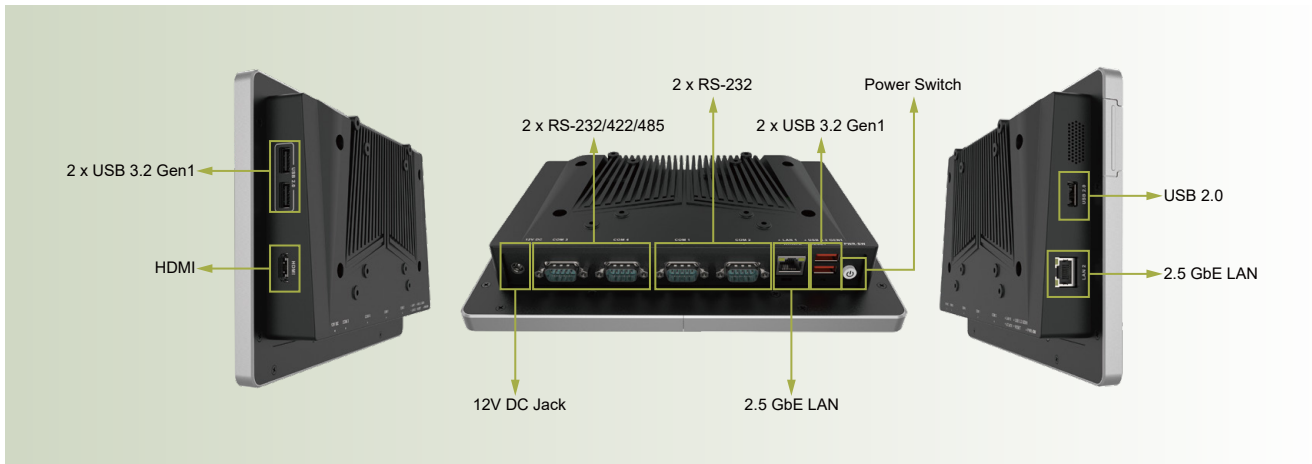

AFL4-12-EHL Block Diagram

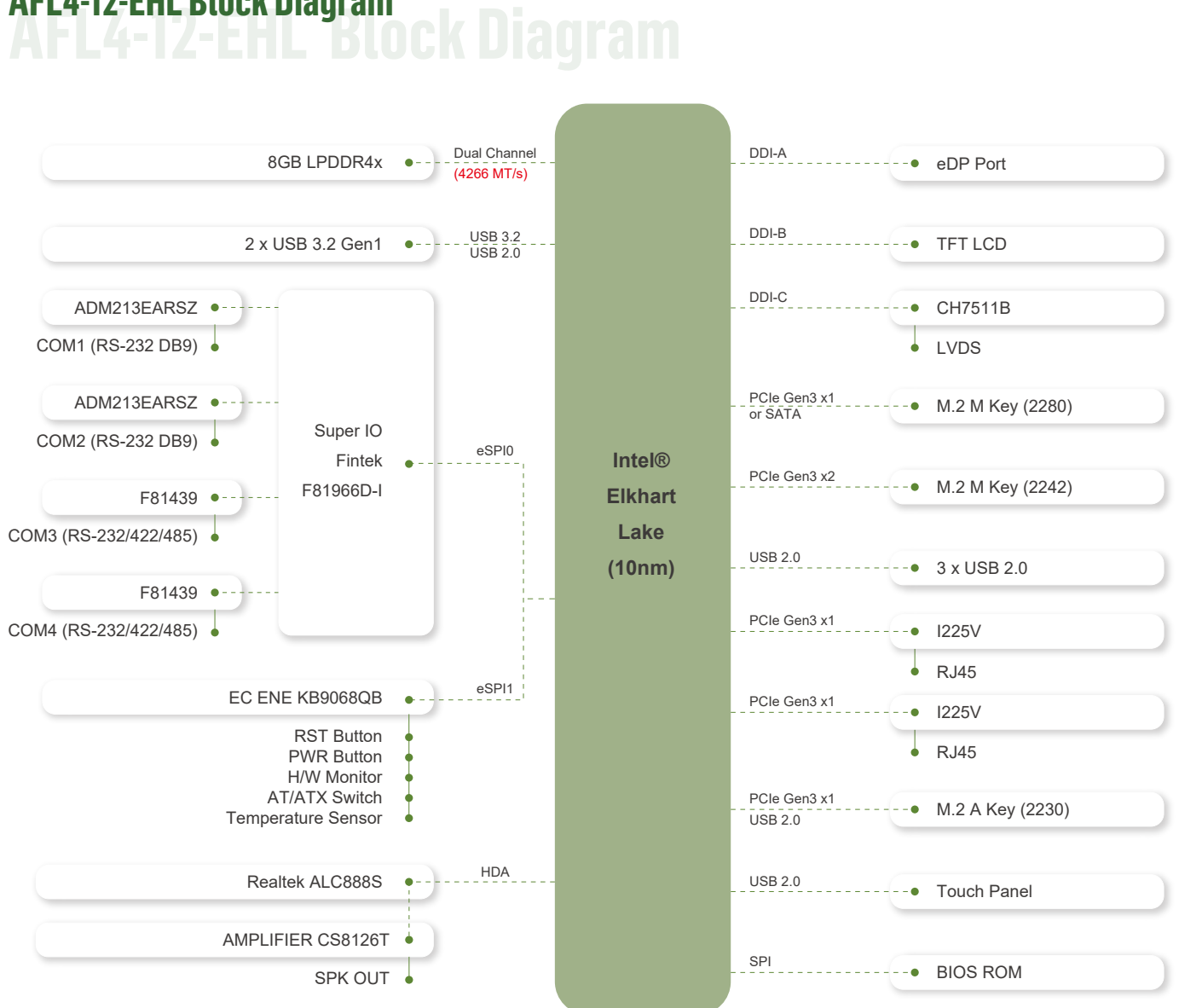

Display System

Dimensions

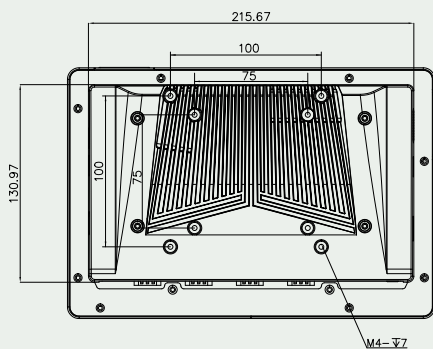
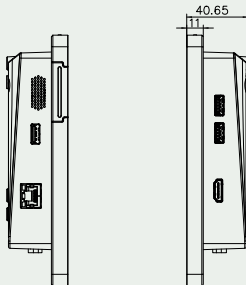
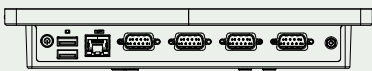
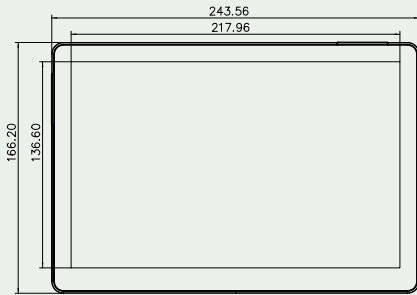
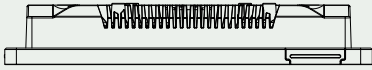

Specifications

Model	AFL4-12-EHL			
LCD	LCD Size	12.1" (4:3)		
	Resolution (WxH)	1024 x 768		
	Brightness (cd/m ²)	500		
	LCD Color	16.7M		
	Pixel Pitch (mm)	0.24 x 0.24		
	Contrast Ratio	700:1		
	Viewing Angle (H-V)	160°/140°		
	Backlight MTBF	50,000 hours		
Touch Panel	Touch Screen	PCAP with USB interface (anti-UV/AG coating)		
	Touch IC	EETI EXC 81 Series		
Motherboard	SoC	Intel® Celeron® Processor J6412 1.5M Cache, up to 2.60 GHz / TDP 10W		
	RAM	Dual channel 8GB LPDDR4x on board		
	Ethernet	LAN1: Intel® I225V 2.5GbE controller LAN2: Intel® I225V 2.5GbE controller		
	Audio Codec	Realtek ALC888S		
	Expansion & Storage	1 x M.2 M key 2242 (PCIe Gen3 x1 or SATA) 1 x M.2 M key 2280 (PCIe Gen3 x2)		
	I/O Port & Switch		2 x RS-232 by DB9 2 x RS-232/422/485 by DB9 2 x 2.5GbE LAN 2 x USB 3.2 Gen1 3 x USB 2.0 1 x HDMI output 1 x 12V DC jack 1 x Power button 1 x Reset button 1 x AT/ATX switch	
		Speaker	AMP 1.2W (internal speaker)	
		Wireless & Bluetooth	IEEE 802.11ax 2T2R module (Wi-Fi 6E) with BT v5.2 (M.2 2230 A-key)	
		Physical	Body Material	Aluminum die casting
			Mounting	Wall, Stand, Arm, VESA 75/100
Color			Silver+Black	
Environment		Operating Temperature (°C)	-10 ~ 50	
	Storage Temperature (°C)	-20 ~ 60		
	Humidity	10% to 95% (non-condensing)		
	Safety & EMC	CE/EMC, UKCA, FCC, RED (Class A)		
	Thermal Solution	Fanless		
	Power	12V		
	ErP	ErP 2009/125/EC		
OS	Windows IoT / Linux			

Packing List

1 x Power Cord	1 x Power Adapter	1 x QIG
----------------	-------------------	---------

Ordering Information

AFL4-12-EHL-J1 /8G-R10	12.1" 500cd/m ² 1024x768 fanless panel PC with Intel® Celeron® J6412 (10W) on-board processor, 8GB LPDDR4x on-board, Wi-Fi 6E and Bluetooth 5.2 module, PCAP touch, R10
------------------------	------------------------------------------------------------------------------------------------------------------------------------------------------------------------------------

Options

Item	Part No	Description
Arm	ARM-11-RS	VESA 75/100 Desk Arm
Stand	STAND-C12-R10	VESA 75/100 Easy Stand
V-Stand	VSTAND-A10-R11	Stand V Type for AFL series, VESA 75/100
Wall	AFLWK-19B	Monitor Wall Mount Kit
OS	WIN10-IOTE2019-E-RS	Win10 IoT Ent LTSC 2019 MultiLang OEI Entry