

# AFL4-W10-EHL

## IEI Light Industrial Panel PC

Powered by Intel® Elkhart Lake Platform



# AFL4-W10-EHL

Fanless panel PC with narrow bezel design, Intel® Celeron® J6412 processor, on-board 8GB memory, HDMI output, dual 2.5GbE LAN, four UART, five USB, two M.2 M key expansion slots, and anti-glare & anti-UV 10-point touchscreen



## Intel® Celeron® J6412 SoC

Intel® Elkhart Lake low power SoC, adopting 10nm process, 4-core 4-thread, 2.00GHz base frequency and up to 2.60GHz burst frequency.

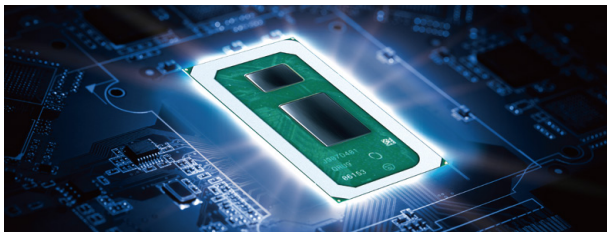

## FHD Touch Display with Optical Bonding

Full HD LCD and high transmission touch screen using optical lamination process to bring great readability and image clarity.



## Support WiFi 6E and Bluetooth 5.2

Strong Wi-Fi 6E wireless network capability provides more bandwidth, and the low latency Bluetooth 5.2 connection is more stable and consumes less power.



## Works with Gloves and Water

The equipped capacitive touch screen supports gloved operation and waterproof function that can effectively eliminate false touch operating caused by water spray.



## Extensive I/O Interfaces

The panel PC is small, but comes with abundant I/O for a variety of application scenarios. It includes four UART, five USB, two 2.5G network port and one HDMI interface.



## Anti-glare and Anti-UV PCAP

With anti-glare and anti-UV coating, the 10-point touchscreen can display clearly without reflection for a long time use in outdoors and bright light environment.



# AFL4-W10-EHL I/O

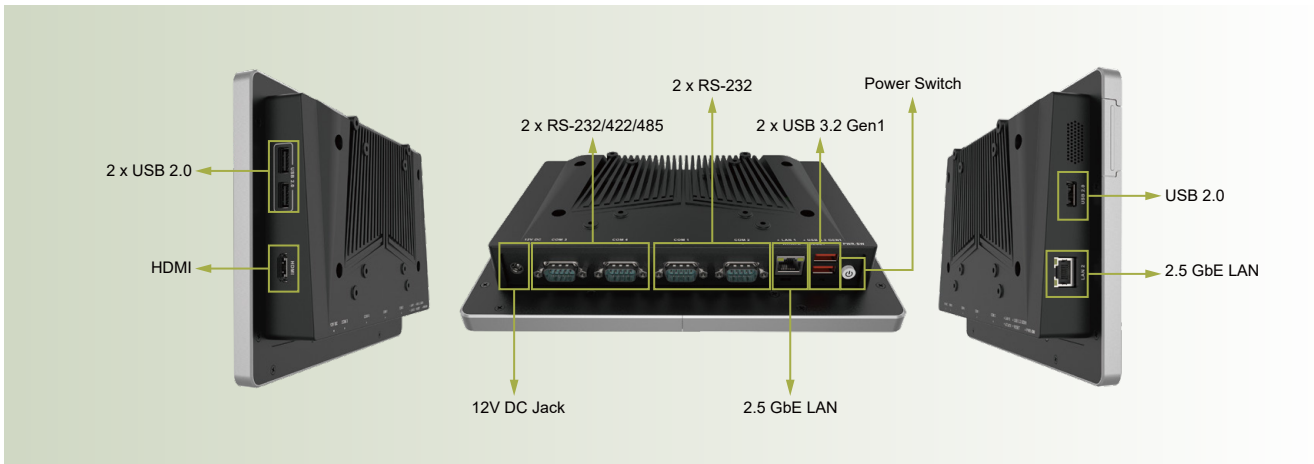

## AFL4-W10-EHL Block Diagram

# AFL4-W10-EHL Block Diagram

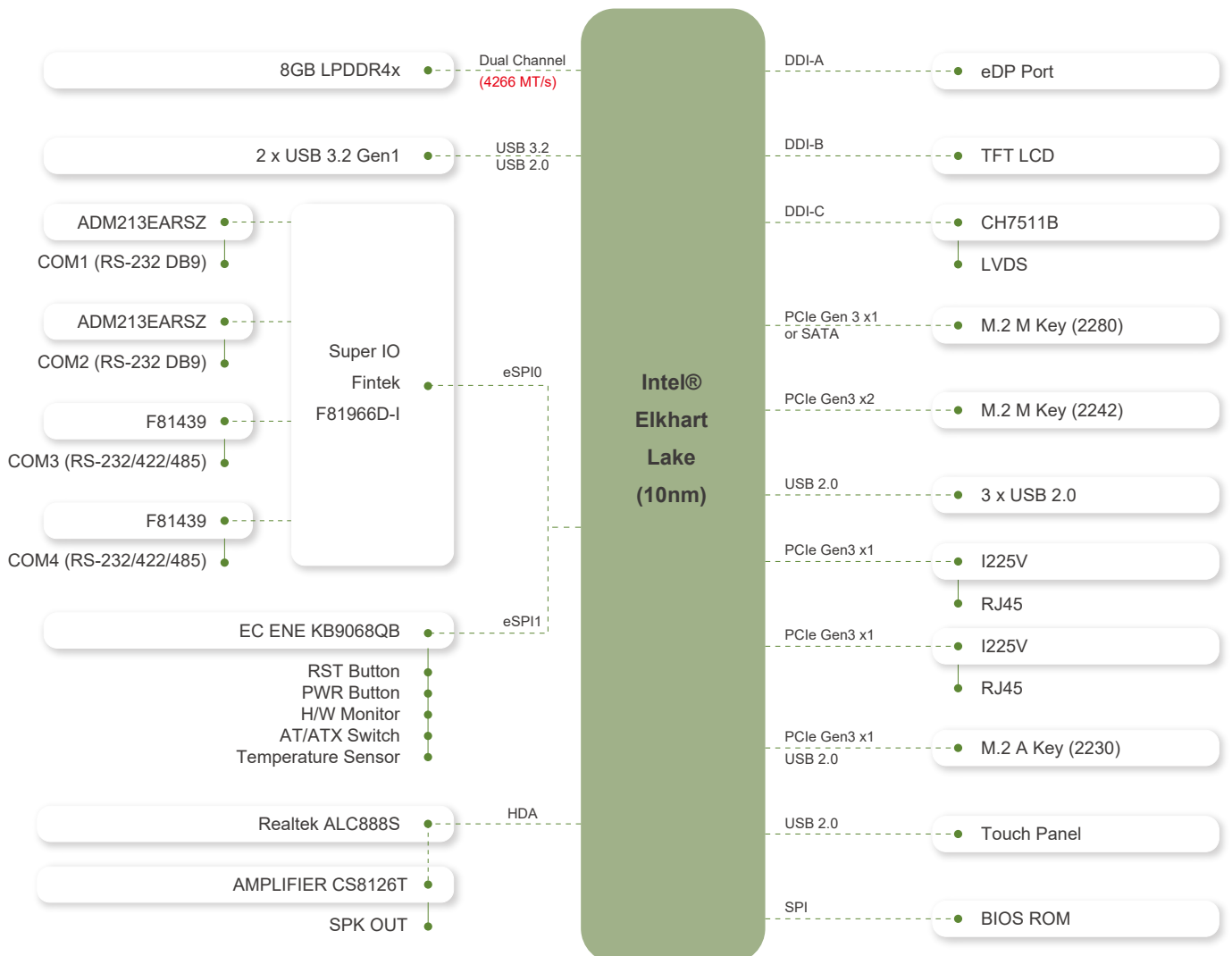

## Dimensions

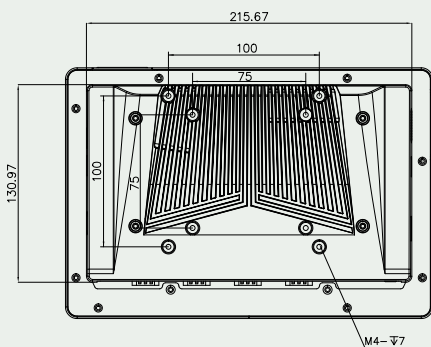
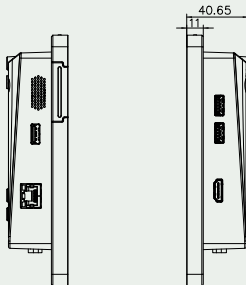
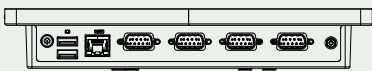
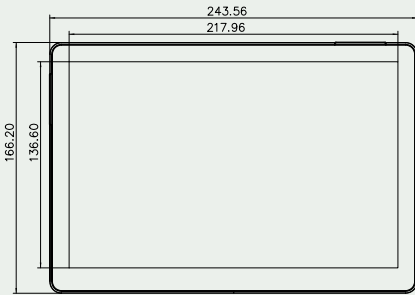

## Specifications

Model	AFL4-W10-EHL		
LCD	LCD Size	10.1" (16:10)	
	Resolution (WxH)	1280 x 800	
	Brightness (cd/m <sup>2</sup> )	350	
	LCD Color	16.7M	
	Pixel Pitch (mm)	0.1695 x 0.1695	
	Contrast Ratio	900:1	
	Viewing Angle (H-V)	170°/170°	
Touch Panel	Backlight MTBF	30000 hours	
	Touch Screen	PCAP with USB interface (anti-UV/AG coating)	
Motherboard	Touch IC	EETI EXC 81 Series	
	SoC	Intel® Celeron® Processor J6412 1.5M Cache, up to 2.60 GHz / TDP 10W	
	RAM	Dual channel 8GB LPDDR4x on board	
	Ethernet	LAN1: Intel® I225V 2.5GbE controller LAN2: Intel® I225V 2.5GbE controller	
	Audio Codec	Realtek ALC888S	
	Expansion & Storage	1 x M.2 M key 2242 (PCIe Gen3 x1 or SATA) 1 x M.2 M key 2280 (PCIe Gen3 x2)	
	I/O Port & Switch		2 x RS-232 by DB9 2 x RS-232/422/485 by DB9 2 x 2.5GbE LAN 2 x USB 3.2 Gen1 3 x USB 2.0 1 x HDMI output 1 x 12V DC jack 1 x Power button 1 x Reset button 1 x AT/ATX switch
		Speaker	AMP 1.2W (internal speaker)
		Wireless & Bluetooth	IEEE 802.11ax 2T2R module (Wi-Fi 6E) with BT v5.2 (M.2 2230 A-key)
		Physical	Body Material
Mounting			Wall, Stand, Arm, VESA 75/100
Color			Silver+Black
Environment		Operating Temperature (°C)	-10 ~ 50
	Storage Temperature (°C)	-20 ~ 60	
	Humidity	10% to 95% (non-condensing)	
	Safety & EMC	CE/EMC, UKCA, FCC, RED (Class A)	
	Thermal Solution	Fanless	
	Power	12V	
OS	ErP	ErP 2009/125/EC	
		Windows IoT / Linux	

## Packing List

1 x Power Cord	1 x Power Adapter	1 x QIG
----------------	-------------------	---------

## Ordering Information

AFL4-W10-EHL-J1 /8G-R10	10.1" 350cd/m <sup>2</sup> 1280x800 fanless panel PC with Intel® Celeron® J6412 (10W) on-board processor, 8GB LPDDR4x on-board, Wi-Fi 6E and Bluetooth 5.2 module, PCAP touch, R10
-------------------------	--

## Options

Item	Part No	Description
Arm	ARM-11-RS	VESA 75/100 Desk Arm
Stand	STAND-C12-R10	VESA 75/100 Easy Stand
V-Stand	VSTAND-A10-R11	Stand V Type for AFL series, VESA 75/100
Wall	AFLWK-19B	Monitor Wall Mount Kit
OS	WIN10-IOTE2019-E-RS	Win10 IoT Ent LTSC 2019 MultiLang OEI Entry