

cincoze

DX-1100 Series

User Manual



Rugged Workstation

9/8th Generation Intel® Xeon® and Core™ Processors,
Extreme Performance, Compact and Modular Rugged
Workstation

Version: V1.47

Contents

Preface

Revision.....	05
Copyright Notice.....	05
Acknowledgement.....	05
Disclaimer.....	05
Declaration of Conformity.....	05
Product Warranty Statement	06
Technical Support and Assistance.....	07
Conventions Used in this Manual	08
Safety Precaution	08
Package Contents	09
Ordering Information	09

Chapter 1 Product Introductions

1.1 Overview	11
1.2 Highlights	11
1.3 Product Pictures.....	12
1.4 Key Features	12
1.5 Hardware Specification	13
1.6 System I/O	14
1.6.1 Front	14
1.6.2 Rear	15
1.7 Mechanical Dimension	16

Chapter 2 Switches and Connectors

2.1 Location of Switches and Connectors	18
2.1.1 Top View	18
2.1.2 Bottom View	19
2.2 Switches and Connectors Definition.....	20
2.3 Definition of Switches.....	21
2.4 Definition of Connectors	22

Chapter 3 System Setup

3.1 Removing the Top Cover	29
3.2 Installing CPU	32
3.3 Installing SO-DIMM Memory.....	35
3.4 Installing a Mini-PCIe/mSATA Card.....	36
3.5 Installing Antennas	37
3.6 Installing Thermal Pad.....	39

3.7 Installing Top Cover.....	39
3.8 Installing Bottom Cover.....	40
3.9 Removing the Front Cover Plate.....	41
3.10 Installing a SATA Hard Drive at Front Side.....	41
3.11 Installing a SIM Card.....	44
3.12 Installing the CMOS Battery.....	45
3.13 Fastening the Cover.....	47
3.14 Installing an External Fan.....	47
3.15 Wall Mount Brackets.....	50
3.16 DIN-Rail Mount Brackets.....	51
3.17 VESA Mount.....	52
3.18 Side Mount Brackets.....	54

Chapter 4 BIOS Setup

4.1 BIOS Introduction	57
4.2 Main Setup	58
4.2.1 System Date	58
4.2.2 System Time	58
4.3 Advanced Setup	59
4.3.1 CPU Configuration	59
4.3.2 SATA And RST Configuration.....	60
4.3.3 PCH-FW Configuration.....	61
4.3.4 Trusted Computing Settings.....	61
4.3.5 ACPI Settings.....	62
4.3.6 F81866 Super IO Configuration.....	63
4.3.7 Hardware Monitor.....	64
4.3.8 S5 RTC Wake Settings.....	65
4.3.9 Serial Port Console Redirection.....	66
4.3.10 USB Configuration.....	66
4.3.11 Network Stack Configuration	67
4.3.12 CSM Configuration.....	68
4.4 Chipset Setup	69
4.4.1 System Agent (SA) Configuration	69
4.4.2 PCH-IO Configuration	70
4.5 Security Setup	72
4.5.1 Administrator Password	72
4.5.2 User Password	72
4.5.3 Security Boot.....	72
4.6 Boot Setup	73
4.6.1 Setup Prompt Timeout.....	73
4.6.2 Bootup NumLock State.....	73

4.6.3 Quiet Boot	73
4.6.4 Fast Boot	73
4.7 Save & Exit	74
4.7.1 Save Changes and Exit	74
4.7.2 Discard Changes and Exit	74
4.7.3 Save Changes and Reset	74
4.7.4 Discard Changes and Reset.....	74
4.7.5 Save Changes	74
4.7.6 Discard Changes	74
4.7.7 Restore Defaults	74
4.7.8 Save as User Defaults	74
4.7.9 Restore User Defaults	74

Chapter 5 Product Application (For DIO Only)

5.1 Digital I/O (DIO) application	76
5.1.1 Digital I/O Programming Guide	76
5.2 Digital I/O (DIO) Hardware Specification	82
5.2.1 DIO Connector Definition	83

Chapter 6 Optional Modules

6.1 CMI-COM Connector Definition and Settings.....	86
6.2 CMI-M12 Connector Definition and Settings.....	87
6.3 CFM-IGN Switch Definition and Settings.....	88
6.4 Installing a CMI-COM Module.....	89
6.5 Installing a CMI-DIO Module.....	91
6.6 Installing a High Speed CMI Module.....	93
6.7 Installing a CFM-PoE Module.....	101
6.8 Installing a CFM-IGN Power Ignition Module.....	105

Preface

Revision

Revision	Description	Date
1.00	New Release	2019/02/11
1.10	Add E-Mark Certified	2019/08/07
1.20	Update the Supporting Capacity of Memory to the latest	2019/11/08
1.30	Correction Made	2019/12/18
1.40	Add the latest supported processors	2019/12/31
1.41	Correction Made	2020/04/09
1.42	New Format Updated	2020/09/01
1.43	Correction Made	2020/11/13
1.44	LVD Number Updated	2021/02/09
1.45	Add DC_IN1 Warning	2021/04/20
1.46	Correction Made	2021/06/28
1.47	Add CMI-XM12LAN01-R10 installation steps	2021/07/26

Copyright Notice

© 2019 by Cincoze Co., Ltd. All rights are reserved. No parts of this manual may be copied, modified, or reproduced in any form or by any means for commercial use without the prior written permission of Cincoze Co., Ltd. All information and specification provided in this manual are for reference only and remain subject to change without prior notice.

Acknowledgement

Cincoze is a registered trademark of Cincoze Co., Ltd. All registered trademarks and product names mentioned herein are used for identification purposes only and may be trademarks and/or registered trademarks of their respective owners.

Disclaimer

This manual is intended to be used as a practical and informative guide only and is subject to change without notice. It does not represent a commitment on the part of Cincoze. This product might include unintentional technical or typographical errors. Changes are periodically made to the information herein to correct such errors, and these changes are incorporated into new editions of the publication.

Declaration of Conformity



FCC

This equipment has been tested and found to comply with the limits for a Class A digital device, pursuant to Part 15 of the FCC Rules. These limits are designed to provide reasonable protection against harmful interference when

the equipment is operated in a commercial environment. This equipment generates, uses, and can radiate radio frequency energy and, if not installed and used in accordance with the instruction manual, may cause harmful interference to radio communications. Operation of this equipment in a residential area is likely to cause harmful interference in which case the user will be required to correct the interference at his own expense.



CE

The product(s) described in this manual complies with all application European Union (CE) directives if it has a CE marking. For computer systems to remain CE compliant, only CE-compliant parts may be used. Maintaining CE compliance also requires proper cable and cabling techniques.

Product Warranty Statement

Warranty

Cincoze products are warranted by Cincoze Co., Ltd. to be free from defect in materials and workmanship for 2 years from the date of purchase by the original purchaser. During the warranty period, we shall, at our option, either repair or replace any product that proves to be defective under normal operation. Defects, malfunctions, or failures of the warranted product caused by damage resulting from natural disasters (such as by lightning, flood, earthquake, etc.), environmental and atmospheric disturbances, other external forces such as power line disturbances, plugging the board in under power, or incorrect cabling, and damage caused by misuse, abuse, and unauthorized alteration or repair, and the product in question is either software, or an expendable item (such as a fuse, battery, etc.), are not warranted.

RMA

Before sending your product in, you will need to fill in Cincoze RMA Request Form and obtain a RMA number from us. Our staff is available at any time to provide you with the most friendly and immediate service.

■ RMA Instruction

- Customers must fill in Cincoze Return Merchandise Authorization (RMA) Request Form and obtain a RMA number prior to returning a defective product to Cincoze for service.
- Customers must collect all the information about the problems encountered and note anything abnormal and describe the problems on the “Cincoze Service Form” for the RMA number apply process.
- Charges may be incurred for certain repairs. Cincoze will charge for repairs to products whose warranty period has expired. Cincoze will also charge for repairs to products if the damage resulted from acts of God, environmental or atmospheric disturbances, or other external forces through misuse, abuse, or unauthorized alteration or repair. If charges will be incurred for a repair,

Cincoze lists all charges, and will wait for customer's approval before performing the repair.

- Customers agree to ensure the product or assume the risk of loss or damage during transit, to prepay shipping charges, and to use the original shipping container or equivalent.
- Customers can be sent back the faulty products with or without accessories (manuals, cable, etc.) and any components from the system. If the components were suspected as part of the problems, please note clearly which components are included. Otherwise, Cincoze is not responsible for the devices/parts.
- Repaired items will be shipped along with a "Repair Report" detailing the findings and actions taken.

Limitation of Liability

Cincoze' liability arising out of the manufacture, sale, or supplying of the product and its use, whether based on warranty, contract, negligence, product liability, or otherwise, shall not exceed the original selling price of the product. The remedies provided herein are the customer's sole and exclusive remedies. In no event shall Cincoze be liable for direct, indirect, special or consequential damages whether based on contract of any other legal theory.

Technical Support and Assistance

1. Visit the Cincoze website at www.cincoze.com where you can find the latest information about the product.
2. Contact your distributor or our technical support team or sales representative for technical support if you need additional assistance. Please have following information ready before you call:
 - Product name and serial number
 - Description of your peripheral attachments
 - Description of your software (operating system, version, application software, etc.)
 - A complete description of the problem
 - The exact wording of any error messages

Conventions Used in this Manual



WARNING

This indication alerts operators to an operation that, if not strictly observed, may result in severe injury.



CAUTION

This indication alerts operators to an operation that, if not strictly observed, may result in safety hazards to personnel or damage to equipment.



NOTE

This indication provides additional information to complete a task easily.

Safety Precautions

Before installing and using this device, please note the following precautions.

1. Read these safety instructions carefully.
2. Keep this User's Manual for future reference.
3. Disconnect this equipment from any AC outlet before cleaning.
4. For plug-in equipment, the power outlet socket must be located near the equipment and must be easily accessible.
5. Keep this equipment away from humidity.
6. Put this equipment on a reliable surface during installation. Dropping it or letting it fall may cause damage.
7. Make sure the voltage of the power source is correct before connecting the equipment to the power outlet.
8. Use a power cord that has been approved for using with the product and that it matches the voltage and current marked on the product's electrical range label. The voltage and current rating of the cord must be greater than the voltage and current rating marked on the product.
9. Position the power cord so that people cannot step on it. Do not place anything over the power cord.
10. All cautions and warnings on the equipment should be noted.
11. If the equipment is not used for a long time, disconnect it from the power source to avoid damage by transient overvoltage.
12. Never pour any liquid into an opening. This may cause fire or electrical shock.
13. Never open the equipment. For safety reasons, the equipment should be opened only

by qualified service personnel.

If one of the following situations arises, get the equipment checked by service personnel:

- The power cord or plug is damaged.
- Liquid has penetrated into the equipment.
- The equipment has been exposed to moisture.
- The equipment does not work well, or you cannot get it work according to the user's manual.
- The equipment has been dropped and damaged.
- The equipment has obvious signs of breakage.

14. CAUTION: Danger of explosion if battery is incorrectly replaced. Replace only with the same or equivalent type recommended by the manufacturer.
15. Equipment intended only for use in a RESTRICTED ACCESS AREA.

Package Contents

Before installation, please ensure all the items listed in the following table are included in the package.

Item	Description	Q'ty
1	Rugged Workstation	1
2	CPU Heatsink Pack	1
3	Utility DVD Driver	1
4	Screw Pack	1
5	Wall Mounting Kit	1
6	Power Terminal Block Connector	1
7	Remote Power On/Off Terminal Block Connector	1
8	Fan Terminal Block Connector	1
9	DVI-I to VGA Adaptor	1

Note: *Notify your sales representative if any of the above items are missing or damaged.*

Ordering Information

Model No.	Product Description
DX-1100-R10	9/8th Generation Intel® Xeon® and Core™ Processors, Extreme Performance, Compact and Modular Rugged Workstation



Chapter 1

Product Introductions

1.1 Overview

The Cincoze DX-1100 is a rugged workstation specifically designed to satisfy demands for the high-performance computing platform. Based on LGA 1151 socket and Intel® C246 chipset, the system supports 9/8th generation Intel Xeon® and Core™ processors (formerly codenamed Coffee Lake S) with up to 8 cores and 64GB memory capacity.

Despite its remarkably compact size, the DX-1100 still delivers the maximum flexibility of modular I/O expansions and provides dual hot-swap 2.5" HDD/SSD tray with RAID function. Thanks to Cincoze' exclusive CFM (Control Function Module) technologies, the DX-1100 can be configured instantly with Power over Ethernet and power ignition sensing functions to be applied in many industrial applications, such as machine vision, in-vehicle transportation, and mobile surveillance.

Featuring rugged construction, fanless/cable-less/jumper-less design, wide operating temperature (-40 to +70°C), wide range DC power input (9~48 VDC), high tolerance to vibration and shock (5/50 Grms), the DX-1100 is maintenance-free and ideal to be deployed in harsh environments.

1.2 Highlights



Workstation Performance & Compact

Supporting 9/8th Gen Intel® Xeon® E-series processors (up to 8-core, 4.7 GHz), the DX-1100 delivers workstation performance available in a compact size for multi-task applications and space-limited environments.

Modular Computing

Based on Cincoze' trusted, innovative, and reliable modular design, the DX-1100 brings the maximum flexibility and allows users to configure I/O interfaces according to specific application requirements.

Application-driven Functions

DX-1100 allows users extend functions and additional I/O interfaces according to their requirements. The available option modules include power ignition sensing, M12 PoE, GbE LAN, COM ports and Digital I/Os.

1.3 Product pictures



Front



Rear

1.4 Key Features

- Supports 9/8th Generation Intel® Xeon® and Core™ Octa-core Processor
- Triple Independent Display with 4K/2K UHD Resolution (HDMI / DP / DVI-I)
- 2x 2.5" Hot Swap SATA HDD/SSD Tray, 3x mSATA Socket
- 2x USB 3.1 (10Gb/s) for Ultimate Data-transfer Speed
- 1x M.2 E Key Socket (CNVi), 3x Full-size Mini-PCIe Socket, 1x SIM Card Socket
- Supports CMI Interface for I/O Expandability
- Supports PoE+ and Power Ignition Sensing (with optional CFM modules)
- Wide Operating Temperature -40°C to 70°C
- E-Mark (E13, No.10R-0515210), LVD EN62368-1, EN50155 / EN50121-3-2

1.5 Hardware Specification

Processor

- 9th Generation Intel® Coffee Lake-R S Series CPU:
 - Intel® Xeon® E-2278GEL 8 Cores Up to 3.9 GHz, TDP 35W
 - Intel® Core™ i7-9700E 8 Cores Up to 4.4 GHz, TDP 65W
 - Intel® Core™ i5-9500E 6 Cores Up to 4.2 GHz, TDP 65W
 - Intel® Core™ i3-9100E 4 Cores Up to 3.7 GHz, TDP 65W
 - Intel® Core™ i7-9700TE 8 Cores Up to 3.8 GHz, TDP 35W
 - Intel® Core™ i5-9500TE 6 Cores Up to 3.6 GHz, TDP 35W
 - Intel® Core™ i3-9100TE 4 Cores Up to 3.2 GHz, TDP 35W
- 8th Generation Intel® Coffee Lake S Series CPU:
 - Intel® Xeon® E-2176G 6 Cores Up to 4.7 GHz - 12M Cache, TDP 80W
 - Intel® Xeon® E-2124G 4 Cores Up to 4.5 GHz - 8M Cache, TDP 71W
 - Intel® Core™ i7-8700 6 Cores Up to 4.6 GHz - 12M Cache, TDP 65W
 - Intel® Core™ i5-8500 6 Cores Up to 4.1 GHz - 9M Cache, TDP 65W
 - Intel® Core™ i3-8100 4 Cores 3.6 GHz - 6M Cache, TDP 65W
 - Intel® Core™ i7-8700T 6 Cores Up to 4.0 GHz - 12M Cache, TDP 35W
 - Intel® Core™ i5-8500T 6 Cores Up to 3.5 GHz - 9M Cache, TDP 35W
 - Intel® Core™ i3-8100T 4 Cores 3.1 GHz - 6M Cache, TDP 35W
 - Intel® Pentium® G5400 2 Cores 3.7 GHz - 4M Cache, TDP 58W
 - Intel® Pentium® G5400T 2 Cores 3.1 GHz - 4M Cache, TDP 35W
 - Intel® Celeron® G4900 2 Cores 3.1 GHz - 2M Cache, TDP 54W
 - Intel® Celeron® G4900T 2 Cores 2.9 GHz - 2M Cache, TDP 35W

Chipset

- Intel® C246

BIOS

- AMI 32MB BIOS

Memory

- 2x DDR4-2666/2400 MHz SO-DIMM Sockets
- Support up to 64 GB (Un-buffered and Non-ECC type)
 - * i3/Pentium/Celeron: DDR4 2400 MHz

Graphics

- Integrated Intel® UHD Graphics
(Xeon: UHD P630; i7/i5/i3: UHD 630; Pentium/Celeron: UHD 610)
- Supports Triple Independent Display (DVI-I/DisplayPort/HDMI)

Audio

- Realtek® ALC888, High Definition Audio

I/O Interface

- 1x DVI-I Connector
(VGA: 1920 x1080 @ 60 Hz; DVI-D: 1920 x1200 @ 60 Hz)
- 1x DisplayPort Connector (3840 x 2160 @30Hz)
- 1x HDMI Connector (3840 x 2160 @30Hz)
- 2x GbE LAN (Support WoL, Teaming, Jumbo Frame, IEEE 1588v2 and PXE), RJ45
 - GbE1: Intel® I219-LM || GbE2: Intel® I210
- 4x RS-232/422/485 with Auto Flow Control (Support 5V/12V), DB9
- 2x USB 3.1 (Type-A)
- 6x USB 3.0 (Type-A)
- 1x Line-out & 1x Mic-in, Phone Jack 3.5mm
- 1x ATX Power On/Off Button
- 1x Reset Button
- 1x AT/ATX Mode Switch
- 1x Clear CMOS Switch
- 1x Remote Power On/Off Connector, 2-pin Terminal Block
- 1x External FAN Connector, 4-pin Terminal Block
(Supports Smart Fan by BIOS)

Storage

- 2x 2.5" Front Accessible SATA HDD/SSD Bay (SATA 3.0)
- 3x mSATA Socket (SATA 3.0, shared by Mini-PCIe socket)
- Supports S/W RAID 0, 1, 5 & 10

Expansion

- 1x Control Function Module (CFM) Interface
- 2x Combined Multiple I/O (CMI) High Speed Interface
- 1x Combined Multiple I/O (CMI) Low Speed Interface
- 1x M.2 2230 Socket (Key E), supports WiFi/Bluetooth module or BIOS Selectable Intel® CNVi (Integrated WiFi/Bluetooth)
- 3x Full-size Mini-PCIe Socket
- 1x SIM Socket
- 3x Antenna Hole

Other Function

- Supports Instant Reboot Technology (0.2 sec)
- SuperCap Integrated for CMOS Battery Maintenance-free Operation
- Watchdog Timer: Software Programmable Supports 256 Levels System Reset

Power Requirement

- Supports AT/ATX Power Type
- Power Input Voltage 9~48VDC
- 1x 3-pin Terminal Block
- Power Adapter AC/DC 24V/5A 120W or 24V/9.2A 220W (Optional)

Physical

- Dimension (WxDxH): 242 x 173 x 77 mm • Weight: 3.6 kg
- Extruded Aluminum with Heavy Duty Metal
- Wall mount / VESA mount / DIN Rail Mount / Side Mount
- Unibody Chassis
- Fanless Design
- Jumper-less Design
- Cable less Design

Protection

- Reverse Power Input Protection
- Over Voltage Protection
 - Protection Range: 51~58V
 - Protection Type: shut down operating voltage, re-power on at the present level to recover
- Over Current Protection: 15A
- ESD Protection: +/-8kV (air), +/-4kV (contact)
- Surge Protection: 3.84 kV (impedance 12 ohm 1.2/50us waveform)

Operating System

- Windows® 10 • Linux: Supports by Project

Environment

- Operating Temperature:
 - 35W TDP Processor: -40°C to 70°C
 - 54~65W TDP Processor: -40°C to 45°C
 - 71~80W TDP Processor: -40°C to 40°C
 - * PassMark BurnInTest: 100% CPU, 2D/3D Graphics(without thermal throttling)
 - * With extended temperature peripherals; Ambient with air flow
 - * According to IEC60068-2-1, IEC60068-2-2, IEC60068-2-14
- Storage Temperature: -40°C to 85°C
- Relative Humidity: 95% RH @ 40°C (Non-condensing)
- Shock: Operating, 50 Grms, Half-sine 11 ms Duration
 - * w/ SSD, according to IEC60068-2-27
- Vibration: Operating, 5 Grms, 5-500 Hz, 3 Axes
 - * w/ SSD, according to IEC60068-2-64
- MTBF: 407,391 Hours
Database: Telcordia SR-332 Issue 3, Method 1, Case 3

Certification

- EMC: CE, FCC Class A
- Safety: LVD (EN62368-1)
- Railway: EN50155, EN50121-3-2
- In-Vehicle: E-Mark (E13, No. 10R-0515210)

1.6 System I/O

1.6.1 Front

ATX Power On/Off

Used to power-on or power-off the system

HDMI Port

Used to connect the system with HDMI monitor

Power LED

Indicates the power status of the system

HDD LED

Indicates the status of the hard drive

IGN LED

Indicates the status of the IGN function

Temperature LED

Indicates the temperature of the system

Universal I/O Bracket

Used to customized I/O output with optional modules

USB 3.1 Port

Used to connect USB 3.1/3.0/2.0/1.1 device

USB 3.0 Port

Used to connect USB 3.0/2.0/1.1 device

IGN Setting Switch

Used to set up IGN function

SIM Card Slot

Used to insert a SIM card

Clear CMOS Switch

Used to clear CMOS to reset BIOS

Reset Button

Used to reset the system

AT/ATX Mode Select Switch

Used to select AT or ATX power mode

Removable 2.5" SATA HDD/SSD Bay

Used to insert a 2.5" SATA HDD/SSD

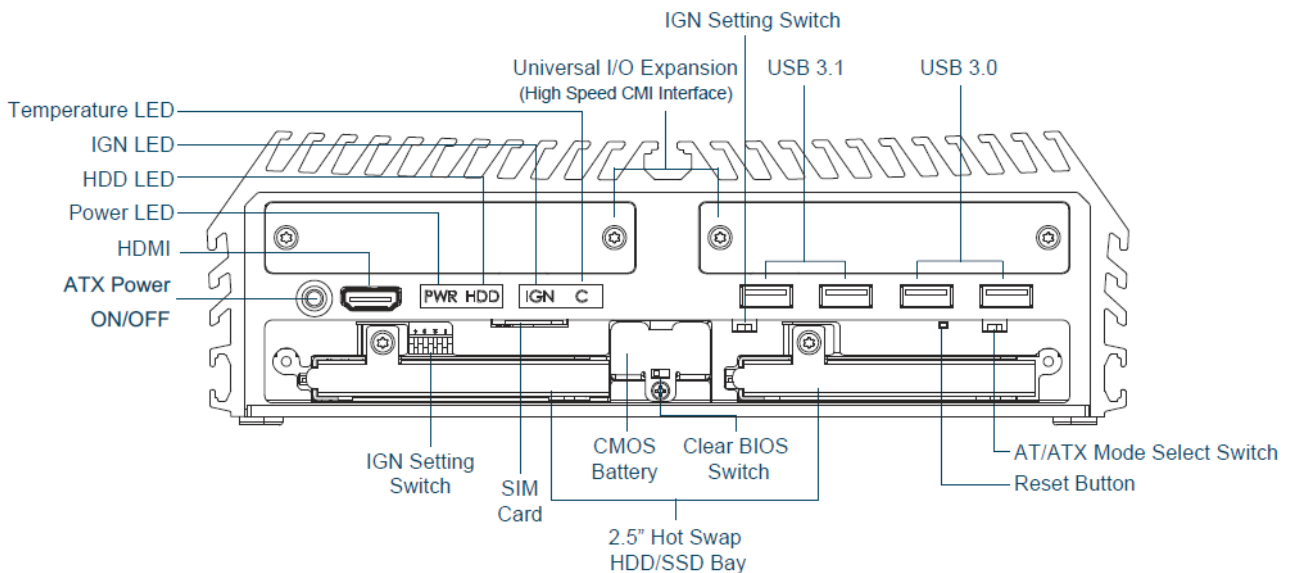

1.6.2 Rear

DC IN Terminal Block

Used to plug a DC power input with terminal block

Antenna Hole

Used to connect an antenna for optional wireless module

LAN Port

Used to connect to local area network

USB 3.0 Port

Used to connect USB 3.0/2.0/1.1 device

DVI-I Port

Used to connect a DVI monitor or connect optional split cable for dual display mode

Display Port

Used to connect a monitor with DisplayPort interface

COM Port

Used to connect to RS-232/422/485 serial devices

Line-Out

Used to connect a speaker

Mic-In

Used to connect a microphone

Remote Power On/Off

A terminal block used to connect to remote power on/off switch

Universal I/O Bracket

Used to customized I/O output with optional modules

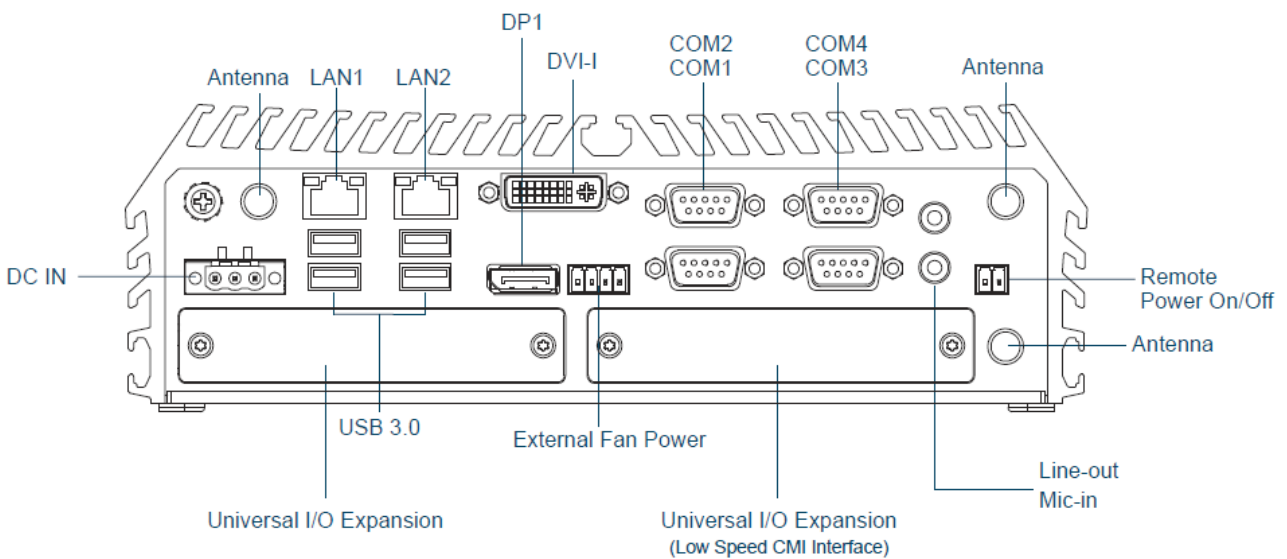

1.7 Mechanical Dimension

Unit: mm

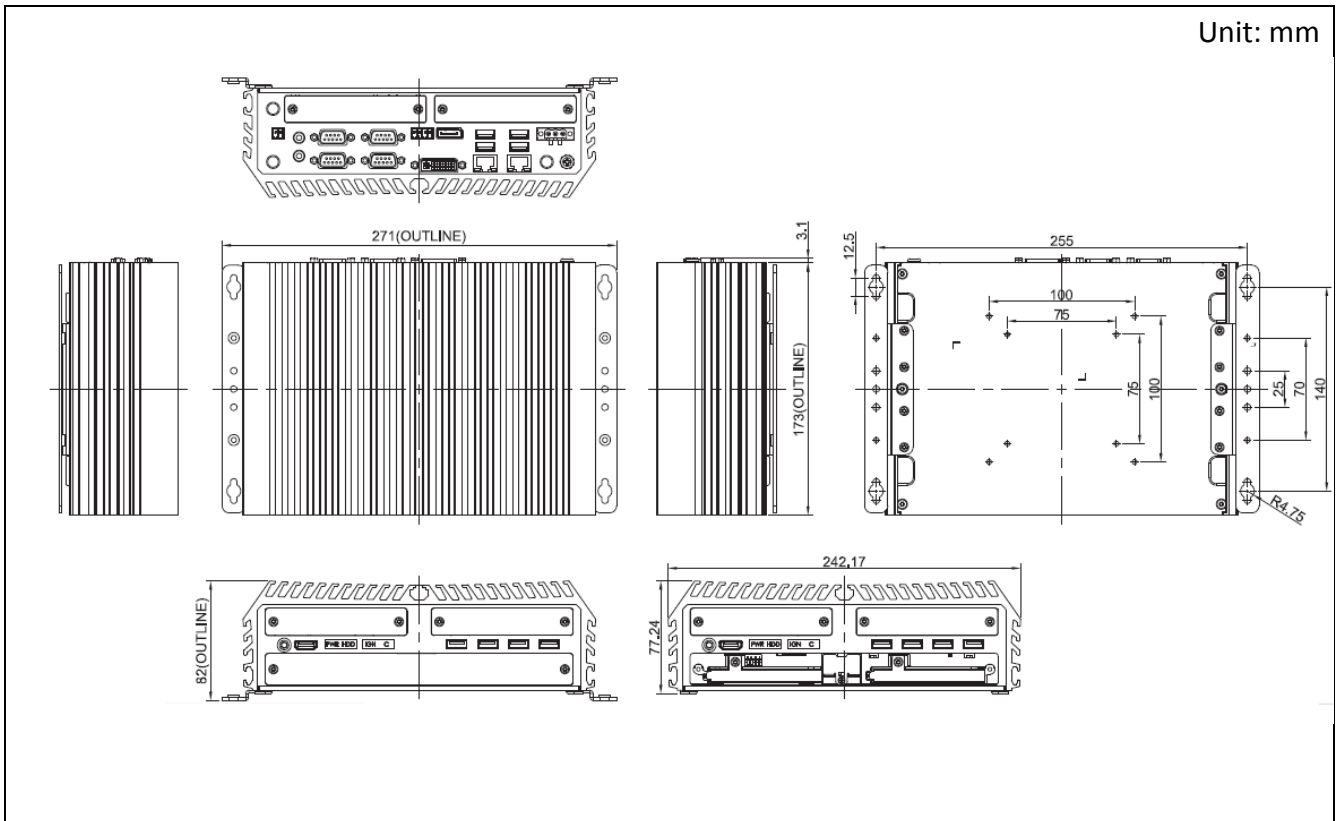



Chapter 2

Switches & Connectors

2.1 Location of Switches and Connectors

2.1.1 Top View

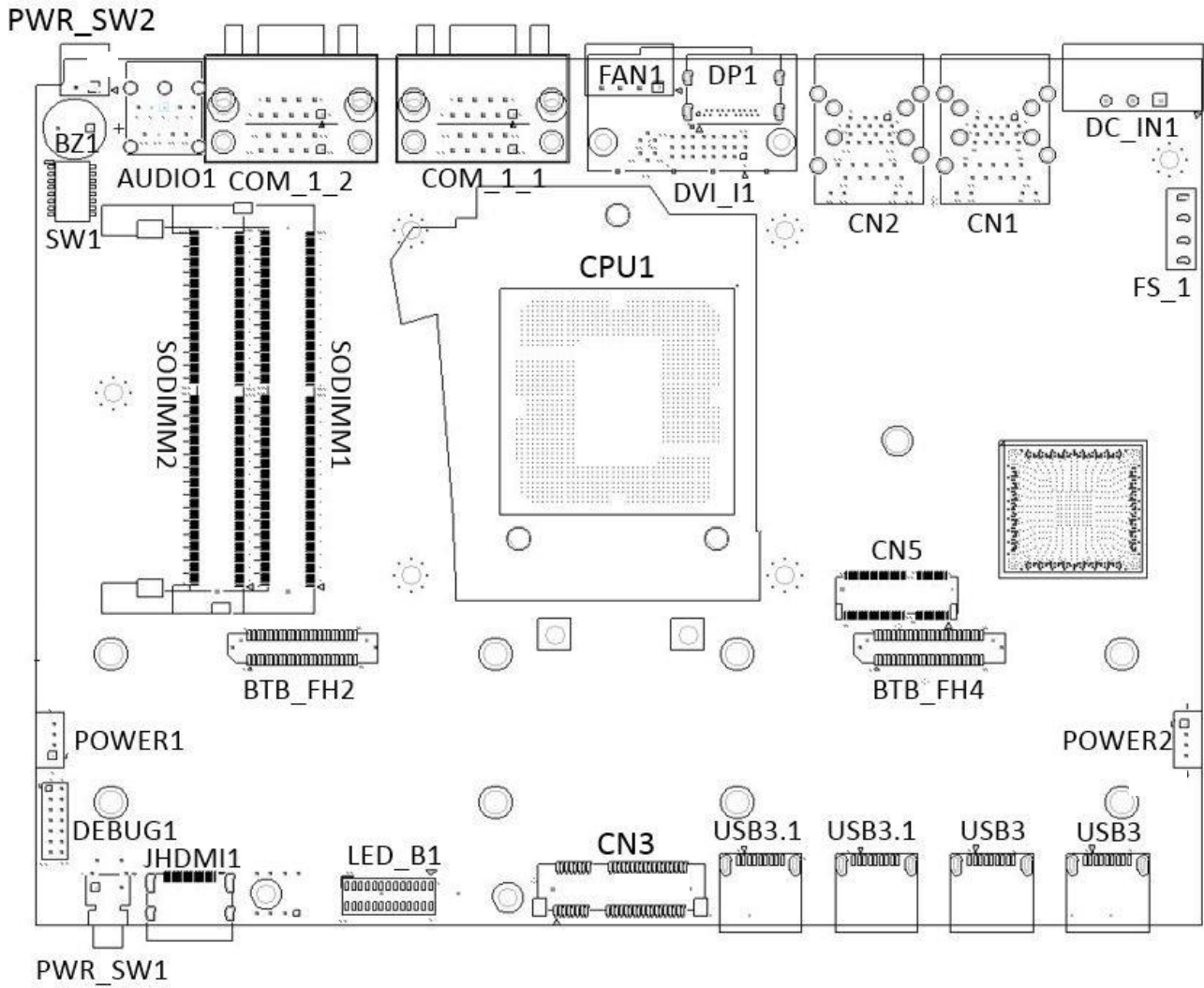

2.1.2 Bottom View

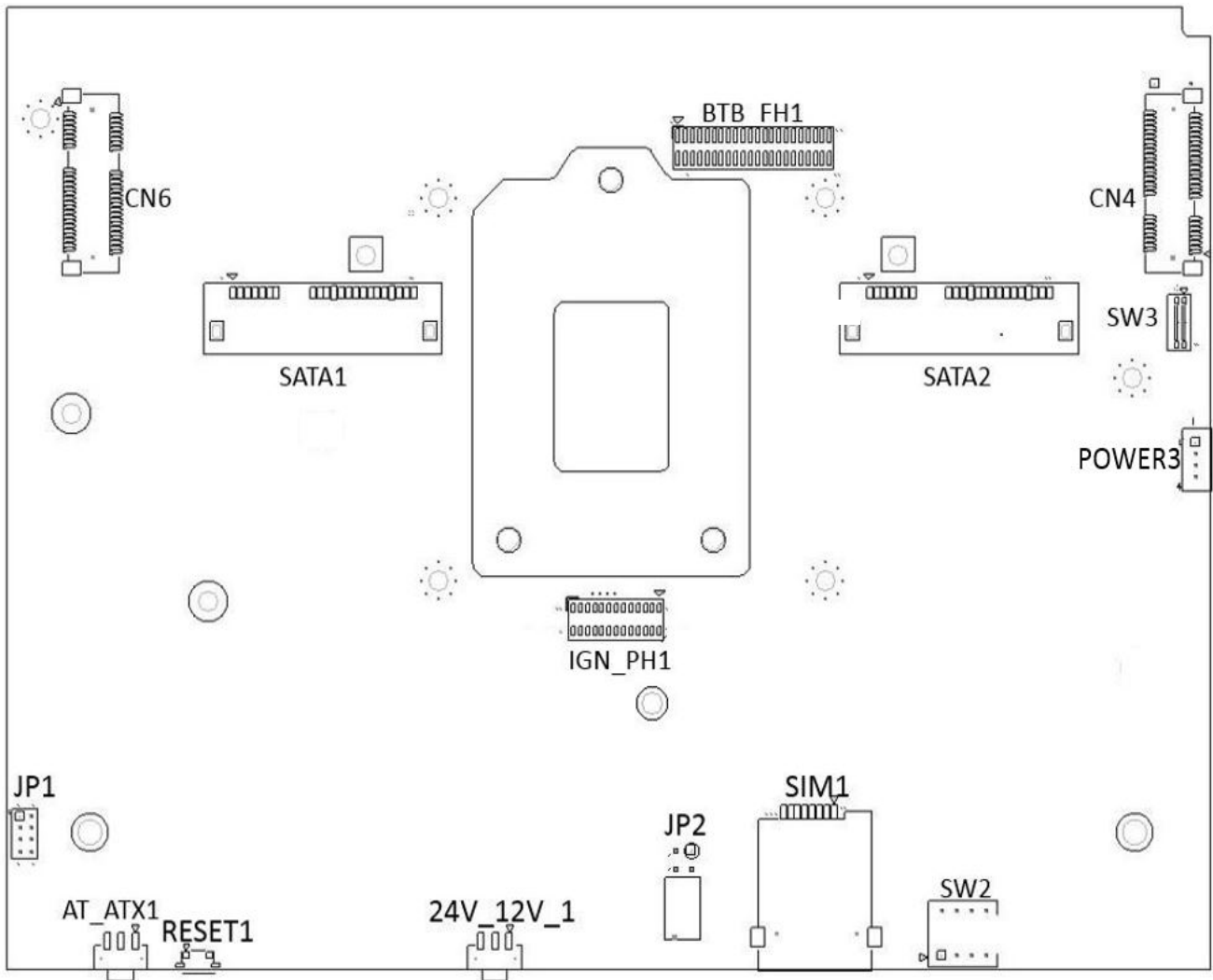

2.2 Switches and Connectors Definition

List of Switch

Location	Definition
AT_ATX1	AT / ATX Power Mode Switch
PWR_SW1	ATX Power on/off Button
SW1	COM1~4 with Power Select Switch
SW2	IGN Module Timing Setting Switch
SW3	Super CAP Switch
24V_12V_1	IGN Module Voltage Mode Setting Switch
Reset1	Reset Button
CLR_CMOS1	Clear BIOS Switch

List of Connector

Location	Definition
SODIMM1,SODIMM2	260-pin SO-DIMM DDR4 Sockets
SATA1, SATA2	22-Pin SATA 3.0 Sockets
CN3	Mini PCI-Express Socket (mPCIe/ mSATA/ 4G Module)
CN4, CN6	Mini PCI-Express Socket (mPCIe/ mSATA)
CN5	M.2 Key E Socket (M.2 PCIE / Intel CNVi)
DC_IN1	3-pin DC 9~48V Power Input with Power Ignition Connector
PWR_SW2	Remote Power on/off Connector
CN1	LAN1 and USB3.0 Connectors
CN2	LAN2 and USB3.0 Connectors
COM1_1, COM1_2	COM1~COM4 RS232 / RS422 / RS485 Connectors
DVI_I1	DVI-I Connector
DP1	DisplayPort Connector
JHDMI1	HDMI Connector
USB3.1	USB 3.1 Ports
USB3.0	USB 3.0 Ports
FAN1	External PWM Fan Connector
AUDIO1	MIC_IN / LINE_OUT Audio Jack
BTB_FH1	CMI Module to Board Connector
BTB_FH2, BTB_FH4	POE LAN Module to Board Connectors
IGN_PH1	IGN Module to Board Connector
Power 1~3	+5V / +12V Power Output Connectors
FS_1	Input Power Fuse 15A Connector
LED_B1	System LED Connector

2.3 Definition of Switches

AT_ATX1: AT / ATX Power Mode Switch

Switch	Definition
1-2 (Left)	AT Power Mode
2-3 (Right)	ATX Power Mode (Default)



PWR_SW1: ATX Power on/off Button

Switch	Definition
Push	Power on System



SW1: COM1/COM2/COM3/COM4 Power Select

COM1 / 2 / 3 / 4 Voltage Function Setting via DIP Switch

Location	Function		DIP1	DIP2
SW1	COM1	0V(RI)	ON (Default)	ON (Default)
		5V	ON	OFF
		12V	OFF	OFF

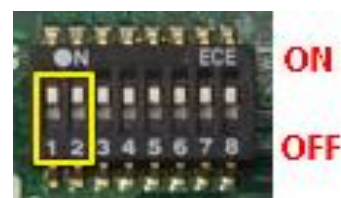

Location	Function		DIP3	DIP4
SW1	COM2	0V(RI)	ON (Default)	ON (Default)
		5V	ON	OFF
		12V	OFF	OFF

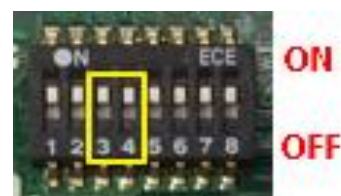

Location	Function		DIP5	DIP6
SW1	COM3	0V(RI)	ON (Default)	ON (Default)
		5V	ON	OFF
		12V	OFF	OFF

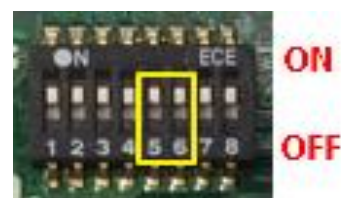

Location	Function		DIP7	DIP8
SW1	COM4	0V(RI)	ON (Default)	ON (Default)
		5V	ON	OFF
		12V	OFF	OFF

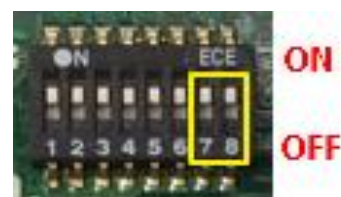

SW3: Super CAP Switch

DIP	Function	ON	OFF
1	Super CAP	Enable (Default)	Disable
2	N/A	N/A	N/A

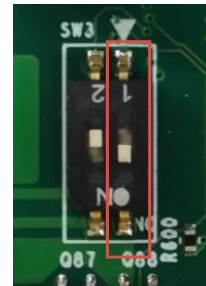

OFF
ON

Reset1: System Reset Button

Button	Definition	Button	Definition
Push	Reset System	Push	Reset System



CLR_CMOS1: Clear CMOS Switch

Pin	Definition
1-2 (Left)	Normal Status (Default)
2-3 (Right)	Clear CMOS



2.4 Definition of Connectors

CN3: Mini PCI-Express Socket (Support mPCIE, mSATA, and SIM Module)

Pin	Definition	Pin	Definition	Pin	Definition
1	WAKE#	19	NA	37	GND
2	+3.3V	20	+3.3V	38	USB_D+
3	NA	21	GND	39	+3.3V
4	GND	22	PERST#	40	GND
5	NA	23	PERXN/SATARXP	41	+3.3V
6	+1.5V	24	+3.3V	42	NA
7	NA	25	PERXP/SATARXN	43	GND
8	SIM_PWR	26	GND	44	NA
9	GND	27	GND	45	CLINK_CLK
10	SIM_DATA	28	+1.5V	46	NA
11	REFCLK-	29	GND	47	CLINK_DATA
12	SIM_CLK	30	SMB_CLK	48	+1.5V
13	REFCLK+	31	PETXN/SATATXN	49	CLINK_RESET
14	SIM_RESET	32	SMB_DATA	50	GND
15	GND	33	PETXP/SATATXP	51	NA
16	SIM_VPP1	34	GND	52	+3.3V
17	NA	35	GND		
18	GND	36	USB_D-		

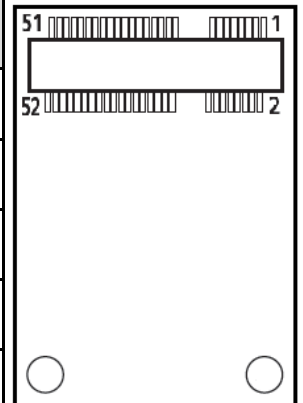

CN4 / CN6 : Mini PCI-Express Socket (Support mPCIE and mSATA)

Pin	Definition	Pin	Definition	Pin	Definition
1	WAKE#	19	NA	37	GND
2	+3.3V	20	+3.3V	38	USB_D+
3	NA	21	GND	39	+3.3V
4	GND	22	PERST#	40	GND
5	NA	23	PERXN/SATARXP	41	+3.3V
6	+1.5V	24	+3.3V	42	NA
7	NA	25	PERXP/SATARXN	43	GND
8	NA	26	GND	44	NA
9	GND	27	GND	45	NA
10	NA	28	+1.5V	46	NA
11	REFCLK-	29	GND	47	NA
12	NA	30	SMB_CLK	48	+1.5V
13	REFCLK+	31	PETXN/SATATXN	49	NA
14	NA	32	SMB_DATA	50	GND
15	GND	33	PETXP/SATATXP	51	NA
16	NA	34	GND	52	+3.3V
17	NA	35	GND		
18	GND	36	USB_D-		

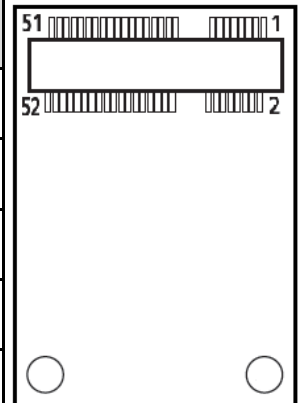

CN5 : M.2 Key E Socket (Support M.2 PCIE / Intel CNVi)

Pin	Definition	Pin	Definition	Pin	Definition
1	GND	27	KEY	53	NC
2	+3.3V	28	KEY	54	PULL-UP
3	USB_D+	29	KEY	55	PEWAKE0#
4	+3.3V	30	KEY	56	NC
5	USB_D-	31	KEY	57	GND
6	NC	32	RGI_DT	58	I2C_DATA
7	GND	33	GND	59	WTD1N/PETP1
8	PCM_CLK	34	RGI_RSP	60	I2C_CLK
9	WGR_D1N	35	PETP0	61	WTD1P/PETN1
10	PCM_SYNC/ LPCRSTN	36	RBI_DT	62	NC
11	WGR_D1N	37	PETN0	63	GND
12	PCM_IN	38	CLINK_REST	64	REF_CLK
13	GND	39	GND	65	WTD0N/PETP1
14	PCM_OUT	40	CLINK_DATA	66	NC
15	WGR_D0N	41	PERP0	67	WTD0P/PERN1
16	NC	42	CLINK_CLK	68	NC
17	WGR_D0P	43	PERN0	69	GND
18	GND	44	COEX3	70	PEWAKE1#
19	GND	45	GND	71	WTCLK/REFCLKP1
20	UART_WAKE	46	COEX_TXD	72	+3.3V
21	WGR_CLKN	47	REFCLKP0	73	WTCLK/REFCLKN1
22	BRI_RSP	48	COEX_RXD	74	+3.3V
23	WGR_CLKP	49	REFCLKN0	75	GND
24	NC	50	SUSCLK		
25	PETP2	51	GND		
26	NC	52	PERST0#		

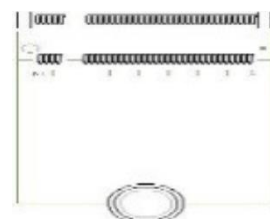

DC_IN1: DC Power Input Connector (+9~48V)

Connector Type: Terminal Block 1x3 3-pin, 5.0mm pitch

Pin	Definition
1	+9~48VIN
2	Ignition (IGN)
3	GND

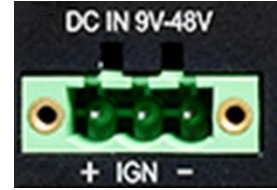

CAUTION

Please disconnect the power source before mounting the DC power cables or connecting the DC power connector to system.

PWR_SW2: Power On/Off Switch Connector

Pin	Definition
1	PWR_SW
2	GND



WARNING

Do not apply power to this connector!
This port is used to connect a SWITCH!

CN1 / CN2: LAN1 / 2 LED Status Definition

Act LED Status	Definition
Blinking Yellow	Data Activity
Off	No Activity

Link LED Status	Definition
Steady Green	1Gbps Network Link
Steady Orange	100Mbps Network Link
Off	10Mbps Network Link

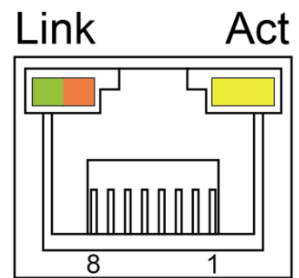

FAN1: External PWM Fan Connector

Connector Type: Terminal Block 1X4 3-pin, 3.5mm pitch

Pin	Definition
1	GND
2	+12V
3	SENSE
4	Control



COM1 / COM2 / COM3 / COM4: RS232 / RS422 / RS485 Connector

Connector Type: 9-pin D-Sub

Pin	RS232 Definition	RS422 / 485 Full Duplex Definition	RS485 Half Duplex Definition
1	DCD	TX-	DATA -
2	RXD	TX+	DATA +
3	TXD	RX+	
4	DTR	RX-	
5	GND		
6	DSR		
7	RTS		
8	CTS		
9	RI		

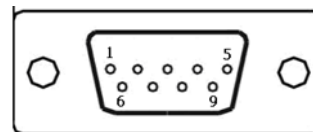

POWER1 / 2 / 3 / 4: Power Connector

Connector Type: 1x4 4-pin Wafer, 2.0mm pitch

Pin	Definition
1	+5V
2	GND
3	GND
4	+12V

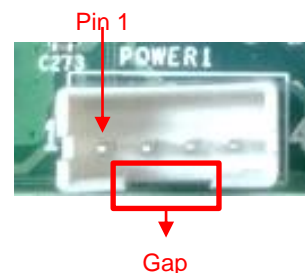

LED_B1: PWR / HDD / IGN / TEMP LED Status

LED B1	Status	LED Color
Power LED	Power ON	Green
	Standby	Blinking Green and Blue
HDD LED	HDD Read/Write	Blinking Yellow
IGN LED	IGN Disabled	Colorless
	IGN Enabled	Blue
	ACC ON	Green
TEMP LED	System Temp ≤ 65°C	Colorless
	65°C < System Temp ≤ 70°C	Blue
	70°C < System Temp ≤ 75°C	Red
	75°C < System Temp	Blinking Red

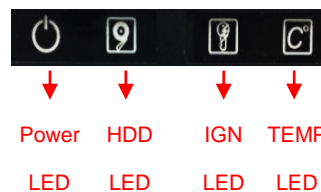

NOTE

The TEMP LED is only available when IGN module is installed.



Chapter 3

System Setup

3.1 Removing the Top Cover



WARNING

In order to prevent electric shock or system damage, before removing the chassis cover, must turn off power and disconnect the unit from power source.

1. Turn over the unit to have the bottom side face up, loosen the 6 screws on the bottom cover and place them aside for later use.

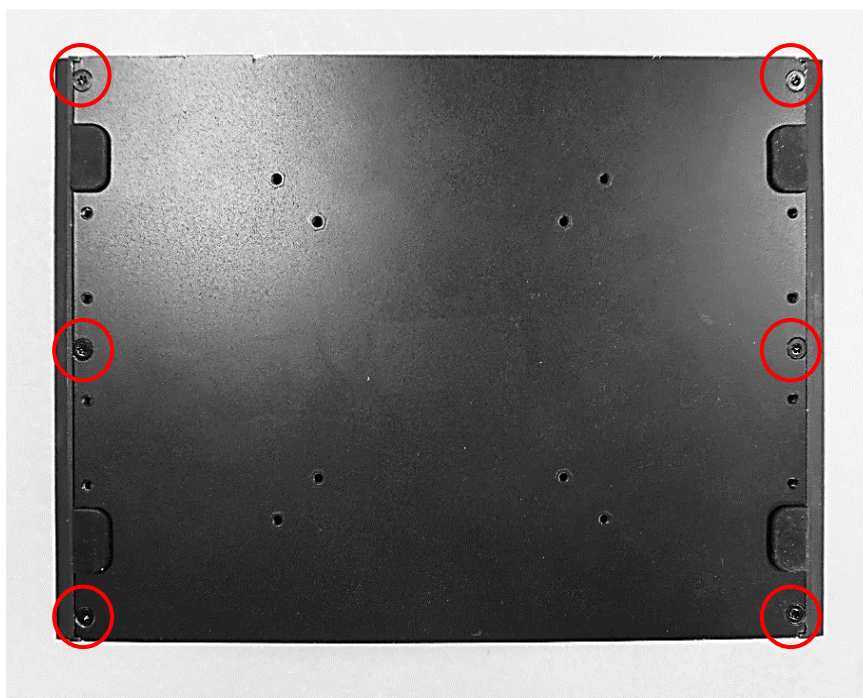

2. Remove the bottom cover from the chassis.



3. Loosen the 4 screws. Pull out 4 latches as marked on photo.

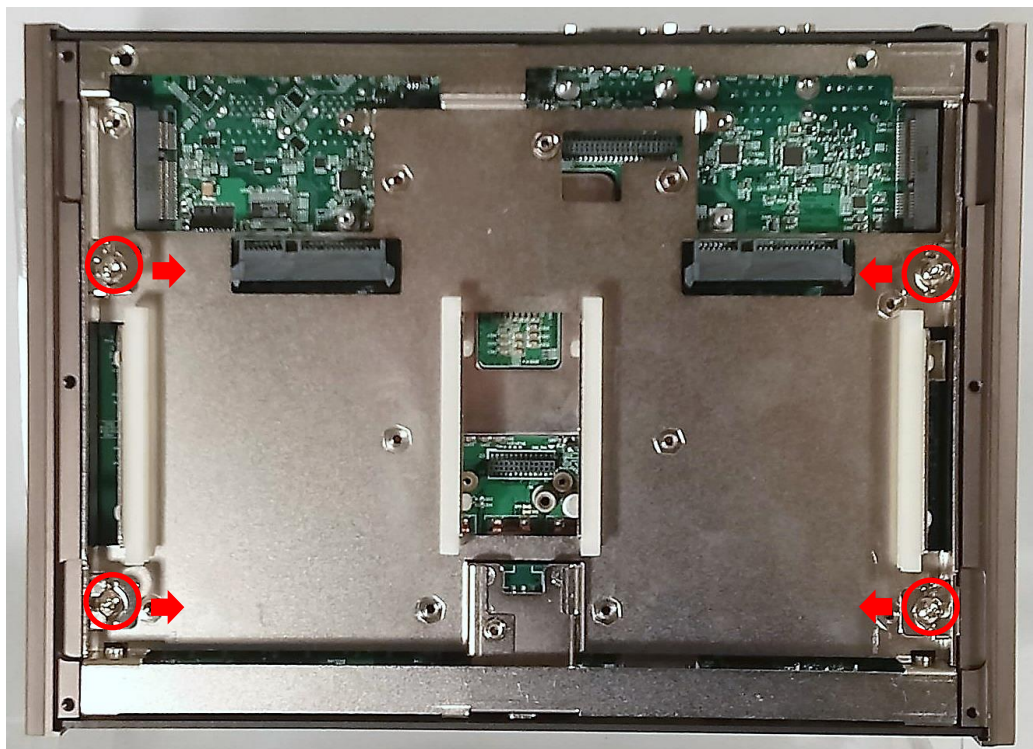

4. Hold front and rear panel and lift up the body of unit vertically.



5. Turn over the body of the unit and place it gently.

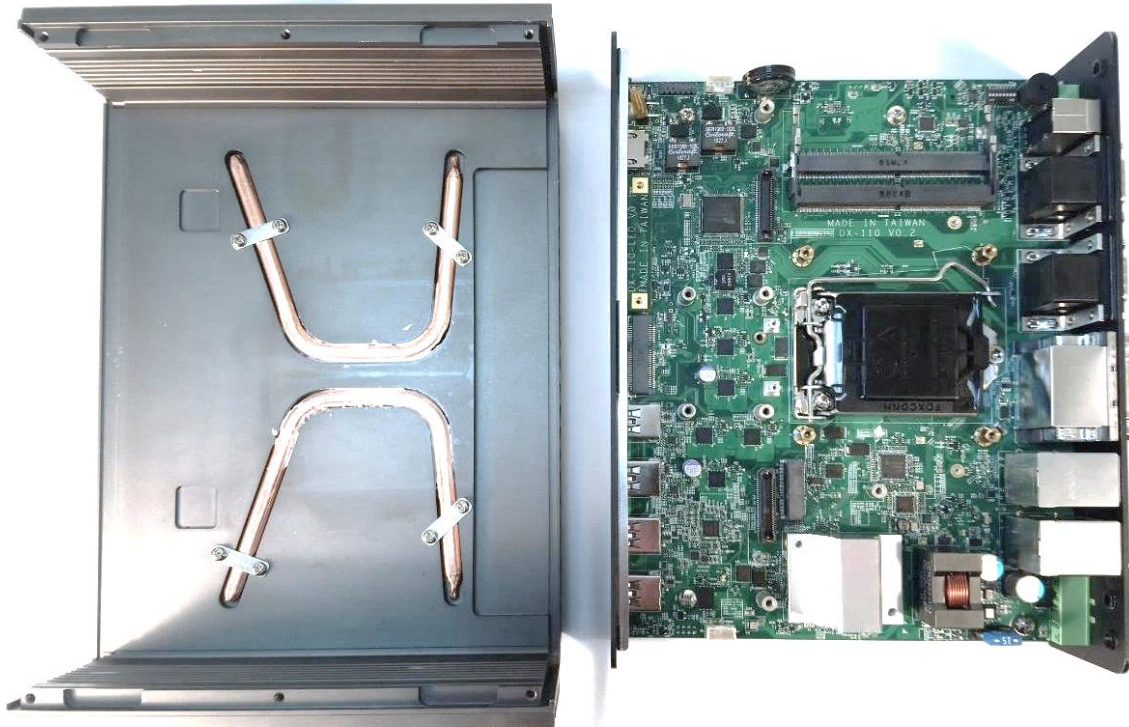

3.2 Installing the CPU

1. Locate the CPU socket, remove the protection cover on it.



2. Press the CPU socket lever and pull it aside away from the socket to unlock it. Pull back the lever to open the socket.

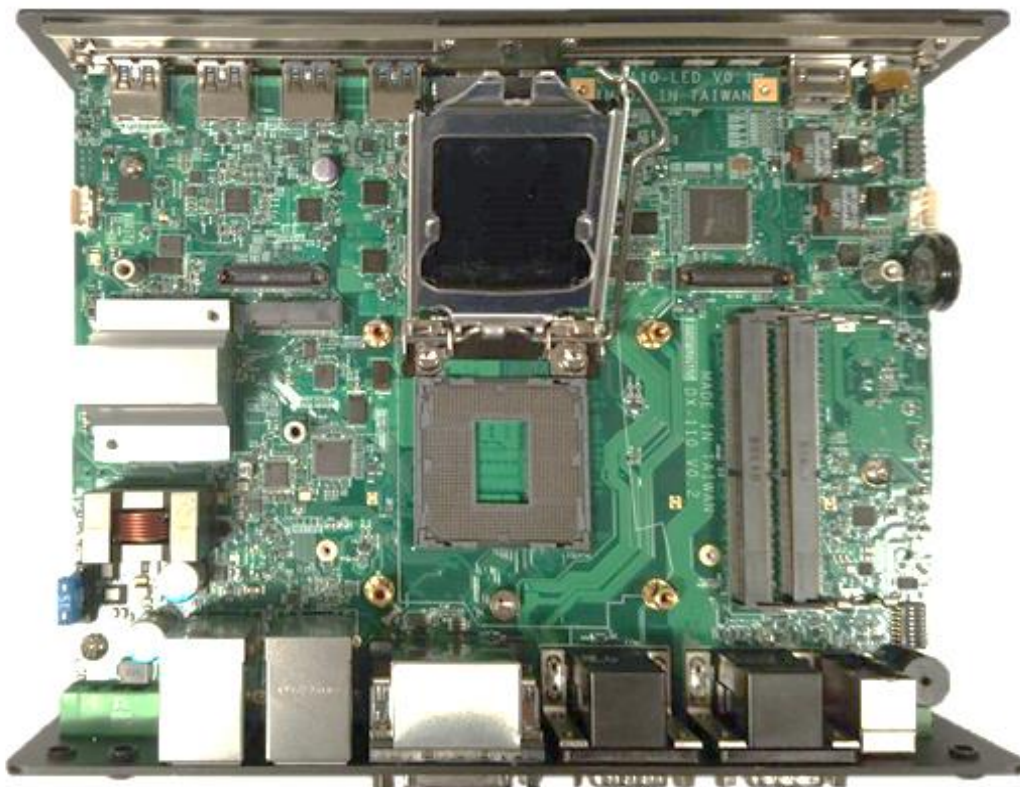

3. Align the notches on CPU with the alignment post on socket.

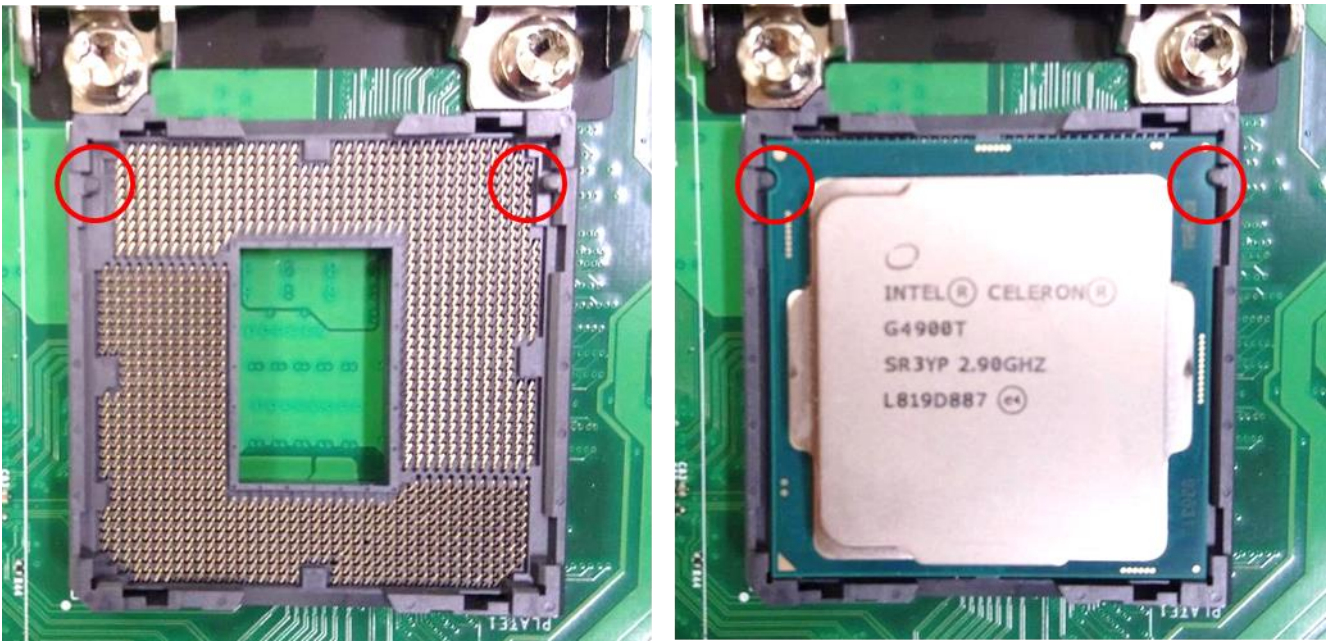

4. The notches of socket provide the space for fingers while lowering the CPU, hold the CPU by the edges toward the notches and insert the CPU gently.



- Place the thermal pad on the CPU heat spreader. Press down the socket lever to lock the CPU.

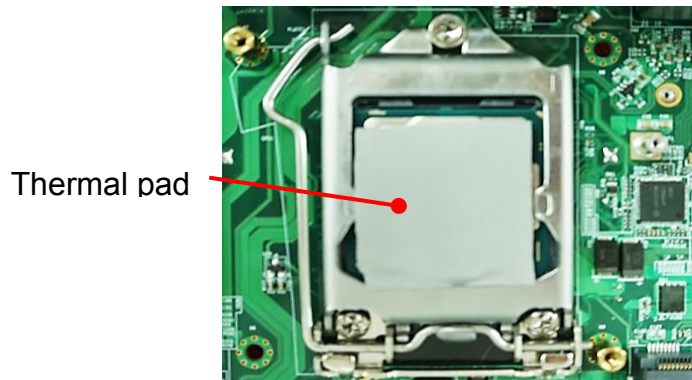

CAUTION

Before putting on the thermal block (in the next step), please make sure the protective film on the Thermal Pad has been removed!

- Confirm the installation direction of the CPU heatsink and align mounting holes of heatsink with the four nut studs.

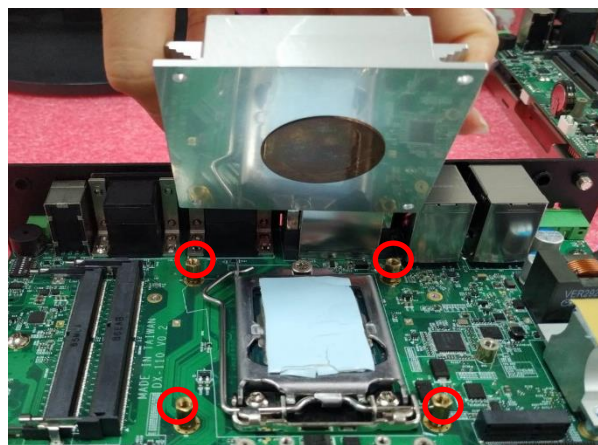

- Flip the corner of thermal pad and fasten the heatsink with provided 4 screws.

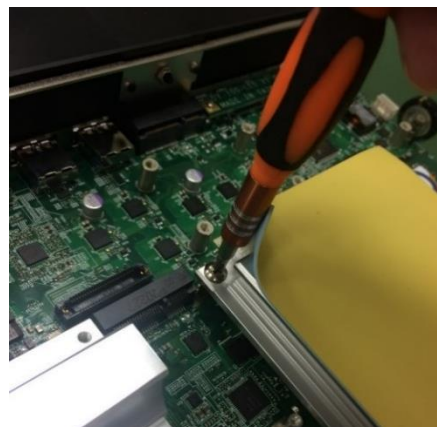
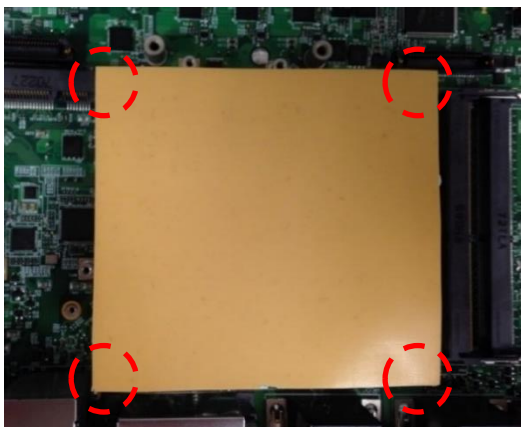

CAUTION

The yellow surface is part of the thermal pad. Do not tear it off as it would affect the thermal conductivity.

3.3 Installing SO-DIMM Memory

1. Locate the SODIMM socket on the top side of system.

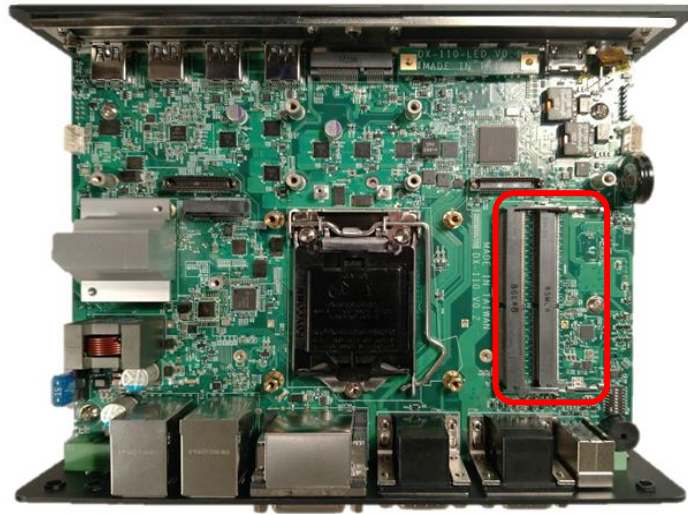

2. Insert a SO-DIMM at a 45-degree angle until its edge connector is connected to SO-DIMM socket firmly.



Lower socket



Upper socket

3. Press down the module until the retaining clips snap back in place.

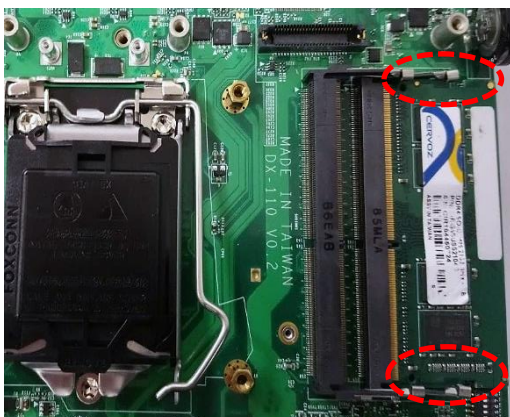

Lower socket



Upper socket

3.4 Installing a Mini-PCIe/mSATA Card

1. Locate the Mini PCIe socket on the top side of system.

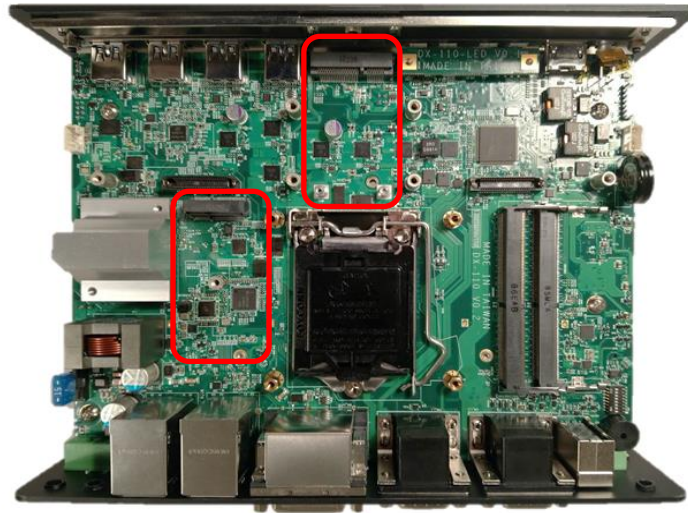

2. Insert the Mini-PCIe card at a 45-degree angle until its edge connector is connected firmly into slot. For 3G/4G Mini-PCIe card, please install onto CN3 slot.

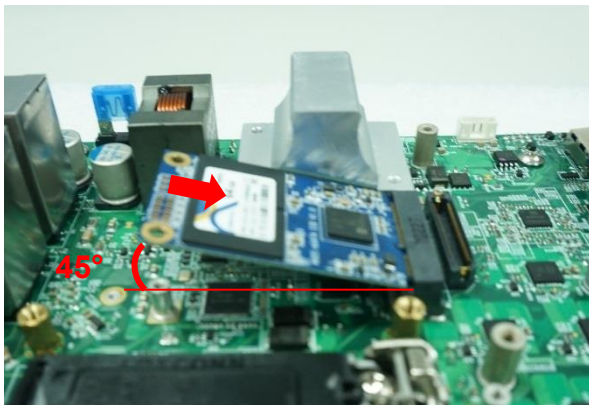

CN3,4,6 slot

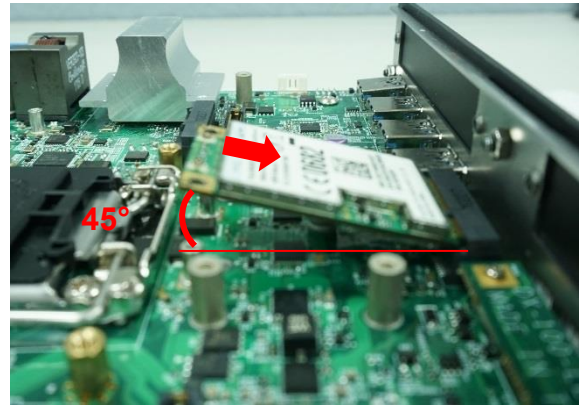

CN3 slot

3. Press the card down and secure it with 2 screws.



3.5 Installing Antennas

1. Remove the antenna rubber covers on rear panel.



2. For antenna 1 and antenna 2, please penetrate the antenna jack through the hole at both sides as illustrated.

For antenna 3, please pull off the rear panel by loosening the 10 D-Sub jack screws on rear panel firstly, and penetrate the antenna jack through the hole at both sides as illustrated.



- For antenna 1 and antenna 2, put on washer and fasten the nut with antenna jack.
For antenna 3, put on rear panel back and fasten 10 D-Sub jack screws on it, and then put on washer and fasten the nut with antenna jack.



- Assemble the antenna and antenna jack together.

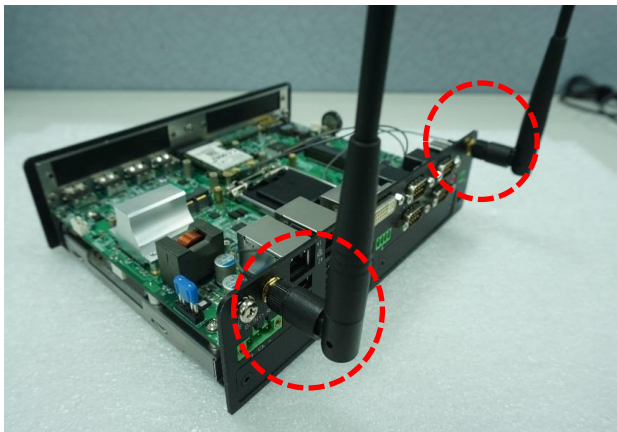

- Attach the RF connector at another end of cable onto the module.



3.6 Installing Thermal Pad

Note: The DX-1100 series don't need to additional installation of the PCH thermal pad.

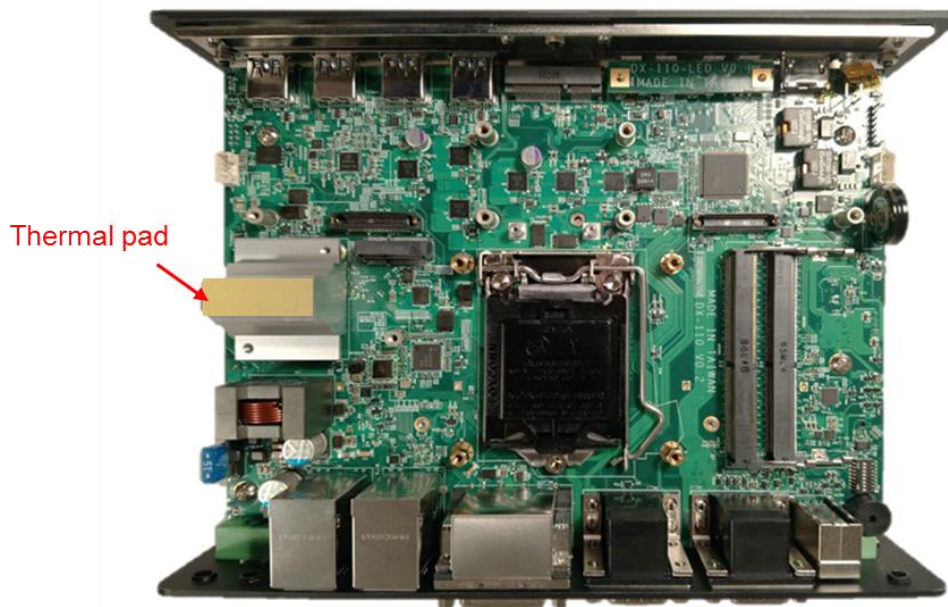

CAUTION

The yellow surface is part of the thermal pad. Do not tear it off as it would affect the thermal conductivity.

3.7 Installing Top Cover

1. Hold front and rear panel and put the body of unit back to chassis and fasten the 4 screws as marked on photo.

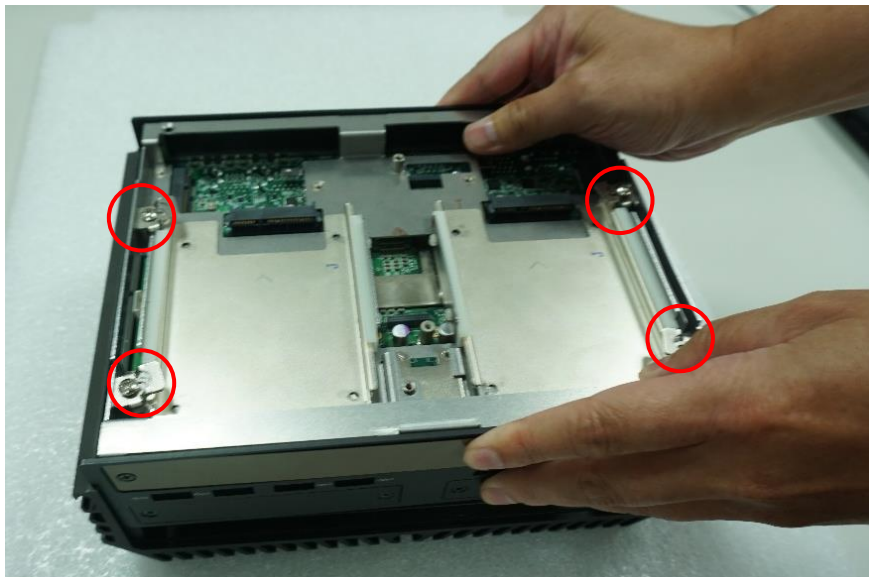

3.8 Installing Bottom Cover

1. Place the bottom cover back to system.



2. Fasten the bottom cover with 6 screws.

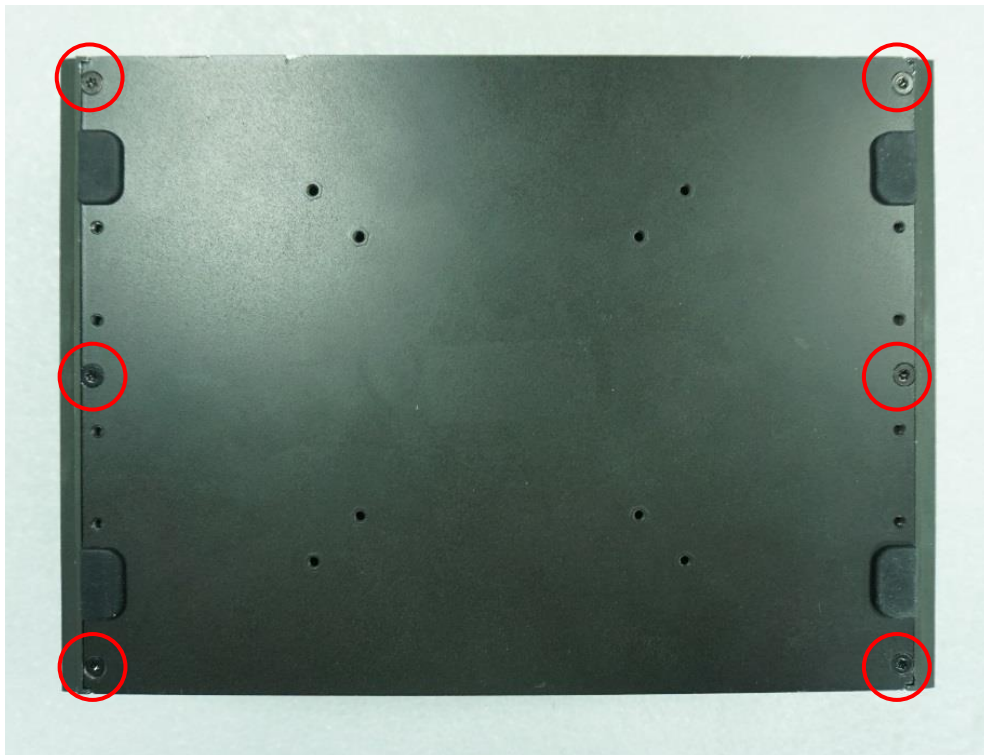

3.9 Removing the Front Cover Plate

1. Loosen 2 screws on front panel to remove cover plate.



Notes

NOTE

It's advised to fasten the 2 screws manually. If fastened with an electrical screw driver, please set the torque of the driver to 2.5KgF.



3.10 Installing a SATA Hard Drive at Front Side

1. Locate the removable HDD bay and loosen the screw.



2. Pull the rotating arm and pull the HDD bracket out of system.



3. Make the bottom side of the HDD face up, place the HDD bracket on it. Ensure the direction of bracket is correct and use 4 provided screws to assemble HDD and HDD bracket together.

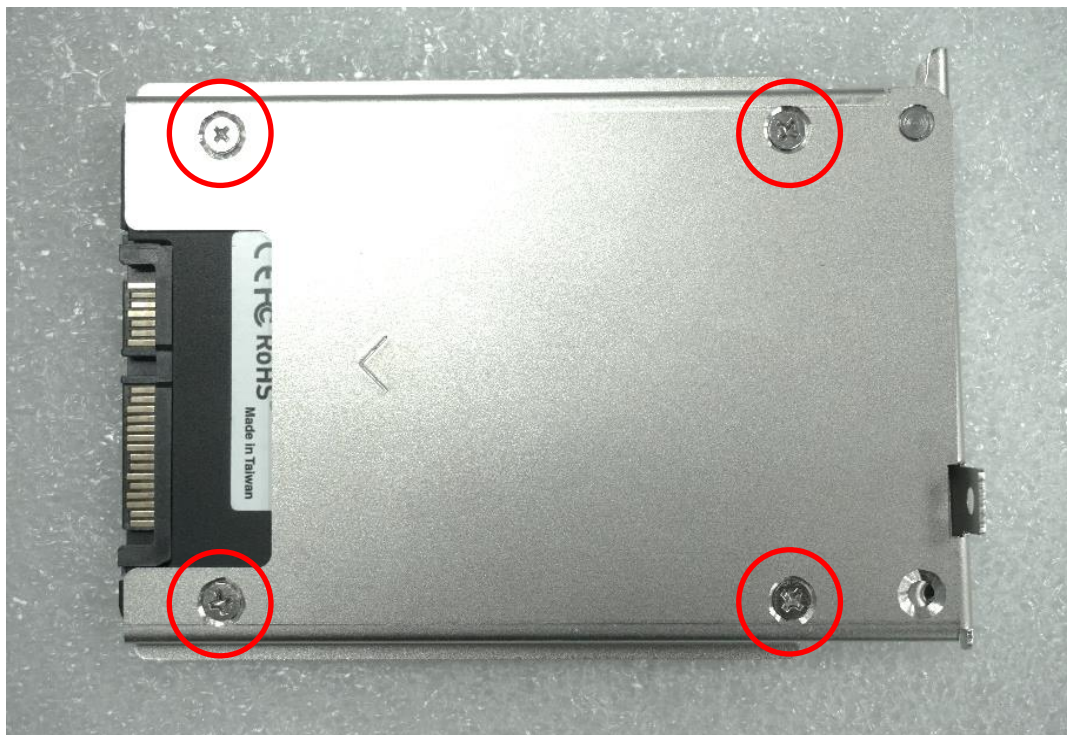

4. Align the HDD bracket assembly with the entrance of removable HDD bay. Holding the rotating arm and insert the HDD bracket until the connector of HDD contact the SATA connector firmly.



5. Place the rotating arm back and fasten the screw.



3.11 Installing a SIM Card

1. Locate the SIM card slot at front side.

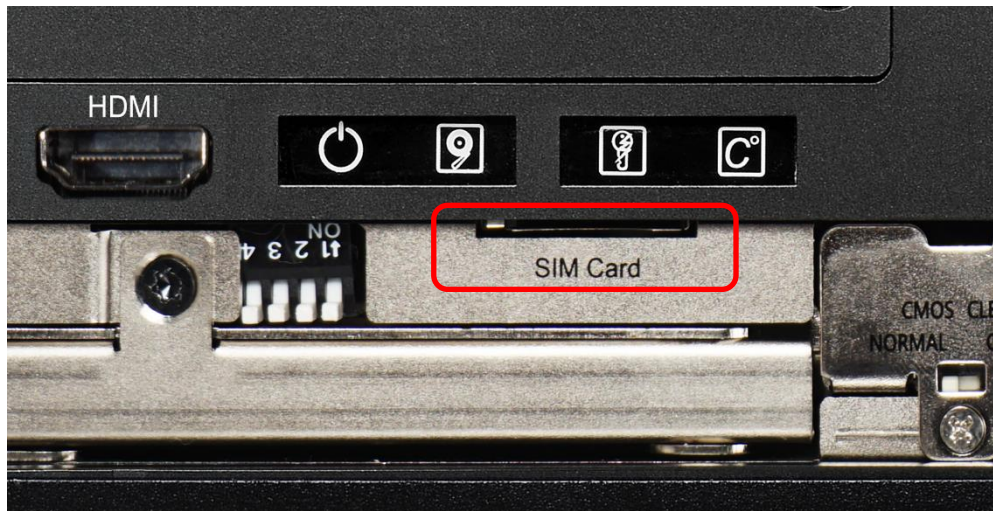

2. Insert a SIM card into SIM slot with the gold contacts facing up. Please pay attention to the insert orientation as illustrated.



3.12 Installing the CMOS Battery

1. Locate the removable CMOS Battery and loosen the screw.



2. Pull out the CMOS battery bracket with assistance of a tweezer.



3. Insert a CMOS battery in the battery slot.

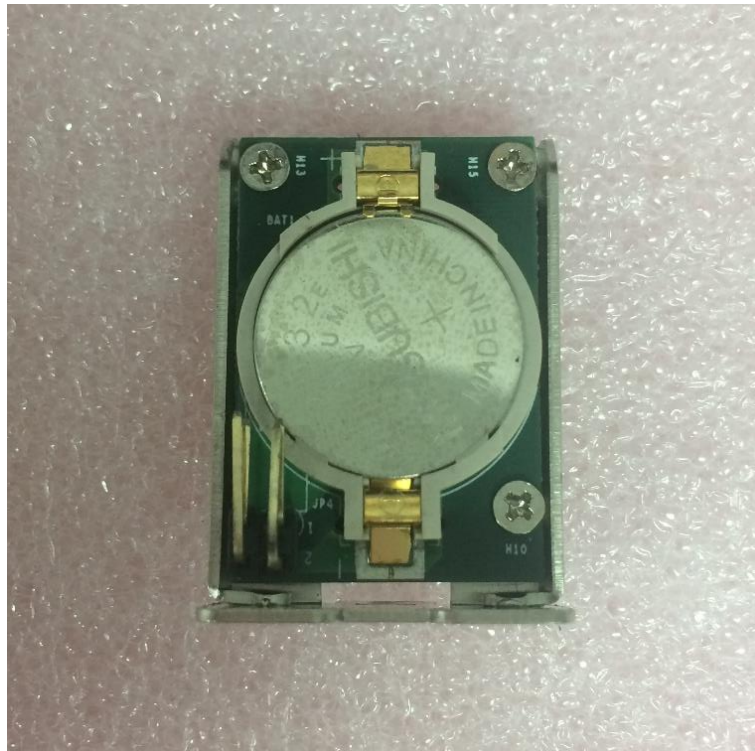

4. Insert the battery bracket firmly and fasten the screw.



3.13 Fastening the Cover

1. Fasten the cover by using the two screws.



3.14 Installing an External Fan

1. Prepare an external fan. Loosen the 2 screws halfway on mounting frame before attempting to install it.

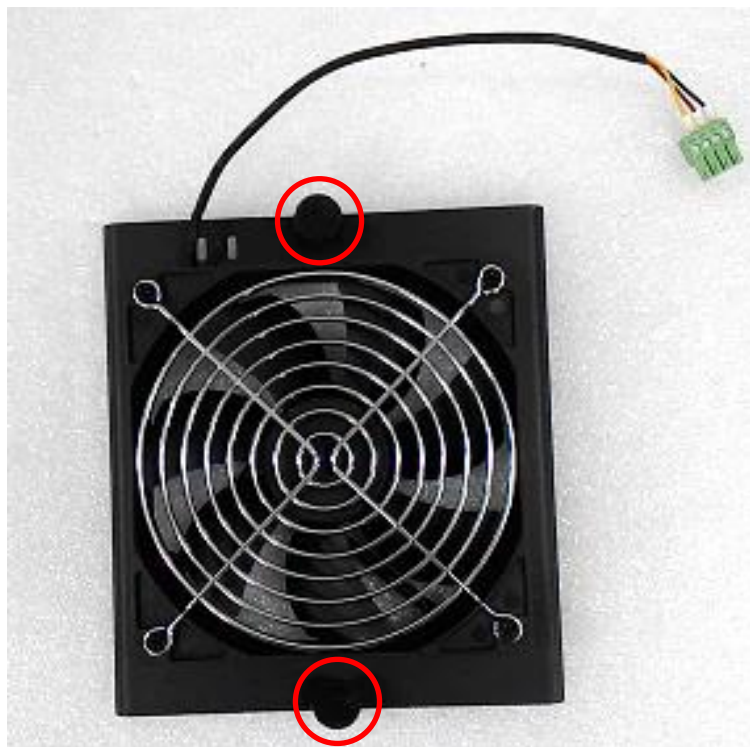

- Slide the FAN into the middle groove of chassis as illustrated. Tighten the 2 screws to fix it onto chassis.

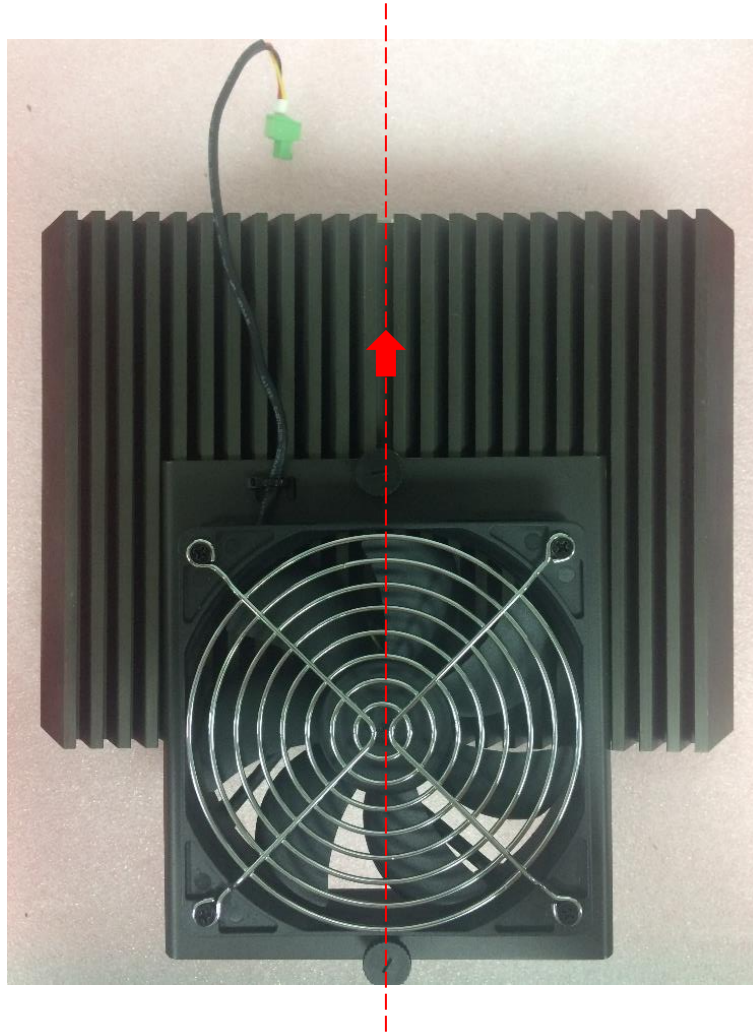

- Move the fan to the center of chassis. Tighten the 2 screws marked on photo to secure it.

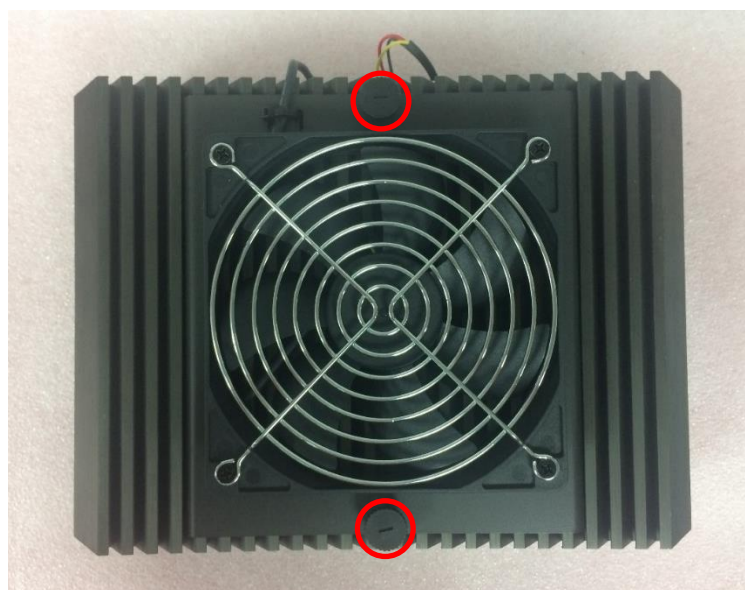

4. Connect the FAN cable to external fan power connector at rear panel.



3.15 Wall Mount Brackets

DX-1100 series offers wall mount brackets that customers can install system on the wall in convenient and economical ways.

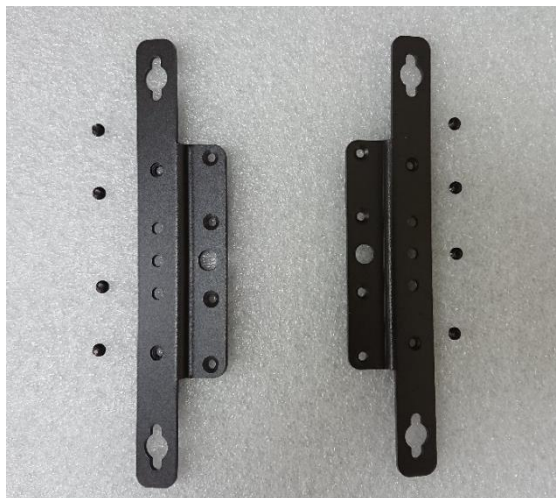

1. The mounting holes are at the bottom side of system. Use provided 8 screws to fasten the bracket on each side.

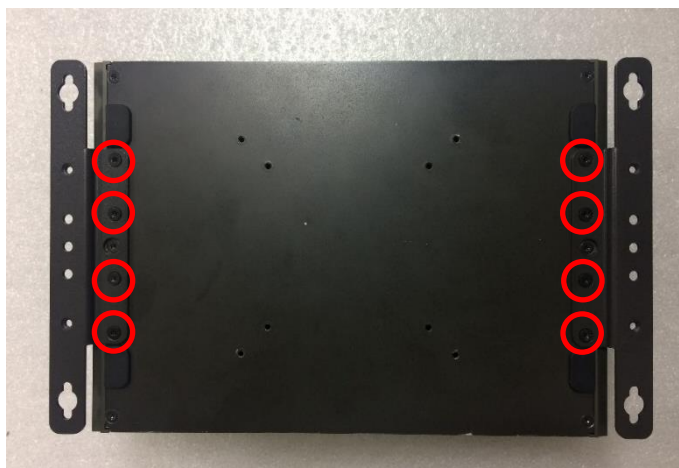

2. There are 2 bracket mounting holes at left and right side for customer fix the system on the wall.

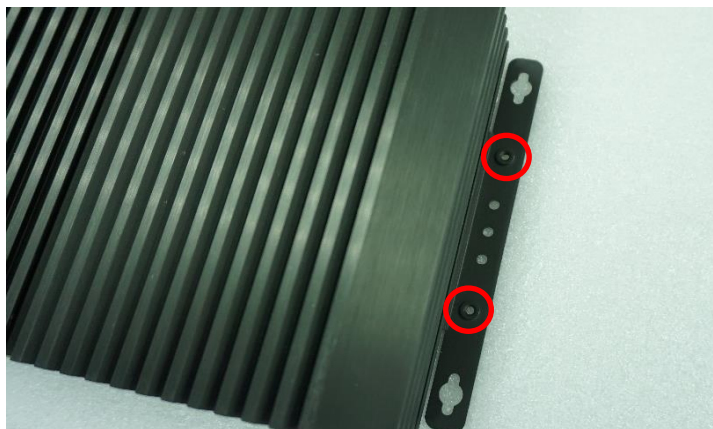

3.16 DIN-Rail Mount Brackets

DX-1100 series offers DIN-Rail Mount that customer can install system on the DIN Rail.

1. Please refer to section 3.15 Wall Mount Brackets to install mounting bracket at both sides of system.

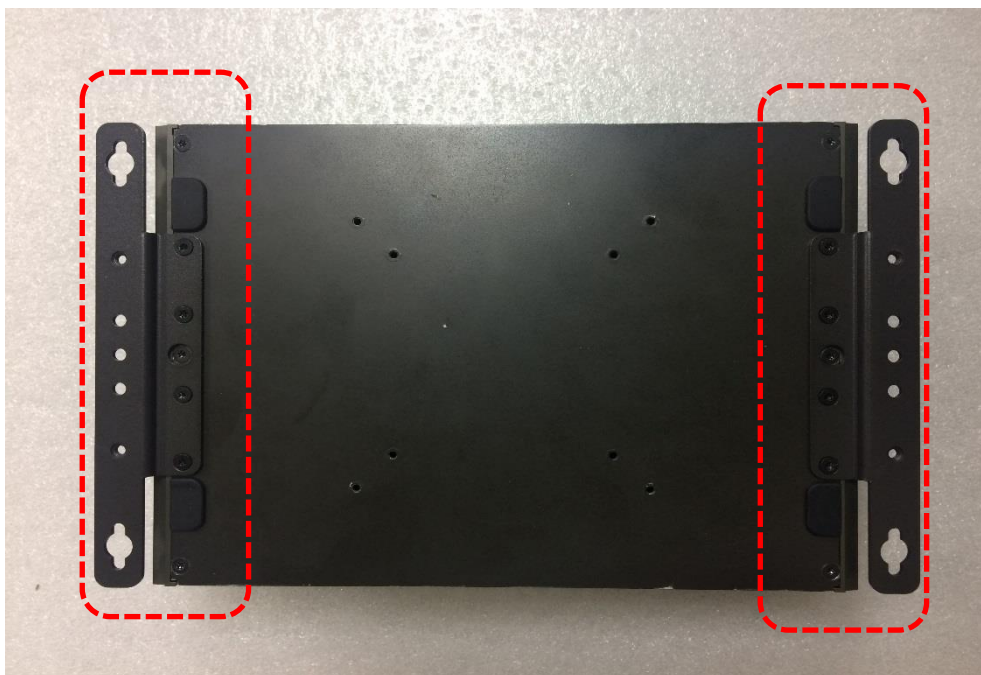

2. Fasten 2 DIN rail mounting clips to mounting brackets on both sides with provided 4 screws as illustrated.



3. Clip the system into DIN rail as illustrated by the following steps. (1) Have lower end of mounting clip snaps into the DIN rail. (2) Press the system toward to have upper end of mounting clip snaps into the other side of DIN rail.

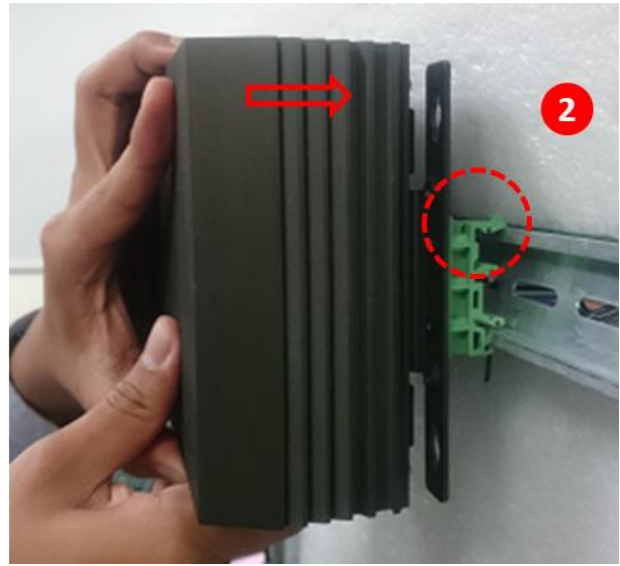

3.17 VESA Mount

DX-1100 series supports VESA mounting that customer can mount system with panel complying with VESA 75mm and 100 mm standard for various usage. The 75mm VESA uses blue-circle-marked screw holes. The 100mm VESA uses red-circle-marked screw holes.

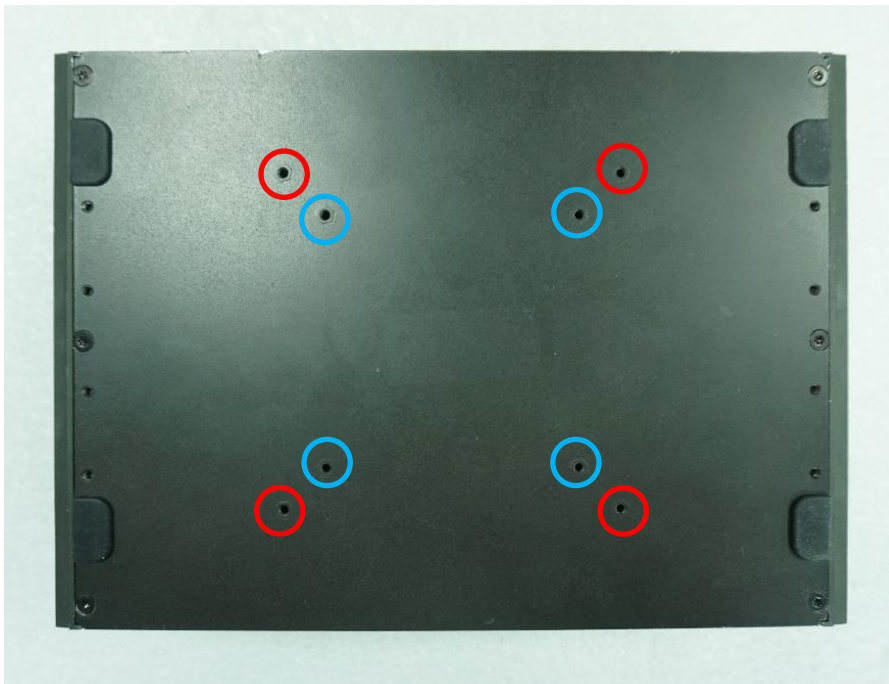

1. The following picture illustrates the installation of DX-1100 series on a VESA stand. Align the 4 screw holes of VESA stand with the screw holes on bottom side of system. Fasten 4 screws to fix it.

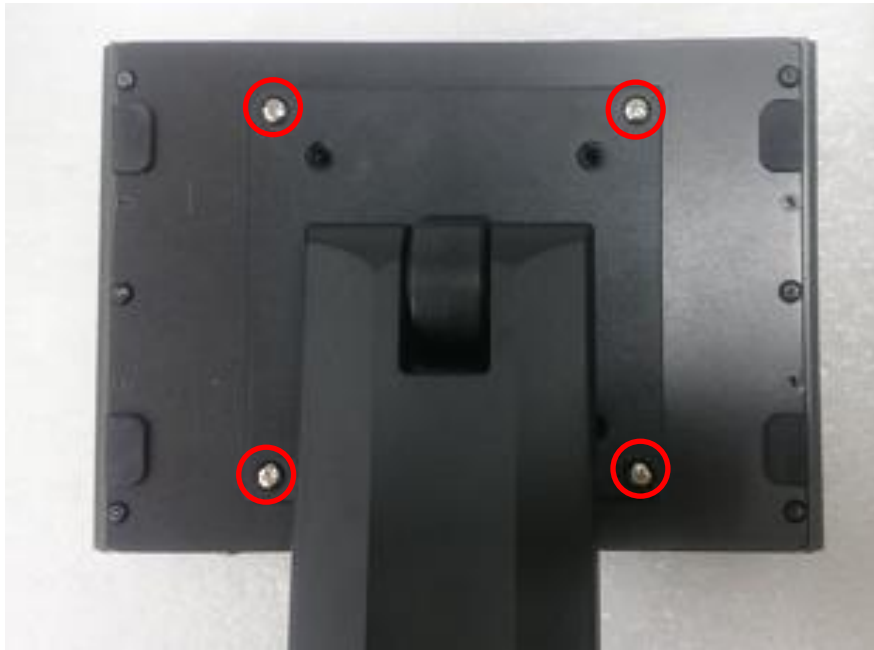

2. Provided below is mounted with VESA stand.



3.18 Side Mount Brackets

DX-1100 series offers Side Mount that customer can install system to the right or left side of wall to create effective of space.

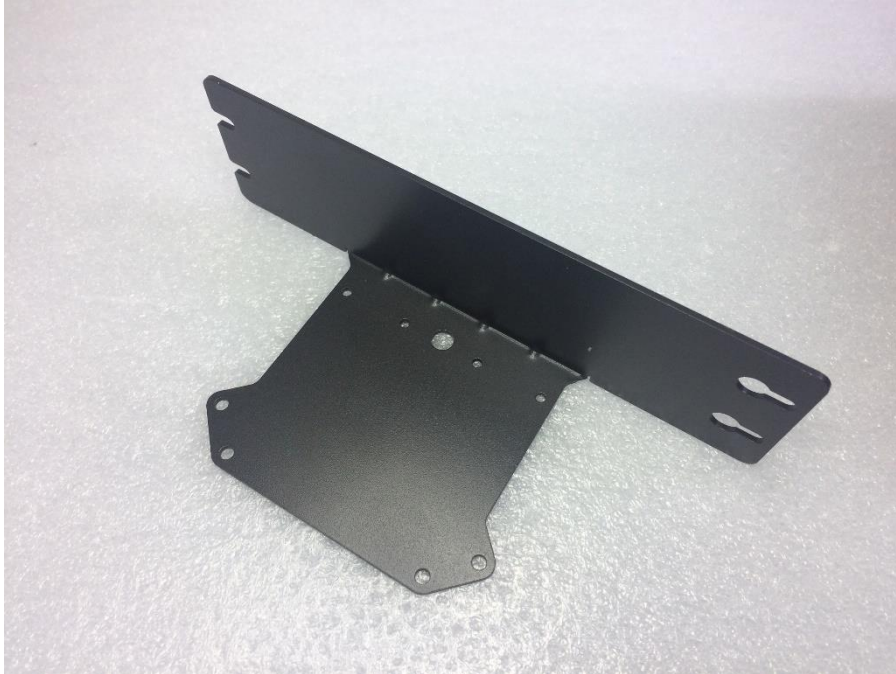

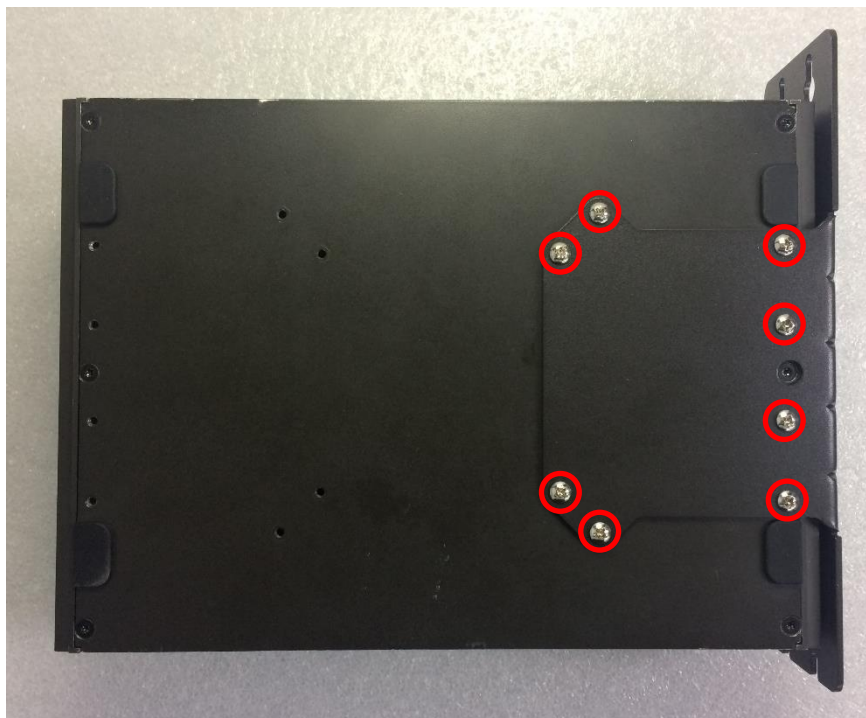

1. The mounting holes are at the bottom of system. Fasten the 8 screws to fix the side mount bracket with system together.



2. Fasten the screws through the bracket mounting hole to mount system on the wall.





Chapter 4

BIOS Setup

4.1 BIOS Introduction

The BIOS (Basic Input/ Output System) is a program located on a Flash Memory on the motherboard. When you start the computer, the BIOS program will gain control. The BIOS first operates an auto-diagnostic test called POST (power on self-test) for all the necessary hardware, it detects the entire hardware device and configures the parameters of the hardware synchronization.

BIOS Setup

Power on the computer and by pressing immediately allows you to enter Setup. If the message disappears before your respond and you still wish to enter Setup, restart the system to try again by turning it OFF then ON or pressing <Ctrl>, <Alt> and <Delete> keys.

Control Keys	
<←> <→>	Move to select screen
<↑> <↓>	Move to select item
<Esc>	Quit the BIOS Setup
<Enter>	Select item
<Page Up/+>	Increases the numeric value or makes changes
<Page Down/->	Decreases the numeric value or makes changes
<Tab>	Select setup fields
<F1>	General help
<F2>	Previous value
<F3>	Load Optimized defaults
<F10>	Save configuration and Exit

Main Menu

The main menu lists the setup functions you can make changes to. You can use the arrow keys (↑↓) to select the item. The on-line description of the highlighted setup function is displayed at the bottom of the screen.

Sub-Menu

If you find a right pointer symbol appears to the left of certain fields that means a sub-menu can be launched from this field. A sub-menu contains additional options for a field parameter. You can use arrow keys (↑↓) to highlight the field and press <Enter> to call up the sub-menu. Then you can use the control keys to enter values and move from field to field within a sub-menu. If you want to return to the main menu, just press the <Esc >.

4.2 Main Setup

Press to enter BIOS CMOS Setup Utility, the Main Menu (as shown below) will appear on the screen. Use arrow keys to move among the items and press <Enter> to accept or enter a sub-menu.

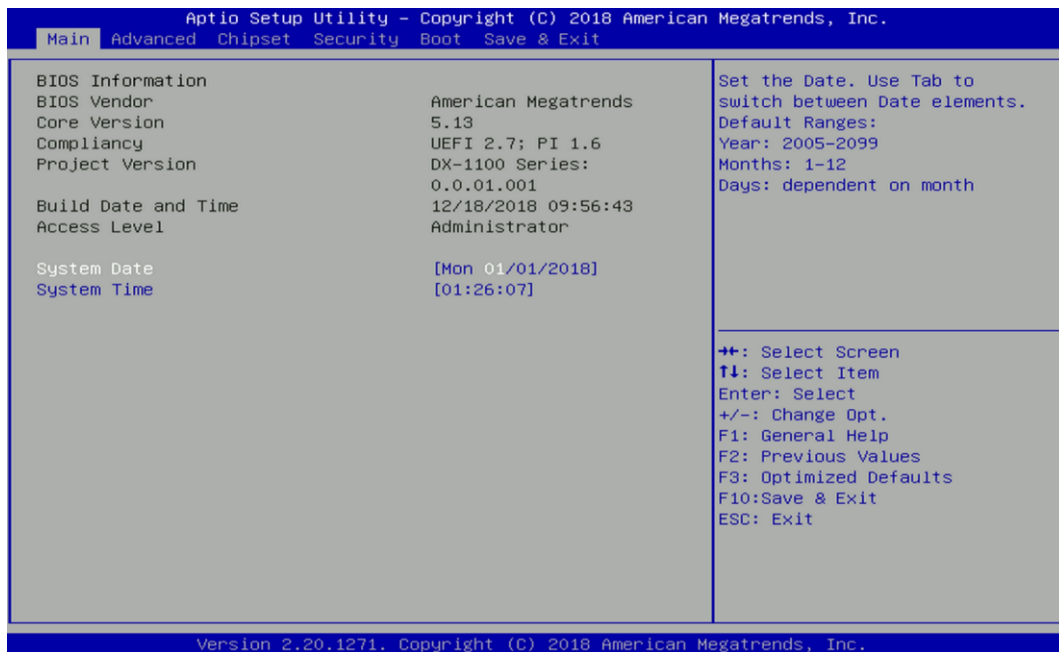

4.2.1 System Date

Set the date. Please use <Tab> to switch between date elements.

4.2.2 System Time

Set the time. Please use <Tab> to switch between time elements.

4.3 Advanced Setup

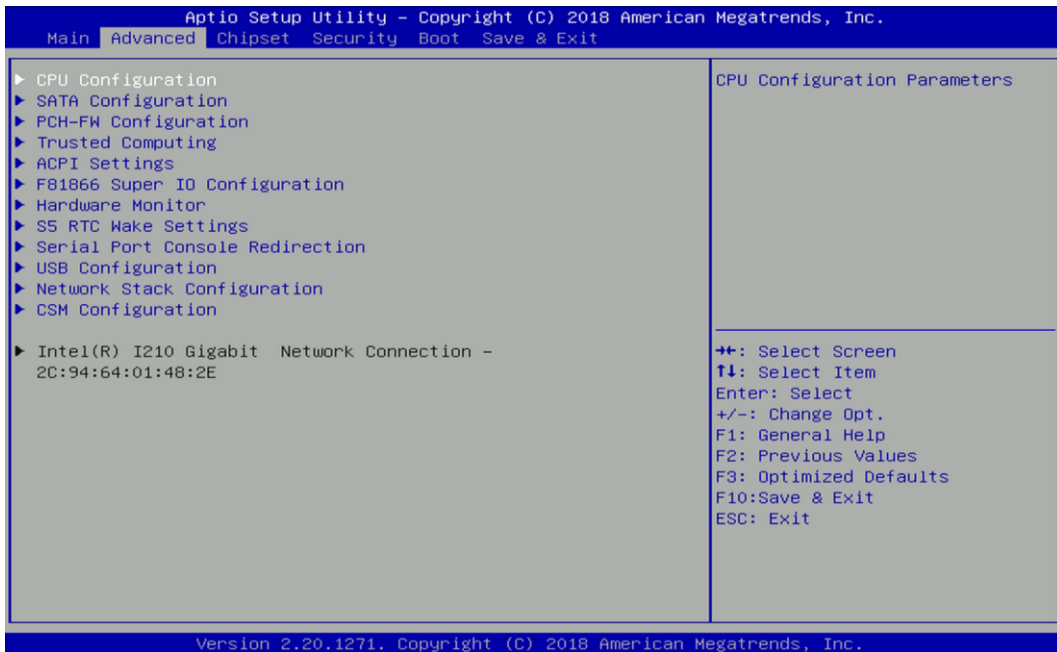

4.3.1 CPU Configuration

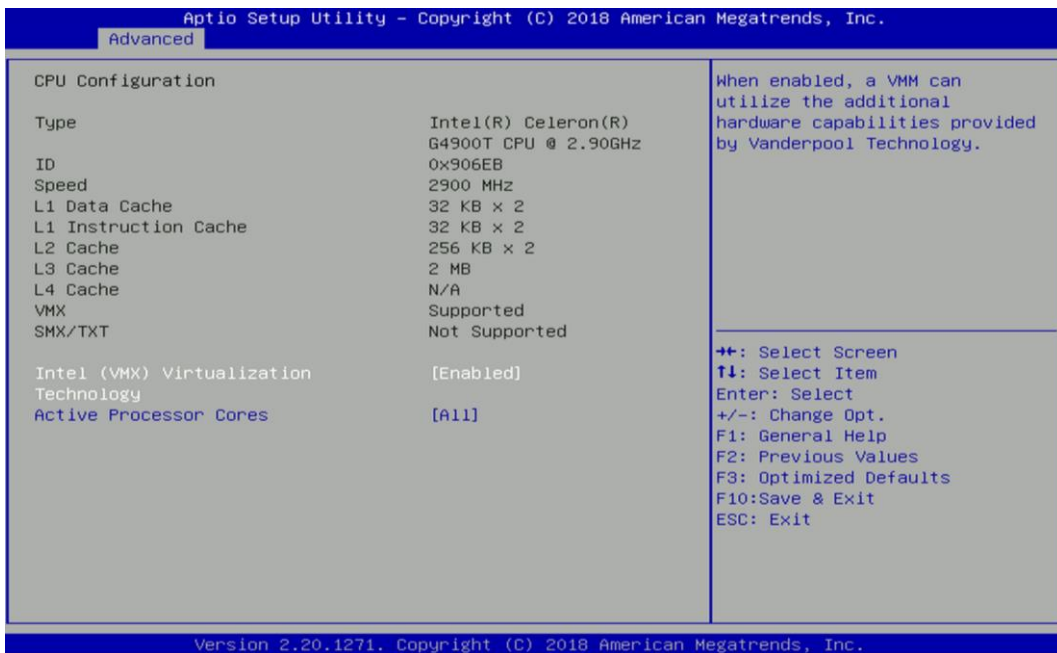

■ Intel® (VMX) Virtualization Technology

Enables or disables Intel® Virtualization Technology, which will allow a platform to run multiple operating systems and applications in independent partitions. With virtualization, one computer system can function as multiple virtual systems.

■ Active Process Cores

Allows you to choose the number of active processor cores.

Configuration options: [All] [1].

4.3.2 SATA And RST Configuration

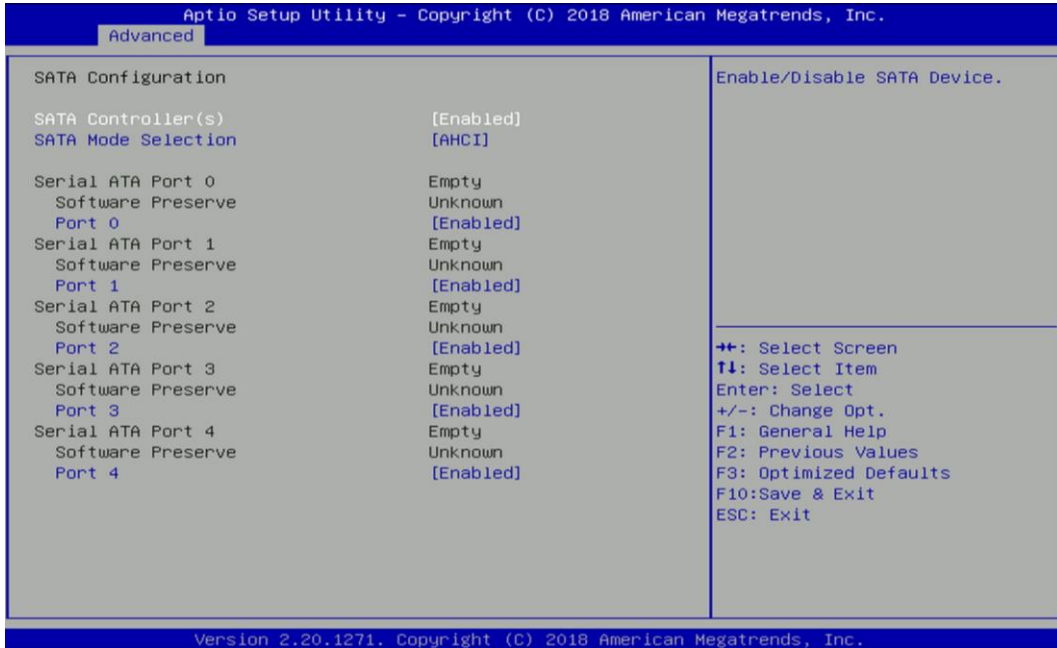

■ SATA Controller(s) [Enabled]

Enables or disables SATA device.

■ SATA Mode Selection [AHCI]

Allows you to select which mode SATA controller will operate.

Configuration options: [AHCI], [RAID]

- Serial ATA Port 0**
Port 0 [Enabled]
Enables or disables SATA Port 0.
- Serial ATA Port 1**
Port 1 [Enabled]
Enables or disables SATA Port 1.
- Serial ATA Port 2**
Port 1 [Enabled]
Enables or disables SATA Port 2.
- Serial ATA Port 3**
Port 1 [Enabled]
Enables or disables SATA Port 3.
- Serial ATA Port 4**
Port 1 [Enabled]
Enables or disables SATA Port 4.

- ❑ **Serial ATA Port 5**
Port 1 [Enabled]
Enables or disables SATA Port 5.

4.3.3 PCH-FW Configuration

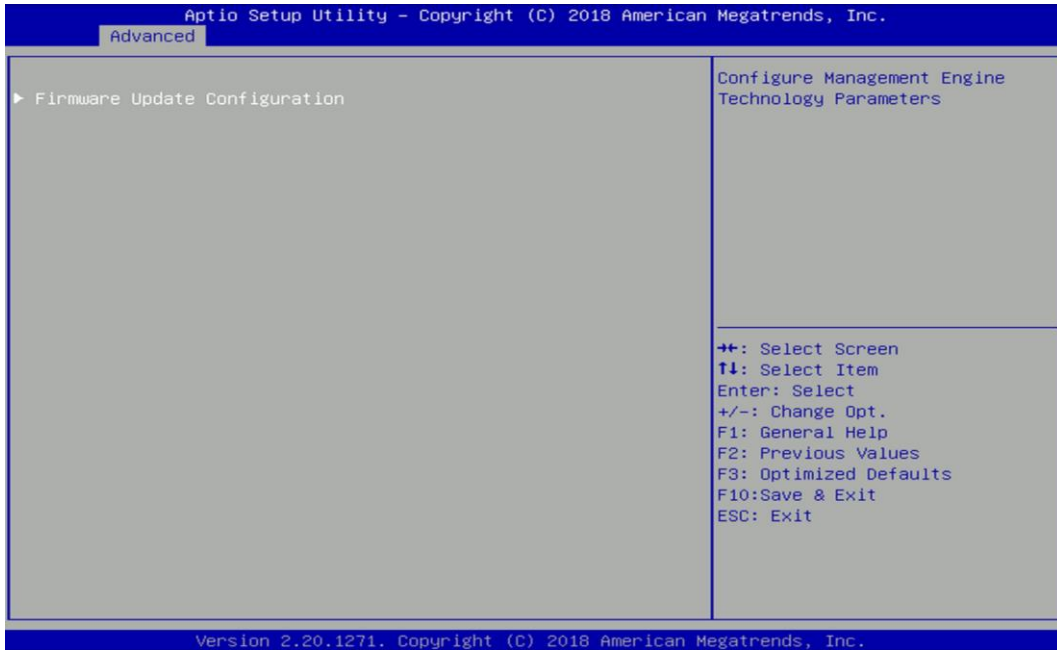

■ Firmware Update Configuration

Configure Management Engine Parameters

- ❑ **Me FW Image Re-Flash**
Enables or disables ME firmware Image Re-Flash function.

4.3.4 Trusted Computing Settings

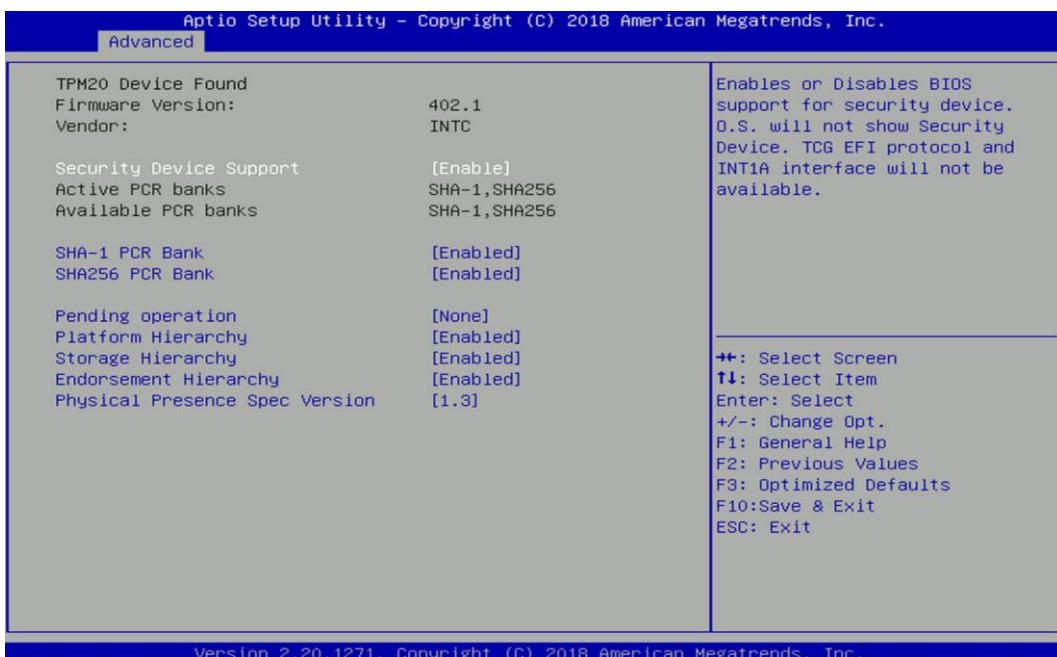

■ **Security Device Support [Enabled]**

Enables or disables Security Device Support function.

■ **SHA-1 PCR Bank [Enabled]**

Enables or disables SHA-1 PCR Bank function.

■ **SHA256 PCR Bank [Enabled]**

Enables or disables SHA256 PCR Bank function.

■ **Pending Operation [None]**

Allows you to select which mode Pending Operation will operate.

Configuration options: [None], [TPM Clear]

■ **Platform Hierarchy [Enabled]**

Enables or disables Platform Hierarchy function.

■ **Storage Hierarchy [Enabled]**

Enables or disables Storage Hierarchy function.

■ **Endorsement Hierarchy [Enabled]**

Enables or disables Endorsement Hierarchy function.

■ **Physical Presence Spec Version [1.3]**

Allows you to select which mode Physical Presence Spec Version will operate.

Configuration options: [1.2], [1.3]

4.3.5 ACPI Settings

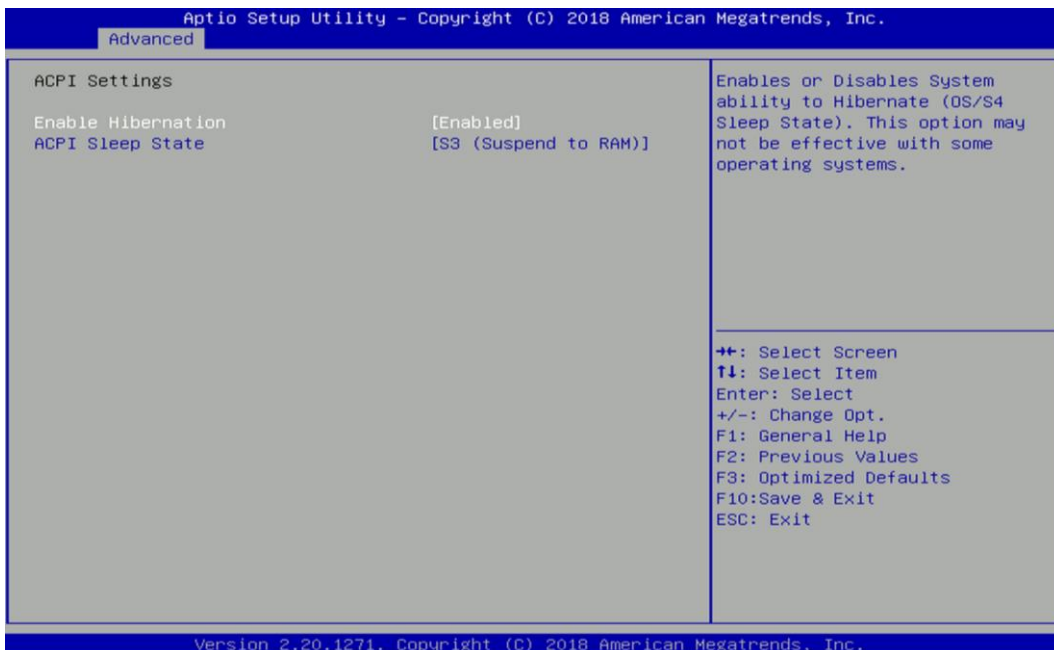

■ **Enable Hibernation [Enabled]**

Enables or disables system ability to hibernate state (OS/S4 state). This option may not be effective with some OS.

■ **ACPI Sleep State [S3 (Suspend to RAM)]**

Allows users to select the highest Advanced Configuration Power Interface® (ACPI) sleep state that system will enter when suspend button is pressed.

[Suspend Disabled]: Disables entering suspend state.

[S3 (suspend to RAM)]: Enables suspend to RAM state.

4.3.6 F81866 Super IO Configuration

Set Parameters of Serial Ports. User can Enable/Disable the serial port and Select an optimal setting for the Super IO Device.

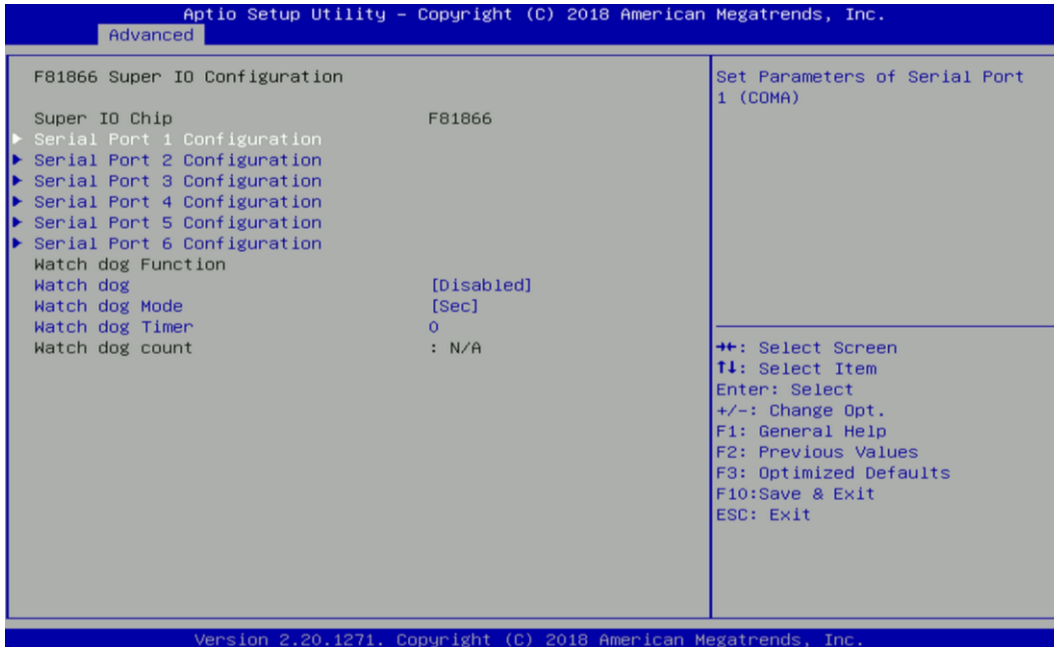

Serial Port 1~6 Configuration.

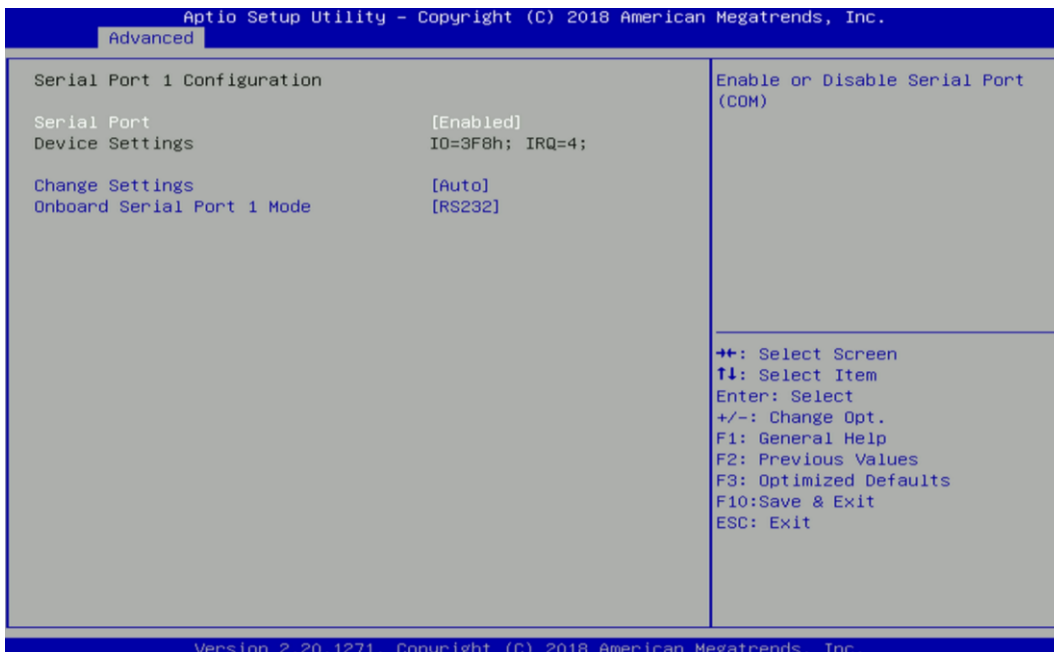

Serial Port [Enabled]

Enables or disables serial port.

Change Settings [Auto]

Allows you to change the IO Address & IRQ settings of the specified serial port.

Onboard Serial Port 1~6 Mode [RS232]

Allows you to select Serial Port Mode.

Configuration options: [RS232] [RS422/RS485 Full Duplex] [RS485 Half Duplex]

■ Watch Dog [Disabled]

Enables or disables watch dog function.

■ Watch Dog Mode [Sec]

Allows to set watchdog timer unit <Sec> or <Min>.

■ Watch Dog Timer [0]

Allows you to set watchdog timer's value in the range of 0 to 255.

4.3.7 Hardware Monitor

This screen displays the current status of all monitored hardware devices/components such as voltages, temperatures and all fans' speeds.



■ External Smart Fan Function [Enabled]

Enables or disables External Smart Fan function.

■ External Smart Fan Configuration [Enabled]

Configure External Smart Fan Parameters.

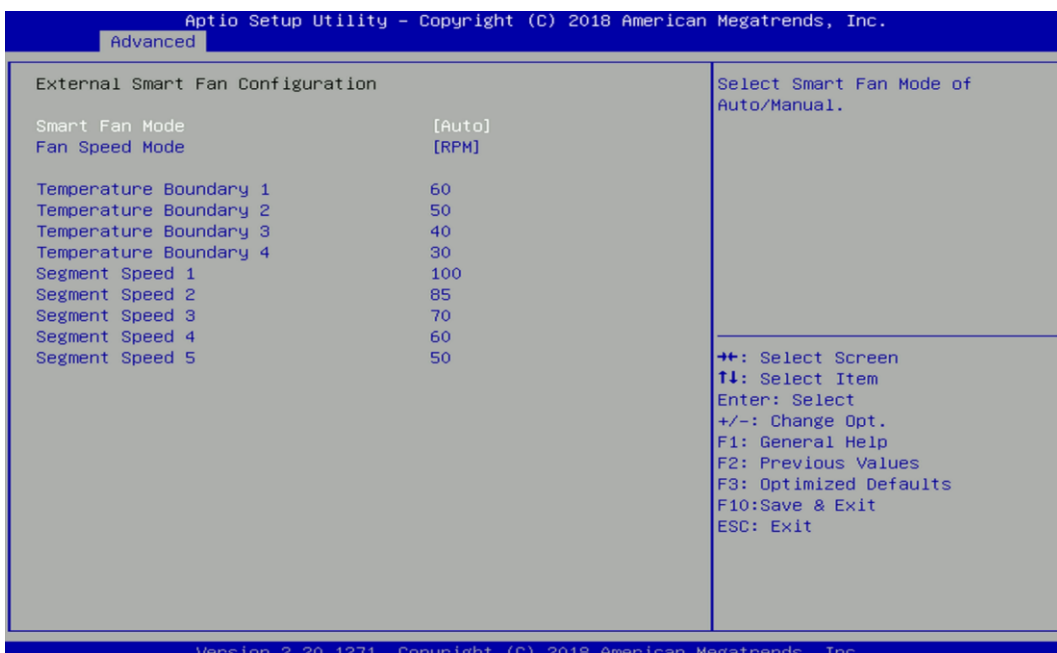

❑ **Smart Fan Mode [Auto]**

Allows you to select Smart Fan Mode.

Configuration options: [Auto] [Manual]

❑ **Fan Speed Mode [RPM]**

Allows you to select Fan Speed Mode.

Configuration options: [RPM] [Duty]

4.3.8 S5 RTC Wake Settings

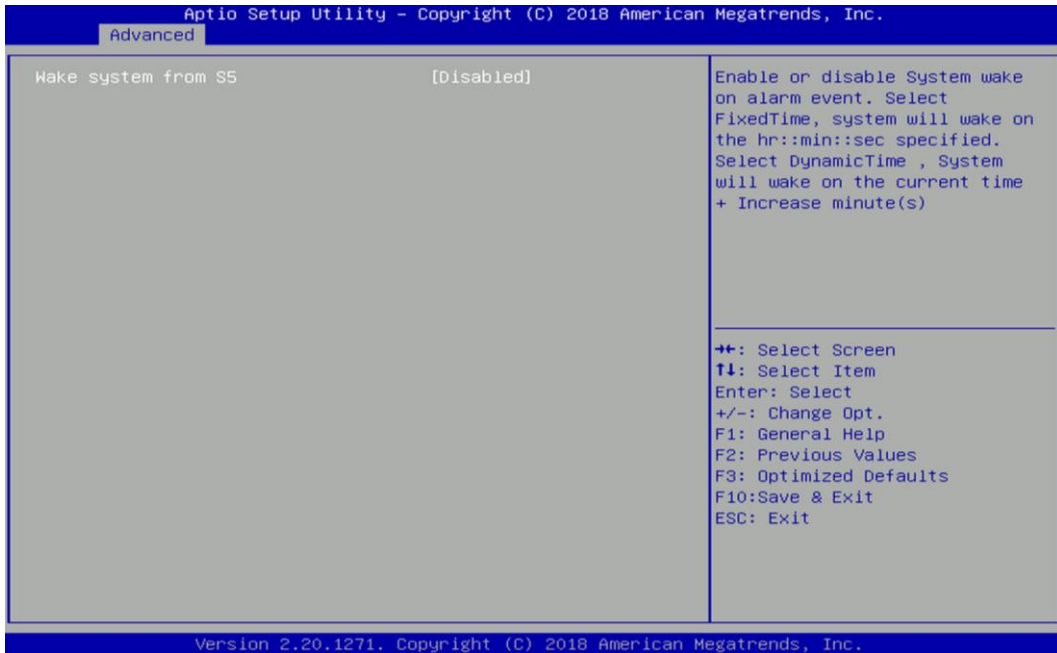

■ **Wake system from S5 [Disabled]**

Enables or disables wake system from S5 (soft-off state).

[Disabled]: Disables wake system from S5.

[Fixed Time]: Sets a fixed time (HH:MM:SS) to wake system from S5.

[Dynamic Time]: Sets an increase minute(s) from current time to wake system from S5.

4.3.9 Serial Port Console Redirection

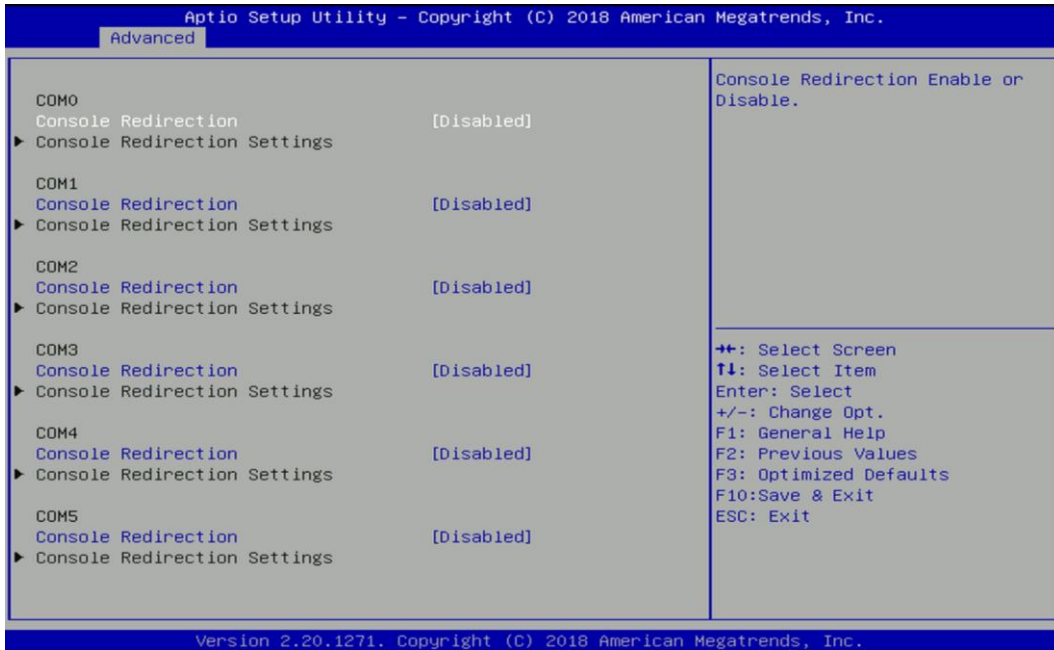

■ Console Redirection

Allow users to enable or disable COM0, COM1, COM2, COM3, COM4, COM5 console redirection function.

COM0 = Serial Port 1

COM1 = Serial Port 2

COM2 = Serial Port 3

COM3 = Serial Port 4

COM4 = Serial Port 5

COM5 = Serial Port 6

4.3.10 USB Configuration

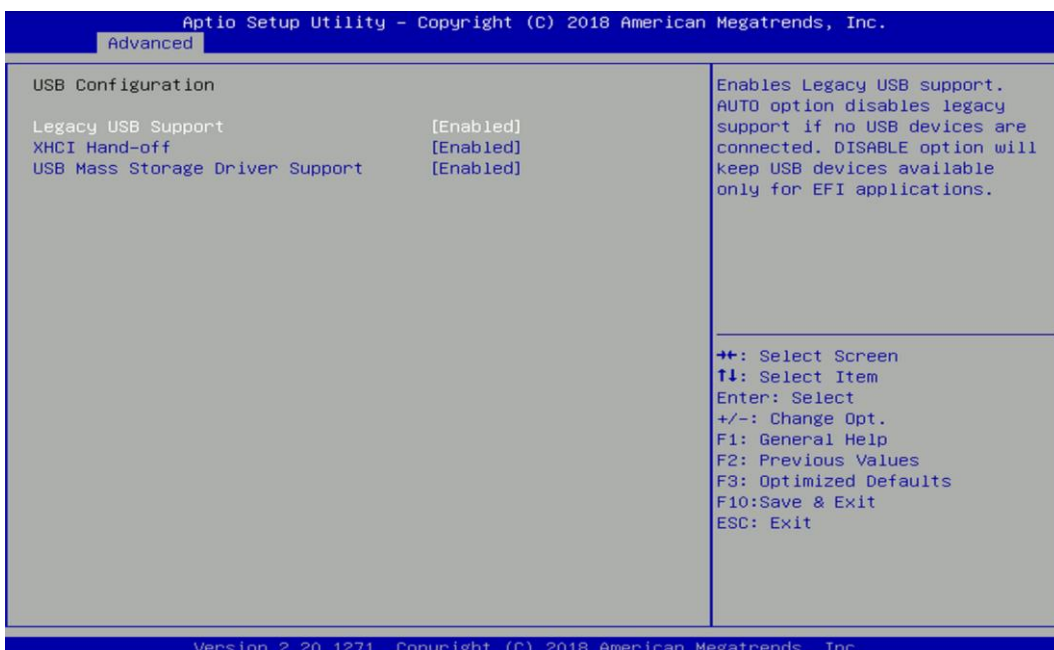

■ Legacy USB Support [Enabled]

This item allows you to enable or disable legacy USB support. When set to [Auto], legacy USB support will be disabled automatically if no USB devices are connected.

■ XHCI Hand-off [Enabled]

Enables or disables XHCI (USB3.0) hand-off function. Use this feature as a workaround for operating systems without XHCI hand-off support.

■ USB Mass Storage Driver Support [Enabled]

Enables or disables USB mass storage driver support.

4.3.11 Network Stack Configuration

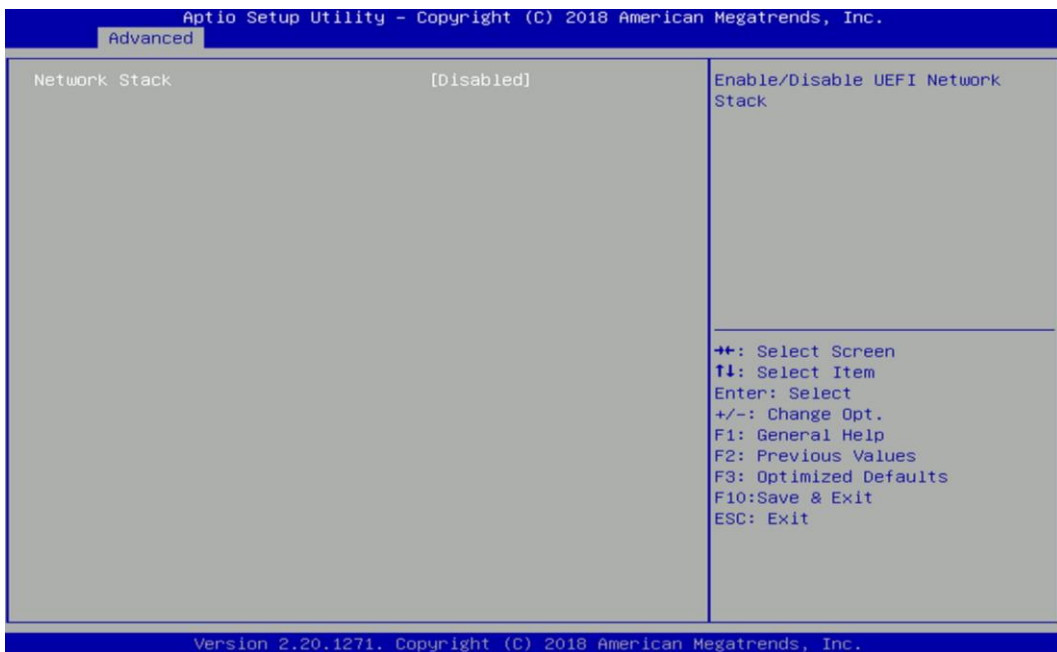

■ Network Stack [Disabled]

Enables or disables UEFI Network Stack.

4.3.12 CSM Configuration

This option controls legacy/UEFI ROMs priority.

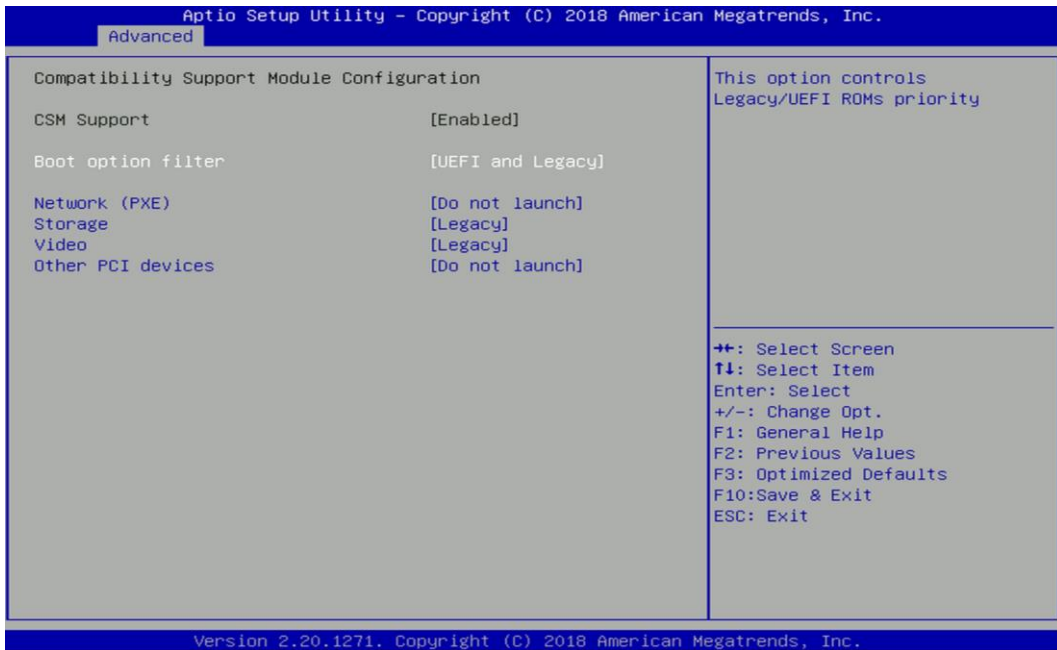

■ CSM Support [Enabled]

Enables or disables compatibility support module.

■ Boot option filter [UEFI and Legacy]

Allows you to select which type of operating system to boot.

[UEFI and Legacy]: Allows booting from operating systems that support legacy option ROM or UEFI option ROM.

[Legacy only]: Allows booting from operating systems that only support legacy option ROM.

[UEFI only]: Allows booting from operating systems that only support UEFI option ROM.

■ Network PXE [Do not launch]

Controls the execution of UEFI and Legacy PXE (Network Preboot eXecution Environment) option ROM.

[Do not launch]: Disables option ROM execution.

[UEFI]: Enables UEFI option ROM only.

[Legacy]: Enables legacy option ROM only.

■ Storage [Legacy]

Controls the execution of UEFI and Legacy Storage option ROM.

[Do not launch]: Disables option ROM execution.

[UEFI]: Enables UEFI option ROM only.

[Legacy]: Enables legacy option ROM only.

■ Video [Legacy]

Controls the execution of UEFI and Legacy Video option ROM.

[Do not launch]: Disables option ROM execution.

[UEFI]: Enables UEFI option ROM only.

[Legacy]: Enables legacy option ROM only.

■ Other PCI devices [Do not launch]

Allows users to determine option ROM execution policy for device other than network, storage, or video.

Configuration options: [Do not launch] [UEFI] [Legacy]

4.4 Chipset Setup

This section allows you to configure chipset related settings according to user's preference.

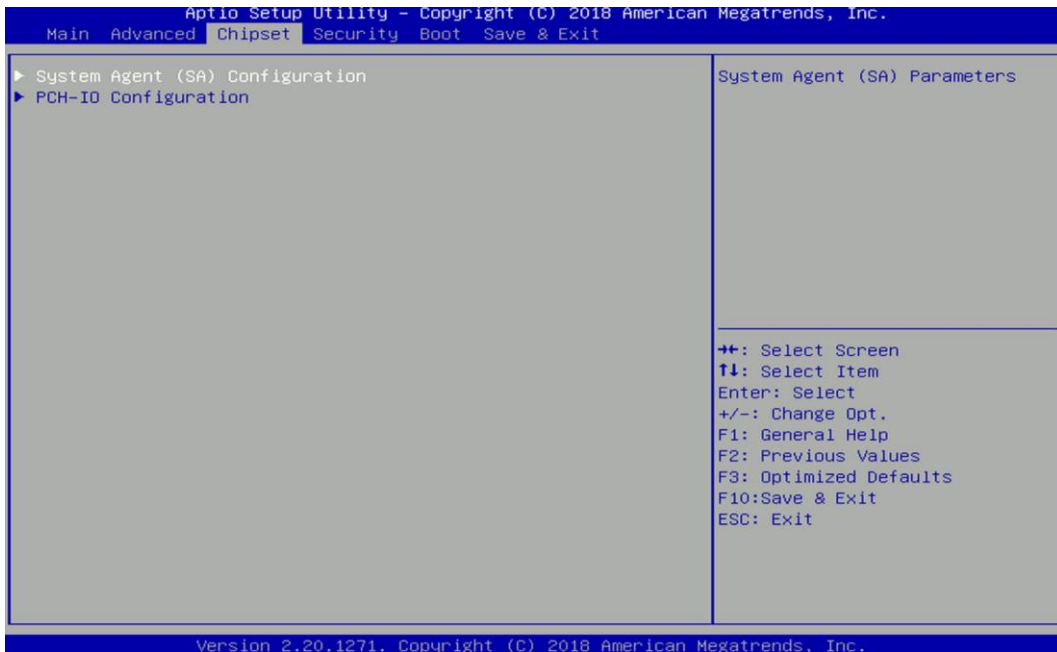

4.4.1 System Agent (SA) Configuration

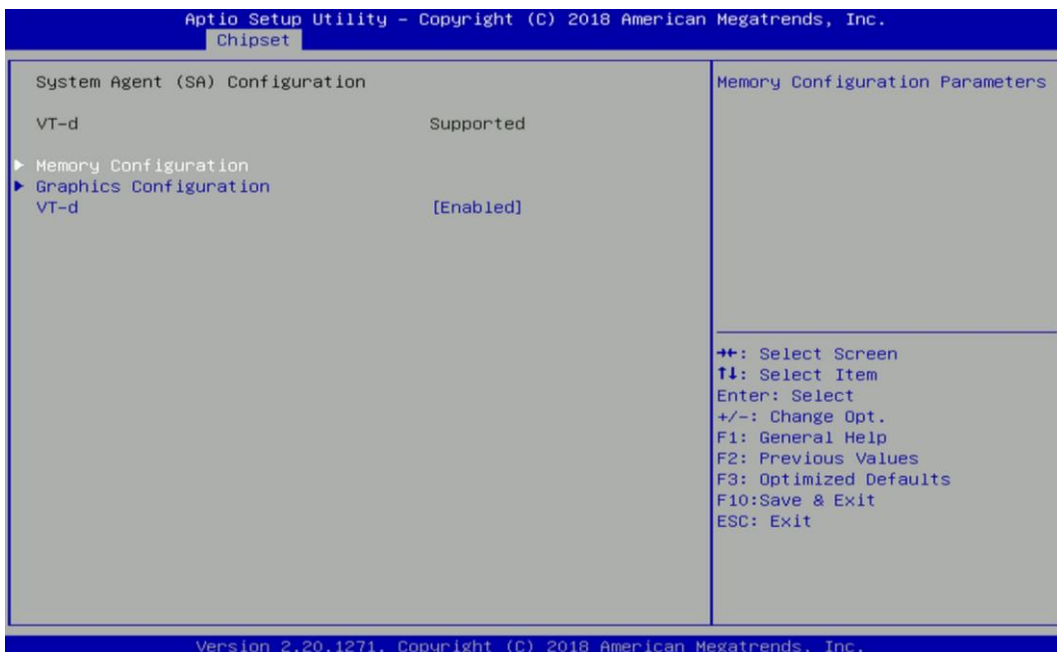

■ Memory Configuration

This item displays detailed memory configuration in the system.

■ Graphics Configuration

□ Internal Graphics [Auto]

Allows users to enable or disable Internal Graphics.

Configuration options: [Auto] [Disabled] [Enabled]

■ VT-d [Enabled]

Enables or disables Intel® Virtualization Technology for Directed I/O (VT-d) capability.

4.4.2 PCH-IO Configuration

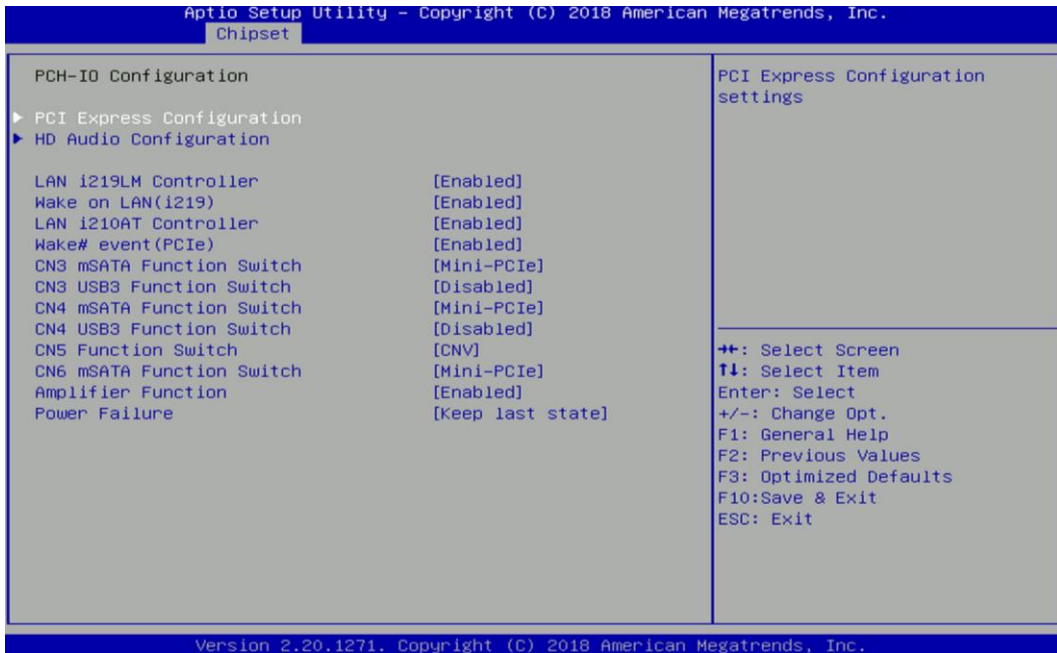

■ PCI Express Configuration

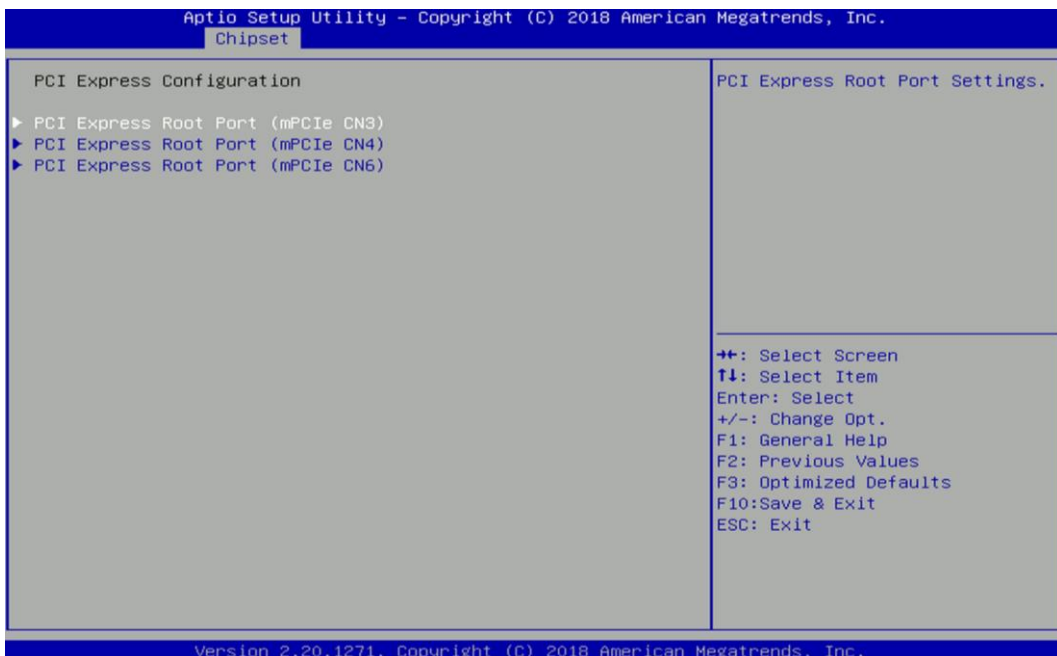

□ PCI Express Root Port (mPCIe CN3)

■ PCI Express Root Port [Enabled]

Enables or disables PCI Express Root Port.

■ PCIe Speed [Auto]

Allows you to select PCI Express interface speed.

Configuration options: [Auto] [Gen1] [Gen2] [Gen3].

PCI Express Root Port (mPCIe CN4)

■ **PCI Express Root Port [Enabled]**

Enables or disables PCI Express Root Port.

■ **PCIe Speed [Auto]**

Allows you to select PCI Express interface speed.

Configuration options: [Auto] [Gen1] [Gen2] [Gen3].

PCI Express Root Port (mPCIe CN6)

■ **PCI Express Root Port [Enabled]**

Enables or disables PCI Express Root Port.

■ **PCIe Speed [Auto]**

Allows you to select PCI Express interface speed.

Configuration options: [Auto] [Gen1] [Gen2] [Gen3].

■ **HD Audio Configuration**

HD Audio [Enabled]

Enables or disables HD Audio.

■ **LAN i219LM Controller [Enabled]**

Enables or disables I219-LM LAN Controller.

■ **Wake on LAN Enabled [Enabled]**

Enables or disables integrated LAN Wake On LAN function.

■ **LAN i210AT Controller [Enabled]**

Enables or disables I210 LAN Controller.

■ **CN3 mSATA Function Switch [Mini-PCIe]**

Allows you to change **mPCIe CN3** as [Mini-PCIe] or [mSATA].

■ **CN3 USB3 Function Switch [Disabled]**

Enables or disables CN3 USB3 Controller.

■ **CN4 mSATA Function Switch [Mini-PCIe]**

Allows you to change **mPCIe CN4** as [Mini-PCIe] or [mSATA].

■ **CN4 USB3 Function Switch [Disabled]**

Enables or disables CN4 USB3 Controller.

■ **CN5 mSATA Function Switch [CNV]**

Allows you to change **mPCIe CN5** as [CNV] or [WiFi].

■ **CN6 mSATA Function Switch [Mini-PCIe]**

Allows you to change **mPCIe CN6** as [Mini-PCIe] or [mSATA].

■ **Amplifier Function [Enabled]**

Enables or disables Amplifier Function.

■ **Power Failure [Keep last state]**

Allows you to specify which power state system will enter when power is resumed after a power failure (G3 state).

[Always on]: Enters to power on state.

[Always off]: Enters to power off state.

[Keep last state]: Enters to the last power state before a power failure.

4.5 Security Setup

This section allows users to configure BIOS security settings.

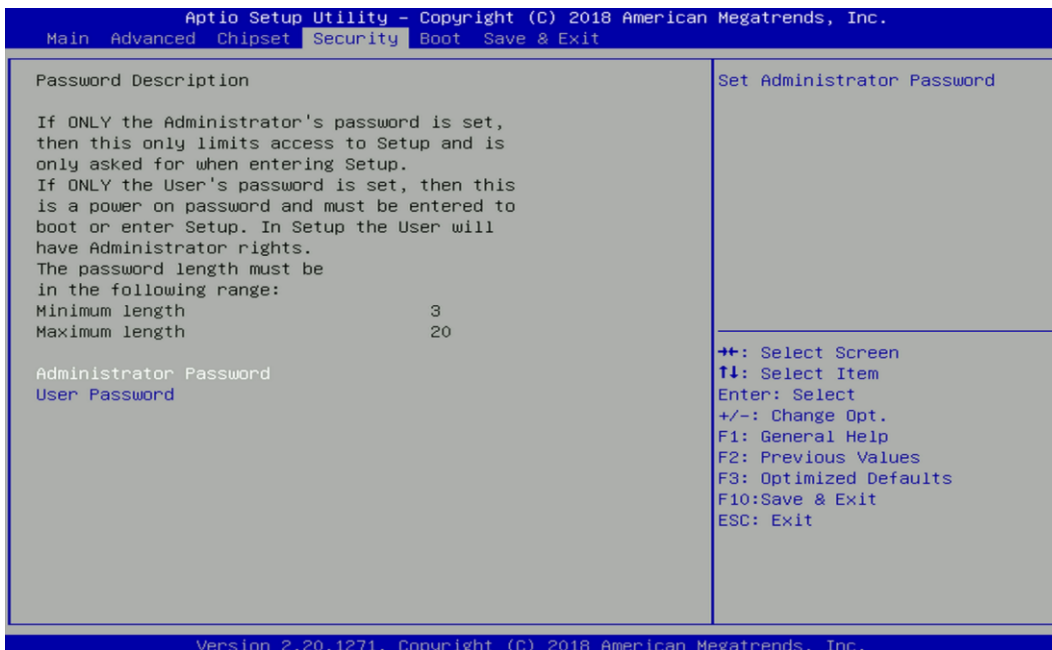

4.5.1 Administrator Password

Administrator Password controls access to the BIOS Setup utility.

4.5.2 User Password

User Password controls access to the system at boot and to the BIOS Setup utility.

4.6 Boot Setup

This section allows you to configure Boot settings.

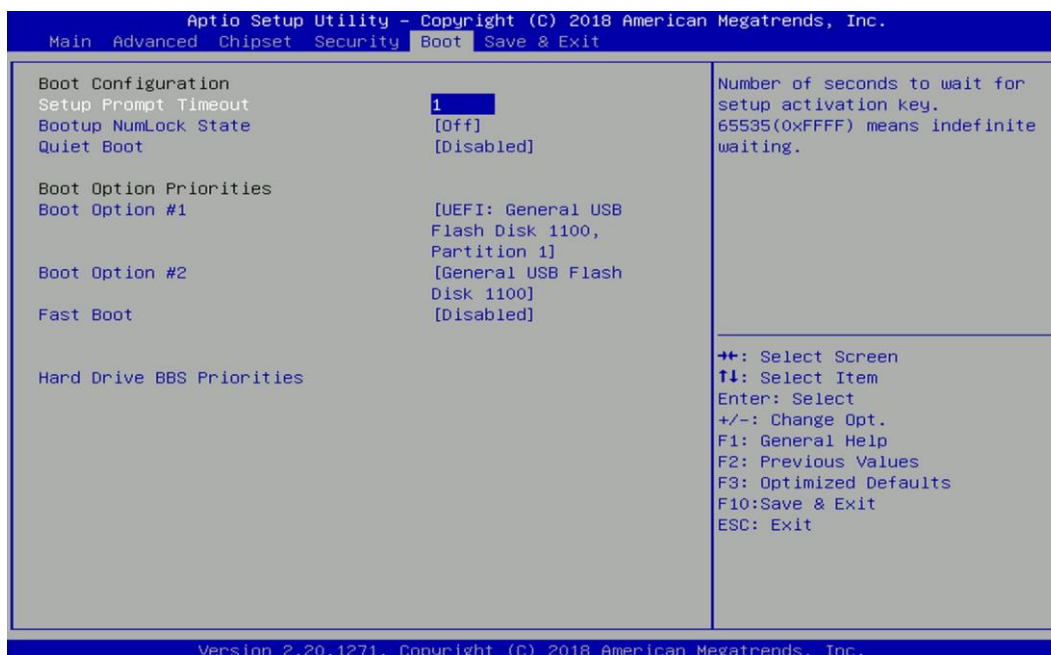

4.6.1 Setup Prompt Timeout

Use this item to set number of seconds (1..65535) to wait for setup activation key.

4.6.2 Bootup NumLock State

Allows you to set NumLock key to [On] or [Off] state when system boots up.

4.6.3 Quiet Boot

Allows you to enable or disable Quiet Boot function.

4.6.4 Fast Boot

Allows you to enable or disable Fast Boot function. If enabled, system boots with initialization of a minimal set of devices required to launch active boot option.

4.6.5 Hard Drive BBS Priority

Allows you to set the order of the legacy devices in this group.

4.7 Save & Exit

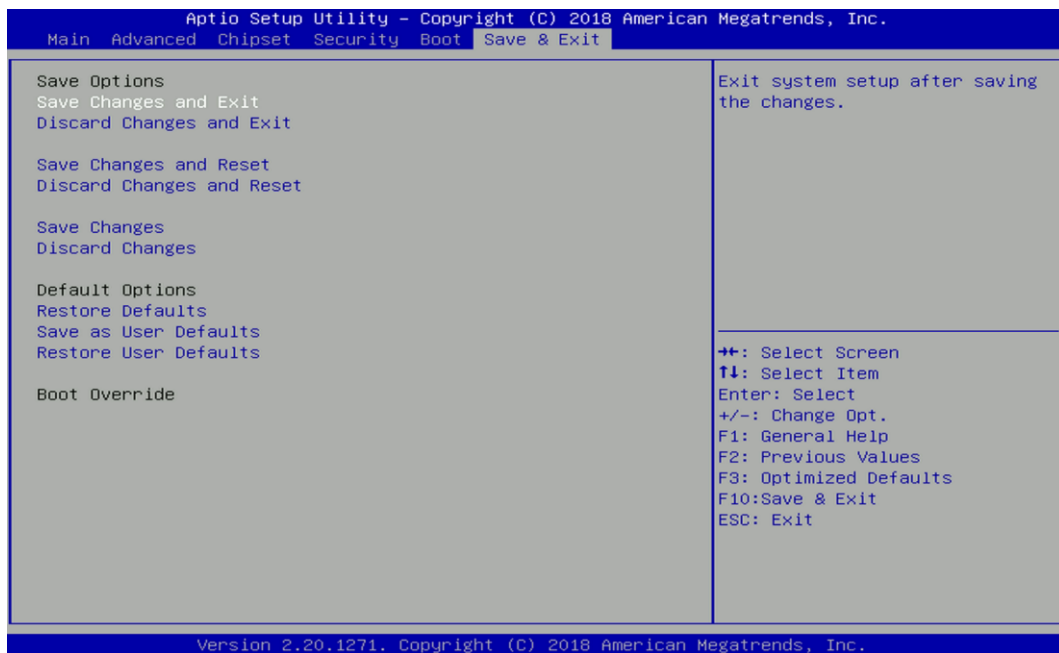

4.7.1 Save Changes and Exit

This item allows you to exit system setup after saving changes.

4.7.2 Discard Changes and Exit

This item allows you to exit system setup without saving changes.

4.7.3 Save Changes and Reset

This item allows you to reset the system after saving changes.

4.7.4 Discard Changes and Reset

This item allows you to reset system setup without saving any changes.

4.7.5 Save Changes

This item allows you to save changes done so far to any of the setup options.

4.7.6 Discard Changes.

This item allows you to discard changes done so far to any of the setup options.

4.7.7 Restore Defaults

This item allows you to restore/ load default values for all the setup options.

4.7.8 Save as User Defaults

This item allows you to save the changes done so far as user defaults.

4.7.9 Restore User Defaults

This item allows you to restore the user defaults to all the setup options.



Chapter 5

Product Application

(For DIO Only)

5.1 Digital I/O (DIO) application

This section describes DIO application of the product. The content and application development are better understood and implemented by well experienced professionals or developers.

5.1.1 Digital I/O Programming Guide

5.1.1.1 Pins for Digital I/O

Item	Standard
GPIO70 (Pin103)	DI
GPIO71 (Pin104)	
GPIO72 (Pin105)	
GPIO73 (Pin106)	
GPIO74 (Pin107)	
GPIO75 (Pin108)	
GPIO76 (Pin109)	
GPIO77 (Pin110)	
GPIO80 (Pin111)	DO
GPIO81 (Pin112)	
GPIO82 (Pin113)	
GPIO83 (Pin114)	
GPIO84 (Pin115)	
GPIO85 (Pin116)	
GPIO86 (Pin117)	
GPIO87 (Pin118)	

5.1.1.2 Programming Guide

To program the Super I/O chip F81866A configuration registers, the following configuration procedures must be followed in sequence:

- (1) Enter the Extended Function Mode
- (2) Configure the configuration registers
- (3) Exit the Extended Function Mode

The configuration register is used to control the behavior of the corresponding devices. To configure the register, use the index port to select the index and then write data port to alter the parameters. The default index port and data port are 0x4E and 0x4F, respectively.

Pull down the SOUT1 pin to change the default value to 0x2E/ 0x2F. To enable configuration, the entry key 0x87 must be written to the index port. To disable configuration, write exit entry key 0xAA to the index port.

Following is an example to enable configuration and to disable configuration by using debug.

- o 4e 87
- o 4e 87 (enable configuration)
- o 4e aa (disable configuration)

5.1.1.3 Relative Registers

To program the F81866A configuration registers, see the following configuration procedures.

Logic Device Number Register (LDN) — Index 07h

Bit	Name	R/W	Reset	Default	Description
7-0	LDN	R/W	LRESET#	00h	00h: Select FDC device configuration registers. 03h: Select Parallel Port device configuration registers. 04h: Select Hardware Monitor device configuration registers. 05h: Select KBC device configuration registers. 06h: Select GPIO device configuration registers. 07h: Select WDT device configuration registers. 0Ah: Select PME, ACPI and ERP device configuration registers. 10h: Select UART1 device configuration registers. 11h: Select UART2 device configuration registers. 12h: Select UART3 device configuration registers. 13h: Select UART4 device configuration registers. 14h: Select UART5 device configuration registers. 15h: Select UART6 device configuration registers. Otherwise: Reserved.

8.7.13.1 GPIO7 Output Enable Register — Index 80h

Bit	Name	R/W	Reset	Default	Description
7	GPIO77_OE	R/W	LRESET#	0	0: GPIO77 is in input mode. 1: GPIO77 is in output mode.
6	GPIO76_OE	R/W	LRESET#	0	0: GPIO76 is in input mode. 1: GPIO75 is in output mode.
5	GPIO75_OE	R/W	LRESET#	0	0: GPIO75 is in input mode. 1: GPIO75 is in output mode.
4	GPIO74_OE	R/W	LRESET#	0	0: GPIO74 is in input mode. 1: GPIO74 is in output mode.
3	GPIO73_OE	R/W	LRESET#	0	0: GPIO73 is in input mode. 1: GPIO73 is in output mode.
2	GPIO72_OE	R/W	LRESET#	0	0: GPIO72 is in input mode. 1: GPIO72 is in output mode.
1	GPIO71_OE	R/W	LRESET#	0	0: GPIO71 is in input mode. 1: GPIO71 is in output mode.
0	GPIO70_OE	R/W	LRESET#	0	0: GPIO70 is in input mode. 1: GPIO70 is in output mode.

8.7.13.3 GPIO7 Pin Status Register — Index 82h (This byte could be also read by base address + 3)

Bit	Name	R/W	Reset	Default	Description
7	GPIO77_IN	R	-	-	The pin status of GPIO77/STB#.
6	GPIO76_IN	R	-	-	The pin status of GPIO76/AFD#.
5	GPIO75_IN	R	-	-	The pin status of GPIO75/ERR#.
4	GPIO74_IN	R	-	-	The pin status of GPIO74/INIT#.
3	GPIO73_IN	R	-	-	The pin status of GPIO73/SLIN#.
2	GPIO72_IN	R	-	-	The pin status of GPIO72/ACK#.
1	GPIO71_IN	R	-	-	The pin status of GPIO71/BUSY.
0	GPIO70_IN	R	-	-	The pin status of GPIO70/PE/FANCTL3/PWM_DAC3.

8.7.14.2 GPIO8 Output Data Register — Index 89h (This byte could be also written by base address + 2)

Bit	Name	R/W	Reset	Default	Description
7	GPIO87_VAL	R/W	LRESET#	1	0: GPIO87 outputs 0 when in output mode. 1: GPIO87 outputs 1 when in output mode.
6	GPIO86_VAL	R/W	LRESET#	1	0: GPIO86 outputs 0 when in output mode. 1: GPIO86 outputs 1 when in output mode.
5	GPIO85_VAL	R/W	LRESET#	1	0: GPIO85 outputs 0 when in output mode. 1: GPIO85 outputs 1 when in output mode.
4	GPIO84_VAL	R/W	LRESET#	1	0: GPIO84 outputs 0 when in output mode. 1: GPIO84 outputs 1 when in output mode.
3	GPIO83_VAL	R/W	LRESET#	1	0: GPIO83 outputs 0 when in output mode. 1: GPIO83 outputs 1 when in output mode.
2	GPIO82_VAL	R/W	LRESET#	1	0: GPIO82 outputs 0 when in output mode. 1: GPIO82 outputs 1 when in output mode.
1	GPIO81_VAL	R/W	LRESET#	1	0: GPIO81 outputs 0 when in output mode. 1: GPIO81 outputs 1 when in output mode.
0	GPIO80_VAL	R/W	LRESET#	1	0: GPIO80 outputs 0 when in output mode. 1: GPIO80 outputs 1 when in output mode.

8.7.14.1 GPIO8 Output Enable Register — Index 88h

Bit	Name	R/W	Reset	Default	Description
7	GPIO87_OE	R/W	LRESET#	1	0: GPIO87 is in input mode. 1: GPIO87 is in output mode.
6	GPIO86_OE	R/W	LRESET#	1	0: GPIO86 is in input mode. 1: GPIO85 is in output mode.
5	GPIO85_OE	R/W	LRESET#	1	0: GPIO85 is in input mode. 1: GPIO85 is in output mode.
4	GPIO84_OE	R/W	LRESET#	1	0: GPIO84 is in input mode. 1: GPIO84 is in output mode.
3	GPIO83_OE	R/W	LRESET#	1	0: GPIO83 is in input mode. 1: GPIO83 is in output mode.
2	GPIO82_OE	R/W	LRESET#	1	0: GPIO82 is in input mode. 1: GPIO82 is in output mode.
1	GPIO81_OE	R/W	LRESET#	1	0: GPIO81 is in input mode. 1: GPIO81 is in output mode.
0	GPIO80_OE	R/W	LRESET#	1	0: GPIO80 is in input mode. 1: GPIO80 is in output mode.

5.1.1.4 Sample Code in C Language

5.1.1.4.1 Control of GP70 to GP77 (DI1 ~ DI8)

```
#define AddrPort 0x4E
```

```
#define DataPort 0x4F
```

<Enter the Extended Function Mode>

```
WriteByte(AddrPort, 0x87)
```

```
WriteByte(AddrPort, 0x87) // Must write twice to enter Extended mode
```

<Select Logic Device>

```
WriteByte(AddrPort, 0x07)
```

```
WriteByte(dataPort, 0x06) // Select logic device 06h
```

<Output/Input Mode Selection> // Set GP70 to GP77 input Mode

```
WriteByte(AddrPort, 0x80) // Select configuration register 80h
```

```
WriteByte(DataPort, 0x0X) // Set (bit 0~7) = 0 to select GP 70~77 as Input mode.
```

<Input Value>

```
WriteByte(AddrPort, 0x82) // Select configuration register 82h
```

```
ReadByte(DataPort, Value) // Read bit 0~7 (0xFF)= GP70 ~77 as High.
```

<Leave the Extended Function Mode>

```
WriteByte(AddrPort, 0xAA)
```

5.1.1.4.2 Control of GP80 to GP87 (DO1 ~ DO8)

```
#define AddrPort 0x4E
#define DataPort 0x4F

<Enter the Extended Function Mode>
WriteByte(AddrPort, 0x87)
WriteByte(AddrPort, 0x87) // Must write twice to enter Extended mode

<Select Logic Device>
WriteByte(AddrPort, 0x07)
WriteByte(DataPort, 0x06) // Select logic device 06h

<Output/Input Mode Selection> // Set GP80 to GP87 output Mode
WriteByte(AddrPort, 0x88) // Select configuration register 88h
WriteByte(DataPort, 0xFF) // Set (bit 0~7) = 1 to select GP 80 ~87 as Output mode.

<Output Value>
WriteByte(AddrPort, 0x89) // Select configuration register 89h
WriteByte(DataPort, Value) // Set bit 0~7=(0/1) to output GP 80~87 as Low or High

<Leave the Extended Function Mode>
WriteByte(AddrPort, 0xAA)
```

5.1.1.5 Change base address

```
<Enter the Extended Function Mode>
WriteByte(AddrPort, 0x87)
WriteByte(AddrPort, 0x87) // Must write twice to enter Extended mode

<Select Logic Device>
WriteByte(AddrPort, 0x07)
WriteByte(dataPort, 0x06) // Select logic device 06h

WriteByte(AddrPort, 0x60) // Select configuration register 60h (High Byte address)
WriteByte(DataPort, (0x0A))

WriteByte(AddrPort, 0x61) // Select configuration register 61h (Low Byte address)
WriteByte(DataPort, (0x00))

<Leave the Extended Function Mode>
WriteByte(AddrPort, 0xAA)
```

Cincoze default GPIO Port base address is 0xA00h

5.1.1.6 DATA Bit Table (DIO)

<table border="1"> <tr><td>7</td><td>6</td><td>5</td><td>4</td><td>3</td><td>2</td><td>1</td><td>0</td><td>bit</td></tr> <tr><td>0</td><td>0</td><td>0</td><td>0</td><td>0</td><td>0</td><td>0</td><td>1</td><td>Value</td></tr> <tr><td colspan="8">1</td><td>/h</td></tr> </table>	7	6	5	4	3	2	1	0	bit	0	0	0	0	0	0	0	1	Value	1								/h	<p>= DI1 (Base address +3) (0xA03)</p>	<table border="1"> <tr><td>7</td><td>6</td><td>5</td><td>4</td><td>3</td><td>2</td><td>1</td><td>0</td><td>bit</td></tr> <tr><td>0</td><td>0</td><td>0</td><td>0</td><td>0</td><td>0</td><td>0</td><td>1</td><td>Value</td></tr> <tr><td colspan="8">1</td><td>/h</td></tr> </table>	7	6	5	4	3	2	1	0	bit	0	0	0	0	0	0	0	1	Value	1								/h	<p>= DO1 (Base address +2) (0xA02)</p>
7	6	5	4	3	2	1	0	bit																																																	
0	0	0	0	0	0	0	1	Value																																																	
1								/h																																																	
7	6	5	4	3	2	1	0	bit																																																	
0	0	0	0	0	0	0	1	Value																																																	
1								/h																																																	
<table border="1"> <tr><td>7</td><td>6</td><td>5</td><td>4</td><td>3</td><td>2</td><td>1</td><td>0</td><td>bit</td></tr> <tr><td>0</td><td>0</td><td>0</td><td>0</td><td>0</td><td>0</td><td>1</td><td>0</td><td>Value</td></tr> <tr><td colspan="8">2</td><td>/h</td></tr> </table>	7	6	5	4	3	2	1	0	bit	0	0	0	0	0	0	1	0	Value	2								/h	<p>= DI2 (Base address +3) (0xA03)</p>	<table border="1"> <tr><td>7</td><td>6</td><td>5</td><td>4</td><td>3</td><td>2</td><td>1</td><td>0</td><td>bit</td></tr> <tr><td>0</td><td>0</td><td>0</td><td>0</td><td>0</td><td>0</td><td>1</td><td>0</td><td>Value</td></tr> <tr><td colspan="8">2</td><td>/h</td></tr> </table>	7	6	5	4	3	2	1	0	bit	0	0	0	0	0	0	1	0	Value	2								/h	<p>= DO2 Base address +2) (0xA02)</p>
7	6	5	4	3	2	1	0	bit																																																	
0	0	0	0	0	0	1	0	Value																																																	
2								/h																																																	
7	6	5	4	3	2	1	0	bit																																																	
0	0	0	0	0	0	1	0	Value																																																	
2								/h																																																	
<table border="1"> <tr><td>7</td><td>6</td><td>5</td><td>4</td><td>3</td><td>2</td><td>1</td><td>0</td><td>bit</td></tr> <tr><td>0</td><td>0</td><td>0</td><td>0</td><td>0</td><td>1</td><td>0</td><td>0</td><td>Value</td></tr> <tr><td colspan="8">4</td><td>/h</td></tr> </table>	7	6	5	4	3	2	1	0	bit	0	0	0	0	0	1	0	0	Value	4								/h	<p>= DI3 (Base address +3) (0xA03)</p>	<table border="1"> <tr><td>7</td><td>6</td><td>5</td><td>4</td><td>3</td><td>2</td><td>1</td><td>0</td><td>bit</td></tr> <tr><td>0</td><td>0</td><td>0</td><td>0</td><td>0</td><td>1</td><td>0</td><td>0</td><td>Value</td></tr> <tr><td colspan="8">4</td><td>/h</td></tr> </table>	7	6	5	4	3	2	1	0	bit	0	0	0	0	0	1	0	0	Value	4								/h	<p>= DO3 Base address +2) (0xA02)</p>
7	6	5	4	3	2	1	0	bit																																																	
0	0	0	0	0	1	0	0	Value																																																	
4								/h																																																	
7	6	5	4	3	2	1	0	bit																																																	
0	0	0	0	0	1	0	0	Value																																																	
4								/h																																																	
<table border="1"> <tr><td>7</td><td>6</td><td>5</td><td>4</td><td>3</td><td>2</td><td>1</td><td>0</td><td>bit</td></tr> <tr><td>0</td><td>0</td><td>0</td><td>0</td><td>1</td><td>0</td><td>0</td><td>0</td><td>Value</td></tr> <tr><td colspan="8">8</td><td>/h</td></tr> </table>	7	6	5	4	3	2	1	0	bit	0	0	0	0	1	0	0	0	Value	8								/h	<p>= DI4 (Base address +3) (0xA03)</p>	<table border="1"> <tr><td>7</td><td>6</td><td>5</td><td>4</td><td>3</td><td>2</td><td>1</td><td>0</td><td>bit</td></tr> <tr><td>0</td><td>0</td><td>0</td><td>0</td><td>1</td><td>0</td><td>0</td><td>0</td><td>Value</td></tr> <tr><td colspan="8">8</td><td>/h</td></tr> </table>	7	6	5	4	3	2	1	0	bit	0	0	0	0	1	0	0	0	Value	8								/h	<p>= DO4 Base address +2) (0xA02)</p>
7	6	5	4	3	2	1	0	bit																																																	
0	0	0	0	1	0	0	0	Value																																																	
8								/h																																																	
7	6	5	4	3	2	1	0	bit																																																	
0	0	0	0	1	0	0	0	Value																																																	
8								/h																																																	
<table border="1"> <tr><td>7</td><td>6</td><td>5</td><td>4</td><td>3</td><td>2</td><td>1</td><td>0</td><td>bit</td></tr> <tr><td>0</td><td>0</td><td>0</td><td>1</td><td>0</td><td>0</td><td>0</td><td>0</td><td>Value</td></tr> <tr><td colspan="8">10</td><td>/h</td></tr> </table>	7	6	5	4	3	2	1	0	bit	0	0	0	1	0	0	0	0	Value	10								/h	<p>= DI5 (Base address +3) (0xA03)</p>	<table border="1"> <tr><td>7</td><td>6</td><td>5</td><td>4</td><td>3</td><td>2</td><td>1</td><td>0</td><td>bit</td></tr> <tr><td>0</td><td>0</td><td>0</td><td>1</td><td>0</td><td>0</td><td>0</td><td>0</td><td>Value</td></tr> <tr><td colspan="8">10</td><td>/h</td></tr> </table>	7	6	5	4	3	2	1	0	bit	0	0	0	1	0	0	0	0	Value	10								/h	<p>= DO5 Base address +2) (0xA02)</p>
7	6	5	4	3	2	1	0	bit																																																	
0	0	0	1	0	0	0	0	Value																																																	
10								/h																																																	
7	6	5	4	3	2	1	0	bit																																																	
0	0	0	1	0	0	0	0	Value																																																	
10								/h																																																	
<table border="1"> <tr><td>7</td><td>6</td><td>5</td><td>4</td><td>3</td><td>2</td><td>1</td><td>0</td><td>bit</td></tr> <tr><td>0</td><td>0</td><td>1</td><td>0</td><td>0</td><td>0</td><td>0</td><td>0</td><td>Value</td></tr> <tr><td colspan="8">20</td><td>/h</td></tr> </table>	7	6	5	4	3	2	1	0	bit	0	0	1	0	0	0	0	0	Value	20								/h	<p>= DI6 (Base address +3) (0xA03)</p>	<table border="1"> <tr><td>7</td><td>6</td><td>5</td><td>4</td><td>3</td><td>2</td><td>1</td><td>0</td><td>bit</td></tr> <tr><td>0</td><td>0</td><td>1</td><td>0</td><td>0</td><td>0</td><td>0</td><td>0</td><td>Value</td></tr> <tr><td colspan="8">20</td><td>/h</td></tr> </table>	7	6	5	4	3	2	1	0	bit	0	0	1	0	0	0	0	0	Value	20								/h	<p>= DO6 Base address +2) (0xA02)</p>
7	6	5	4	3	2	1	0	bit																																																	
0	0	1	0	0	0	0	0	Value																																																	
20								/h																																																	
7	6	5	4	3	2	1	0	bit																																																	
0	0	1	0	0	0	0	0	Value																																																	
20								/h																																																	
<table border="1"> <tr><td>7</td><td>6</td><td>5</td><td>4</td><td>3</td><td>2</td><td>1</td><td>0</td><td>bit</td></tr> <tr><td>0</td><td>1</td><td>0</td><td>0</td><td>0</td><td>0</td><td>0</td><td>0</td><td>Value</td></tr> <tr><td colspan="8">40</td><td>/h</td></tr> </table>	7	6	5	4	3	2	1	0	bit	0	1	0	0	0	0	0	0	Value	40								/h	<p>= DI7 (Base address +3) (0xA03)</p>	<table border="1"> <tr><td>7</td><td>6</td><td>5</td><td>4</td><td>3</td><td>2</td><td>1</td><td>0</td><td>bit</td></tr> <tr><td>0</td><td>1</td><td>0</td><td>0</td><td>0</td><td>0</td><td>0</td><td>0</td><td>Value</td></tr> <tr><td colspan="8">40</td><td>/h</td></tr> </table>	7	6	5	4	3	2	1	0	bit	0	1	0	0	0	0	0	0	Value	40								/h	<p>= DO7 Base address +2) (0xA02)</p>
7	6	5	4	3	2	1	0	bit																																																	
0	1	0	0	0	0	0	0	Value																																																	
40								/h																																																	
7	6	5	4	3	2	1	0	bit																																																	
0	1	0	0	0	0	0	0	Value																																																	
40								/h																																																	
<table border="1"> <tr><td>7</td><td>6</td><td>5</td><td>4</td><td>3</td><td>2</td><td>1</td><td>0</td><td>bit</td></tr> <tr><td>1</td><td>0</td><td>0</td><td>0</td><td>0</td><td>0</td><td>0</td><td>0</td><td>Value</td></tr> <tr><td colspan="8">80</td><td>/h</td></tr> </table>	7	6	5	4	3	2	1	0	bit	1	0	0	0	0	0	0	0	Value	80								/h	<p>= DI8 (Base address +3) (0xA03)</p>	<table border="1"> <tr><td>7</td><td>6</td><td>5</td><td>4</td><td>3</td><td>2</td><td>1</td><td>0</td><td>bit</td></tr> <tr><td>1</td><td>0</td><td>0</td><td>0</td><td>0</td><td>0</td><td>0</td><td>0</td><td>Value</td></tr> <tr><td colspan="8">80</td><td>/h</td></tr> </table>	7	6	5	4	3	2	1	0	bit	1	0	0	0	0	0	0	0	Value	80								/h	<p>= DO8 Base address +2) (0xA02)</p>
7	6	5	4	3	2	1	0	bit																																																	
1	0	0	0	0	0	0	0	Value																																																	
80								/h																																																	
7	6	5	4	3	2	1	0	bit																																																	
1	0	0	0	0	0	0	0	Value																																																	
80								/h																																																	

5.1.1.7 DIO I/O Port Address (Default Address 0xA00)

DI8	DI7	DI6	DI5	DI4	DI3	DI2	DI1	DO8	DO7	DO6	DO5	DO4	DO3	DO2	DO1	Pin Definition
7	6	5	4	3	2	1	0	7	6	5	4	3	2	1	0	Data Bits
DI								DO								DIO
0xA03								0xA02								I/O Port address

5.2 DIO Hardware Specification

- XCOM+: Isolated power in V+
- XCOM-: Isolated power in V-
- Isolated power in DC voltage: 9~30V
- 8x Digital Input (Source Type)
- Input Signal Voltage Level
 - Signal Logic 0: XCOM+ = 9V, [Signal Low](#) - [V-](#) < 1V
XCOM+ > 9V, [V+](#) - [Signal Low](#) > 8V
 - Signal Logic 1: > [XCOM+](#) - [3V](#)
- Input Driving Sink Current:
 - Minimal: 1 mA
 - Normal: 5 mA
- 8x Digital Output (Open Drain)
 - DO Signal have to pull up resistor to XCOM+ for external device, the resistance will affect the pull up current
 - Signal High Level: Pull up resistor to XCOM+
 - Signal Low Level: = XCOM-
 - Sink Current: 1A (Max)

5.2.1 DIO Connector Definition

DIO1/DIO2: Digital Input / Output Connector

Connector Type: Terminal Block 2X10 10-pin, 3.5mm pitch

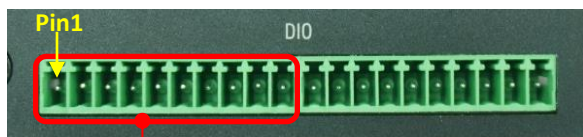

DIO1 (Digital Input)

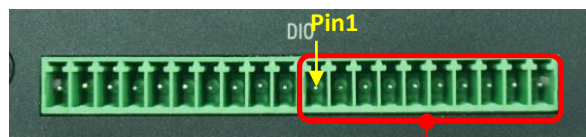

DIO2 (Digital Input)

Location	Pin	Definition
DIO1	1	DC INPUT (XCOM+)
	2	DI1
	3	DI2
	4	DI3
	5	DI4
	6	DI5
	7	DI6
	8	DI7
	9	DI8
	10	GND (XCOM-)

Location	Pin	Definition
DIO2	1	DC INPUT (XCOM+)
	2	DO1
	3	DO2
	4	DO3
	5	DO4
	6	DO5
	7	DO6
	8	DO7
	9	DO8
	10	GND (XCOM-)

Reference Input Circuit

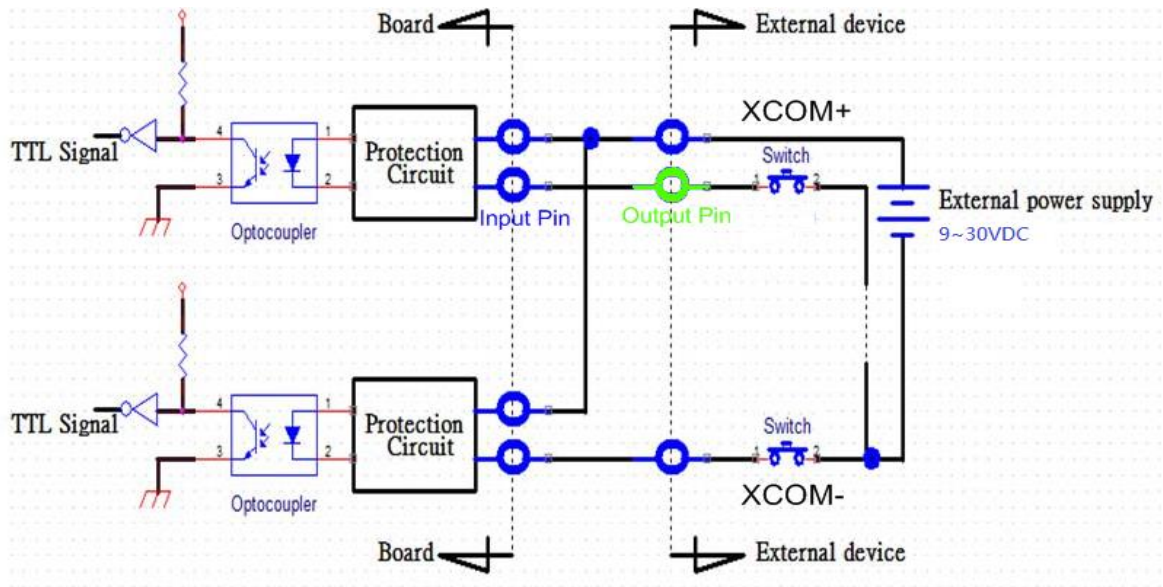

Reference Output Circuit

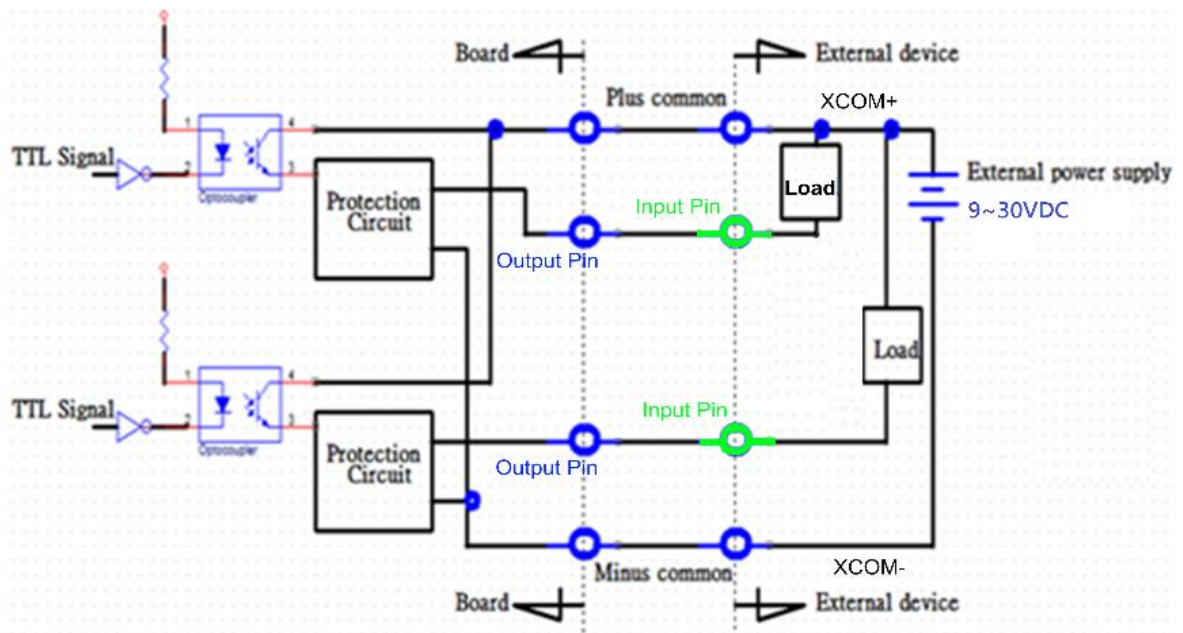



Chapter 6

Optional Modules

Pin Definitions and Settings

6.1 CMI-COM Connector Definition and Settings

Model No.	Product Description
CMI-COM01/UB0903	CMI Module with 2x RS232/422/485 (Support 5V/12V) / 1x Universal Bracket with 2x DB9 Cutout for DX Series

COM5 / COM6: RS232 / RS422 / RS485 Connector

Connector Type: 9-pin D-Sub

Pin	RS232 Definition	RS422 / 485 Full Duplex Definition	RS485 Half Duplex Definition
1	DCD	TX-	DATA -
2	RXD	TX+	DATA +
3	TXD	RX+	
4	DTR	RX-	
5	GND		
6	DSR		
7	RTS		
8	CTS		
9	RI		

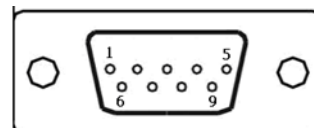

SW2: COM5/COM6 Power Select

Location	Function	DIP1	DIP2
SW2 on CMI-COM Module	COM5	0V(RI)	ON (Default)
		5V	ON
		12V	OFF

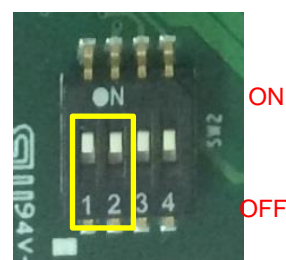

Location	Function	DIP3	DIP4
SW2 on CMI-COM Module	COM6	0V(RI)	ON (Default)
		5V	ON
		12V	OFF

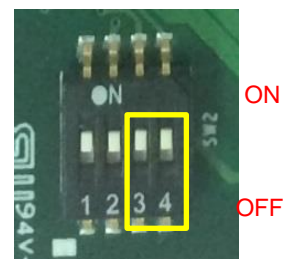

6.2 CMI-M12 Connector Definition and Settings

CMI-M12LAN01 Module Pin Definitions

Connector Type: M12 A coded 8pin connector

Pin	Definition	Pin	Definition
1	2_LAN1_0+	2	2_LAN1_0-
3	2_LAN1_1+	4	2_LAN1_2+
5	2_LAN1_2-	6	2_LAN1_1-
7	2_LAN1_3+	8	2_LAN1_3-

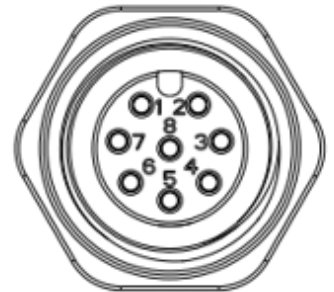

CMI-XM12LAN01 Module Pin Definitions

Connector Type: M12 X coded 8pin connector

Pin	Definition	Pin	Definition
1	D1+	2	D1-
3	D2+	4	D2-
5	D4+	6	D4-
7	D3-	8	D3+

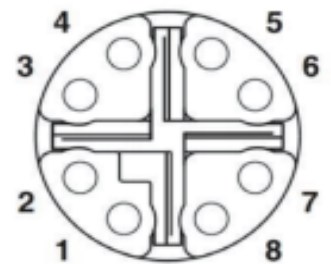

6.3 CFM-IGN Switch Definition and Settings

Model No.	Product Description
CFM-IGN01	CFM Module with Power Ignition Sensing Control Function, 12V/24V Selectable

SW2: IGN Module Timing Setting Switch

Set shutdown delay timer when ACC is turned off

Pin 1	Pin 2	Pin 3	Pin 4	Definition
ON	ON	ON	ON (IGN enabled)	0 second
ON	ON	OFF		1 minute
ON	OFF	ON		5 minutes
ON	OFF	OFF		10 minutes
OFF	ON	ON		30 minutes
OFF	ON	OFF		1 hour
OFF	OFF	ON		2 hours
OFF	OFF	OFF		Reserved (0 second)
				OFF (IGN disabled)

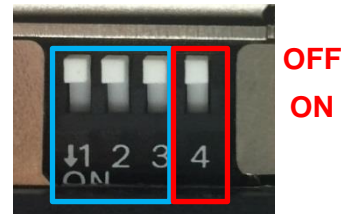

24V_12V_1: IGN Module Voltage Mode Setting Switch

12V / 24V Car Battery Switch

Pin	Definition
1-2	24V Car Battery Input (Default)
2-3	12V Car Battery Input



6.4 Installing a CMI-COM Module

Model No.	Product Description
CMI-COM01/UB0903	CMI Module with 2x RS232/422/485 (Support 5V/12V) / 1x Universal Bracket with 2x DB9 Cutout for DX Series

1. Locate the connector of CMI-module on the bottom side of system.

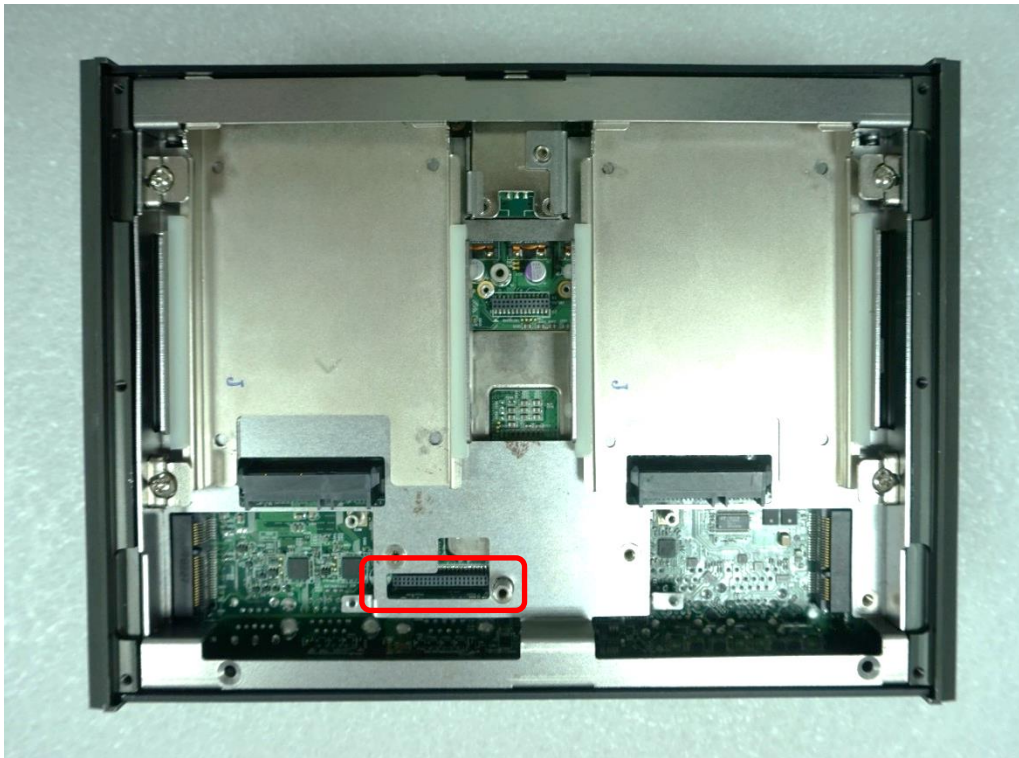

2. Loosen the 2 screws on rear bezel to remove the cover plate.



3. Insert the CMI-COM module carefully into the CMI connector on main board. Fix it with 2 screws.



4. Loosen the 4 D-Sub jack screws as marked on photo.

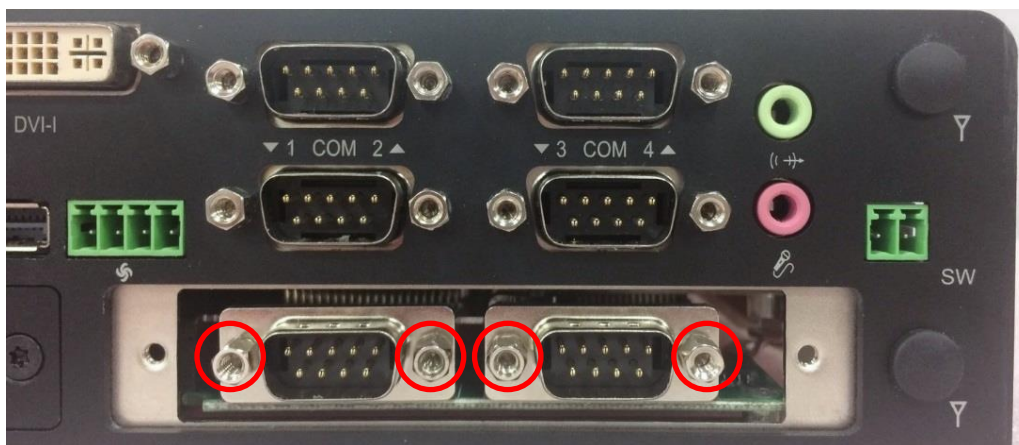

5. Attach the COM bracket. Fasten 2 screws and 4 D-Sub jack screws to fix it.



6.5 Installing a CMI-DIO Module

Model No.	Product Description
CMI-DIO01/UB0918	CMI Module with 16DIO (8in 8out) / 1xUniversal Bracket with DIO Cutout for DX Series

1. Locate the connector of CMI-DIO module on the bottom side of system.

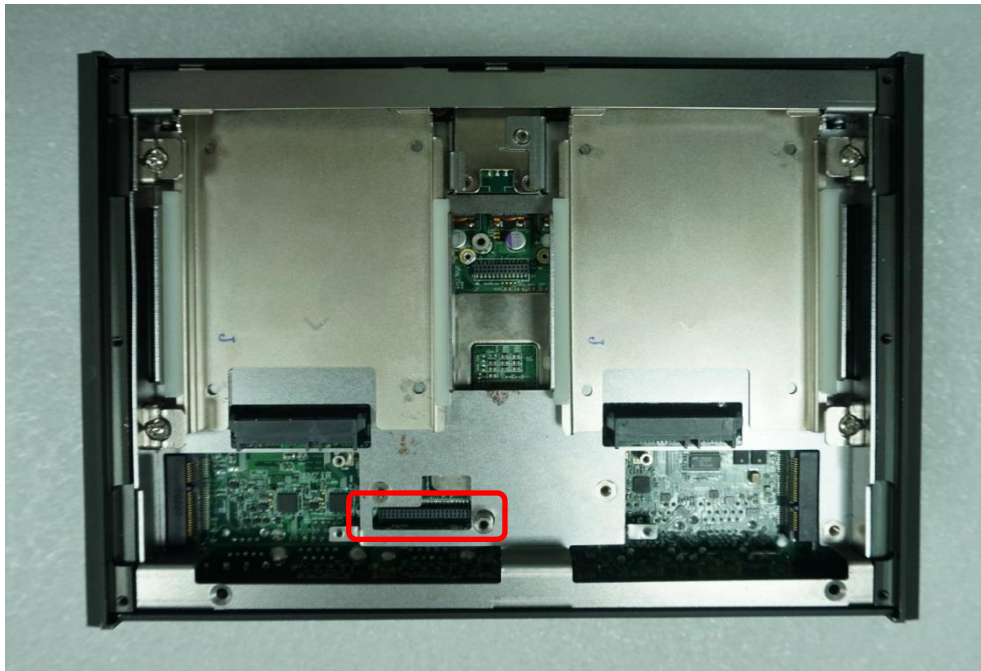

2. Loosen the 2 screws on rear bezel to remove the cover plate.



3. Insert the CMI-DIO module carefully into the CMI connector on main board. Fix it with 2 screws.

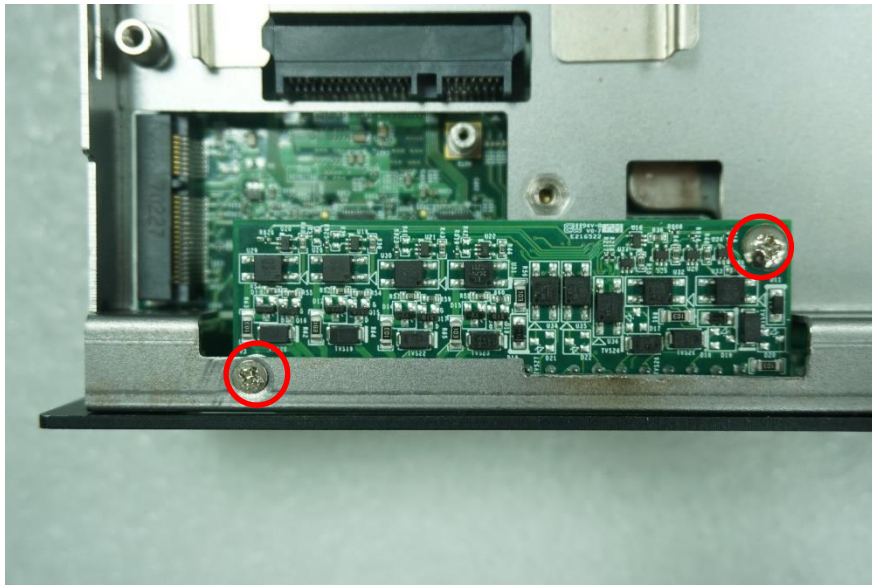

4. Attach the DIO bracket, and fasten 2 screws to fix it.



6.6 Installing a High Speed CMI Module

The applicable high speed CMI modules for DX-1100 series are CMI-LAN01-R12/UB0912, CMI-M12LAN01-R12/UB0910, and CMI-XM12LAN01-R10/UB0930.

6.6.1 CMI-M12LAN01-R12/UB1310 module

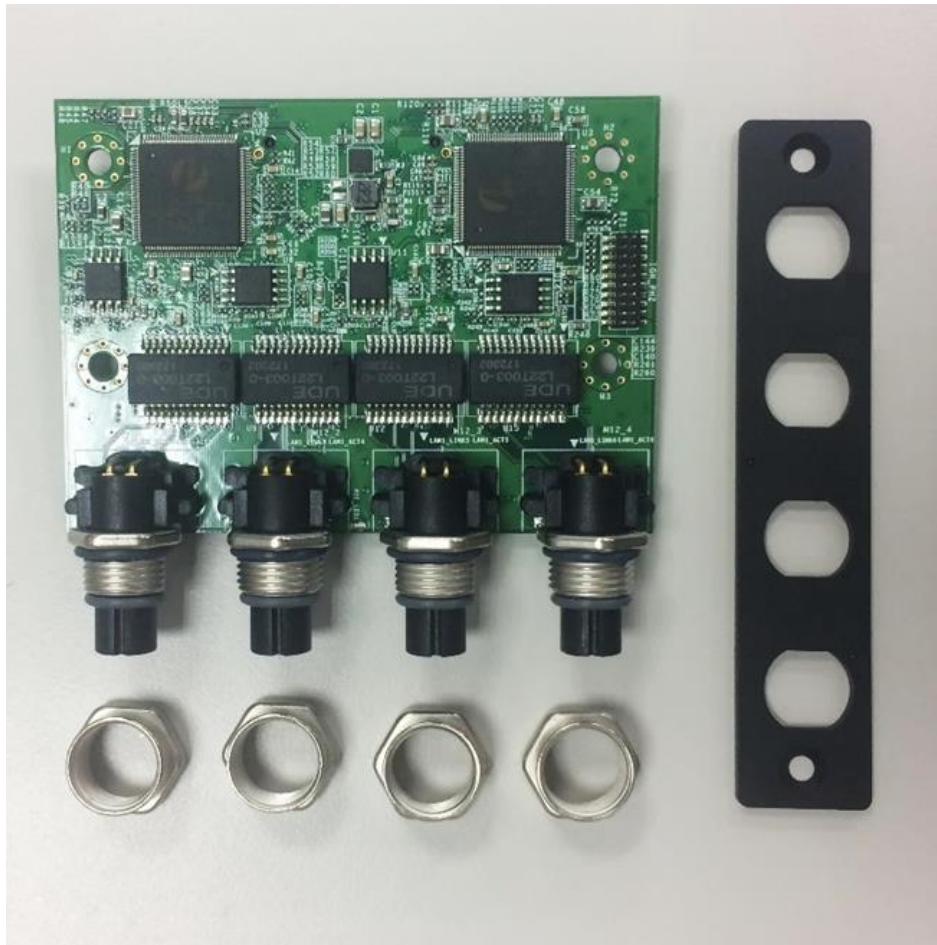

1. Loosen the 2 screws on front bezel to remove the cover plate.



2. Remove 4 rubber rings on M12 jacks; Penetrate M12 jacks of CMI module through the accompanying M12 I/O bracket. then fasten 4 ring hexes onto jacks as illustrated in right hand picture below.

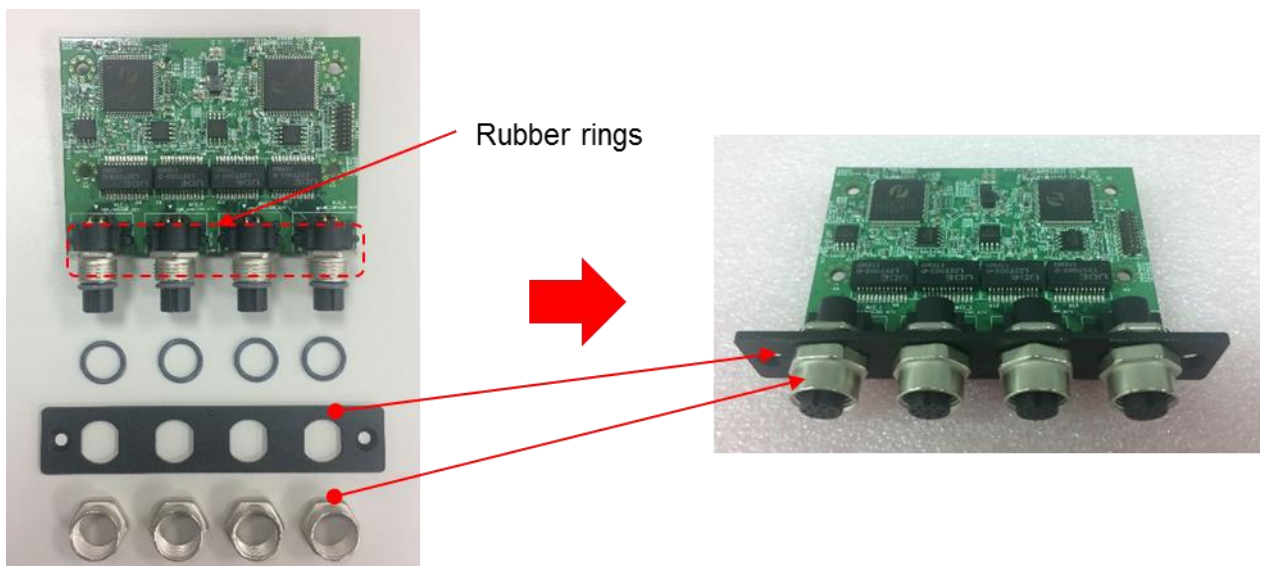

3. Locate the CMI connector on the top side of system.



4. Exchange screw to copper pillar before insert the CMI module.

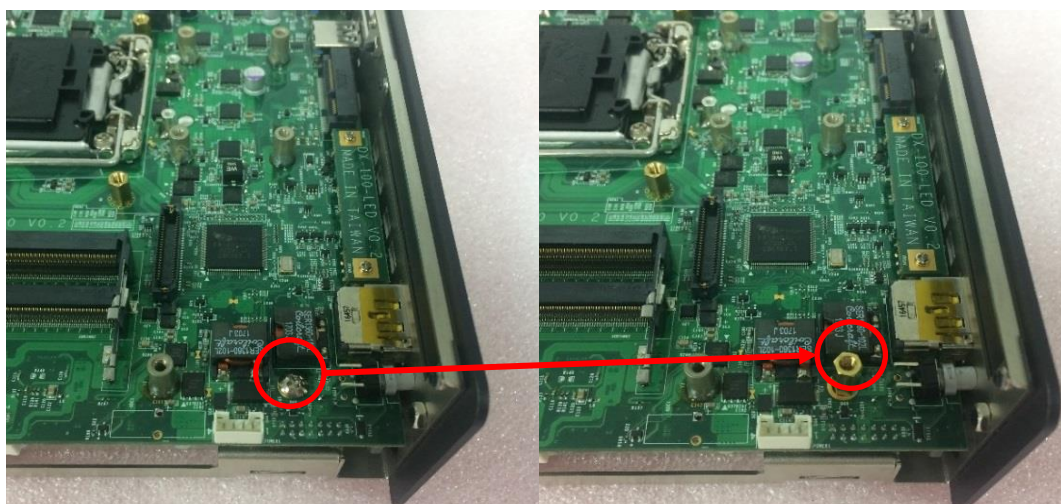

5. Insert the CMI module vertically into the female connector on system's mainboard until it's connected firmly and fasten 4 screws to fix it.

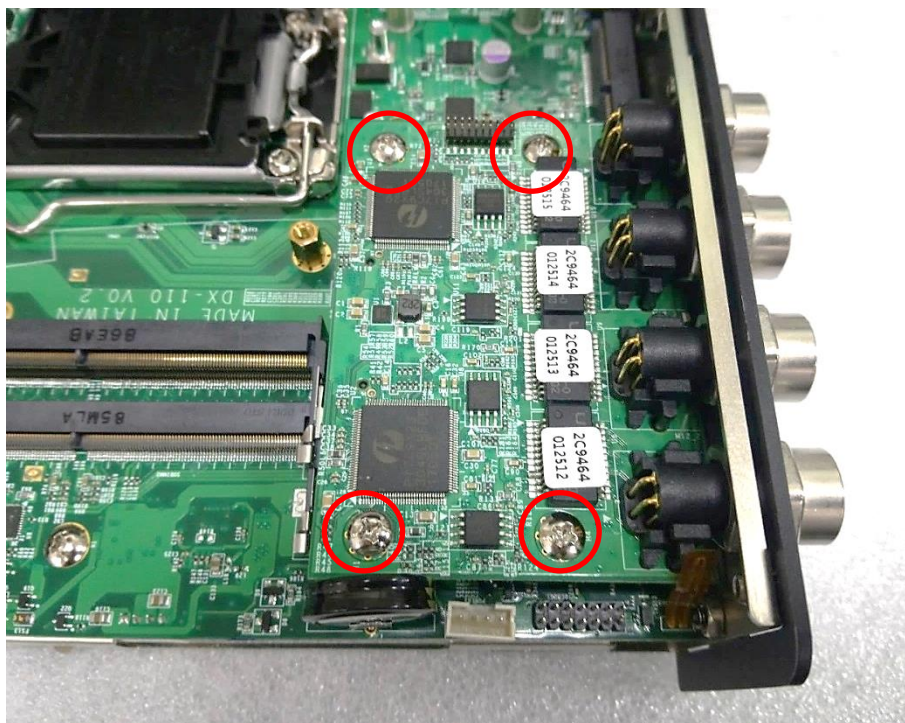

6. Fasten 2 screws on cover plate.



6.6.2 CMI-XM12LAN01-R10/UB0930



1. Assemble the hex rings, M12 I/O bracket and hex washers together as indicated below:
Penetrate hex rings through the M12 I/O bracket holes, and fix them with hex washers.



2. Loosen the 2 screws on front bezel to remove the cover plate.



3. Locate the CMI connector on the top side of system.



4. Exchange screw to copper pillar before insert the CMI module.

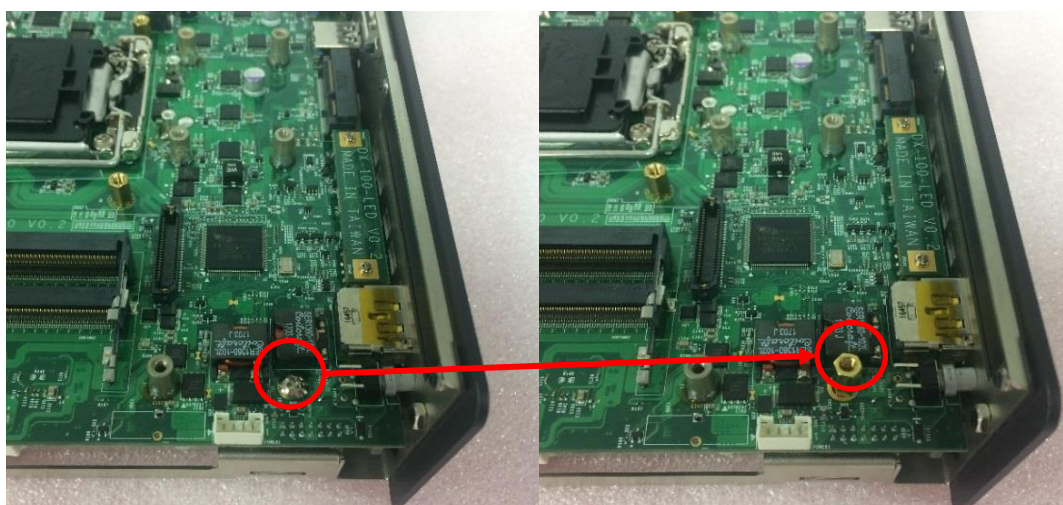

5. Insert the CMI module vertically into the female connector on system's mainboard until it's connected firmly and fasten 4 screws to fix it.

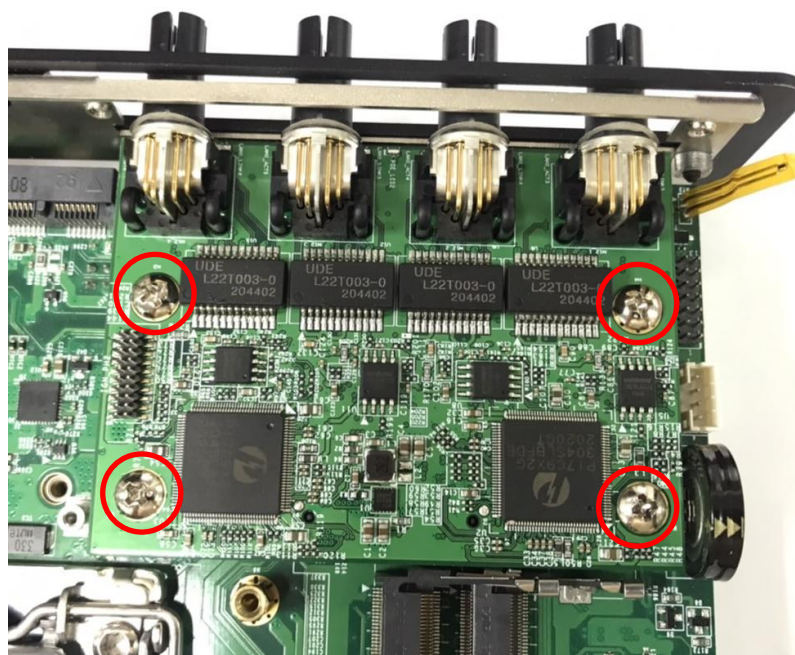

6. Attach the assembled M12 I/O bracket on to the system, and fasten the two screws to fix it.

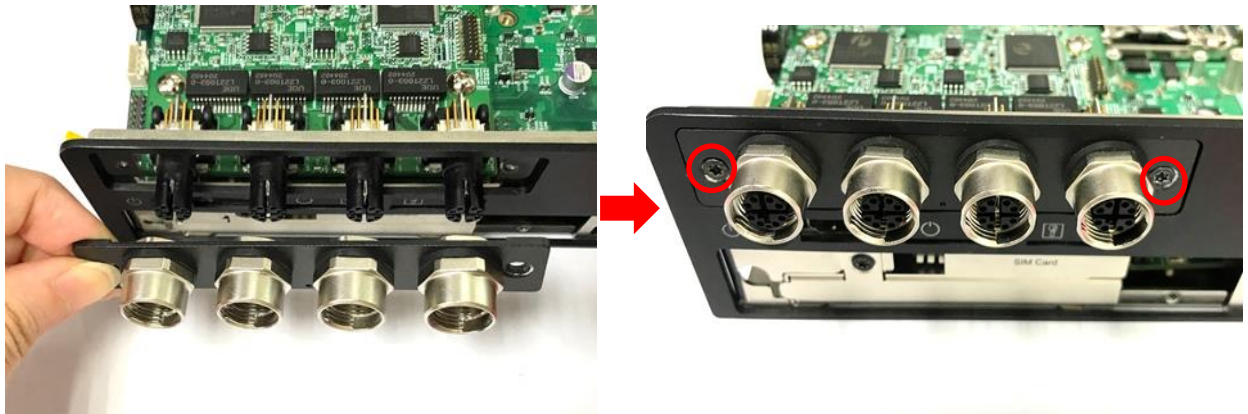

7. Put on the rubber rings to the four M12 LAN ports.

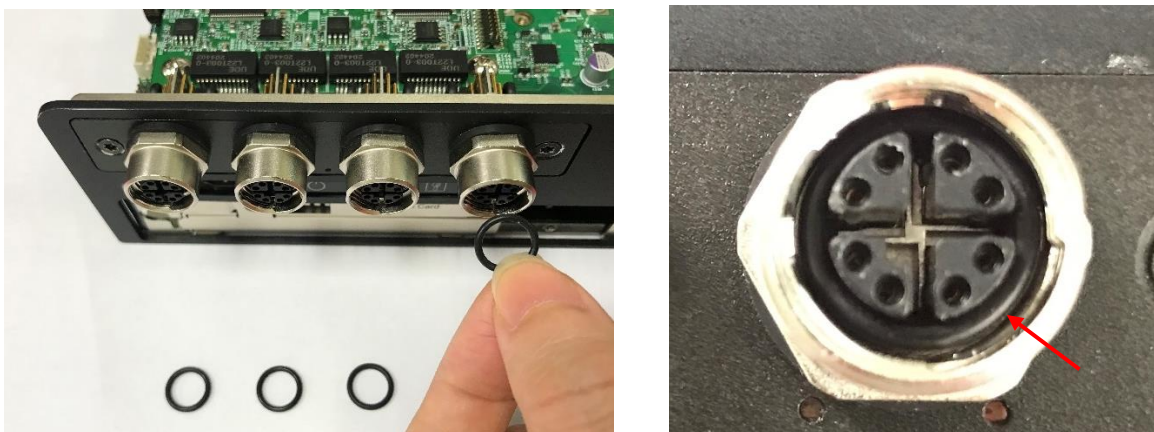

6.7 Installing a CFM-PoE Module

Model No.	Product Description
CFM-PoE01	CFM Module with PoE Control Function, Individual Port 25.5W

1. If you use CMI-LAN module, please paste the shading tape to the place which was marked by red circle. If you use CMI-M12LAN module please skip this step.

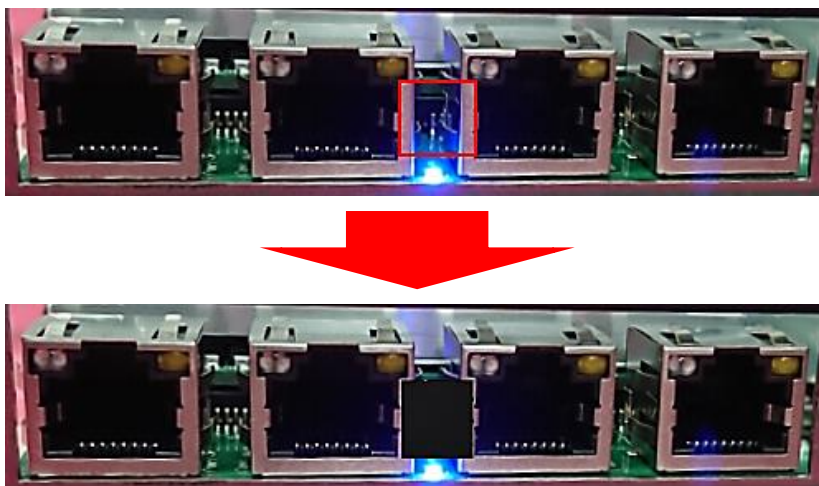

2. Insert the CMI-LAN module for DX-1100 vertically to the female connector (BTB_FH2 or BTB_FH4) on system's mainboard until it is connected firmly, and fasten 4 copper pillars to fix it. (CMI-M12LAN module is taken as the installation example in this chapter)

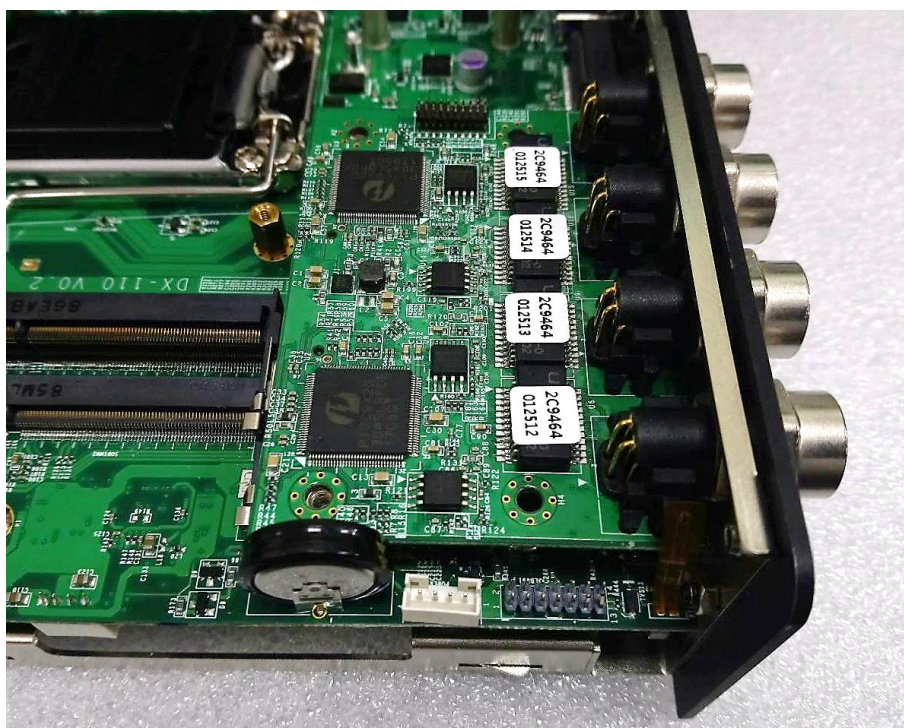

3. Insert the CFM-PoE01 module vertically into the female connector on the CMI module until it's connected firmly.

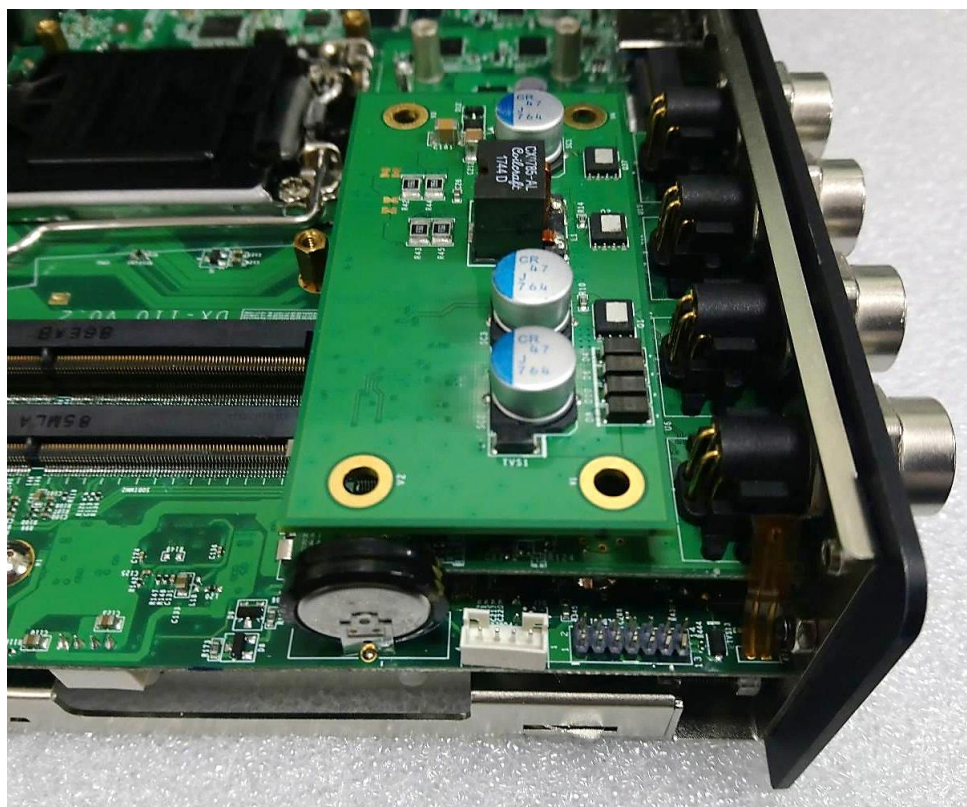

4. Turn over the heatsink of CFM-PoE01 and locate the two places marked by red squares.

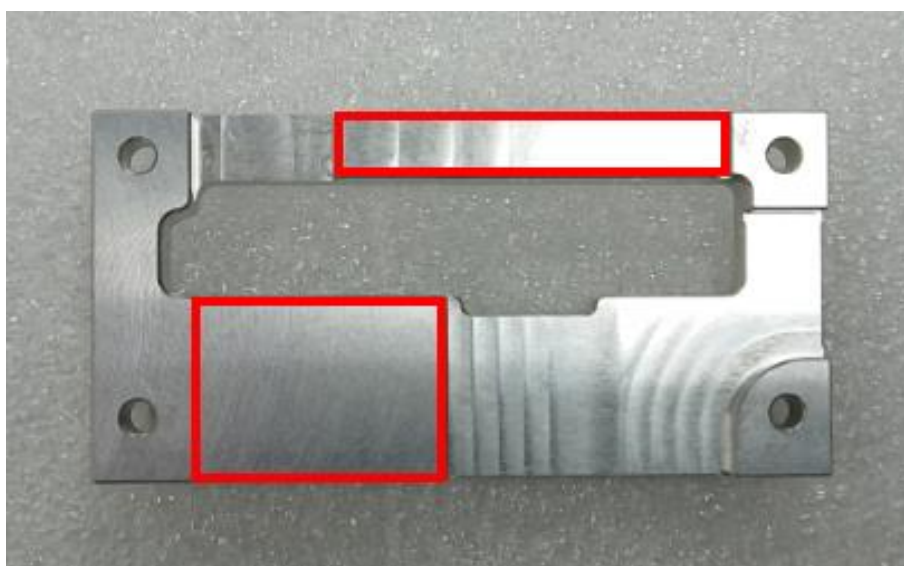

5. Paste two thermal pads for CFM-PoE01 onto the heatsink carefully.

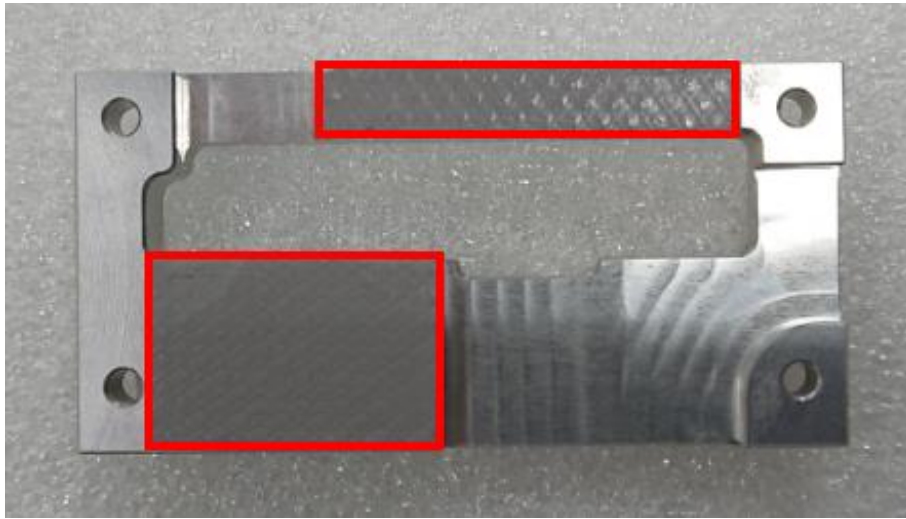

CAUTION

Before putting on the thermal block (in the next step), please make sure the protective films on the Thermal Pads have been removed!

6. Paste the heatsink onto the CMI-PoE module carefully and connect the PoE module to the CMI-M12LAN module.

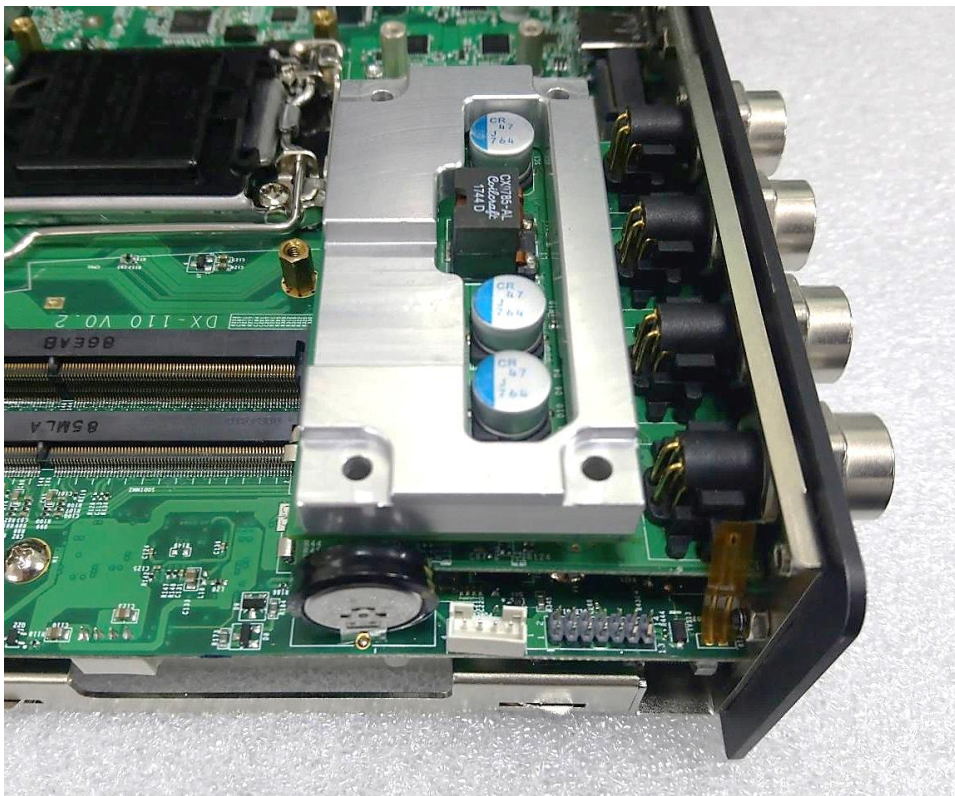

7. Fasten 4 screws to fix it.

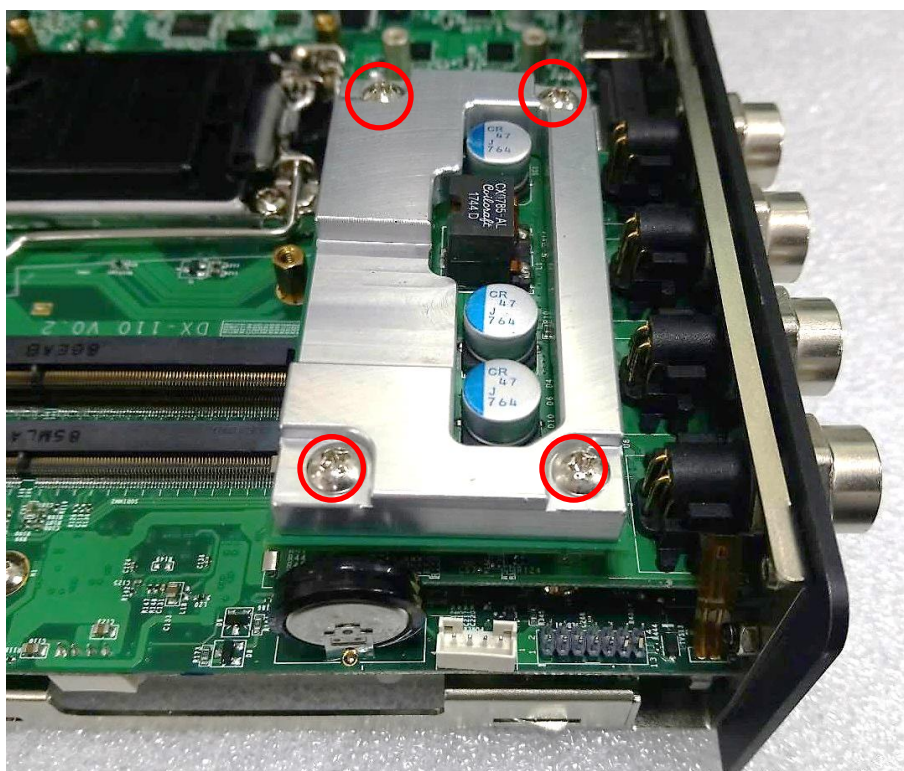

8. Paste the last thermal pad onto the heatsink carefully.



CAUTION

The yellow surface is part of the thermal pad. Do not tear it off as it would affect the thermal conductivity.

6.8 Installing a CFM-IGN Power Ignition Module

1. Locate the IGN connector on the bottom side of system.

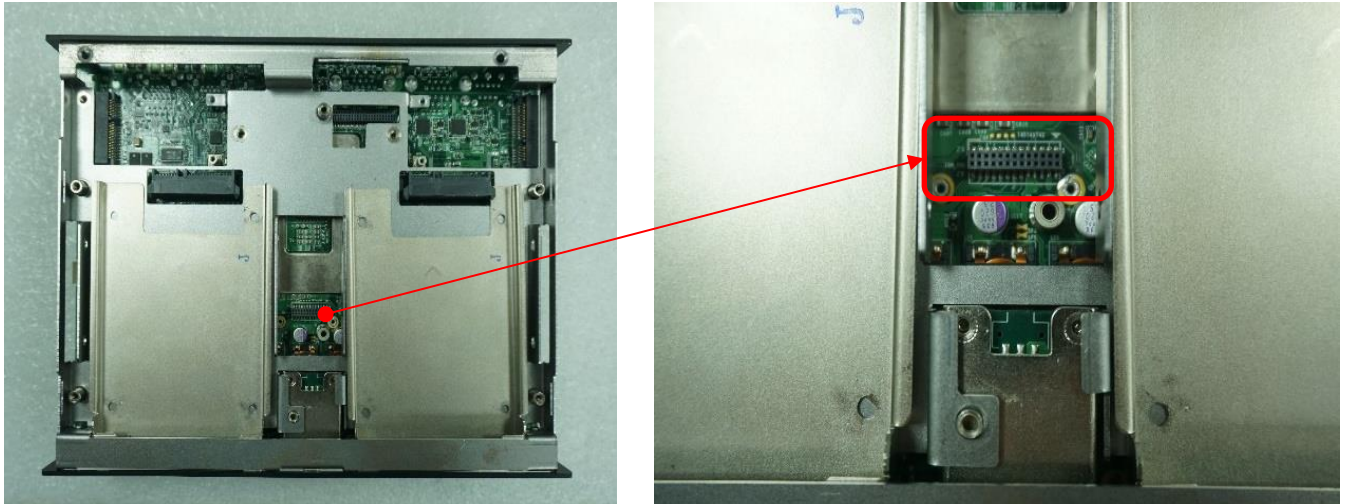

2. Fasten 1 copper pillar before insert IGN module.



3. Insert IGN module vertically to the female connector on the system's mainboard, and fasten 2 screws to fix it.

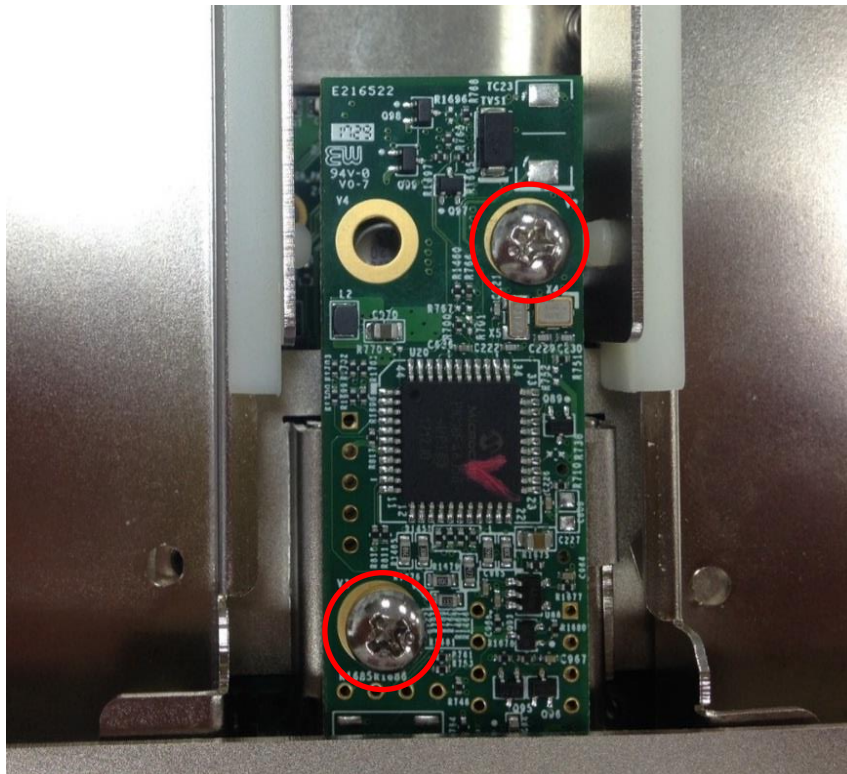

cincoze

© 2020 Cincoze Co., Ltd. All rights reserved.

The Cincoze logo is a registered trademark of Cincoze Co., Ltd.

All other logos appearing in this catalog are the intellectual property of the respective company, product, or organization associated with the logo.

All product specifications and information are subject to change without notice.