

chcoze

GP-3000 Series

User Manual



Embedded GPU Computer

9/8th Gen Intel® Xeon®/Core™ Modular GPU Computer,
Supports Dual Full-length GPU Expansion Up to 500W

Version: V1.05

Contents

Preface	6
Revision.....	6
Copyright Notice	6
Acknowledgement	6
Disclaimer.....	6
Declaration of Conformity	6
Product Warranty Statement.....	7
Technical Support and Assistance	9
Conventions Used in this Manual.....	9
Safety Precautions.....	10
Ordering information	11
Chapter 1 Product Introductions	13
1.1 Overview.....	14
1.2 Highlights	15
1.3 Product Pictures.....	16
1.4 Key Features.....	19
1.5 Hardware Specification	20
1.6 System I/O	23
1.7 Mechanical Dimension	26
Chapter 2 Switches & Connectors	28
2.1 Location of Switches and Connectors	29
2.1.1 Top View.....	29
2.1.2 Bottom View.....	29
2.2 Switches and Connectors Definition	30
2.3 Definition of Switches.....	31
2.4 Definition of Connectors	33
Chapter 3 System Setup.....	40
3.1 Removing Top Cover	41
3.1 Installing CPU	44
3.2 Installing SO-DIMM	46
3.3 Installing Mini-PCle Card.....	47
3.4 Installing M.2 E Key Card.....	48
3.5 Installing M.2 M Key Card	49
3.6 Installing Antenna.....	50
3.6.1 Antenna #1 to #4	50
3.6.2 Antenna #5 to #7	52
3.7 Installing Thermal Pad on MOSFET Heatsink	54

3.8	Installing Top Cover	55
3.9	Installing SATA Hard Drives at Front Panel.....	57
3.10	Installing SIM Card	60
3.11	Installing Rubber Foot Pad.....	61
3.12	Installing Wall Mount.....	62
3.13	Installing Desktop Mount Bracket.....	64
3.14	Installing 19" Rack Mount	66
3.15	Connecting to Power Supply.....	69
Chapter 4 BIOS Setup		70
4.1	BIOS Introduction.....	71
4.2	Main Setup.....	72
4.3	Advanced Setup.....	73
4.3.1	CPU Configuration.....	73
4.3.2	Power & Performance.....	74
4.3.3	SATA Configuration	74
4.3.4	PCH-FW Configuration	75
4.3.5	Trusted Computing	76
4.3.6	ACPI Settings	77
4.3.7	F81866 Super IO Configuration	78
4.3.8	Hardware Monitor	79
4.3.9	S5 RTC Wake Settings	80
4.3.10	Serial Port Console Redirection	80
4.3.11	USB Configuration	81
4.3.12	Network Stack Configuration.....	82
4.3.13	CSM Configuration.....	82
4.3.14	NVMe Configuration.....	84
4.4	Chipset Setup	85
4.4.1	System Agent (SA) Configuration	85
4.4.2	PCH-IO Configuration	87
4.5	Security Setup.....	90
4.5.1	Administrator Password	90
4.5.2	User Password	90
4.5.3	Security Boot	90
4.6	Boot Setup	91
4.6.1	Setup Prompt Timeout [1]	91
4.6.2	Bootup NumLock State [Off]	91
4.6.3	Quiet Boot [Disabled]	91
4.6.4	Fast Boot [Disabled].....	91
4.7	Save & Exit	92

4.7.1 Save Changes and Exit	92
4.7.2 Discard Changes and Exit.....	92
4.7.3 Save Changes and Reset	92
4.7.4 Discard Changes and Reset	92
4.7.5 Save Changes	92
4.7.6 Discard Changes	92
4.7.7 Restore Defaults	92
4.7.8 Save as User Defaults	92
4.7.9 Restore User Defaults.....	92
Chapter 5 Product Application	93
5.1 Digital I/O (DIO) application.....	94
5.1.1 Digital I/O Programming Guide	94
5.2 DIO Hardware Specification	100
5.2.1 DIO Connector Definition	101
5.3 GPIO LED application.....	103
5.3.1 GPIO LED Programming Guide	103
5.4 GPIO LED Status Definition	115
Chapter 6 Optional Modules & Accessories	116
6.1 Optional Module Pin Definition & Settings	117
6.1.1 CMI-M12LAN01-R12/UB1410 Module	117
6.1.2 CMI-XM12LAN01-R10/UB1410 Module.....	117
6.1.3 CMI-COM04-R10/UB1403 Module.....	118
6.1.4 CFM-IGN03-R11 Module	119
6.1.5 GEB-3301-R10 Module.....	120
6.1.6 GEB-3601-R10 Module.....	123
6.2 Installing High Speed CMI Module	127
6.2.1 CMI-LAN01-R12/UB1412 Module	127
6.2.2 CMI-M12LAN01-R12/UB1410 Module	129
6.2.3 CMI-XM12LAN01-R10/UB1410 Module.....	132
6.2.4 CMI-10GLAN02-R10/UB1428 Module	135
6.3 Installing Low Speed CMI Module	139
6.3.1 CMI-DIO04-R11/UB1418 Module	139
6.3.2 CMI-COM04-R10/UB1403 Module.....	142
6.4 Installing CFM Module.....	145
6.4.1 CFM-PoE01 Module	145
6.4.2 CFM-PoE07-R10 Module.....	148
6.4.3 CFM-IGN03-R11 Module	151
6.5 Installing MEC Module	152
6.5.1 MEC-USB-M102-15/UB1414 Module.....	152

6.6	Installing GEB-3301-R10 Module	155
6.6.1	Installing GEB-3301-R10 Module onto GP-3000.....	155
6.6.2	Installing GPU Card	158
6.6.3	Installing Rubber Foot Pad	166
6.6.4	Installing Wall Mount.....	167
6.6.5	Installing 19" Rack Mount	169
6.7	Installing GEB-3601-R10 Module	173
6.7.1	Installing GEB-3601-R10 Module onto GP-3000.....	173
6.7.2	Installing GPU Card	177
6.7.3	Installing Rubber Foot Pad	186
6.7.4	Installing Wall Mount.....	188
6.7.5	Installing 19" Rack Mount	190
6.8	Power Supply Cabling Guide.....	194
6.8.2	Cabling with US Power Cord.....	194
6.8.3	Cabling with EU Power Cord.....	196

Preface

Revision

Revision	Description	Date
1.00	First Release	2021/03/03
1.01	Add safety precaution and update product photos	2021/04/01
1.02	Add 19" Rack Mount installation	2021/05/26
1.03	Correction Made	2021/06/28
1.04	Add CMI-XM12LAN01-R10 installation steps	2021/07/26
1.05	Correction Made	2021/09/11

Copyright Notice

© 2021 by Cincoze Co., Ltd. All rights are reserved. No parts of this manual may be copied, modified, or reproduced in any form or by any means for commercial use without the prior written permission of Cincoze Co., Ltd. All information and specification provided in this manual are for reference only and remain subject to change without prior notice.

Acknowledgement

Cincoze is a registered trademark of Cincoze Co., Ltd. All registered trademarks and product names mentioned herein are used for identification purposes only and may be trademarks and/or registered trademarks of their respective owners.

Disclaimer

This manual is intended to be used as a practical and informative guide only and is subject to change without notice. It does not represent a commitment on the part of Cincoze. This product might include unintentional technical or typographical errors. Changes are periodically made to the information herein to correct such errors, and these changes are incorporated into new editions of the publication.

Declaration of Conformity



FCC

This equipment has been tested and found to comply with the limits for a Class A digital device, pursuant to Part 15 of the FCC Rules. These limits are designed to provide reasonable protection against harmful interference when the equipment is operated in a commercial environment. This equipment generates, uses, and can radiate radio frequency energy and, if not installed and used in accordance with the

instruction manual, may cause harmful interference to radio communications. Operation of this equipment in a residential area is likely to cause harmful interference in which case the user will be required to correct the interference at his own expense.



CE

The product(s) described in this manual complies with all application European Union (CE) directives if it has a CE marking. For computer systems to remain CE compliant, only CE-compliant parts may be used. Maintaining CE compliance also requires proper cable and cabling techniques.



E-Mark

The "E" mark is based on ECE regulations issued by the Economic Commission for Europe. It is an organizational part of the UN and the members are EU countries and many others. Therefore, the acceptance of approved components is much broader, especially in the eastern part of Europe. It is necessary to confirm whether a particular country has accepted (signed) the application of an ECE-regulation; as the application it is not mandatory for the countries.

Product Warranty Statement

Warranty

Cincoze products are warranted by Cincoze Co., Ltd. to be free from defect in materials and workmanship for 2 years from the date of purchase by the original purchaser. During the warranty period, we shall, at our option, either repair or replace any product that proves to be defective under normal operation. Defects, malfunctions, or failures of the warranted product caused by damage resulting from natural disasters (such as by lightning, flood, earthquake, etc.), environmental and atmospheric disturbances, other external forces such as power line disturbances, plugging the board in under power, or incorrect cabling, and damage caused by misuse, abuse, and unauthorized alteration or repair, and the product in question is either software, or an expendable item (such as a fuse, battery, etc.), are not warranted.

RMA

Before sending your product in, you will need to fill in Cincoze RMA Request Form and obtain an RMA number from us. Our staff is available at any time to provide you with the most friendly and immediate service.

■ RMA Instruction

- Customers must fill in Cincoze Return Merchandise Authorization (RMA) Request Form and obtain a RMA number prior to returning a defective product to Cincoze for service.
- Customers must collect all the information about the problems encountered and note anything abnormal and describe the problems on the “Cincoze Service Form” for the RMA number apply process.
- Charges may be incurred for certain repairs. Cincoze will charge for repairs to products whose warranty period has expired. Cincoze will also charge for repairs to products if the damage resulted from acts of God, environmental or atmospheric disturbances, or other external forces through misuse, abuse, or unauthorized alteration or repair. If charges will be incurred for a repair, Cincoze lists all charges, and will wait for customer’s approval before performing the repair.
- Customers agree to ensure the product or assume the risk of loss or damage during transit, to prepay shipping charges, and to use the original shipping container or equivalent.
- Customers can be sent back the faulty products with or without accessories (manuals, cable, etc.) and any components from the system. If the components were suspected as part of the problems, please note clearly which components are included. Otherwise, Cincoze is not responsible for the devices/parts.
- Repaired items will be shipped along with a "Repair Report" detailing the findings and actions taken.

Limitation of Liability

Cincoze’ liability arising out of the manufacture, sale, or supplying of the product and its use, whether based on warranty, contract, negligence, product liability, or otherwise, shall not exceed the original selling price of the product. The remedies provided herein are the customer’s sole and exclusive remedies. In no event shall Cincoze be liable for direct, indirect, special or consequential damages whether based on contract of any other legal theory.

Technical Support and Assistance

1. Visit the Cincoze website at www.cincoze.com where you can find the latest information about the product.
2. Contact your distributor or our technical support team or sales representative for technical support if you need additional assistance. Please have following information ready before you call:
 - Product name and serial number
 - Description of your peripheral attachments
 - Description of your software (operating system, version, application software, etc.)
 - A complete description of the problem
 - The exact wording of any error messages

Conventions Used in this Manual



WARNING

This indication alerts operators to an operation that, if not strictly observed, may result in severe injury.



CAUTION

This indication alerts operators to an operation that, if not strictly observed, may result in safety hazards to personnel or damage to equipment.



NOTE

This indication provides additional information to complete a task easily.

Safety Precautions

Before installing and using this device, please note the following precautions.

1. Read these safety instructions carefully.
2. Keep this User's Manual for future reference.
3. Disconnect this equipment from any AC outlet before cleaning.
4. For plug-in equipment, the power outlet socket must be located near the equipment and must be easily accessible.
5. Keep this equipment away from humidity.
6. Put this equipment on a reliable surface during installation. Dropping it or letting it fall may cause damage.
7. Make sure the voltage of the power source is correct before connecting the equipment to the power outlet.
8. Use a power cord that has been approved for using with the product and that it matches the voltage and current marked on the product's electrical range label. The voltage and current rating of the cord must be greater than the voltage and current rating marked on the product.
9. Position the power cord so that people cannot step on it. Do not place anything over the power cord.
10. All cautions and warnings on the equipment should be noted.
11. If the equipment is not used for a long time, disconnect it from the power source to avoid damage by transient overvoltage.
12. Never pour any liquid into an opening. This may cause fire or electrical shock.
13. Never open the equipment. For safety reasons, the equipment should be opened only by qualified service personnel.

If one of the following situations arises, get the equipment checked by service personnel:

- The power cord or plug is damaged.
 - Liquid has penetrated into the equipment.
 - The equipment has been exposed to moisture.
 - The equipment does not work well, or you cannot get it work according to the user's manual.
 - The equipment has been dropped and damaged.
 - The equipment has obvious signs of breakage.
14. **CAUTION:** Danger of explosion if battery is incorrectly replaced. Replace only with the same or equivalent type recommended by the manufacturer.
 15. Equipment intended only for use in a RESTRICTED ACCESS AREA.
 16. The product cannot be used vertically standing on a desktop or any flat surface without wall mount bracket.

Ordering information

Before installation, please ensure all the items listed in the following table are included in the package. Notify your sales representative if any of the above items are missing or damaged.

GP-3000

Available Models

Model No.	Product Description
GP-3000-R10	9th/8th Gen Intel® Xeon®/Core™ GPU Computer, Supports Dual Full-length GPU Expansion Up to 500W

Package Checklist

Item	Description	Q'ty
1	Wall Mount Bracket	1
2	Desktop Mount Kit	1
3	CPU Heat Sink and Thermal Pad	1
4	Screws Pack	4
5	Rubber Foot Kit	1
6	Power Terminal Block Connector	2
7	Remote Function Terminal Block Connector	2
8	Utility DVD Driver	1

GEB-3301-R10

Available Models

Model No.	Product Description
GEB-3301-R10	GPU Expansion Box with 1 x PCIe x 16 and 1 x PCIe x 4 Slots for GP-3000 Series

Package Checklist

Item	Description	Q'ty
1	Wall Mount Bracket	1
2	8 Pin to 6+2 Pin GPU Power Cable	2
3	Screws Pack	2
4	GPU Card Retainer Screw Pack	1
5	Rubber Foot Kit	1
6	Sponge	2

GEB-3601-R10

Available Models

Model No.	Product Description
GEB-3601-R10	GPU Expansion Box with 2 x PCIe x 16 (Signal PCIe x 8), 1 x PCIe x 4 and 1 x PCIe x 1 Slots for GP-3000 Series

Package Checklist

Item	Description	Q'ty
1	Wall Mount Bracket	1
2	8 Pin to 6+2 Pin GPU Power Cable	4
3	Screws Pack	2
4	GPU Card Retainer Screw Pack	1
5	Rubber Foot Kit	1
6	Sponge	4



Chapter 1

Product Introductions

1.1 Overview

GP-3000. A flagship GPU edge computing computer of Cincoze. Its crowning feature is an exclusive GPU Expansion Box that provides expansion for up to two high-end GPU cards and creating a high-performance industrial-grade GPU computing computer.

Extreme Computing Performance

The GP-3000's extreme computing power starts with an 8th or 9th generation Intel® Xeon® or Core™ i3/i5/i7 (Coffee Lake and Coffee Lake-R) CPU, Intel® C246 chipset, and supports two sets of DDR4-2666 ECC/non-ECC SO-DIMM up to 64 GB and can support up to two 250 W high-end GPU cards. With a total power consumption of 720W, it's easy to meet and exceed high-efficiency application requirements. A precision heat dissipation and cooling design quickly wick away heat, keeping the focus squarely on the breathtaking performance of the GP-3000.

Rich Application Functions

The GP-3000 redefines the standard for high-end GPU computers, with high-speed I/O and multiple functions. In addition to the standard five LAN ports and six USB 3.2 ports, the GP-3000 uses Cincoze's exclusive CMI and CFM modular design, which offers expansion modules with eight Gigabit PoE, two USB 3.2, or dual 10 Gb/s LAN ports. Storage options include high-speed M.2 NVMe storage slots and four hot-swappable 2.5" HDD/SSD trays accessible through the front maintenance panel. Together, they meet large-capacity machine vision storage requirements and improve hard disk accessibility for convenient removal and replacement. The IGN module (power ignition sensing) can monitor the on-board battery voltage and set a delayed shutdown time to avoid damage to the system due to unstable current when starting or turning off the engine. This combination of diverse functions provides the flexibility to meet the requirements of different market applications.

Strong and Durable

In the pursuit of ever-higher standards, the GP-3000 has passed the MIL-STD-810G certification (pending) designed and promulgated by the US Department of Defense to qualify military equipment. The GP-3000 features 9~48 VDC power input, is built for -40 to 70°C temperature operation. The GP-3000 has E-mark and EN50155 (EN50121-3-2 only) certifications, so it is capable of withstanding the rigors of rail and vehicle applications as well as other harsh environments.

1.2 Highlights



Cutting-Edge Performance

The GP-3000 is powered by the excellent performance of 8th / 9th generation Intel® Xeon® / Core™ processors. Supports two DDR4 SO-DIMM ECC/Non-ECC memory, up to 64GB. Through the exclusive GPU Expansion Box (GEB) design can flexibly expand up to dual high-end GPU cards. And GP-3000 offers 720W system power budget for high-end GPU Computing applications.

Futureproof Scalability

Upgrades are now easy. In addition to GPU expansion through the GEBs, the GP-3000 also retains flexibility for future upgrades. Whether adding or upgrading GPU cards, the core system remains, and only the GBE is changed. Upgrades become easier, and the expansion possibilities become almost endless.

Mount Anywhere

The GP-3000 supports multiple mounting options for various environment. Mounting options include a wall mount, desktop mount, Face-up mount, and 19" rack mount. Simple.

1.3 Product Pictures

GP-3000



GP-3000/GEB-3301



GP-3000/GEB-3601

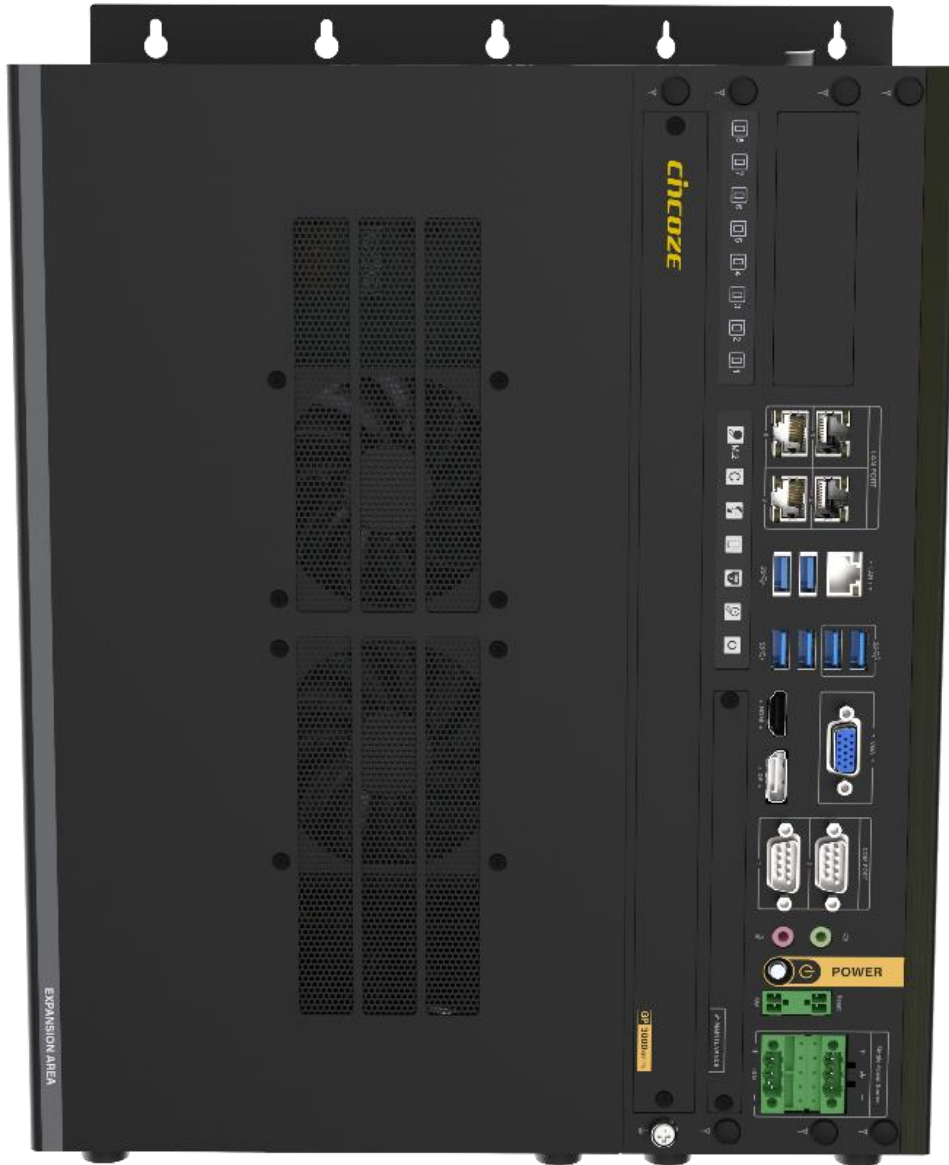

1.4 Key Features

GP-3000

- Supports 9th/8th Gen Intel® Xeon®/Core™ Processor (35W / 65W / 80W)
- 2 x DDR4 SO-DIMM Sockets, Supports ECC/non ECC type up to 2666 MHz, 64GB
- 4 x 2.5" Hot Swappable SATA III HDD/SSD Bays (Max Height 15 mm)
- 1 x M.2 M Key Socket (NVMe), 1 x M.2 E Key Socket (CNVi)
- 2 x Front Accessible SIM Card Slots for Signal Redundancy
- CMI Technology for Various I/O Module Expansions
- CFM Technology for Power Ignition Sensing & PoE Function
- Versatile Mounting Methods (Wall / Stand / Face-up / 19" Rack Mount)
- Military Standard Shock & Vibration Proof (pending)

GEB-3301

- Supports NVIDIA RTX 30 Series GPU Card
- Support 1 x PCIe x16 Slot for full-length GPU card Expansion
- Support 1 x PCIe x4 Slot for Add-on card Expansion
- Intelligent Cooling Design for High Performance GPU Card
- Military Standard Shock & Vibration Proof (pending)

GEB-3601

- Supports NVIDIA RTX 30 Series GPU Card
- Supports 2 x PCIe x16 Slots for full-length GPU cards Expansion
- Supports 1 x PCIe x4 Slot and 1 x PCIe x1 slot for Add-on cards
- Intelligent Cooling Design for High Performance GPU Card
- Military Standard Shock & Vibration Proof (pending)

1.5 Hardware Specification

GP-3000

Processor

- 9th Generation Intel® Coffee Lake-R S Series CPU:
 - Intel® Xeon® E-2278GE 8 Cores Up to 4.7 GHz, TDP 80W
 - Intel® Xeon® E-2278GEL 8 Cores Up to 3.9 GHz, TDP 35W
 - Intel® Core™ i7-9700E 8 Cores Up to 4.4 GHz, TDP 65W
 - Intel® Core™ i5-9500E 6 Cores Up to 4.2 GHz, TDP 65W
 - Intel® Core™ i3-9100E 4 Cores Up to 3.7 GHz, TDP 65W
 - Intel® Core™ i7-9700TE 8 Cores Up to 3.8 GHz, TDP 35W
 - Intel® Core™ i5-9500TE 6 Cores Up to 3.6 GHz, TDP 35W
 - Intel® Core™ i3-9100TE 4 Cores Up to 3.2 GHz, TDP 35W
- 8th Generation Intel® Coffee Lake CPU:
 - Intel® Xeon® E-2176G 6 Cores up to 4.7 GHz, TDP 80W
 - Intel® Xeon® E-2124G 4 Cores up to 4.5 GHz, TDP 71W
 - Intel® Core™ i7-8700 6 Cores up to 4.6 GHz, TDP 65W
 - Intel® Core™ i5-8500 6 Cores, up to 4.1 GHz, TDP 65W
 - Intel® Core™ i3-8100 4 Cores 3.6 GHz, TDP 65W
 - Intel® Core™ i7-8700T 6 Cores up to 4.0 GHz, TDP 35W
 - Intel® Core™ i5-8500T 6 Cores up to 3.5 GHz, TDP 35W
 - Intel® Core™ i3-8100T 4 Cores 3.1 GHz, TDP 35W
 - Intel® Pentium® G5400 2 Cores 3.7 GHz, TDP 58W
 - Intel® Pentium® G5400T 2 Cores 3.1 GHz, TDP 35W
 - Intel® Celeron® G4900 2 Cores 3.1 GHz, TDP 54W
 - Intel® Celeron® G4900T 2 Cores 2.9 GHz, TDP 35W

Chipset

- Intel® C246

BIOS

- AMI BIOS

Memory

- 2x DDR4-2666/2400 MHz SO-DIMM Socket
- Support ECC / non-ECC Type Up to 64 GB
 - * Xeon/i7/i5: Up to DDR4 2666MHz
 - * i3/Pentium/Celeron: Up to DDR4 2400 MHz

Graphics

- Integrated Intel® UHD Graphics
(Xeon/i7/i5/i3: UHD 630; Pentium/Celeron: UHD 610)
- Supports Triple Independent Display (VGA/DisplayPort/HDMI)

Audio

- Realtek® ALC888, High Definition Audio

I/O Interface

- 1x HDMI Connector (4096 x 2160 @ 30Hz)
- 1x DisplayPort Connector (4096 x 2340 @ 60Hz)
- 1x VGA Connector (1920 x 1200 @30Hz)
- 5x GbE LAN, RJ45
 - GbE1: Intel® I219-LM
 - GbE2: Intel® I210
 - GbE3: Intel® I210
 - GbE4: Intel® I210
 - GbE5: Intel® I210
- 2x RS-232/422/485 with Auto Flow Control (Support 5V/12V), DB9

- 2x 10Gbps USB3.2 Gen2 Ports, Type-A
- 4x 5Gbps USB3.2 Gen1 Ports, Type-A
- 1x Line-out & 1x Mic-in, Phone Jack 3.5mm
- 1x ATX Power On/Off Button
- 1x Remote Power On/Off, 2-pin Terminal Block
- 1x Remote Reset, 2-pin Terminal Block
- 1x AT/ATX Mode Switch
- 1x Reset Button
- 1x Clear CMOS Switch

Storage

- 4x 2.5" Front Accessible SATA HDD/SSD Bay (SATA 3.0), Supports up to 15mm in Height
- 1x M.2 Key M 2280 Socket, Supports PCIe x4 NVMe SSD or SATA SSD (GEN3)
- Supports RAID 0/ 1/ 5/ 10

Expansion

- PCIe
 - Optional GPU Expansion Box
 - 1 x PCIe x 4 + 1 x PCIe x 16
 - 2 x PCIe x 16 (8 Lanes) + 1 x PCIe x 1 + 1 x PCIe x 4
- 2x Full-size Mini-PCIe Socket
- 1x M.2 Key E 2230 Socket, Supports Intel CNVi Module
- 1x M.2 Key M 2280 Socket, Support NVMe/SATA SSD
- 1x Universal Bracket
- 2x SIM Sockets
- 7x Antenna Holes

Cincoze Modular Technology

- CMI Interface
 - 1 x High Speed CMI (Combined Multiple I/O) Interface
 - 1 x Low Speed CMI (Combined Multiple I/O) Interface
- CMI Module
 - Optional Modules:
 - 4x GbE LAN, RJ45
 - 4x GbE LAN, M12 A-Coded
 - 4x GbE LAN, M12 X-Coded
 - 2x 10GbE LAN, RJ45
 - 2x RS-232/422/485 with Auto Flow Control (Supports 5V/12V), DB9
 - 16x Optical Isolated DIO (8DI, 8DO), 2x 10 Pin Terminal Block
- CFM Interface
 - 1x CFM (Control Function Module) IGN Interface
 - 1x CFM (Control Function Module) PoE Interface
- CFM Module
 - Optional Module
 - 1x Power Ignition Sensing Module with Delay Time Management and Selectable 12V/24V
 - 1x PoE Function Module Supports Up to 4x PoE+ with Individual port 25.5W
- MEC Module
 - Optional Modules:
 - 2x 5Gbps USB 3.2 Gen1, Type A
 - 2x GbE LAN, RJ45

Other Function

- 2x Fan Kits (Air-flow isolated from the electronics)
- Support 0.2 sec Instant Reboot Technology
- SuperCap Integrated for CMOS Battery Maintenance-free Operation
- Watchdog Timer: Software Programmable Supports 256 Levels System Reset

Power Requirement

- Supports AT/ATX Power Type
- Power Input Voltage: 9-48 VDC, Single Power Source
- Total Power Budget: 220W
- Connector Type: 2x 3-pin Terminal Block, Each Terminal Block Current Limitation is 15A
- Power Supply:
 - Optional AC/DC or DC/DC 24V 480W Power Supply
 - Optional AC/DC or DC/DC 24V 960W Power Supply

Physical

- Dimension (WxDxH): 105 x 195 x 370 mm
- Weight: 8 kg
- Extruded Aluminum with Heavy Duty Metal
- Wall Mount /Desktop Mount /19" Rack Mount / Face-up Mount
- Unibody Chassis
- Jumper-less Design

Protection

- Reverse Power Input Protection
- Over Voltage Protection
 - Protection Range: 51~58V
 - Protection Type: shut down operating voltage, re-power on at the present level to recover
- Over Current Protection: 30A
- ESD Protection: +/-8kV (air), +/-4kV (contact)
- Surge Protection: 3.84kV (impedance 12 ohm 1.2/50µs waveform)

Operating System

- Windows® 10
- Linux: Supports by project

Environment

- Operating Temperature:

CPU \ GPU	GPU	Non-GPU	1 x 250W GPU	1 x 350W GPU	2 x 250W GPU
35W		-40°C to 70°C	-40°C to 40°C	-40°C to 35°C	-40°C to 35°C
65W		-40°C to 60°C	-40°C to 40°C	-40°C to 35°C	-40°C to 35°C
80W		-40°C to 50°C	-40°C to 40°C	-40°C to 35°C	-40°C to 35°C

* With extended temperature peripherals; Ambient with air flow

* According to IEC60068-2-1, IEC60068-2-2, IEC60068-2-14

* 100% CPU and GPU without thermal throttling

- Storage Temperature: -40°C to 85°C
- Relative Humidity: 95% RH @ 70°C (Non-condensing)
- Shock: MIL-STD-810G (pending)
- Vibration: MIL-STD-810G (pending)
- EMC: CE, FCC, ICES-003 Class A, EN50121-3-2 (Railway), E-mark
- Safety: LVD (EN62368-1)
- MTBF: 441,283 hr

** Product Specifications and features are for reference only and are subject to change without prior notice. For more information, please refer to the latest product datasheet from Cincoze's website.*

GEB-3301

Expansion Slot	1x PCIe x16 Slot for GPU Card 1x PCIe x4 Slot
GPU Card Dimension	<ul style="list-style-type: none">• Card Length: 328mm• Card Height: 64mm (Standard Triple-Deck)• Card Width: 134mm
Internal USB	<ul style="list-style-type: none">• 1x USB2.0, Type A
Internal Power Connector	<ul style="list-style-type: none">• 2x 8-Pin Connector for GPU Card
Total Power Budget	<ul style="list-style-type: none">• 350W
Weight Information	<ul style="list-style-type: none">• 3.2 kg
Dimension (W x D x H)	<ul style="list-style-type: none">• 104 x 195 x 360 mm
MTBF	<ul style="list-style-type: none">• 2,713,254 hr

GEB-3601

Expansion Slot	<ul style="list-style-type: none">• 2x PCIe x16 Slot (PCIe x8 Signal) for GPU Card• 1x PCIe x4 Slot• 1x PCIe x1 Slot
GPU Card Dimension	<ul style="list-style-type: none">• Card Length: 328mm• Card Height: 64mm (Standard Triple-Deck)• Card Width: 134mm
Internal USB	<ul style="list-style-type: none">• 1x USB2.0, Type A
Internal Power Connector	<ul style="list-style-type: none">• 4x 8-Pin Connector for GPU Card
Total Power Budget	<ul style="list-style-type: none">• 500W
Weight Information	<ul style="list-style-type: none">• 5.2 kg
Dimension (W x D x H)	<ul style="list-style-type: none">• 200 x 195 x 360 mm
MTBF	<ul style="list-style-type: none">• 1,661,177 hr

1.6 System I/O

CMI I/O Bracket

Used to customized CMI I/O output with optional modules

LAN

Used to connect to local area network

USB3.2 Gen1

Used to connect to USB 3.2 Gen1/2.0/1.1 compatible devices

USB3.2 Gen2

Used to connect to USB 3.2 Gen2/3.2 Gen1/2.0/1.1 compatible devices

HDMI Port

Used to connect the system with HDMI monitor

VGA Port

Used to connect the system with VGA monitor

Display Port

Used to connect a monitor with DisplayPort interface

COM Port

Used to connect to RS-232/422/485 serial devices

Line-Out

Used to connect a speaker

Mic-In

Used to connect a microphone

ATX Power On/Off

Used to power-on or power-off the system

Remote Power On/Off

A terminal block used to connect to remote power on/off switch

Remote Reset

A terminal block used to connect to remote reset switch

DC IN

Used to plug a DC power input with terminal block

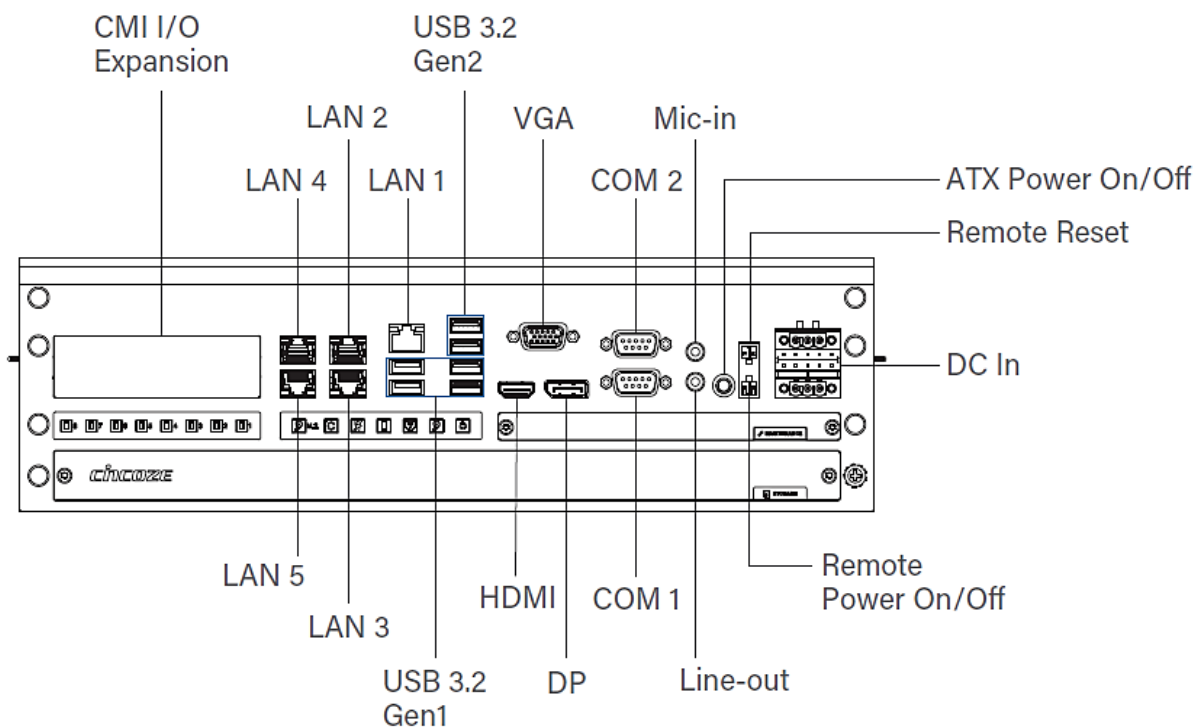

Antenna Hole

Used to connect antenna for optional wireless module

2.5" Hot Swap HDD/SSD Bay

Used to insert 2.5" SATA HDD/SSD

Clear CMOS Battery

Used to insert CMOS battery

IGN Setting Switch

Used to set up IGN function

SIM Card Slot

Used to insert SIM card

Reset Button

Used to reset the system

AT/ATX Mode Switch

Used to select AT or ATX power mode

Clear CMOS

Used to clear CMOS for BIOS reset

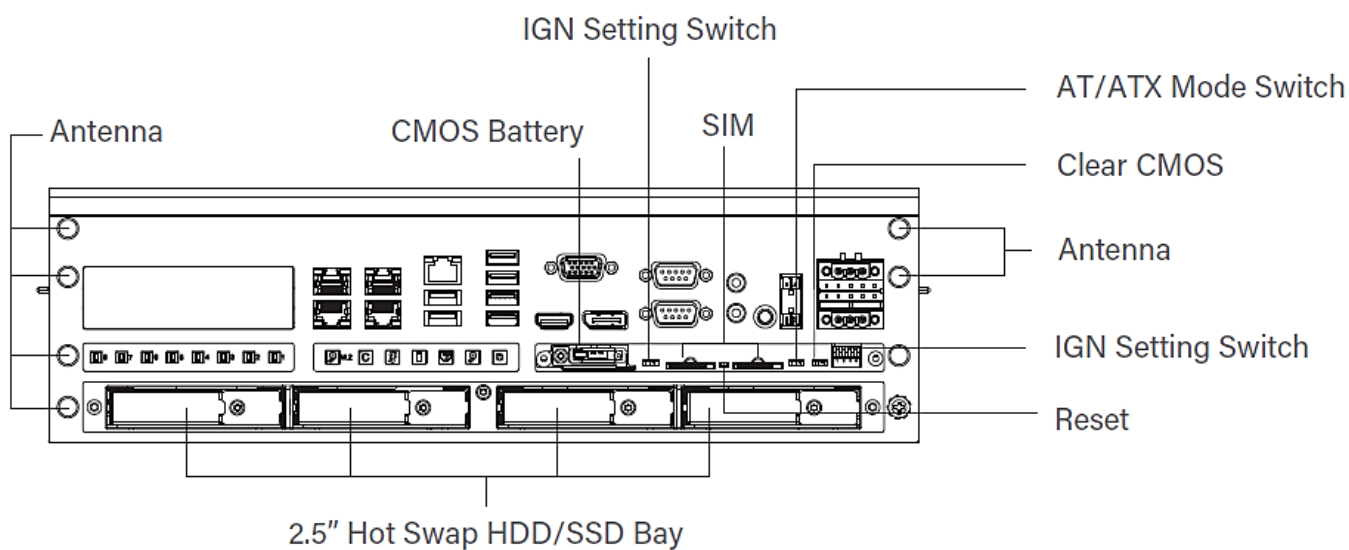

External Fan

Used to be system's external fan

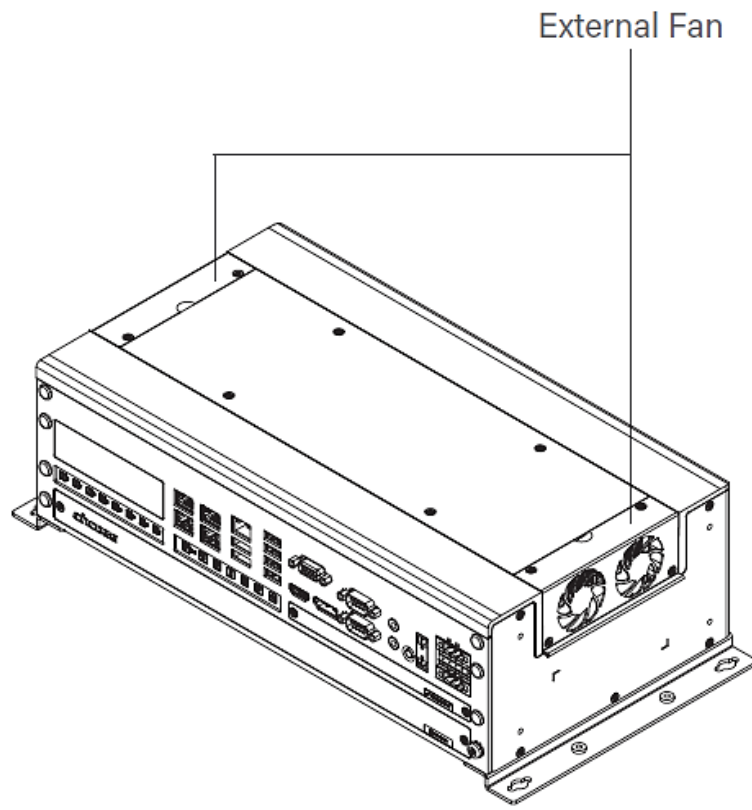

1.7 Mechanical Dimension

GP-3000

Unit: mm

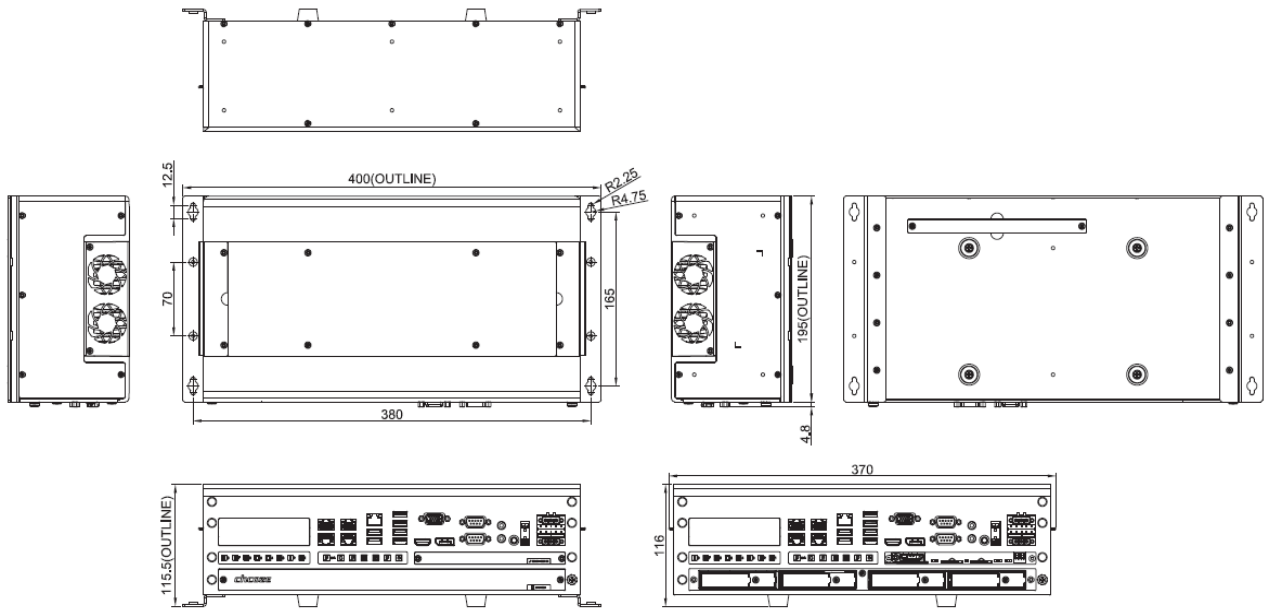

GEB-3301

Unit: mm

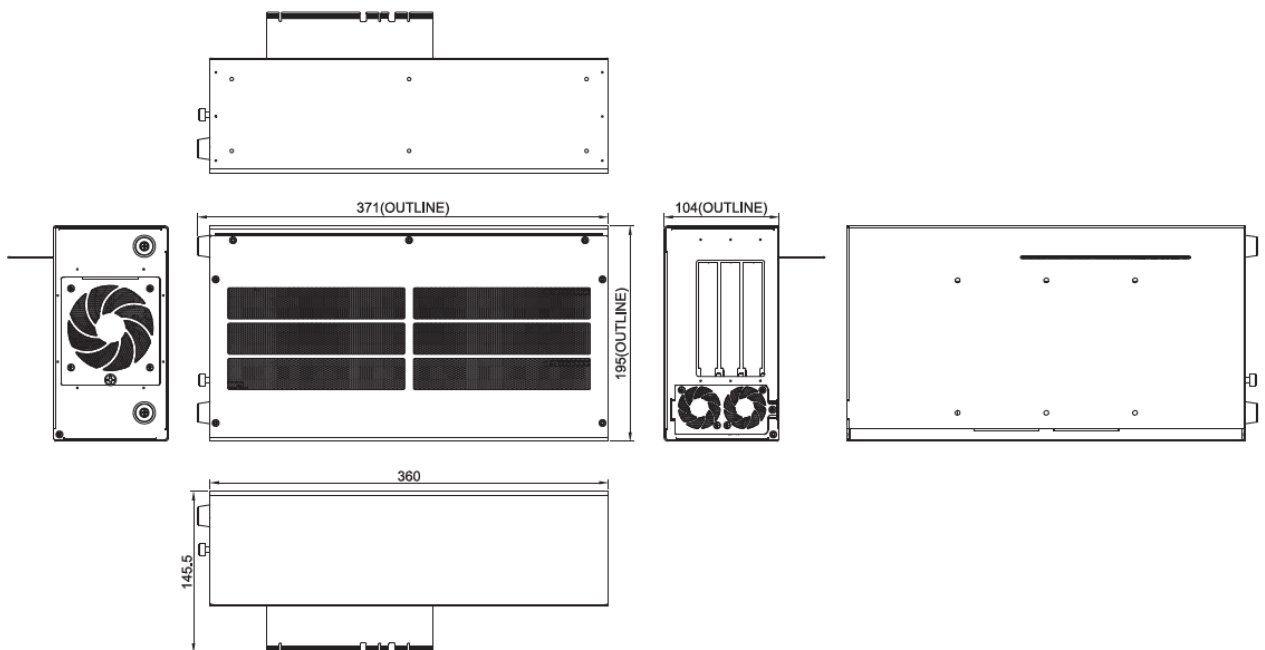

GEB-3601

Unit: mm

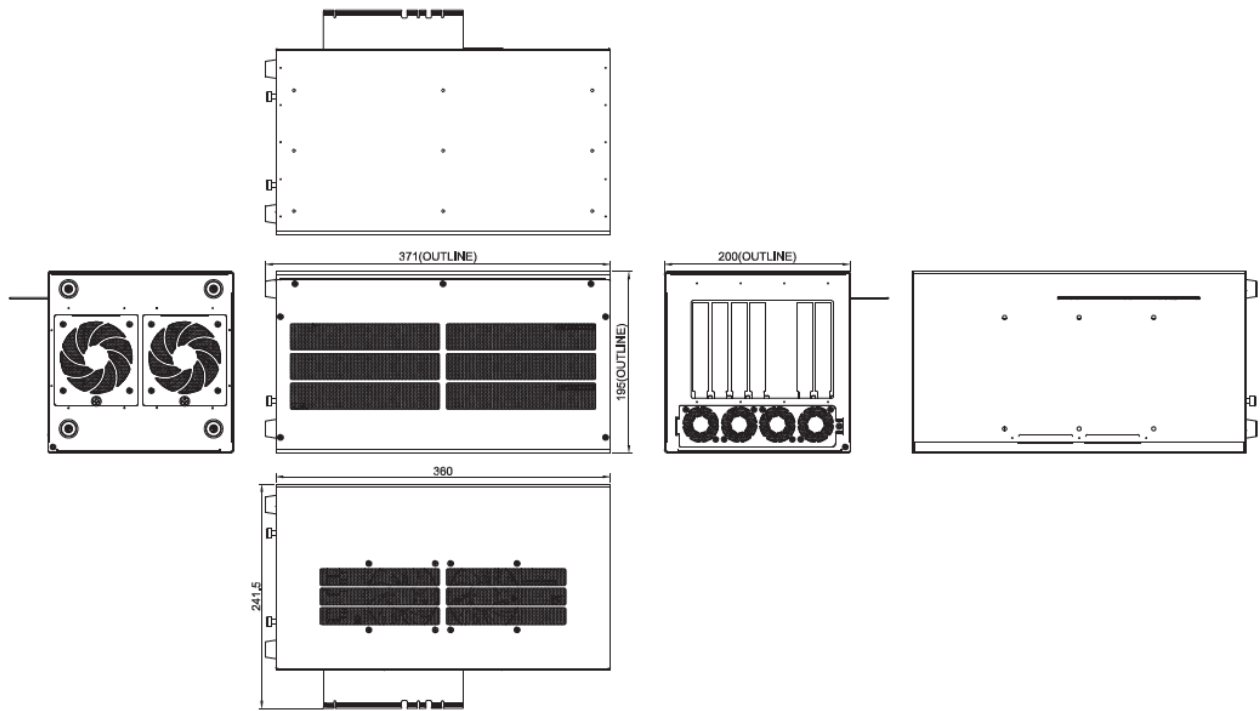



Chapter 2

Switches & Connectors

2.1 Location of Switches and Connectors

2.1.1 Top View

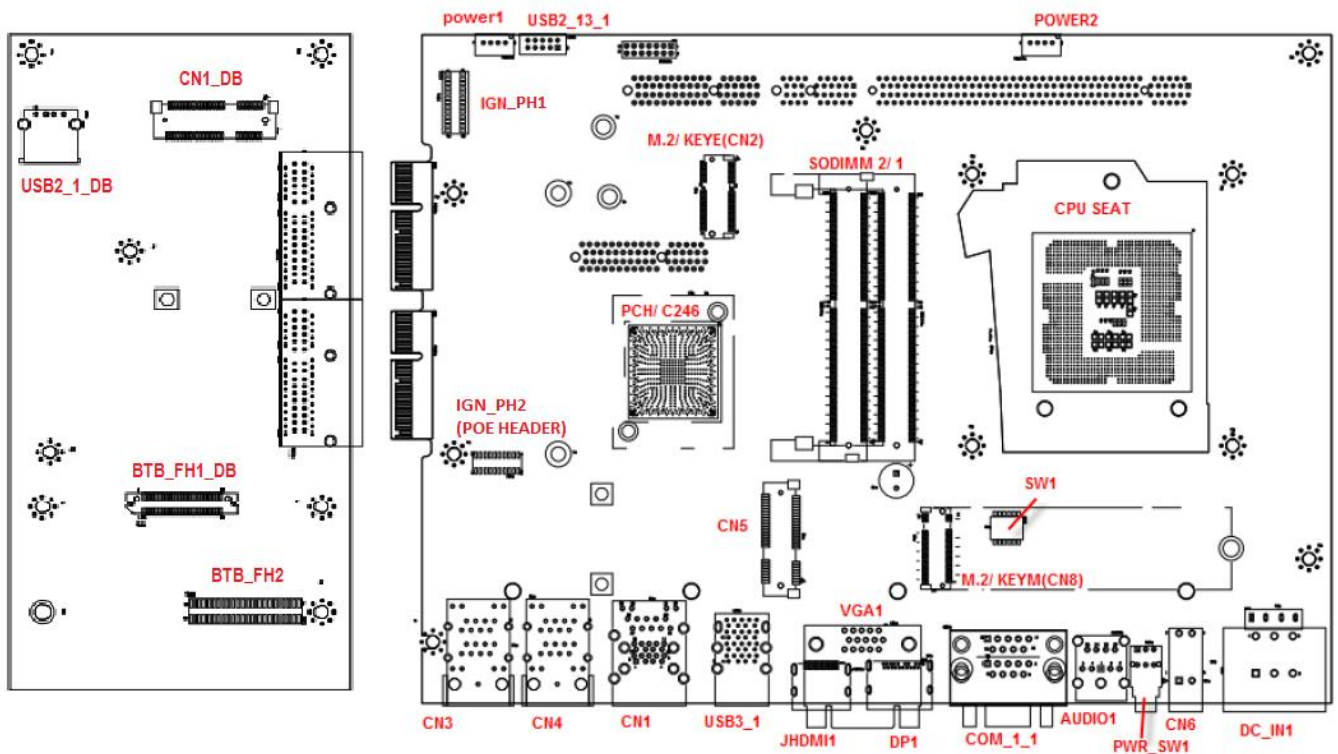

2.1.2 Bottom View

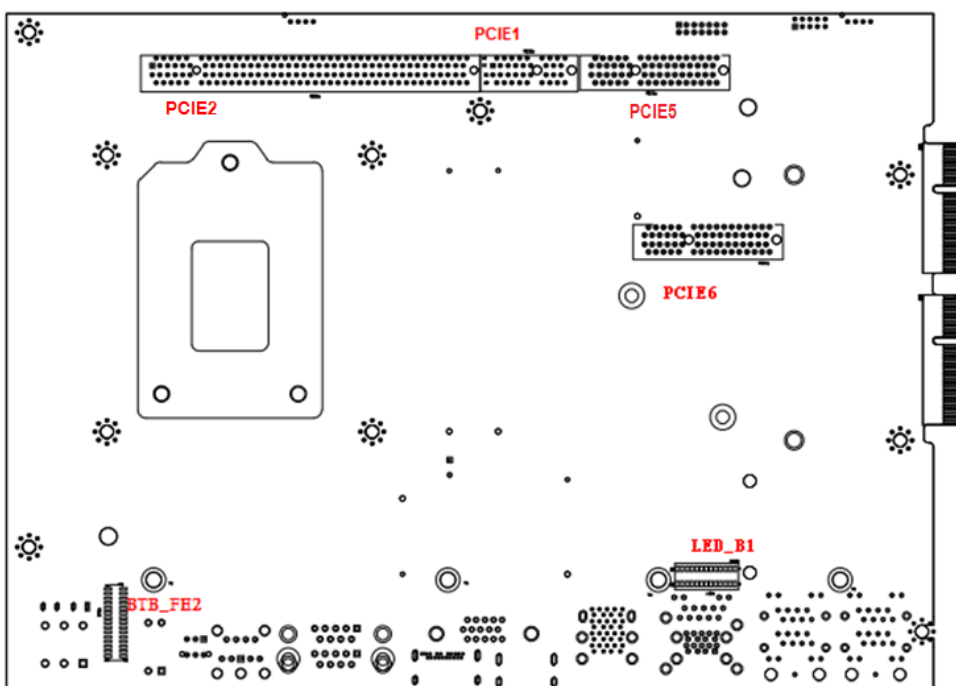

2.2 Switches and Connectors Definition

List of Switch

Location	Definition
AT_ATX_1	AT/ATX Power Mode Switch
CLR_CMOS1_1	Clear COMS Switch
PWR_SW1	Power Button
Reset1_1	Reset Switch
SW1	Super CAP SW and COM1~2 with Power Select

List of Connector

Location	Definition
AUDIO1	2 IN 1 Audio Phone Jack for Headphone line out & MIC phone in
BTB_FH1_DB	PSE LAN Port Board to Board Connector
BTB_FH2	CMI-DIO and CMI-COM (COM3/4) Board to Board Connector
CN1	Giga LAN connector (LAN5) + USB3.2 Gen1 Port x2
CN1_DB	Mini PCI-Express Socket (Support mPCIe / USB3 Interface)
CN2	M.2 Key E socket (Support PCIe / CNVi Interface)
CN3	Giga LAN connector x 2 (LAN3, LAN4)
CN4	Giga LAN connector x 2 (LAN1, LAN2)
CN5	Mini PCI-Express Socket (Support mPCIe / USB3 / SIM Module)
CN6	PWR and Reset remote connector
CN8	M.2 Key M Socket (Support NVMe PCIe / SATA Storage)
COM1_1	RS232 / RS422 / RS485 Connector x2 (COM1/2)
DC_IN1	3 PINs x2 DC 9-48V power input with power ignition connector
DP1	Display Port connector
IGN_PH1	IGN control board connector
IGN_PH2 (POE Header)	PSE Board to Board Connector
JHDMI1	HDMI connector
LED_B1	LED board connector for NVMe HDD / IGN Thermal / IGN Power / GPIO / PoE Function / SATA HDD / System Power LED
POWER1, POWER2	+5V/+12V power output connector
SODIMM1, SODIMM2	DDR4 SO-DIMM
USB2_1_DB	Internal USB 2.0 Ports
USB2_13_1	Internal USB 2.0 Ports
USB3_1	USB3.2 Gen2 Port x2 / USB3.2 Gen1 Port x2
VGA1	VGA connector

2.3 Definition of Switches

AT_ATX_1 : AT / ATX Power Mode Switch

Switch	Definition
Left	AT Power Mode
Right	ATX Power Mode (Default)



CLR_CMOS1_1 : Clear CMOS Switch

Switch	Definition
Left	Clear CMOS
Right	Normal (Default)

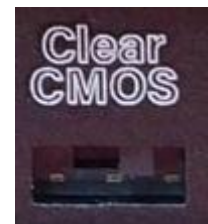

PWR_SW1 : Power Button

Switch	Definition
Push	Power System



RESET1_1 : Reset Switch

Switch	Definition
Push	Reset System



SW1 : Super CAP SW and COM1~2 with Power Select

Location	Function		DIP1	DIP2
SW1	Super Cap	Enabled	ON (Default)	ON (Default)
		Disabled	OFF	

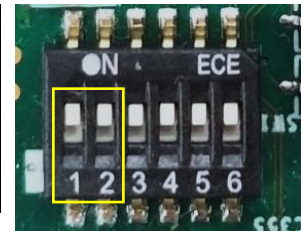

ON
OFF

Location	Function		DIP3	DIP4
SW1	COM1	0V (RI)	ON (Default)	ON (Default)
		5V	ON	OFF
		12V	OFF	OFF

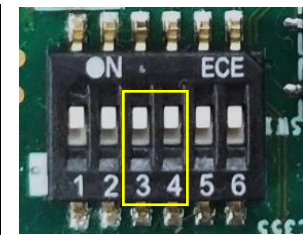

ON
OFF

Location	Function		DIP5	DIP6
SW1	COM2	0V (RI)	ON (Default)	ON (Default)
		5V	ON	OFF
		12V	OFF	OFF

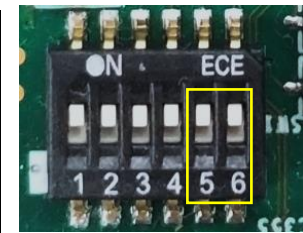

ON
OFF

2.4 Definition of Connectors

CN1_DB : Mini PCI-Express Socket (Support mPCIe / USB3 Interface)

PIN	Definition	PIN	Definition
1	WAKE#	27	GND
2	3.3V	28	+1.5V
3	RESERVED	29	GND
4	GND	30	SMB_CLK
5	RESERVED	31	PETN0
6	1.5V	32	SMB_DATA
7	CLKREQ#	33	PETP0
8	RESERVED	34	GND
9	GND	35	GND
10	RESERVED	36	USB_D-
11	REFCLK-	37	RESERVED
12	RESERVED	38	USB_D+
13	REFCLK+	39	RESERVED
14	RESERVED	40	GND
15	GND	41	RESERVED
16	RESERVED	42	LED_WWAN#
17	RESERVED	43	RESERVED
18	GND	44	LED_WLAN#
19	RESERVED	45	RESERVED
20	RESERVED	46	LED_WPAN#
21	GND	47	RESERVED
22	PERST#	48	+1.5V
23	PERN0	49	RESERVED
24	+3.3VAUX	50	GND
25	PERP0	51	RESERVED
26	GND	52	+3.3V

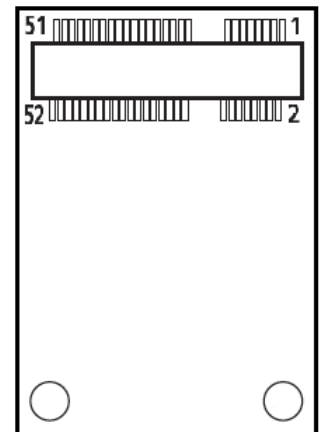

CN2 : M.2 Key E socket (Support PCIe / CNVi Interface)

Pin	Definition	Pin	Definition	Pin	Definition
1	GND	27	KEY	53	NC
2	+3.3V	28	KEY	54	PULL-UP
3	USB_D+	29	KEY	55	PEWAKE0#
4	+3.3V	30	KEY	56	NC
5	USB_D-	31	KEY	57	GND
6	NC	32	RGI_DT	58	I2C_DATA
7	GND	33	GND	59	WTD1N/PETP1
8	PCM_CLK	34	RGI_RSP	60	I2C_CLK
9	WGR_D1N	35	PETP0	61	WTD1P/PETN1
10	PCM_SYNC/LPCRSTN	36	RBI_DT	62	NC
11	WGR_D1N	37	PETN0	63	GND
12	PCM_IN	38	CLINK_REST	64	REF_CLK
13	GND	39	GND	65	WTD0N/PETP1
14	PCM_OUT	40	CLINK_DATA	66	NC
15	WGR_D0N	41	PERP0	67	WTD0P/PERN1
16	NC	42	CLINK_CLK	68	NC
17	WGR_D0P	43	PERN0	69	GND
18	GND	44	COEX3	70	PEWAKE1#
19	GND	45	GND	71	WTCLK/REFCLKP1
20	UART_WAKE	46	COEX_TXD	72	+3.3V
21	WGR_CLKN	47	REFCLKP0	73	WTCLK/REFCLKN1
22	BRI_RSP	48	COEX_RXD	74	+3.3V
23	WGR_CLKP	49	REFCLKN0	75	GND
24	KEY	50	SUSCLK		
25	KEY	51	GND		
26	KEY	52	PERST0#		

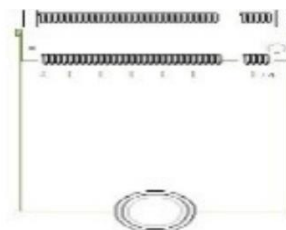

CN5 : Mini PCI-Express Socket (Support mPCIe / USB3 / SIM Module)

PIN	Definition	PIN	Definition
1	WAKE#	27	GND
2	VCC3SB_MPCIE3	28	+1_5VRUN
3	NA	29	GND
4	GND	30	SMB_CLK
5	NA	31	PCIE_TXN1
6	+1_5VRUN	32	SMB_DATA
7	P_UIM_RST2	33	PCIE_TXP1
8	P_UIM_PWR	34	GND
9	GND	35	GND
10	P_UIM_DATA	36	USB2_CON_N8
11	CLKC_MIN3_N	37	GND
12	P_UIM_CLK	38	USB2_CON_P8
13	CLKC_MIN3_P	39	VCC3SB_MPCIE3
14	P_UIM_RST	40	GND
15	GND	41	VCC3SB_MPCIE3
16	P_UIM_VPP	42	NC
17	P_UIM_CLK2	43	GND
18	GND	44	NC
19	P_UIM_DATA2	45	NC
20	VCC3SB_MPCIE3	46	NC
21	GND	47	NC
22	MPCIE1_RST#	48	+1_5VRUN
23	PCIE_RXN1	49	NC
24	VCC3SB_MPCIE3	50	GND
25	PCIE_RXP1	51	NC
26	GND	52	VCC3SB_MPCIE3

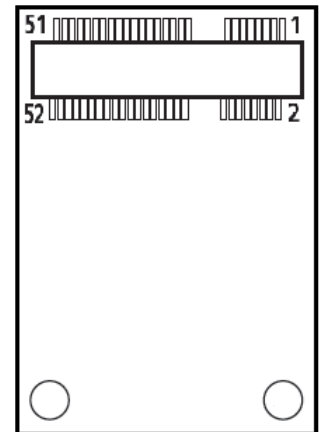

CN8 : M.2 Key M Socket (Support NVMe PCIe / SATA Storage)

(Pin 59~66 are connector keys)

Pin	Definition	Pin	Definition	Pin	Definition
1	CFG3	27	GND	53	REFCLKN
2	3.3V	28	NC	54	PEWAKE*/NC
3	GND	29	PERN1	55	REFCLKP
4	3.3V	30	NC	56	NC
5	PERN3-	31	PERP1	57	GND
6	NC	32	NC	58	NC
7	PERP3	33	GND	67	NC
8	NC	34	NC	68	SUSCLK
9	GND	35	PETN1	69	PEDET/CFG1
10	DAS/DSS*	36	NC	70	3.3V
11	PETN3	37	PETP1	71	GND
12	3.3V	38	DEVSLP	72	3.3V
13	PETP3	39	GND	73	GND
14	3.3V	40	SMB_CLK	74	3.3V
15	GND	41	PERN0/SATA_B+	75	CFG2
16	3.3V	42	SMB_DATA		
17	PERN2	43	PERP0/SATA_B-		
18	3.3V	44	ALERT#		
19	PERP2	45	GND		
20	NC	46	NC		
21	CFG0	47	PETN0/SATA_A-		
22	NC	48	NC		
23	PETN2	49	PETP0/SATA_A+		
24	NC	50	PERST*/NC		
25	PETP2	51	GND		
26	NC	52	CLKREQ*/NC		



CN6 : PWR and Reset remote connector

Connector Type: Terminal Block 2X2 4-pin, 3.5mm pitch

Pin	Definition
1	PWR_SW
2	RESET_SW
3	GND
4	GND



WARNING

**Do not apply power to this connector!
This port is used to connect a SWITCH!**

COM1 / COM2 : RS232 / RS422 / RS485 Connector

Connector Type: 9-pin D-Sub

Pin	RS232 Definition	RS422 / 485 Full Duplex Definition	RS485 Half Duplex Definition
1	DCD	TX-	DATA -
2	RXD	TX+	DATA +
3	TXD	RX+	
4	DTR	RX-	
5	GND		
6	DSR		
7	RTS		
8	CTS		
9	RI		



DC_IN1 : 3 PINs x2 DC 9-48V power input with power ignition connector

Connector Type: 2x 3-pins Terminal Block , 5.0mm pitch

Pin	Definition	Pin	Definition
1	9_48VSB_IN	4	9_48VSB_IN
2	9_32VSB_ACC (IGN)	5	Chassis GND
3	GND	6	GND

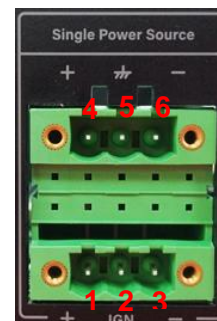

WARNING

**Only Single Power Source can connect to DC_IN1.
Please disconnect the power source before mounting the DC power cables or connecting the DC power connector to system.**

LAN LED Status Definition

Link LED Status	Definition
Steady Green	1 Gbps Network Link
Steady Orange	100 Mbps Network Link
Off	10 Mbps Network Link
Act LED Status	Definition
Blinking Yellow	Data Activity
Steady Yellow	No Activity

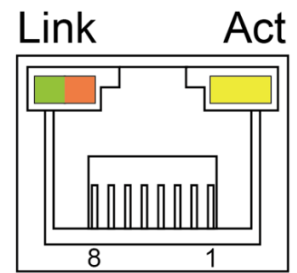

LED_B1 : LED board connector for NVMe HDD / IGN Thermal / IGN Power / GPIO / PoE Function / SATA HDD / System Power LED

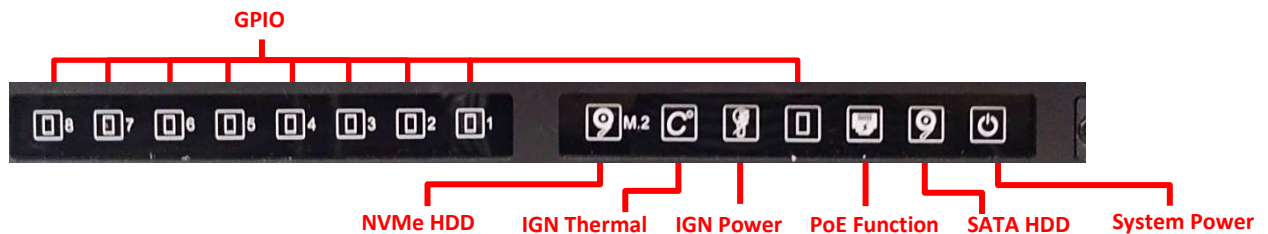

LED Type	Status	LED Color
NVMe HDD LED	Data activity	Blinking Yellow
	No activity	Off
IGN Thermal LED	System Temp $\leq 65^{\circ}\text{C}$	Off
	$65^{\circ}\text{C} < \text{System Temp} \leq 70^{\circ}\text{C}$	Blue
	$70^{\circ}\text{C} < \text{System Temp} \leq 75^{\circ}\text{C}$	Red
	$75^{\circ}\text{C} < \text{System Temp}$	Blinking Red
IGN Power LED	ACC ON	Blue
	System boot up	Green
GPIO LED	GPIO activity	Green
	No activity	Off
PoE Function LED	PoE module detected	Green
	PoE module not detected	Off
HDD LED	Data activity	Blinking Yellow
	No activity	Off
System Power LED	Power on	Green
	Standby	Blinking Green and Blue
	Power off	Blue

POWER1 (FAN OUT Control) : System thermal sensor for system smart fan

Connector Type: 1x4 4-pin Wafer, 2.0mm pitch

Pin	Definition
1	GND
2	+VCC12
3	RPM
4	PWM



POWER2 (FAN IN Control) : CPU thermal sensor for CPU smart fan

Connector Type: 1x4 4-pin Wafer, 2.0mm pitch



Pin	Definition
1	GND
2	+VCC12
3	RPM
4	PWM



POWER1 (FAN OUT Control)



POWER2 (FAN IN Control)



Chapter 3

System Setup

3.1 Removing Top Cover



WARNING

In order to prevent electric shock or system damage, before removing the chassis cover, must turn off power and disconnect the unit from power source.

1. Loosen the 4 screws on the top plate and then remove the top plate.

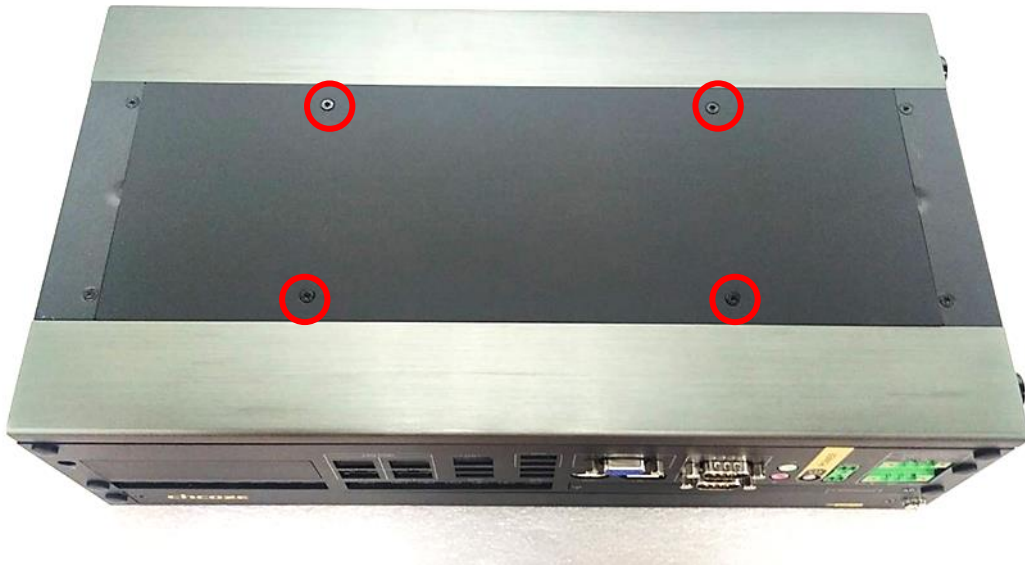

2. Loosen the 2 screws on the top cover.



3. Loosen the 6 screws on the side and rear panel of the system.

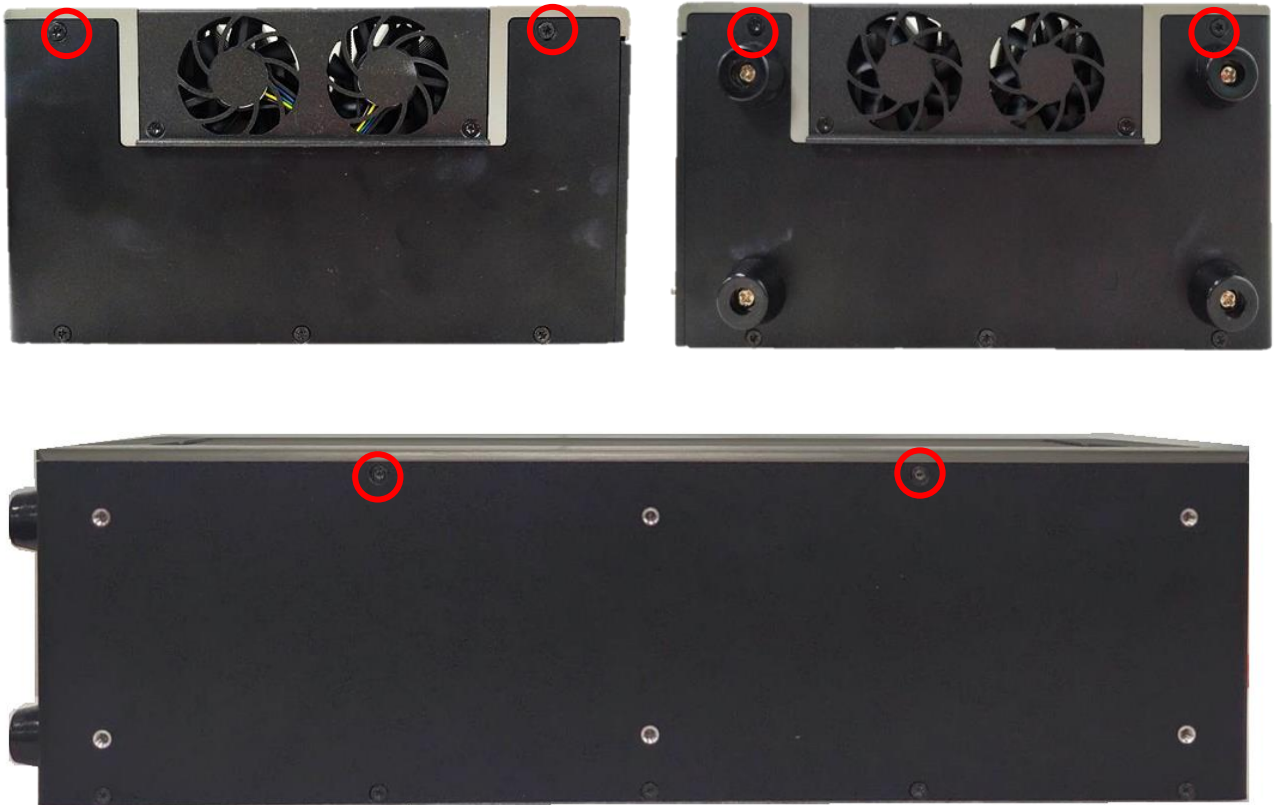

4. Remove the top cover from the chassis.



5. Place the top cover aside gently.

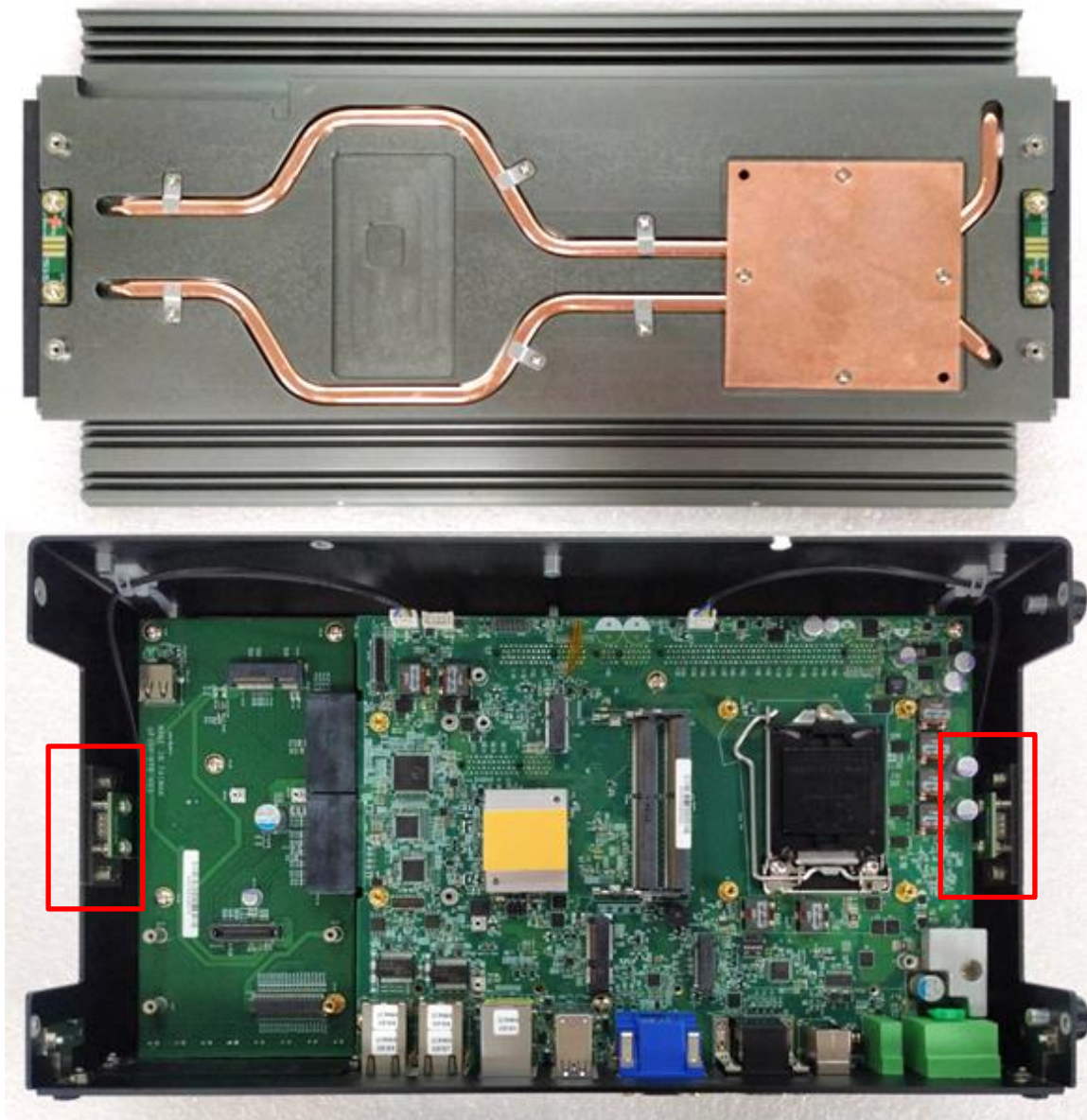

WARNING

During the following entire installation procedures, please be careful not to touch the pins on the fan power connector. Otherwise, the fan power connector will be damaged and may not work properly.

3.1 Installing CPU

1. Locate the CPU socket.

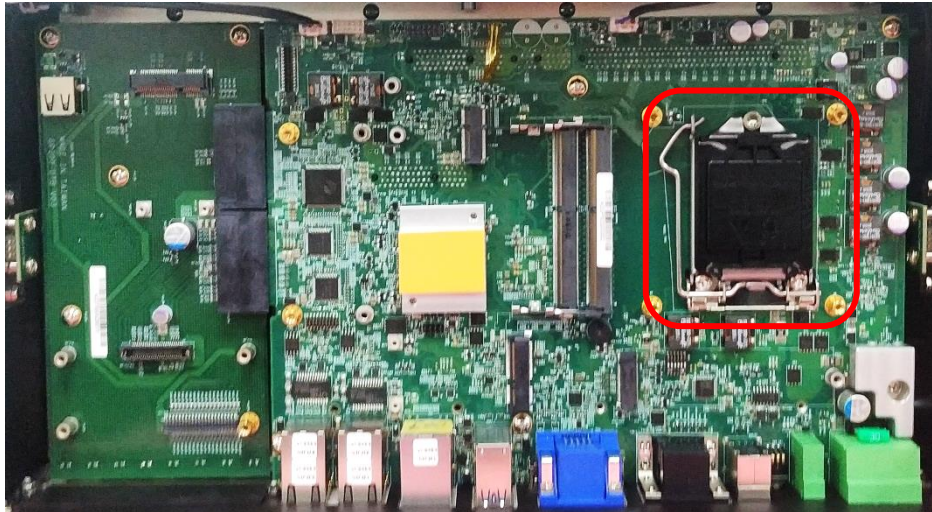

2. Pull aside and then lift up the socket lever to unlock the socket.



3. Align the notches on the CPU with protrusions on the socket. Hold the CPU by the edges and put on the CPU gently.

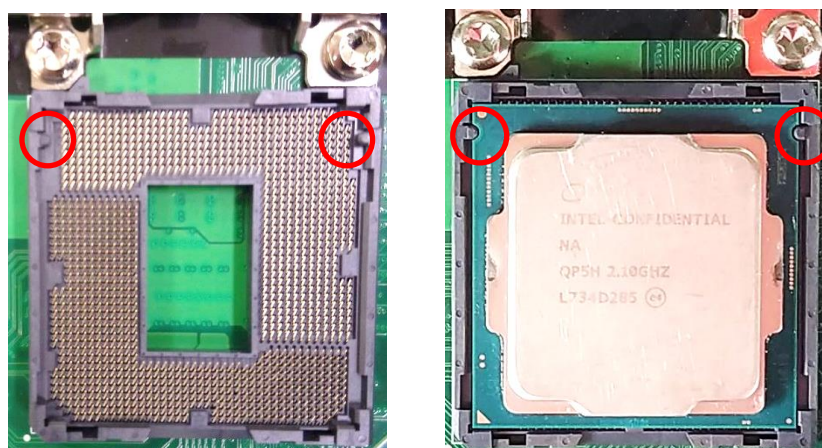

- Place the thermal pad on the CPU heat spreader. Press down the socket lever to lock the CPU.

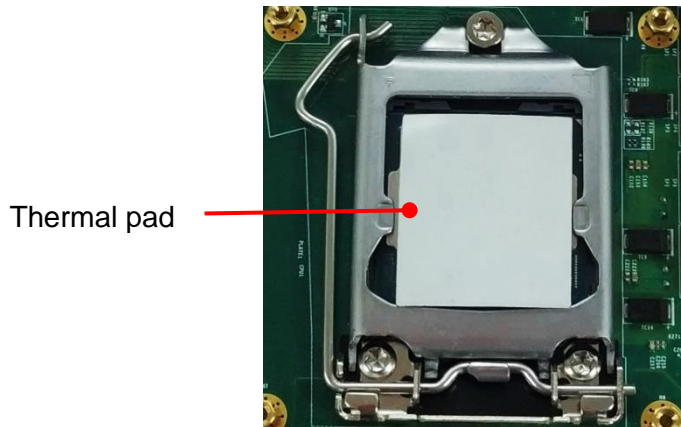

CAUTION

Before putting on the heatsink (in the next step), please make sure the transparent protective film on the Thermal Pad has been removed!

- Aim at the four mounting holes and put on the CPU heat sink according to the picture below. Fasten two screws at upper left and lower right corners. Screws at upper right and lower left corners need not to fasten here, they will be fastened in the step 3 of Chapter 3.8.

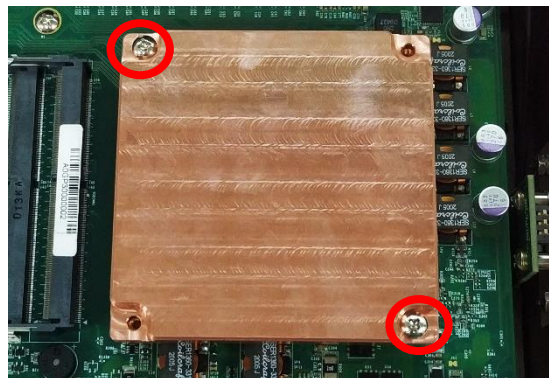

- Place the thermal pad on the CPU heat sink.

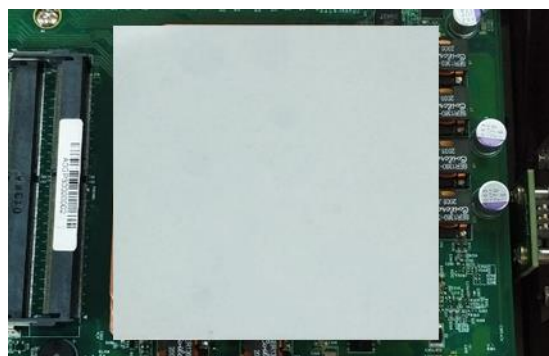

CAUTION

Before assembling the system's chassis cover, please make sure the transparent protective film on the Thermal Pad has been removed!

3.2 Installing SO-DIMM

1. Locate the SODIMM socket.

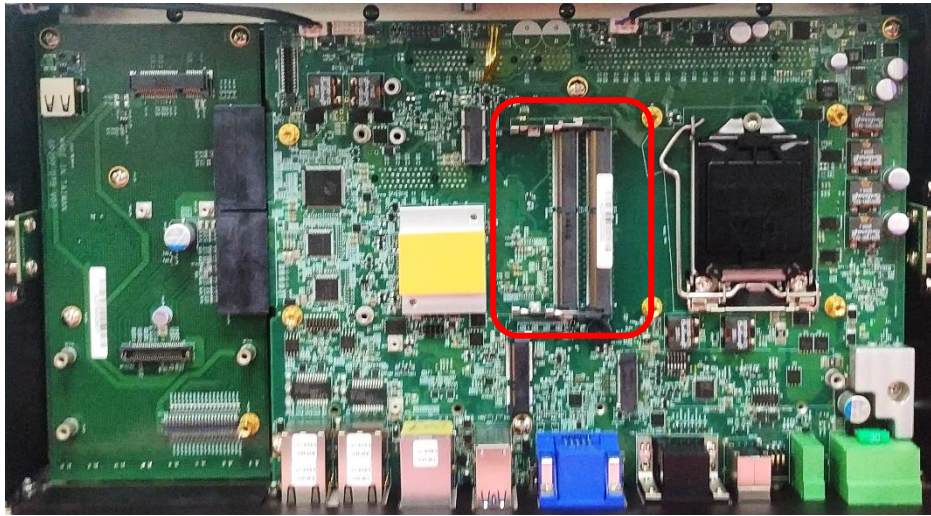

2. Insert a SO-DIMM at a 45-degree angle until its edge connector is connected to SO-DIMM socket firmly.

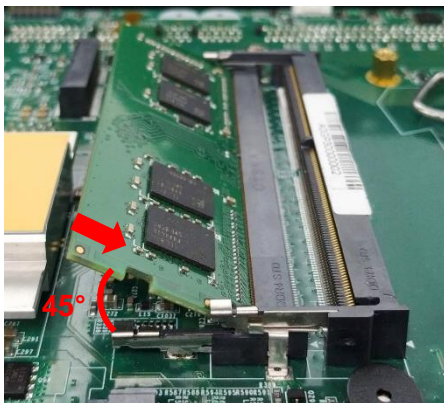

Lower socket

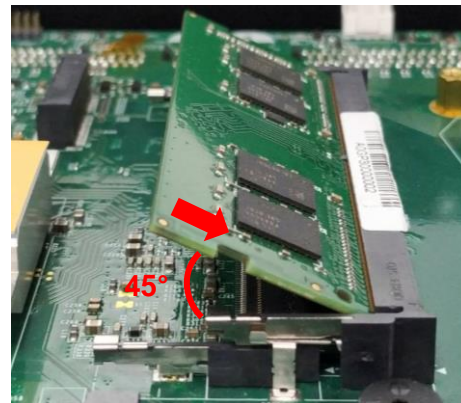

Upper socket

3. Press down the module until the retaining clips snap back in place.



Lower socket



Upper socket

3.3 Installing Mini-PCle Card

1. Locate the Mini PCIe socket CN1_DB on DP-300 DTB and CN5 on the system motherboard.

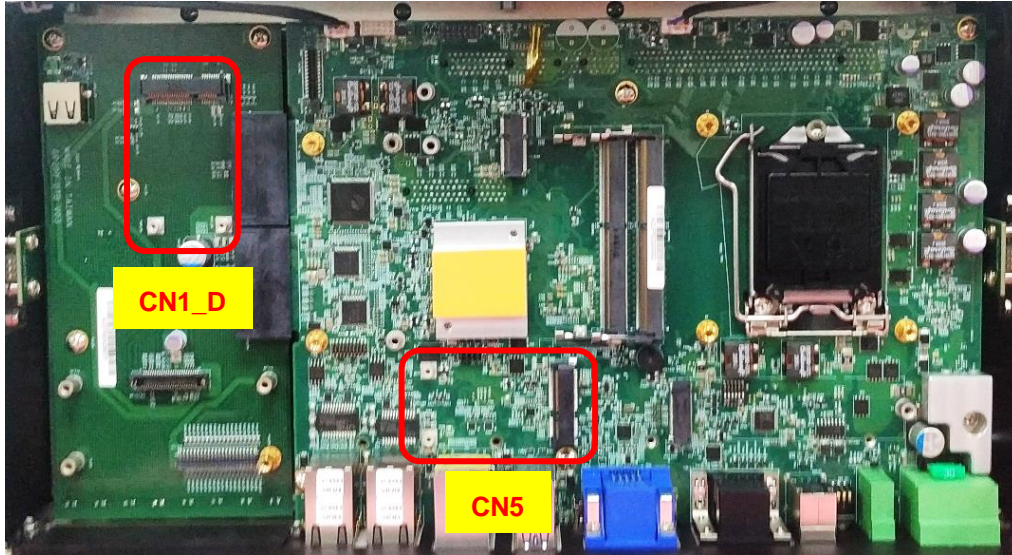

2. Tilt the Mini PCIe card at a 45-degree angle and insert it to the socket until the golden finger connector of the card seated firmly.



3. Press the card down and secure it with 2 screws.



3.4 Installing M.2 E Key Card

1. Locate the M.2 E Key slot (CN2) on the system motherboard.

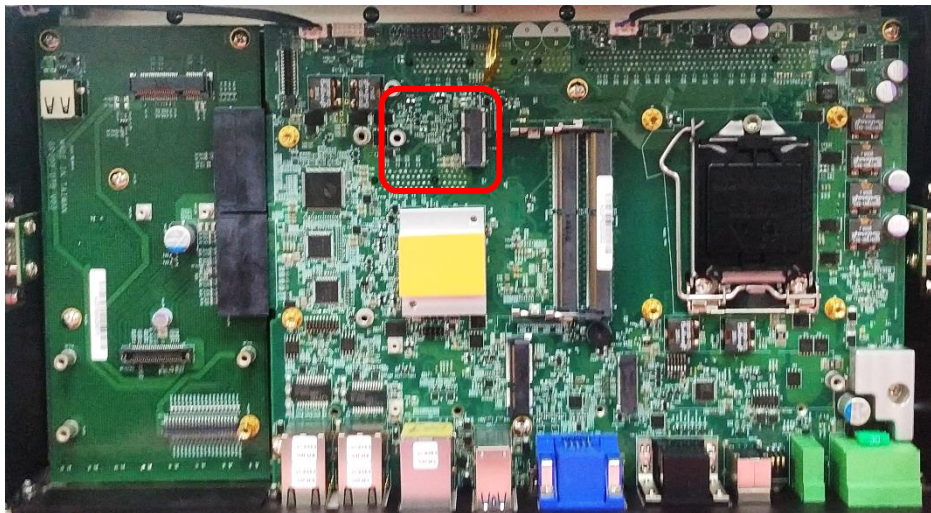

2. Tilt the M.2 E Key card at a 45-degree angle and insert it to the socket until the golden finger connector of the card seated firmly.



3. Press the card down and secure it with 1 screw.



3.5 Installing M.2 M Key Card

1. Locate the M.2 M Key slot (CN8) on the system motherboard.

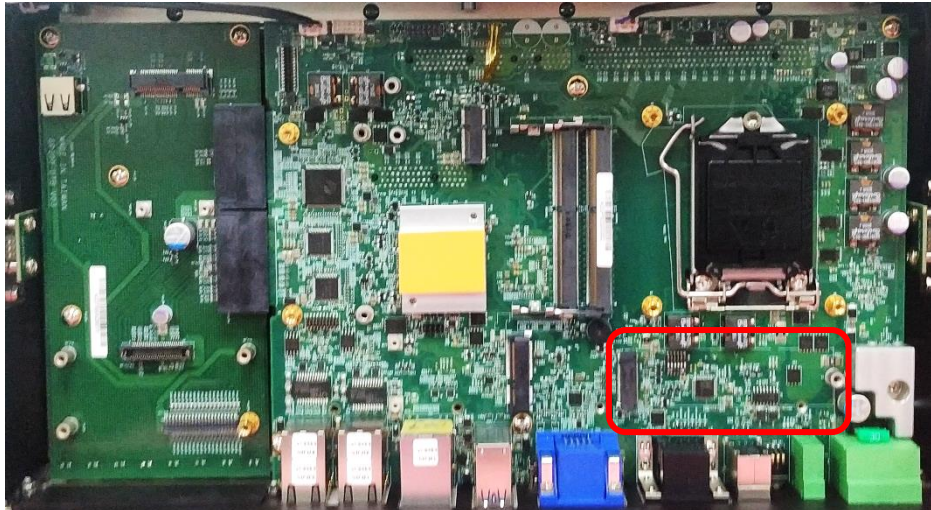

2. Tilt the M.2 M Key card at a 45-degree angle and insert it to the socket until the golden finger connector of the card seated firmly.



3. Press the card down and secure it with the screw.



3.6 Installing Antenna

3.6.1 Antenna #1 to #4

1. Remove the antenna rubber cover on the rear panel.



2. Penetrate the antenna jack through the hole.



3. Put on the washer and fasten the nut of antenna jack.



4. Assemble the antenna and antenna jack together.



5. Attach the RF connector of the cable's another end onto the card.



3.6.2 Antenna #5 to #7

1. Remove the antenna rubber cover on the rear panel.



2. Grip the antenna jack with a tweezer and then penetrate it through the hole as indicated.



3. Put on the washer and fasten the nut of antenna jack.



4. Assemble the antenna and antenna jack together.



5. Attach the RF connector of the cable's another end onto the card.



3.7 Installing Thermal Pad on MOSFET Heatsink

1. As shown in the picture below, place thermal pad on the top of MOSFET heatsink in order to provide a seamless contact with the body of chassis to create an efficient heat dissipation.



CAUTION

Before assembling the system's chassis cover, please make sure the transparent protective film on the Thermal Pad has been removed!

3.8 Installing Top Cover

1. Put the top cover onto the chassis.



2. Fasten the 6 screws on the side and rear panel of the system.

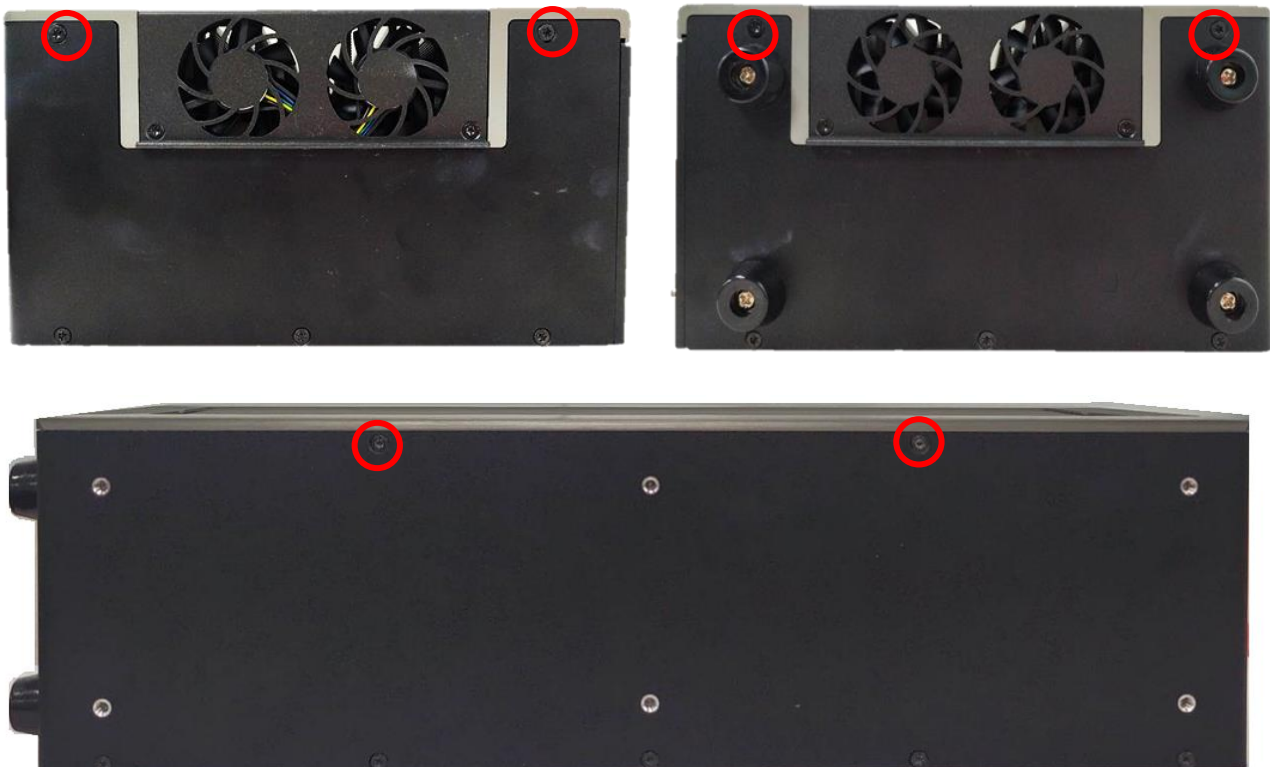

3. Fasten the 2 screws on the top cover.



4. Put on the top plate, and fasten the 4 screws to fix the top plate.

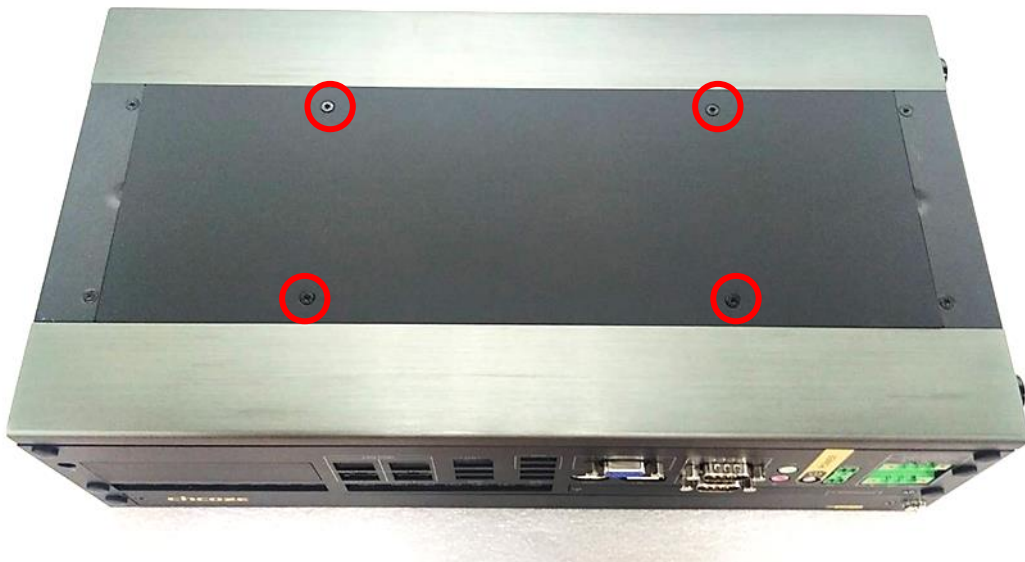

3.9 Installing SATA Hard Drives at Front Panel

1. Loosen the two screws to remove the front cover plate.



2. Loosen the screw(s) to remove the HDD bay cover bracket.



3. Pull the rotating arm and pull the HDD bracket out of system.



4. Make HDD bottom side face up, place the HDD bracket on it. Ensure the direction of bracket is correct and use 4 provided screws to assemble HDD and HDD bracket together.

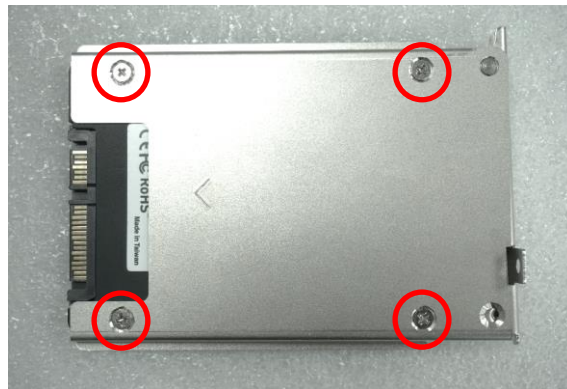

5. Align the HDD bracket with the entrance of HDD bay. Insert the HDD bracket and push it until the HDD connector is fully inserted into the SATA slot.



6. Place the rotating arm back and fasten the screw(s).



7. Fix the cover by fastening the two screws.



3.10 Installing SIM Card

1. Loosen the two screws to remove the cover plate of maintenance zone.



2. Locate the SIM card slot at front side and insert a SIM card into a SIM slot with the gold contacts facing down. Please pay attention to the insert orientation as illustrated.

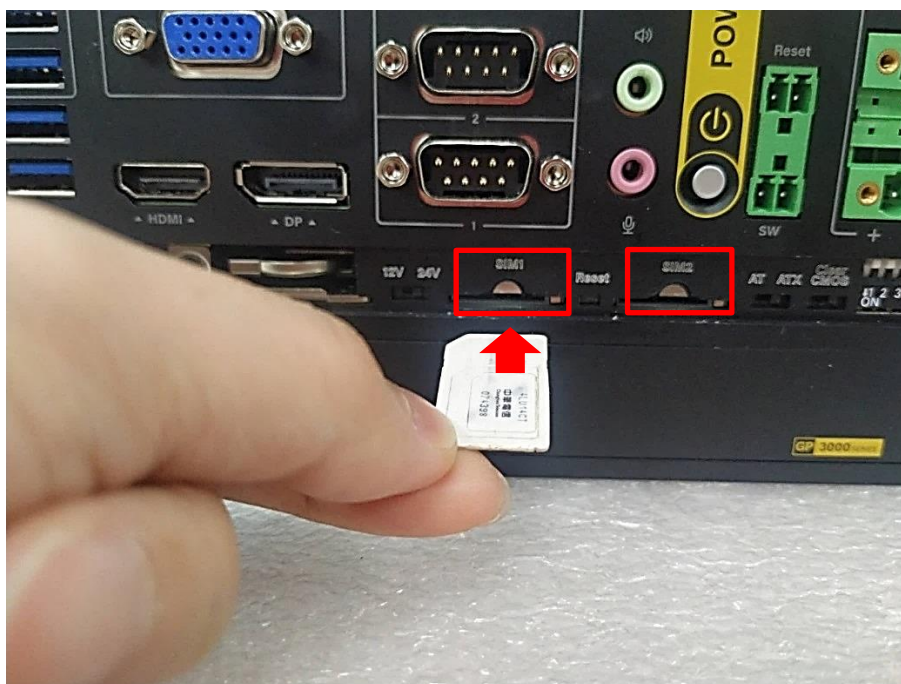

3. Fix the cover plate of maintenance zone by fastening the two screws.



3.11 Installing Rubber Foot Pad

1. Locate the four screw holes on the side panel.

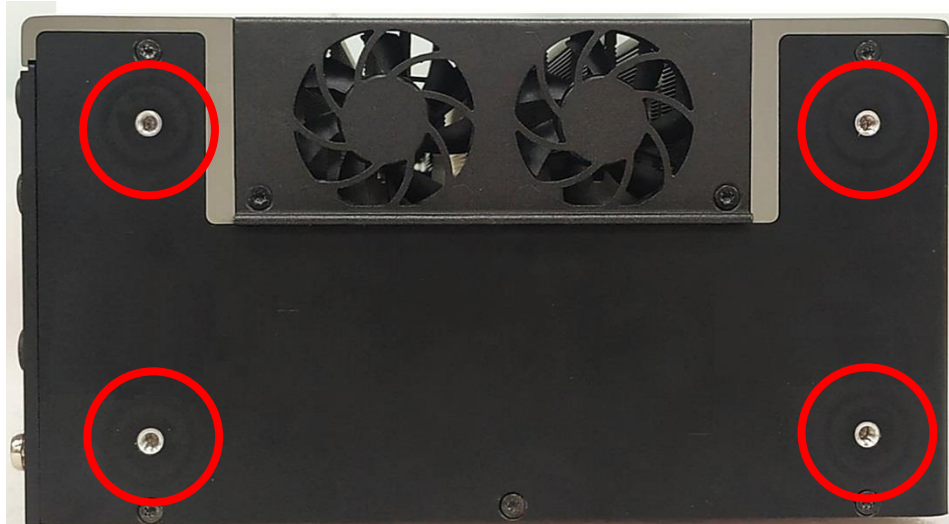

2. Attach on the four rubber foot pads and fasten the four screws to fix them.

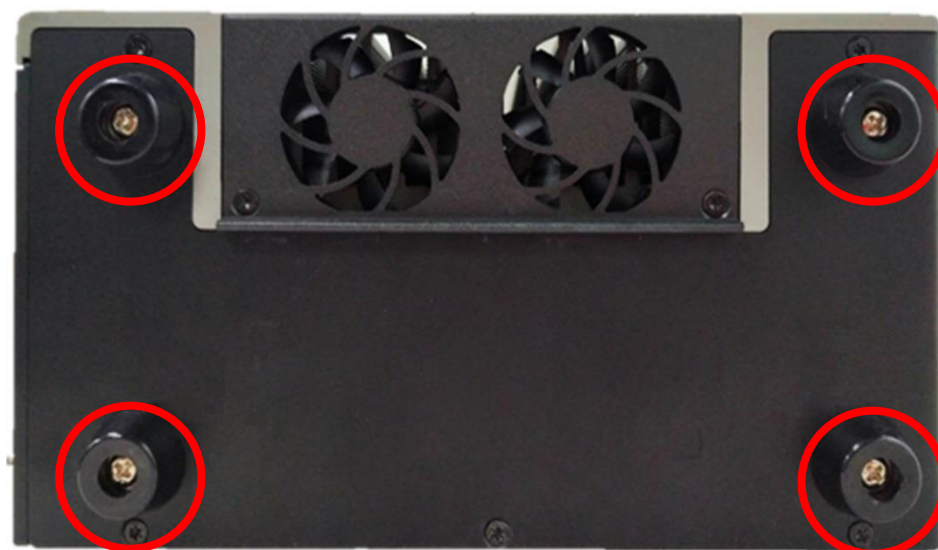
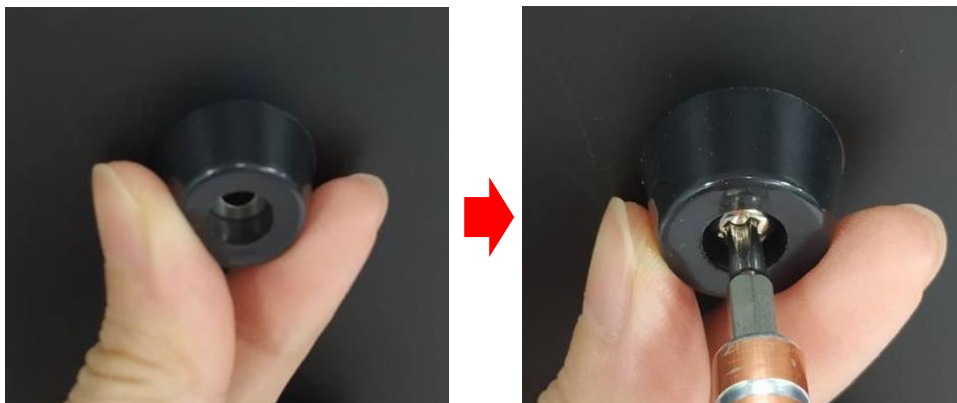

3.12 Installing Wall Mount

GP-3000 series offers wall mount kit that customers can install system on the wall in a convenient and economical way.



1. Attach the wall mount bracket onto the system according to the orientation shown below.



2. Use provided 6 screws to fasten the bracket.



3. The 2 bracket mounting holes are used to fix the system on the wall.



3.13 Installing Desktop Mount Bracket

GP-3000 series offers Desktop Mount Bracket that customers can easily and economically install system on some plane surfaces on-site.



3. Locate the screw holes on the bottom side of the system.

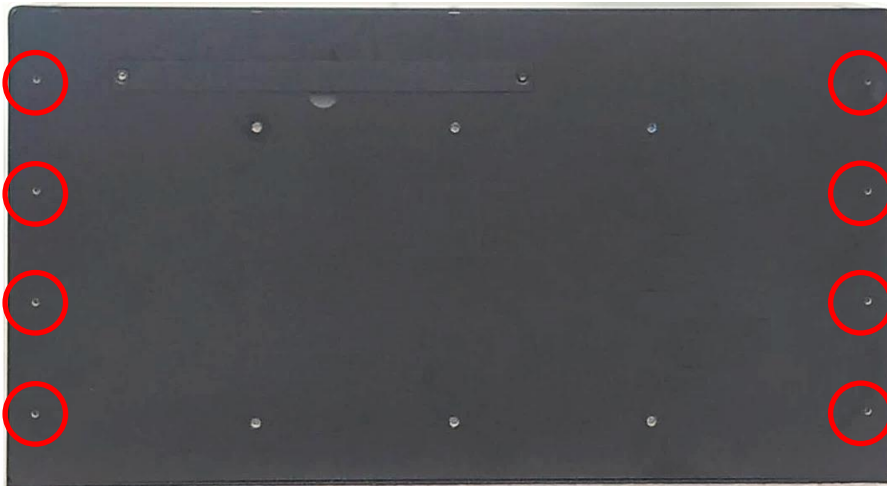

4. Attach the Desktop Mount Bracket and then fasten the 8 screws.

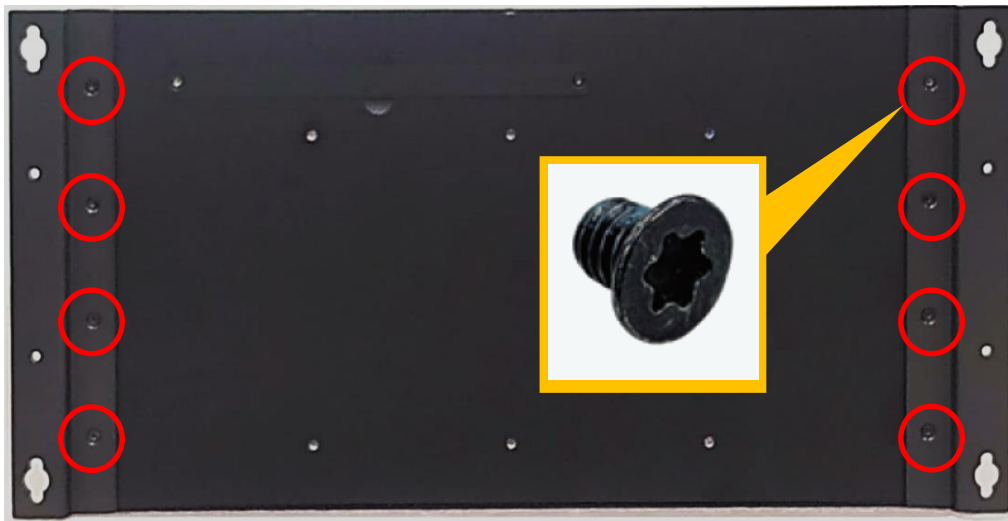

5. Attach on the four rubber foot pads and fasten the four screws to fix them.

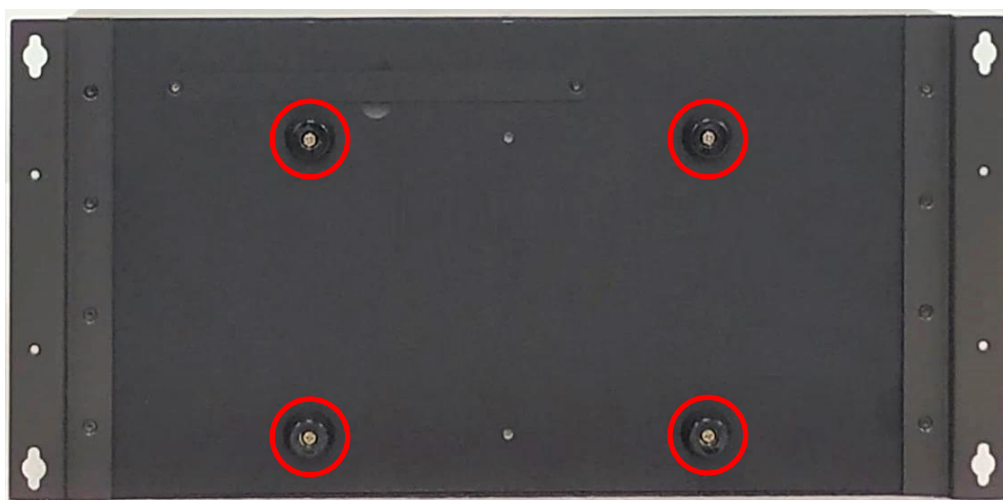

3.14 Installing 19" Rack Mount

GP-3000 provides 19" Rack Mount kit that customers can install the system onto the 19" Rack. There are two methods to install the system onto the 19" Rack, which are Method A and Method B as illustrated below.



Before installing GP-3000 onto the 19" Rack Mount, please follow the steps below to assemble the 19" Rack Mount kit first.

- (1) Locate the four screw holes



- (2) Attach the two handles onto the seat bracket, and fasten the four screws (M5X12) to fix them from the back side.

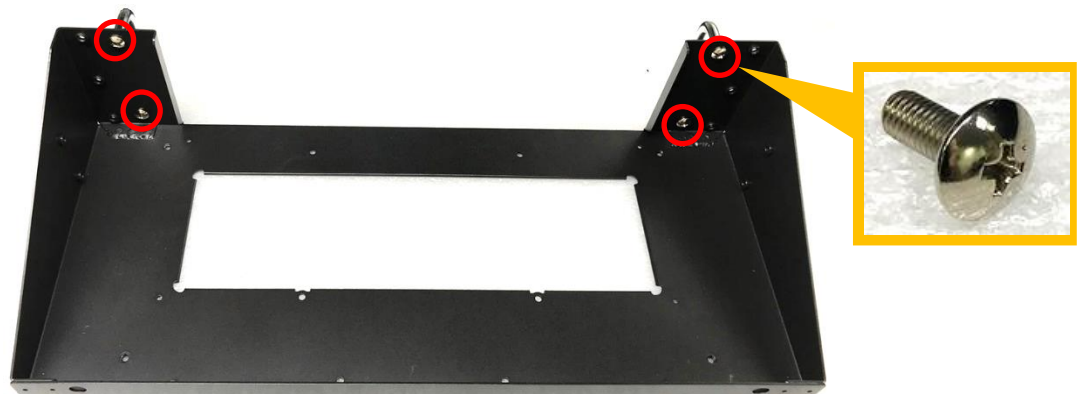

Method A

1. Place the GP-3000 into the assembled 19" Rack Mount kit.



2. Turn to the bottom side of the 19" Rack Mount kit, and fasten the four screws (P4X5L).

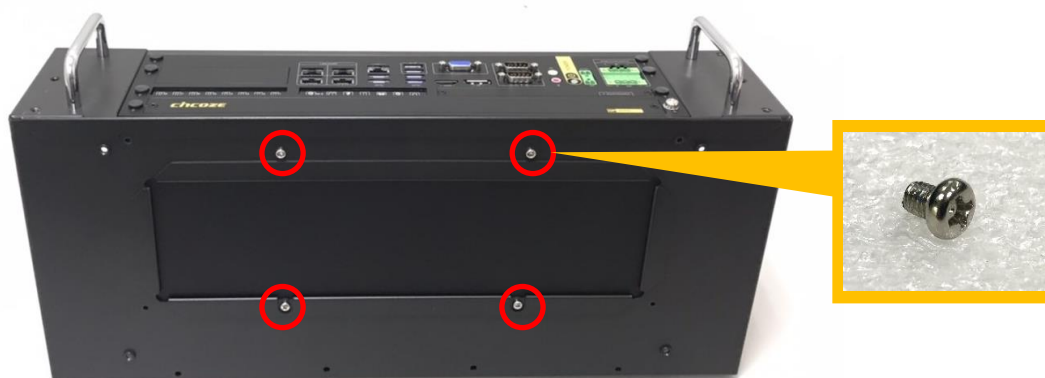

Method B

1. Get ready the GP-3000 installed with the desk mount according to Chapter 3.13. Place the GP-3000 with the desk mount into the assembled 19" Rack Mount kit.



2. Fasten the four screws (M5X12) through the desk mount holes.



After complete the Method A or Method B steps, install the GP-3000 with the 19" Rack Mount kit onto the 19" Rack by fastening the 4 screws to complete the installation.



3.15 Connecting to Power Supply

1. Locate the DC_IN1 power connector.



2. Aim the V- wire (black wire) at the V- port, and aim the V+ wire (white wire) at the V+ port on the DC_IN connector. Then connect the phoenix contacts of the power supply to the DC_IN connector.



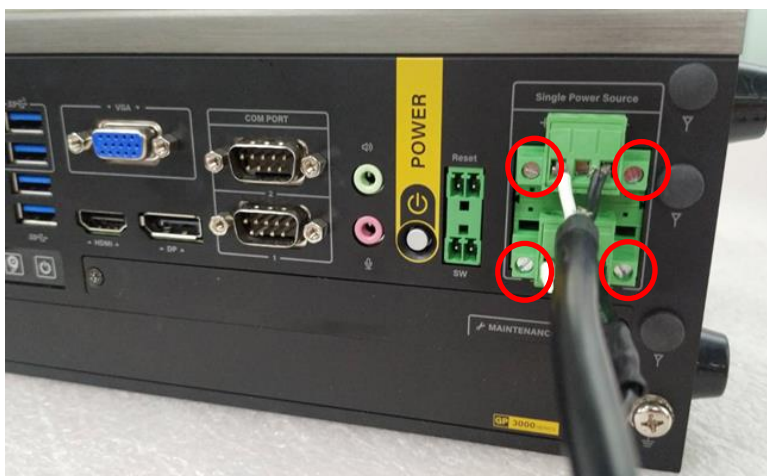

3. Fasten the four screws to fix the phoenix contacts.



CAUTION

In formal use, please use new Phoenix contacts and make sure the screws are tightened to avoid poor connection.



Chapter 4

BIOS Setup

4.1 BIOS Introduction

The BIOS (Basic Input/ Output System) is a program located on a Flash Memory on the motherboard. When you start the computer, the BIOS program will gain control. The BIOS first operates an auto-diagnostic test called POST (power on self-test) for all the necessary hardware, it detects the entire hardware device and configures the parameters of the hardware synchronization.

BIOS Setup

Power on the computer and by pressing immediately allows you to enter Setup. If the message disappears before your respond and you still wish to enter Setup, restart the system to try again by turning it OFF then ON or pressing <Ctrl>, <Alt> and <Delete> keys.

Control Keys	
<←> <→>	Move to select screen
<↑> <↓>	Move to select item
<Esc>	Quit the BIOS Setup
<Enter>	Select item
<Page Up/+>	Increases the numeric value or makes changes
<Page Down/->	Decreases the numeric value or makes changes
<Tab>	Select setup fields
<F1>	General help
<F2>	Previous value
<F3>	Load Optimized defaults
<F10>	Save configuration and Exit

Main Menu

The main menu lists the setup functions you can make changes to. You can use the arrow keys (↑↓) to select the item. The on-line description of the highlighted setup function is displayed at the bottom of the screen.

Sub-Menu

If you find a right pointer symbol appears to the left of certain fields that means a sub-menu can be launched from this field. A sub-menu contains additional options for a field parameter. You can use arrow keys (↑↓) to highlight the field and press <Enter> to call up the sub-menu. Then you can use the control keys to enter values and move from field to field within a sub-menu. If you want to return to the main menu, just press the <Esc >.

4.2 Main Setup

Press to enter BIOS CMOS Setup Utility, the Main Menu (as shown below) will appear on the screen. Use arrow keys to move among the items and press <Enter> to accept or enter a sub-menu.

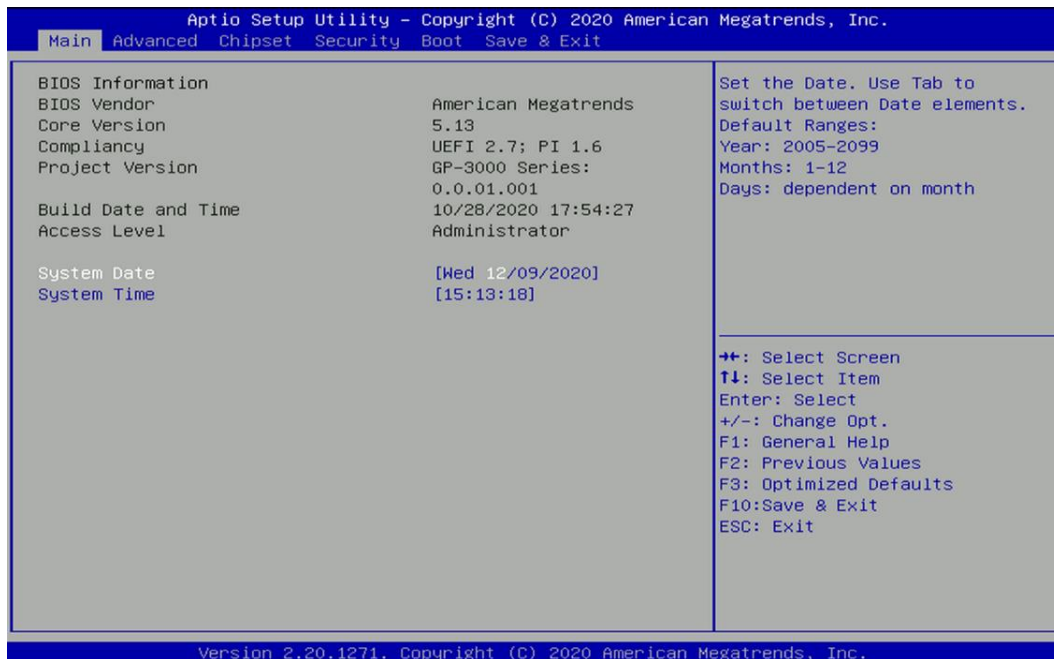

4.2.1 System Date

Set the date. Please use <Tab> to switch between date elements.

4.2.2 System Time

Set the time. Please use <Tab> to switch between time elements.

4.3 Advanced Setup

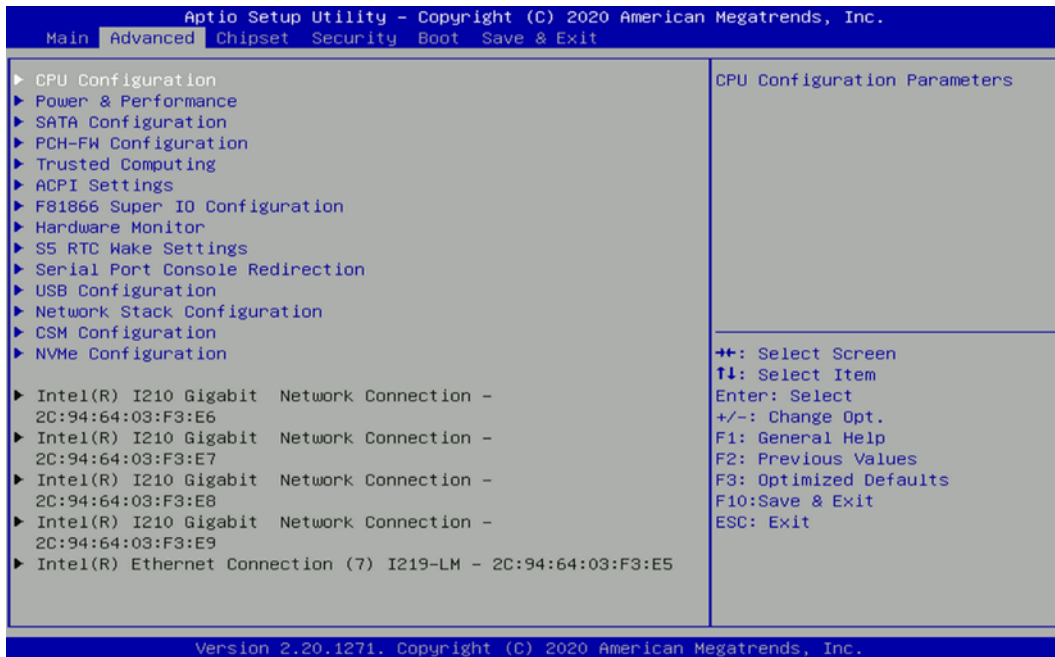

4.3.1 CPU Configuration

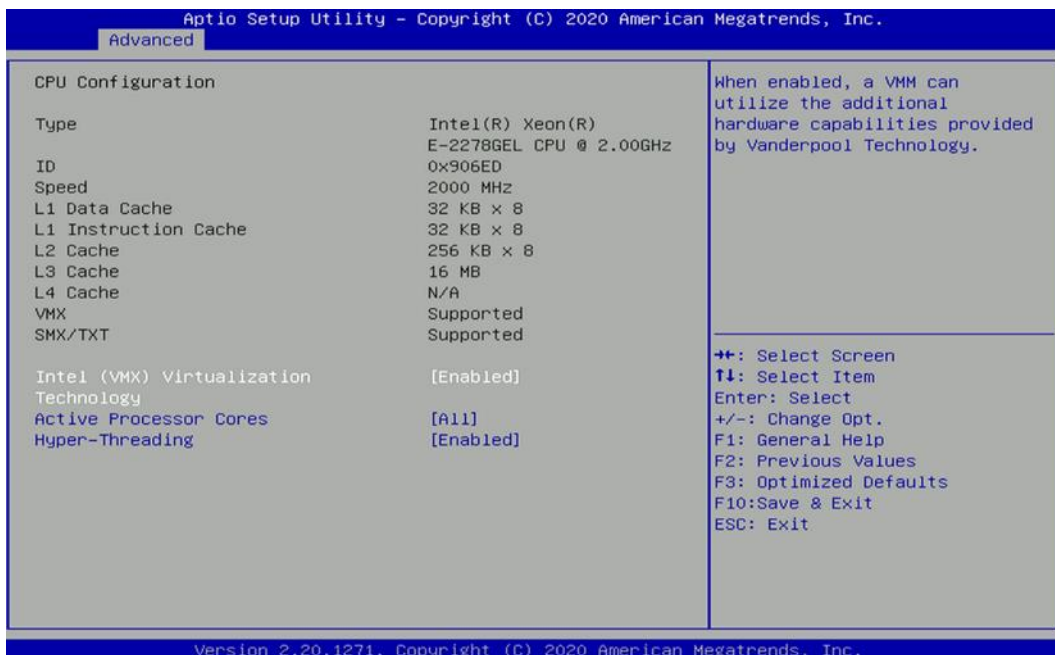

■ Intel® Virtualization Technology [Enabled]

Enables or disables Intel® Virtualization Technology. Virtualization enhanced by Intel® Virtualization Technology will allow a platform to run multiple operating systems and applications in independent partitions. With virtualization, one computer system can function as multiple virtual systems.

■ Active Process Cores [All]

Allows users to choose the number of active processor cores.

Configuration options: [All] [1] [2] [3] [4] [5] [6] [7]

■ Hyper-threading

Enables or disables for Hyper-Threading Technology.

4.3.2 Power & Performance

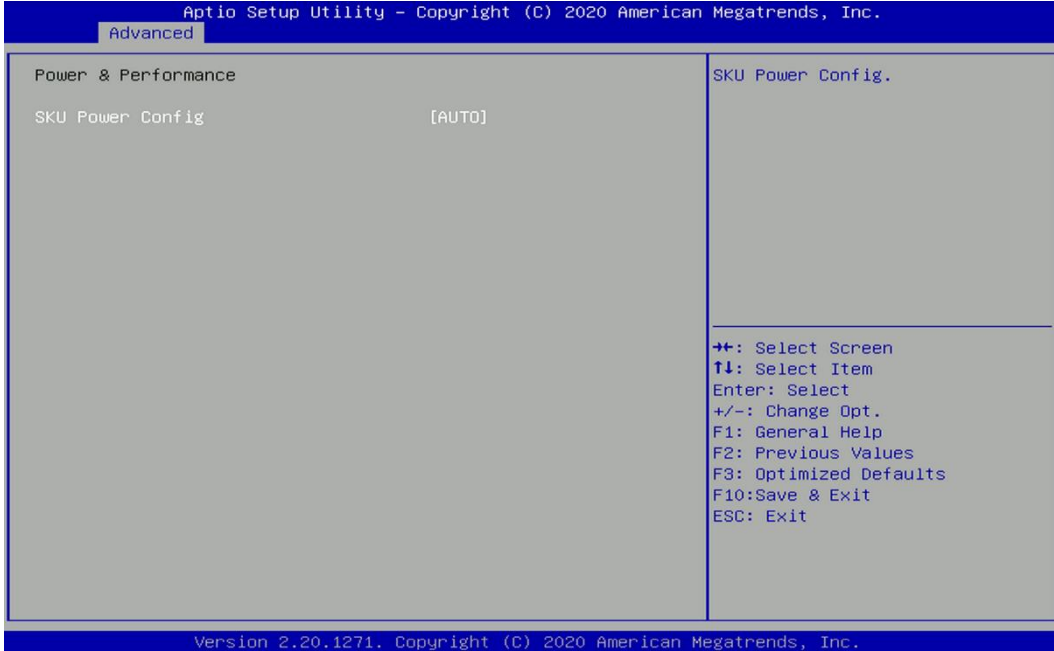

■ SKU Power Config [Auto]

Allows users to choose the upper limit of CPU power.

Configuration options: [Auto] [35W]

4.3.3 SATA Configuration

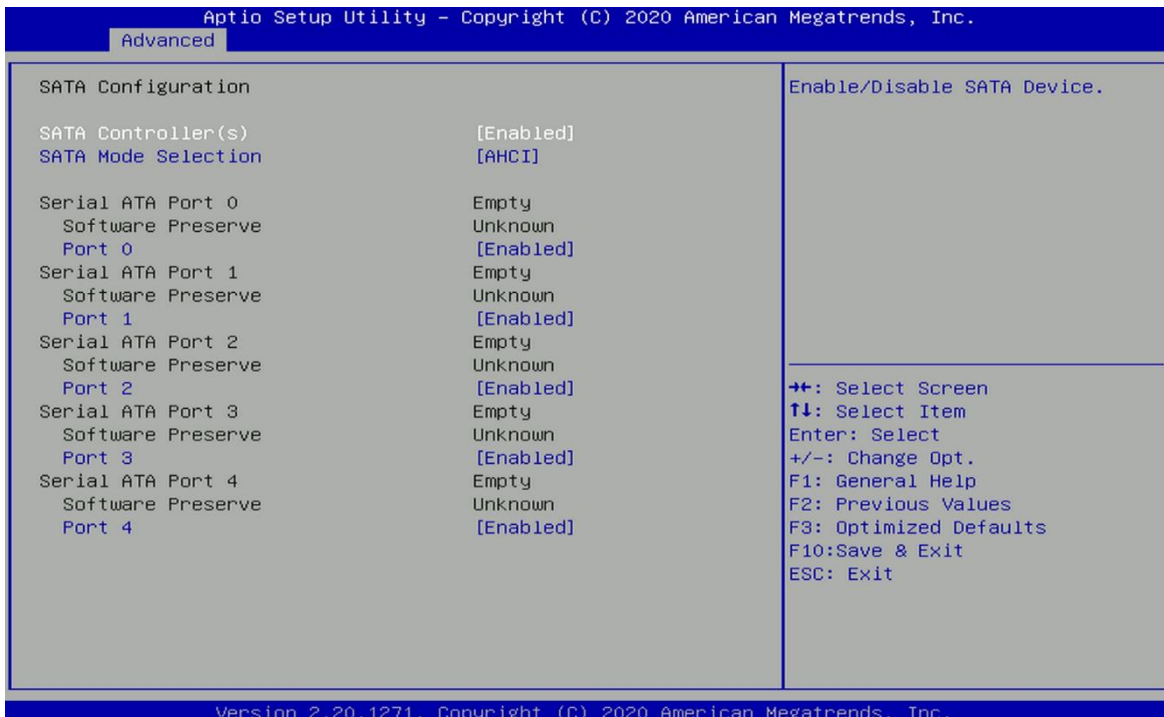

■ SATA Controller(s) [Enabled]

Enables or disables Serial ATA controller.

■ SATA Mode Selection [AHCI]

This item allows users to choose [AHCI] or [RAID] mode.

- Serial ATA Port 0**
Port 0 [Enabled]
Enables or disables SATA Port 0.
- Serial ATA Port 1**
Port 1 [Enabled]
Enables or disables SATA Port 1.
- Serial ATA Port 2**
Port 1 [Enabled]
Enables or disables SATA Port 2.
- Serial ATA Port 3**
Port 1 [Enabled]
Enables or disables SATA Port 3.
- Serial ATA Port 4**
Port 1 [Enabled]
Enables or disables SATA Port 4.

4.3.4 PCH-FW Configuration



■ Intel AMT [Enabled]

Allows users to enable or disable Intel® Active Management Technology BIOS execution.

■ Firmware Update Configuration

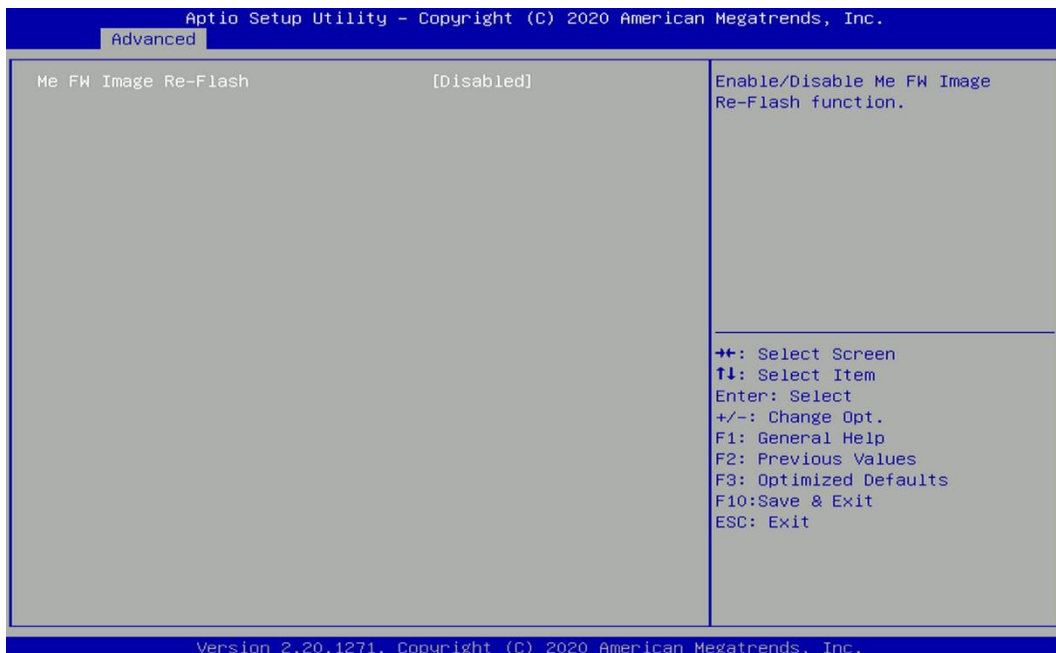

❑ ME FW Image Re-Flash [Disabled]

Allows users to enable or disable ME firmware image re-flash function.

4.3.5 Trusted Computing

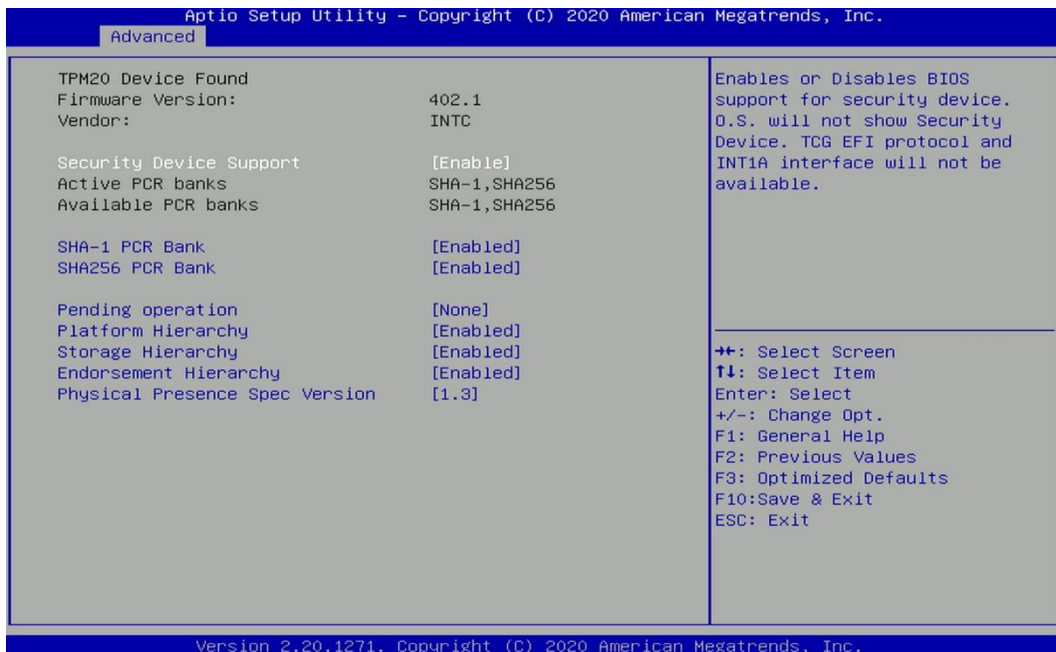

■ Security Device Support [Disable]

Allow users to enable or disable Security Device Support function.

■ SHA-1 PCR Bank [Enabled]

Enables or disables SHA-1 PCR Bank function.

■ **SHA256 PCR Bank [Enabled]**

Enables or disables SHA256 PCR Bank function.

■ **Pending Operation [None]**

Allows users to select which mode Pending Operation will operate.

Configuration options: [None], [TPM Clear]

■ **Platform Hierarchy [Enabled]**

Enables or disables Platform Hierarchy function.

■ **Storage Hierarchy [Enabled]**

Enables or disables Storage Hierarchy function.

■ **Endorsement Hierarchy [Enabled]**

Enables or disables Endorsement Hierarchy function.

■ **Physical Presence Spec Version [1.3]**

Allows users to select which mode Physical Presence Spec Version will operate.

Configuration options: [1.2], [1.3]

4.3.6 ACPI Settings

This item allows users to configure ACPI settings.

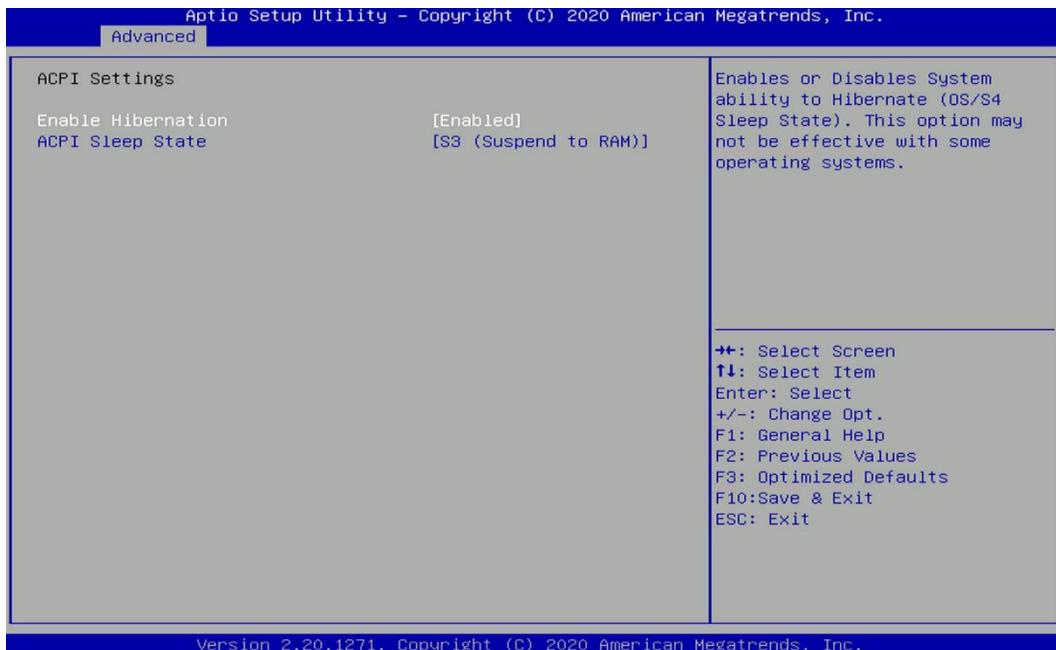

■ **Enable ACPI Auto Configuration [Enabled]**

Enables or disables BIOS Advanced Configuration Power Interface® (ACPI) auto configuration.

■ **ACPI Sleep State [S3 (Suspend to RAM)]**

Allows users to select the highest Advanced Configuration Power Interface® (ACPI) sleep state that system will enter when suspend button is pressed.

[Suspend Disabled]: Disables entering suspend state.

[S3 (suspend to RAM)]: Enables suspend to RAM state.

4.3.7 F81866 Super IO Configuration

The screen allows users to select options for the Super IO configuration, and change the value of the selected option.

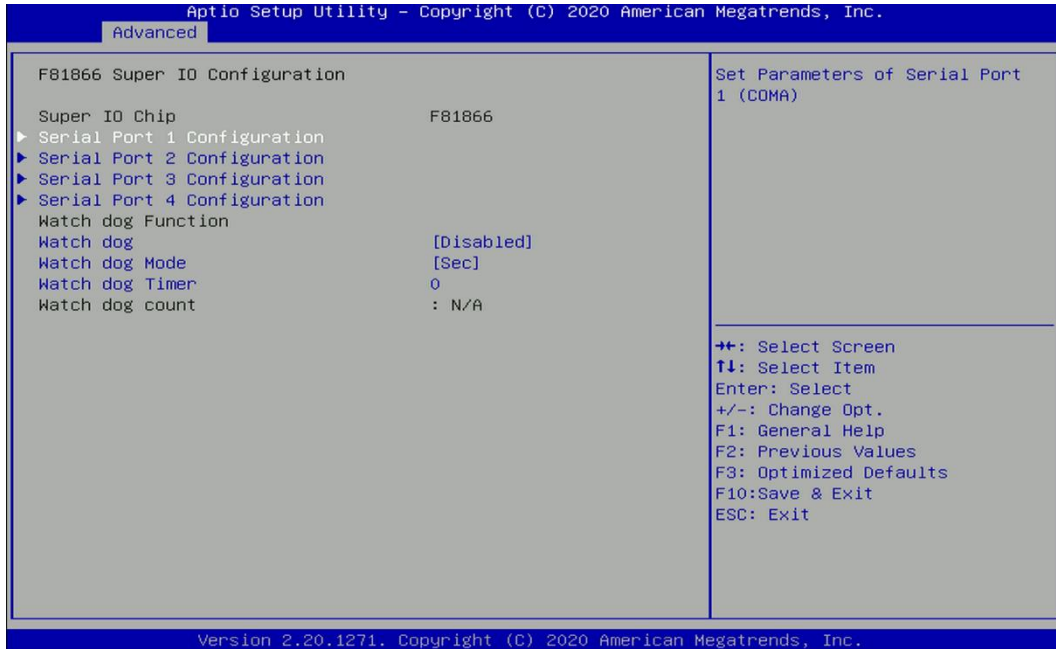

Serial Port 1~4 Configuration

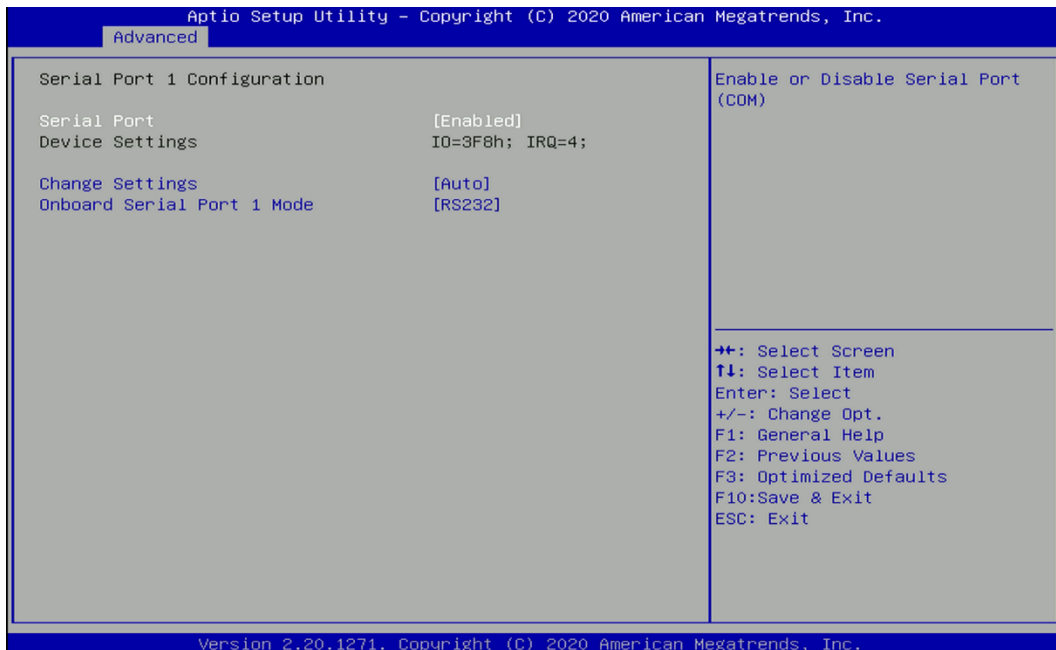

- Serial Port [Enabled]**
This item allows users to enable or disable serial port.
- Change Settings [Auto]**
This item allows users to change the address & IRQ settings of the specified serial port.

❑ Onboard Serial Port 1 Mode [RS232]

This item allows users to select Serial Port Mode.

Configuration options: [RS232] [RS422/RS485 Full Duplex] [RS485 Half Duplex]

■ Watch Dog [Disabled]

Enables or disables watch dog function.

■ Watch Dog Mode [Sec]

Changes the Watch dog mode. Select [Sec] or [Min] mode.

■ Watch Dog Timer [0]

User can set a value in the range of 0 to 255.

4.3.8 Hardware Monitor

These items display the current status of all monitored hardware devices/ components such as voltages and temperatures.

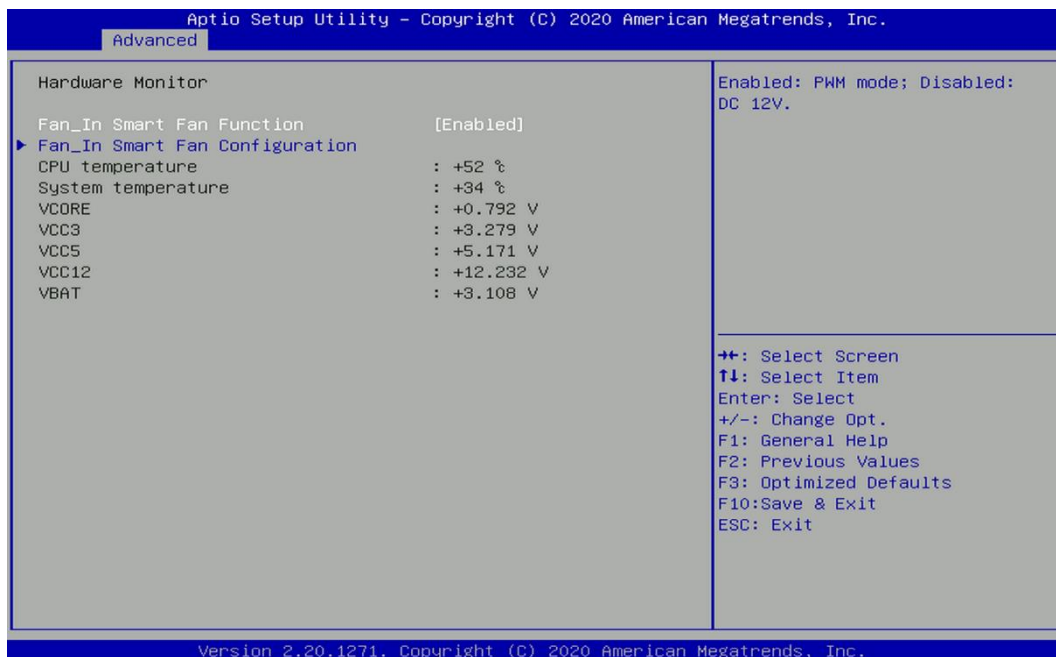

■ Fan-In Smart Fan Function [Enabled]

Enables or disables smart fan function.

■ Fan-In Smart Fan Configuration

Allows users to setting smart fan parameters.

4.3.9 S5 RTC Wake Settings

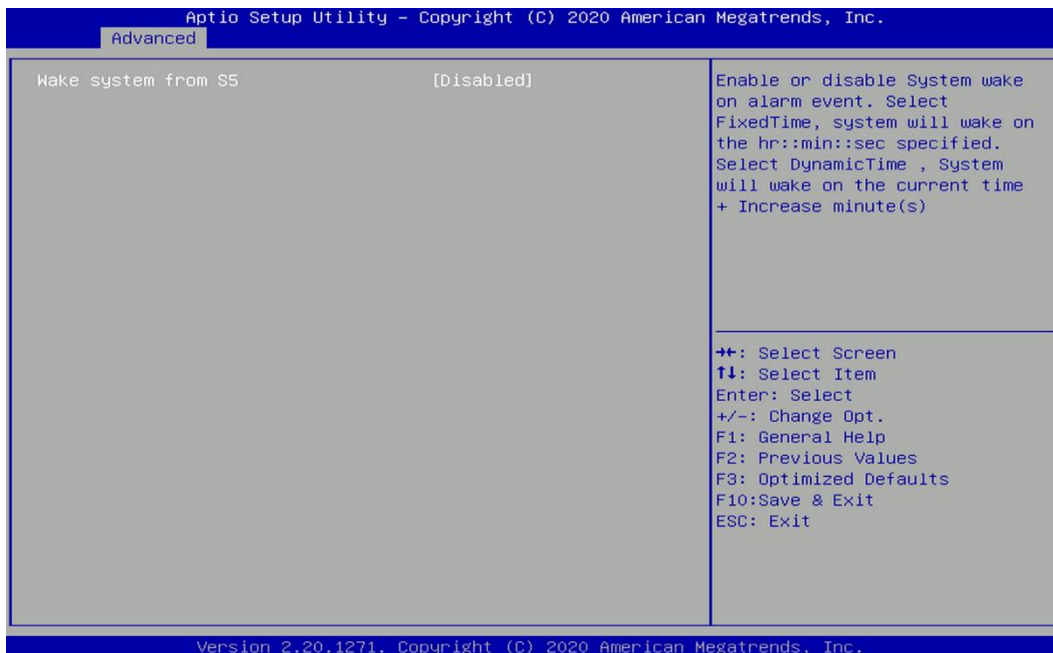

Wake System from S5 [Disabled]

This item allows users to change the way to wake system from S5 state.

[Fixed Time]: Set the specified time (HH:MM:SS) to wake system.

[Dynamic Time]: Set the increase time from current time to wake system.

4.3.10 Serial Port Console Redirection

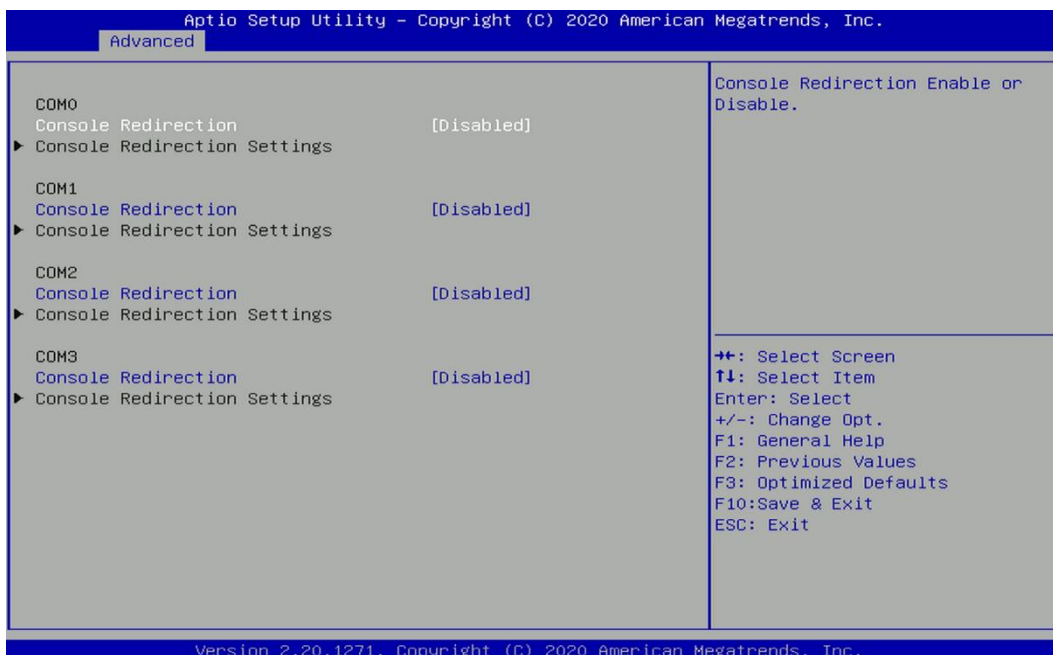

■ Console Redirection [Disabled]

These items allow users to enable or disable COM0, COM1, COM2, COM3 console redirection function.

4.3.11 USB Configuration

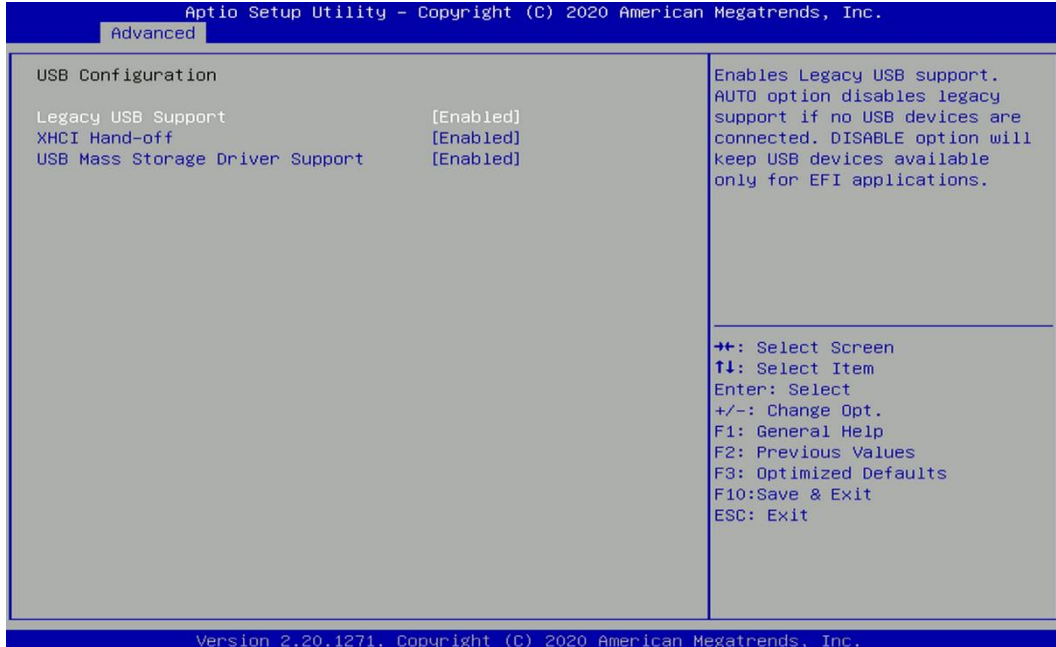

■ Legacy USB Support [Enabled]

This item allows users to enable or disable legacy USB support. When set to [Auto], legacy USB support will be disabled automatically if no USB devices are connected.

■ XHCI Hand-off [Enabled]

This item allows users to enable or disable XHCI (USB3.2) hand-off function.

■ USB Mass Storage Driver Support [Enabled]

Enables or disables support for USB mass storage devices.

4.3.12 Network Stack Configuration

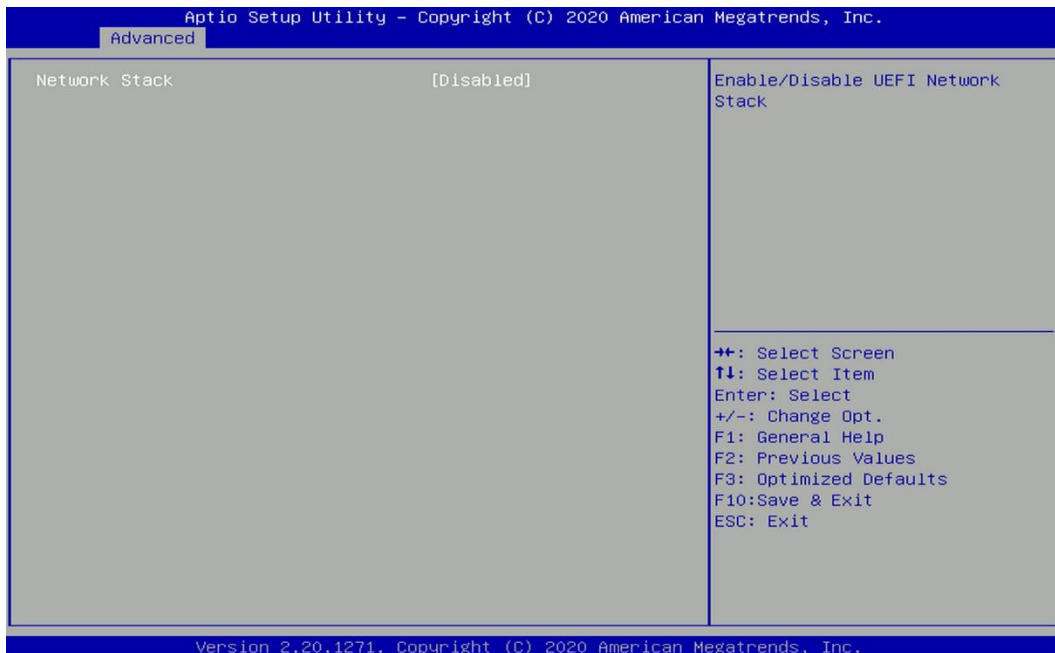

■ Network Stack [Disabled]

Enables or disables UEFI Network Stack.

4.3.13 CSM Configuration

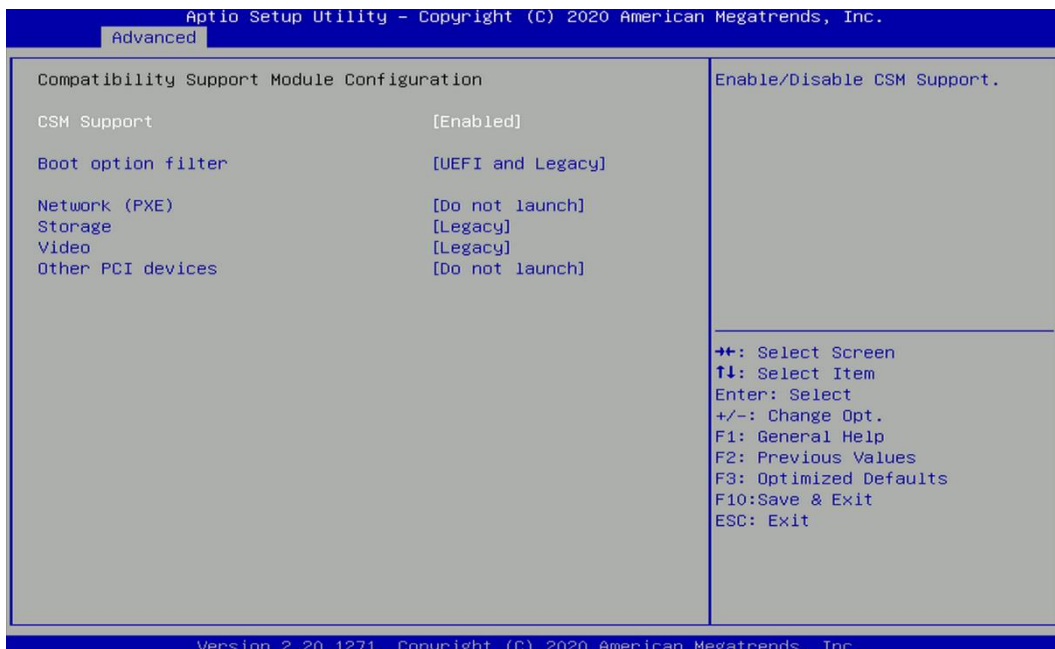

■ CSM Support [Enabled]

Enables or disables compatibility support module.

■ Boot option filter [UEFI and Legacy]

Allows users to select which type of operating system to boot.

[UEFI and Legacy]: Allows booting operating systems that support legacy or UEFI option ROM.

[Legacy only]: Allows booting operating systems that only support legacy option ROM.

[UEFI only]: Allows booting operating systems that only support UEFI option ROM.

■ **Network PXE [Do not launch]**

Controls the execution of UEFI and Legacy PXE (Network Preboot eXecution Environment) option ROM.

[Do not launch]: Disables option ROM execution.

[UEFI]: Enables UEFI option ROM only. [Legacy]: Enables legacy option ROM only.

■ **Storage [Legacy]**

Controls the execution of UEFI and Legacy Storage option ROM.

[Do not launch]: Disables option ROM execution.

[UEFI]: Enables UEFI option ROM only.

[Legacy]: Enables legacy option ROM only.

■ **Video [Legacy]**

Controls the execution of UEFI and Legacy Video option ROM.

[Do not launch]: Disables option ROM execution.

[UEFI]: Enables UEFI option ROM only.

[Legacy]: Enables legacy option ROM only.

■ **Other PCI devices [Do not launch]**

Allows users to determine option ROM execution policy for device other than network, storage, or video.

Configuration options: [Do not launch] [UEFI] [Legacy]

4.3.14 NVMe Configuration

The screen allows users to select options for the NVMe configuration, and change the value of the selected option. If there is NVMe Device detected, the options will show as the NVMe Device is found.

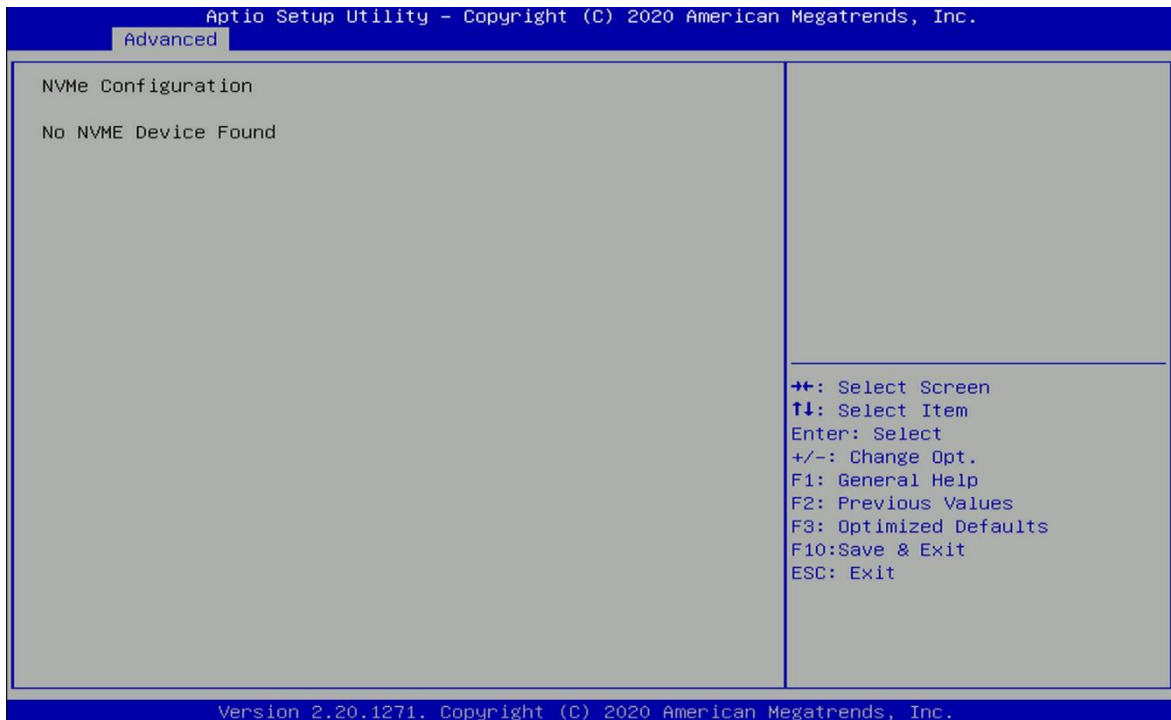

4.4 Chipset Setup

This section allows you to configure chipset related settings according to user's preference.

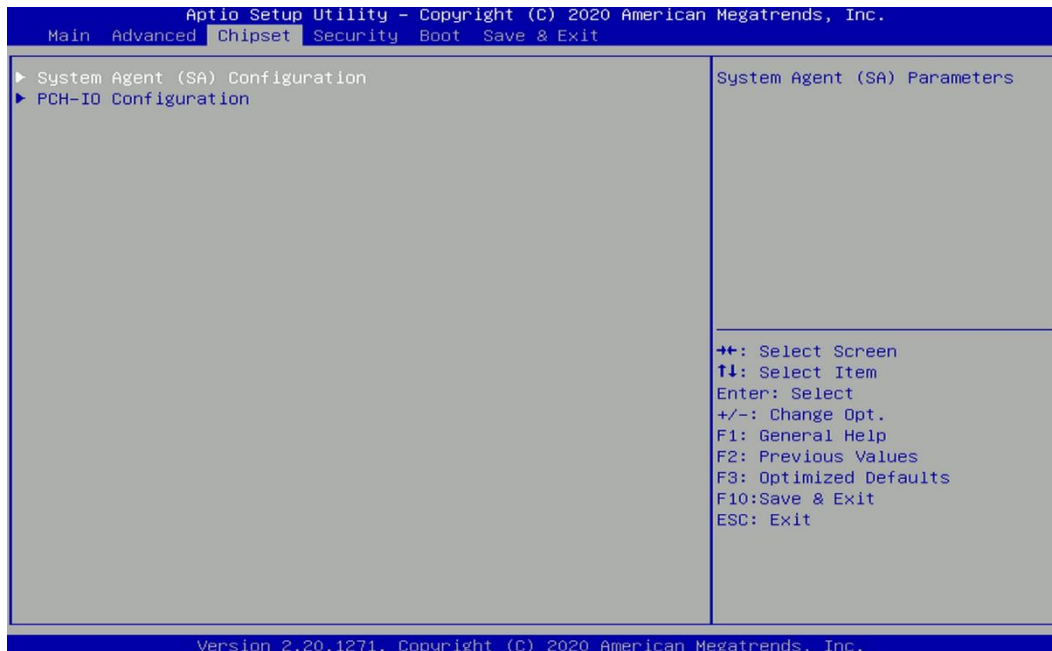

4.4.1 System Agent (SA) Configuration

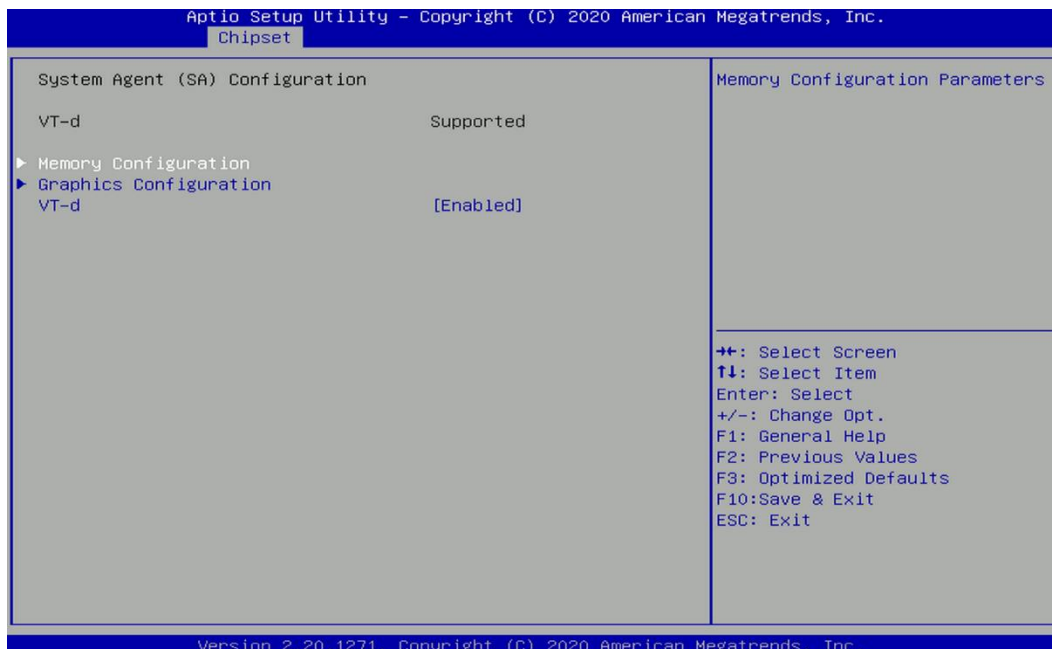

■ Memory Configuration

This item displays detailed memory information in the system.

■ Graphics Configuration

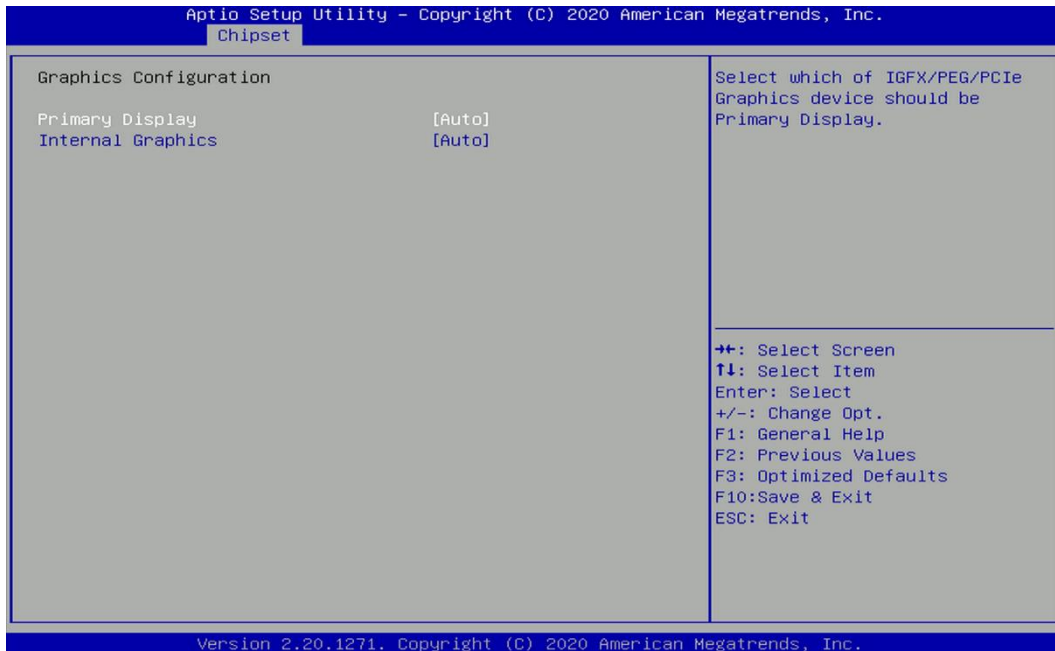

Primary Display [Auto]

Allows users to select which graphics device should be primary display or select SG for switchable graphics.

Configuration options: [Auto] [IGFX] [PEG]

Internal Graphics [Auto]

This item allows users to enable or disable Internal Graphics. When set to [Auto], it will detect by BIOS. Configuration options: [Auto] [Disabled] [Enabled]

■ VT-d [Enabled]

This item allows users to enable or disable Intel® Virtualization Technology for Directed I/O (VT-d) function.

4.4.2 PCH-IO Configuration

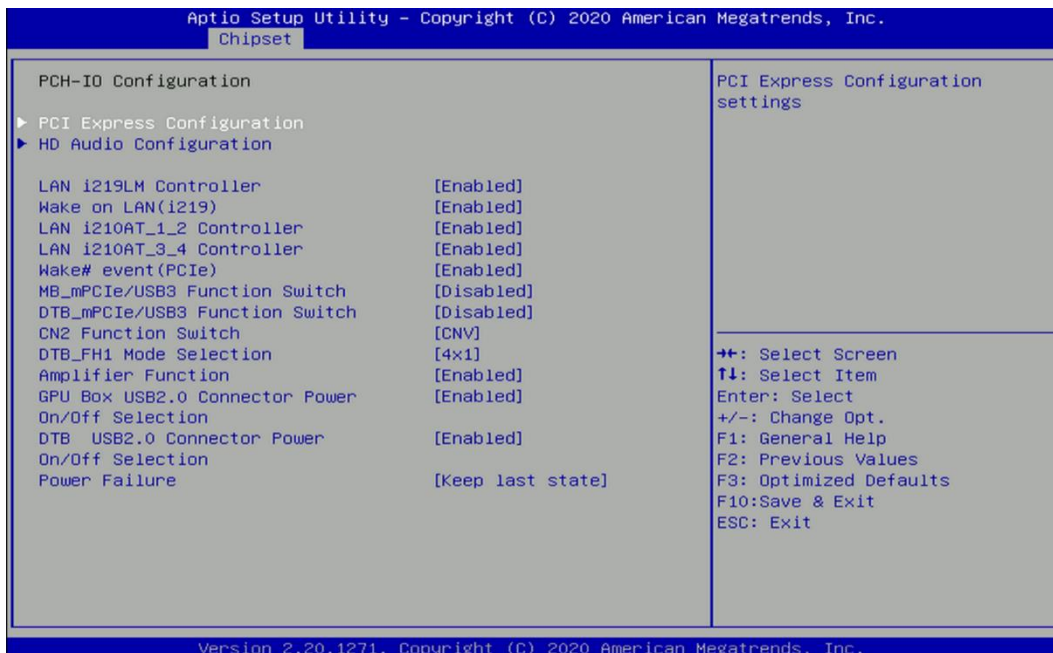

■ PCI Express Configuration



□ PCI Express Root Port (MB_mPCIe)

■ PCI Express Root Port [Enabled]

Allows you to enable or disable the PCI Express Port.

■ PCIe Speed [Auto]

Allows you to select PCI Express interface speed.

Configuration options: [Auto] [Gen1] [Gen2] [Gen3].

- ❑ **PCI Express Root Port (DTB_mPCIe)**
 - **PCI Express Root Port [Enabled]**
Allows you to enable or disable the PCI Express Port.
 - **PCIe Speed [Auto]**
Allows you to select PCI Express interface speed.
Configuration options: [Auto] [Gen1] [Gen2] [Gen3].
- ❑ **PCI Express Root Port (M.2 E Key)**
 - **PCI Express Root Port [Enabled]**
Allows you to enable or disable the PCI Express Port.
 - **PCIe Speed [Auto]**
Allows you to select PCI Express interface speed.
Configuration options: [Auto] [Gen1] [Gen2] [Gen3].

■ HD Audio Configuration

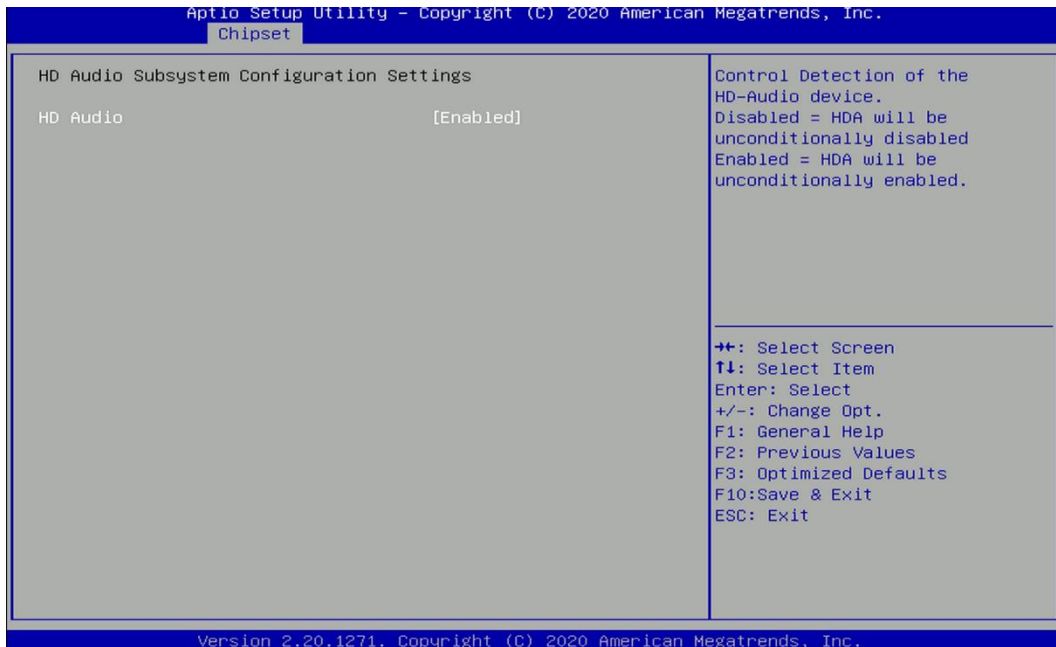

- ❑ **HD Audio [Enabled]**
Allows you to select HD Audio options.
[Enabled]: HD Audio device is unconditionally enabled.
[Disabled]: HD Audio device is unconditionally disabled.

■ LAN i219LM Controller [Enabled]

Enables or disables i219LM LAN Controller.

■ Wake On LAN (i219) [Enabled]

Enables or disables integrated LAN i219LM Wake on LAN function.

■ LAN i210AT_1_2 Controller [Enabled]

Enables or disables I210 LAN Controller.

■ **LAN i210AT_3_4 Controller [Enabled]**

Enables or disables I210 LAN Controller.

■ **Wake# event (PCIe) [Enabled]**

Enables or disables integrated LAN i210 Wake on LAN function.

■ **MB_mPCIe/USB3 Function Switch [Disabled]**

Enables or disables MB_mPCIe/USB3 Controller.

■ **DTB_mPCIe/USB3 Function Switch [Disabled]**

Enables or disables DTB_mPCIe/USB3 Controller.

■ **CN2 Function Switch [CNV]**

Allows users to select [CNV] or [WiFi] for CN2 connector.

■ **DTB_FH1 Mode Selection [4x1]**

Allows users to select [4x1] or [1x4] for DTB_FH1 Mode.

■ **Amplifier Function [Disabled]**

Enables or disables Amplifier Function.

■ **GPU Box USB2.0 Connector Power On/Off Selection [Enabled]**

Enables or disables GPU Box USB2.0 Function.

■ **DTB USB2.0 Connector Power On/Off Selection [Enabled]**

Enables or disables DTB USB2.0 Function.

■ **Power Failure [Keep last state]**

Allows you to specify which power state system will enter when power is resumed after a power failure (G3 state).

[Always on]: Enters to power on state.

[Always off]: Enters to power off state.

[Keep last state]: Enters to the last power state before a power failure.

4.5 Security Setup

This section allows users to configure BIOS security settings.

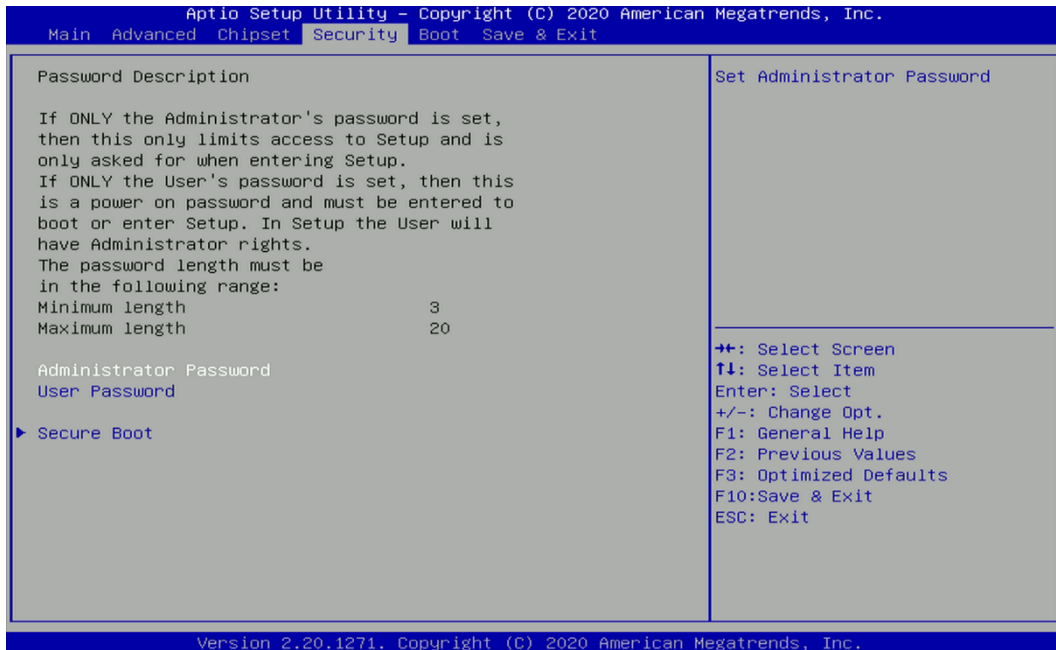

4.5.1 Administrator Password

Administrator Password controls access to the BIOS Setup utility.

4.5.2 User Password

User Password controls access to the system at boot and to the BIOS Setup utility.

4.5.3 Security Boot

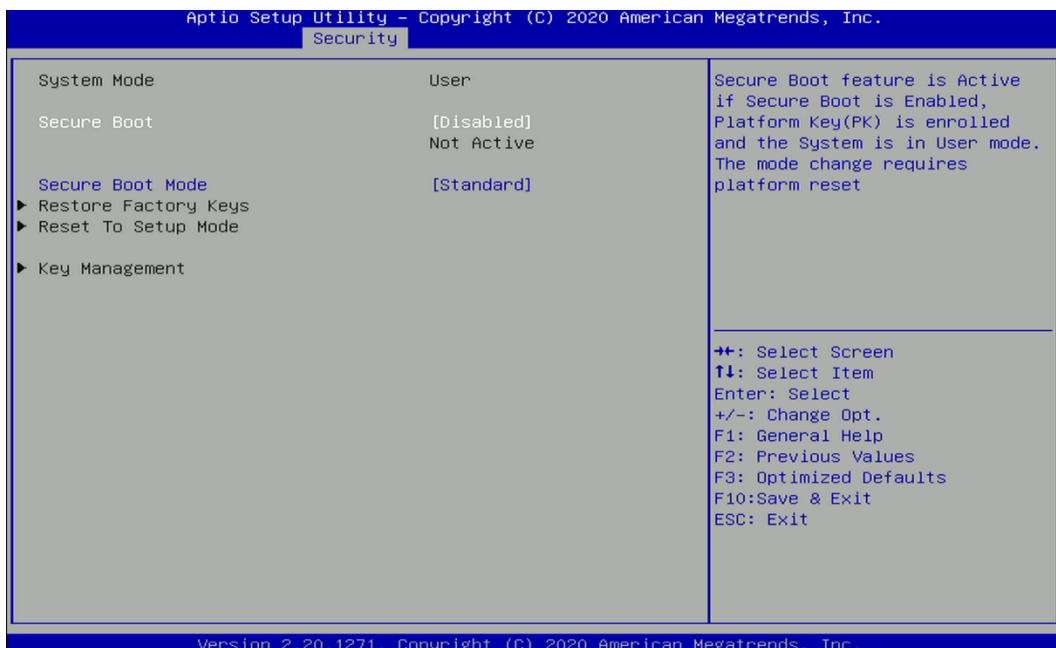

Secure Boot [Disabled]

Enable or disable Secure Boot function.

- ❑ **Secure Boot Mode [Standard]**
Allows you to select Secure Boot Mode.
Configuration options: [Standard] [Custom].

4.6 Boot Setup

This section allows you to configure Boot settings.

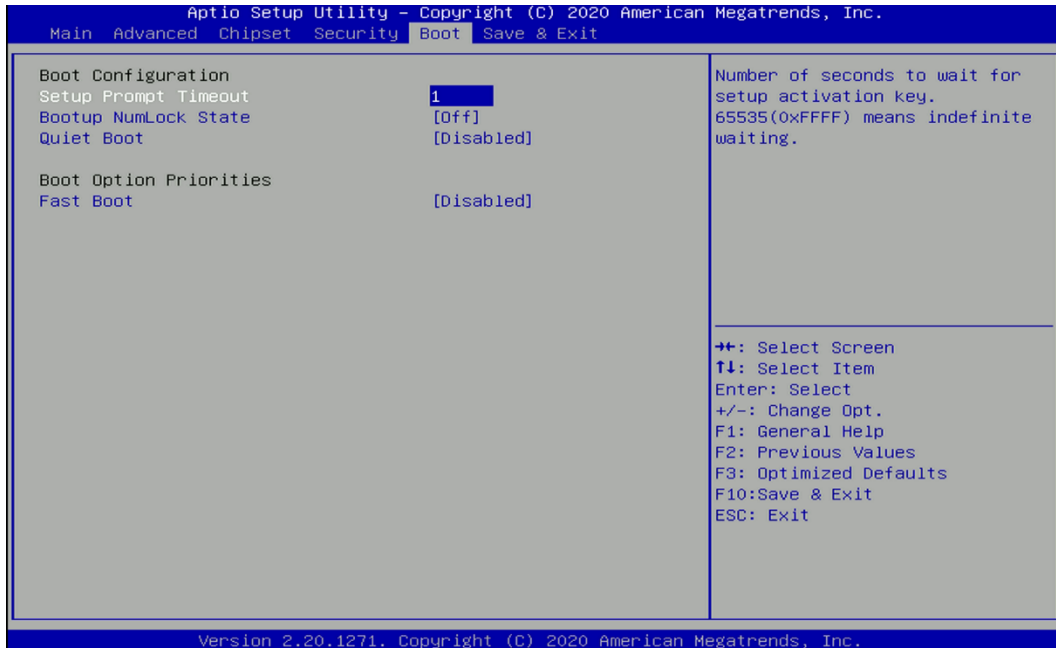

4.6.1 Setup Prompt Timeout [1]

Use this item to set number of seconds (1..65535) to wait for setup activation key.

4.6.2 Bootup NumLock State [Off]

Allows users to select the power-on state for keyboard NumLock.

4.6.3 Quiet Boot [Disabled]

Allows users to enable or disable Quiet Boot function.

4.6.4 Fast Boot [Disabled]

Allows users to enable or disable Fast Boot function.

4.7 Save & Exit

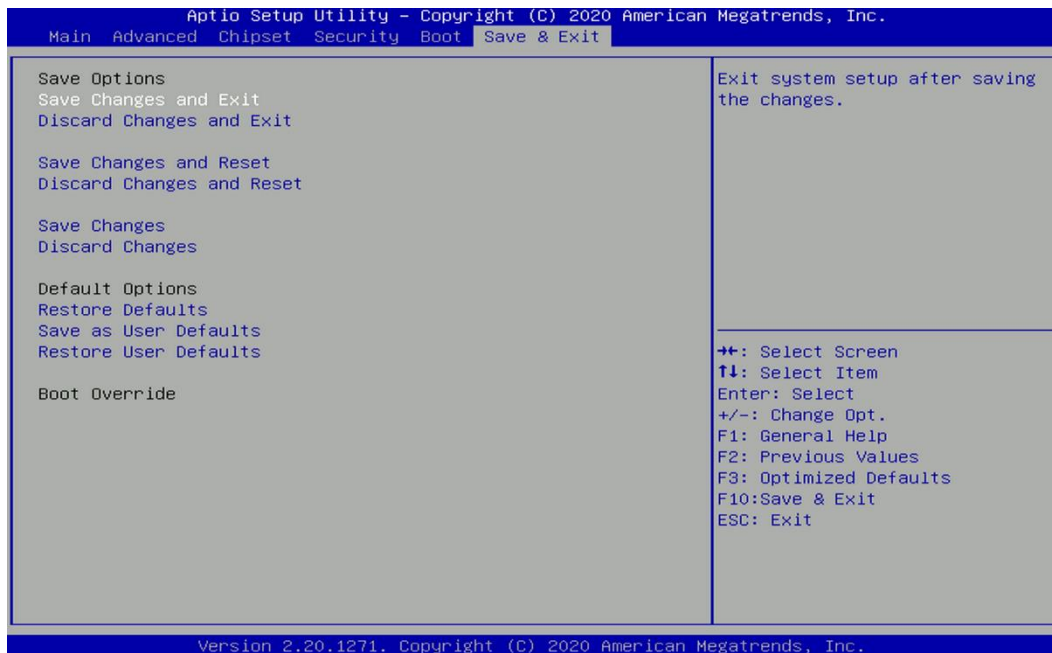

4.7.1 Save Changes and Exit

This item allows users to exit system setup after saving changes.

4.7.2 Discard Changes and Exit

This item allows users to exit system setup without saving changes.

4.7.3 Save Changes and Reset

This item allows users to reset the system after saving changes.

4.7.4 Discard Changes and Reset

This item allows users to reset system setup without saving any changes.

4.7.5 Save Changes

This item allows users to save changes done so far to any of the setup options.

4.7.6 Discard Changes

This item allows users to discard changes done so far to any of the setup options.

4.7.7 Restore Defaults

This item allows users to restore/ load default values for all the options.

4.7.8 Save as User Defaults

This item allows users to save the changes done so far as user defaults.

4.7.9 Restore User Defaults

This item allows users to restore the user defaults to all the options.



Chapter 5

Product Application

5.1 Digital I/O (DIO) application

This section describes DIO application of the product. The content and application development are better understood and implemented by well experienced professionals or developers.

5.1.1 Digital I/O Programming Guide

5.1.1.1 Pins for Digital I/O

Item	Standard
GPIO70 (Pin103)	DI
GPIO71 (Pin104)	
GPIO72 (Pin105)	
GPIO73 (Pin106)	
GPIO74 (Pin107)	
GPIO75 (Pin108)	
GPIO76 (Pin109)	
GPIO77 (Pin110)	
GPIO80 (Pin111)	DO
GPIO81 (Pin112)	
GPIO82 (Pin113)	
GPIO83 (Pin114)	
GPIO84 (Pin115)	
GPIO85 (Pin116)	
GPIO86 (Pin117)	
GPIO87 (Pin118)	

5.1.1.2 Programming Guide

To program the Super I/O chip F81866A configuration registers, the following configuration procedures must be followed in sequence:

- (1) Enter the Extended Function Mode
- (2) Configure the configuration registers
- (3) Exit the Extended Function Mode

The configuration register is used to control the behavior of the corresponding devices. To configure the register, use the index port to select the index and then write data port to alter the parameters. The default index port and data port are 0x4E and 0x4F, respectively.

Pull down the SOUT1 pin to change the default value to 0x2E/ 0x2F. To enable configuration, the entry key 0x87 must be written to the index port. To disable configuration, write exit entry key 0xAA to the index port.

Following is an example to enable configuration and to disable configuration by using debug.

- o 4e 87
- o 4e 87 (enable configuration)
- o 4e aa (disable configuration)

5.1.1.3 Relative Registers

To program the F81866A configuration registers, see the following configuration procedures.

Logic Device Number Register (LDN) — Index 07h

Bit	Name	R/W	Reset	Default	Description
7-0	LDN	R/W	LRESET#	00h	00h: Select FDC device configuration registers. 03h: Select Parallel Port device configuration registers. 04h: Select Hardware Monitor device configuration registers. 05h: Select KBC device configuration registers. 06h: Select GPIO device configuration registers. 07h: Select WDT device configuration registers. 0Ah: Select PME, ACPI and ERP device configuration registers. 10h: Select UART1 device configuration registers. 11h: Select UART2 device configuration registers. 12h: Select UART3 device configuration registers. 13h: Select UART4 device configuration registers. 14h: Select UART5 device configuration registers. 15h: Select UART6 device configuration registers. Otherwise: Reserved.

8.7.13.1GPIO7 Output Enable Register — Index 80h

Bit	Name	R/W	Reset	Default	Description
7	GPIO77_OE	R/W	LRESET#	0	0: GPIO77 is in input mode. 1: GPIO77 is in output mode.
6	GPIO76_OE	R/W	LRESET#	0	0: GPIO76 is in input mode. 1: GPIO76 is in output mode.
5	GPIO75_OE	R/W	LRESET#	0	0: GPIO75 is in input mode. 1: GPIO75 is in output mode.
4	GPIO74_OE	R/W	LRESET#	0	0: GPIO74 is in input mode. 1: GPIO74 is in output mode.
3	GPIO73_OE	R/W	LRESET#	0	0: GPIO73 is in input mode. 1: GPIO73 is in output mode.
2	GPIO72_OE	R/W	LRESET#	0	0: GPIO72 is in input mode. 1: GPIO72 is in output mode.
1	GPIO71_OE	R/W	LRESET#	0	0: GPIO71 is in input mode. 1: GPIO71 is in output mode.
0	GPIO70_OE	R/W	LRESET#	0	0: GPIO70 is in input mode. 1: GPIO70 is in output mode.

8.7.13.3GPIO7 Pin Status Register — Index 82h (This byte could be also read by base address + 3)

Bit	Name	R/W	Reset	Default	Description
7	GPIO77_IN	R	-	-	The pin status of GPIO77/STB#.
6	GPIO76_IN	R	-	-	The pin status of GPIO76/AFD#.
5	GPIO75_IN	R	-	-	The pin status of GPIO75/ERR#.
4	GPIO74_IN	R	-	-	The pin status of GPIO74/INIT#.
3	GPIO73_IN	R	-	-	The pin status of GPIO73/SLIN#.
2	GPIO72_IN	R	-	-	The pin status of GPIO72/ACK#.
1	GPIO71_IN	R	-	-	The pin status of GPIO71/BUSY.
0	GPIO70_IN	R	-	-	The pin status of GPIO70/PE/FANCTL3/PWM_DAC3.

8.7.14.2GPIO8 Output Data Register — Index 89h (This byte could be also written by base address + 2)

Bit	Name	R/W	Reset	Default	Description
7	GPIO87_VAL	R/W	LRESET#	1	0: GPIO87 outputs 0 when in output mode. 1: GPIO87 outputs 1 when in output mode.
6	GPIO86_VAL	R/W	LRESET#	1	0: GPIO86 outputs 0 when in output mode. 1: GPIO86 outputs 1 when in output mode.
5	GPIO85_VAL	R/W	LRESET#	1	0: GPIO85 outputs 0 when in output mode. 1: GPIO85 outputs 1 when in output mode.
4	GPIO84_VAL	R/W	LRESET#	1	0: GPIO84 outputs 0 when in output mode. 1: GPIO84 outputs 1 when in output mode.
3	GPIO83_VAL	R/W	LRESET#	1	0: GPIO83 outputs 0 when in output mode. 1: GPIO83 outputs 1 when in output mode.
2	GPIO82_VAL	R/W	LRESET#	1	0: GPIO82 outputs 0 when in output mode. 1: GPIO82 outputs 1 when in output mode.
1	GPIO81_VAL	R/W	LRESET#	1	0: GPIO81 outputs 0 when in output mode. 1: GPIO81 outputs 1 when in output mode.
0	GPIO80_VAL	R/W	LRESET#	1	0: GPIO80 outputs 0 when in output mode. 1: GPIO80 outputs 1 when in output mode.

8.7.14.1 GPIO8 Output Enable Register — Index 88h

Bit	Name	R/W	Reset	Default	Description
7	GPIO87_OE	R/W	LRESET#	1	0: GPIO87 is in input mode. 1: GPIO87 is in output mode.
6	GPIO86_OE	R/W	LRESET#	1	0: GPIO86 is in input mode. 1: GPIO85 is in output mode.
5	GPIO85_OE	R/W	LRESET#	1	0: GPIO85 is in input mode. 1: GPIO85 is in output mode.
4	GPIO84_OE	R/W	LRESET#	1	0: GPIO84 is in input mode. 1: GPIO84 is in output mode.
3	GPIO83_OE	R/W	LRESET#	1	0: GPIO83 is in input mode. 1: GPIO83 is in output mode.
2	GPIO82_OE	R/W	LRESET#	1	0: GPIO82 is in input mode. 1: GPIO82 is in output mode.
1	GPIO81_OE	R/W	LRESET#	1	0: GPIO81 is in input mode. 1: GPIO81 is in output mode.
0	GPIO80_OE	R/W	LRESET#	1	0: GPIO80 is in input mode. 1: GPIO80 is in output mode.

5.1.1.4 Sample Code in C Language

5.1.1.4.1 Control of GP70 to GP77 (DI1 ~ DI8)

```
#define AddrPort 0x4E
```

```
#define DataPort 0x4F
```

<Enter the Extended Function Mode>

```
WriteByte(AddrPort, 0x87)
```

```
WriteByte(AddrPort, 0x87) // Must write twice to enter Extended mode
```

<Select Logic Device>

```
WriteByte(AddrPort, 0x07)
```

```
WriteByte(dataPort, 0x06) // Select logic device 06h
```

<Output/Input Mode Selection> // Set GP70 to GP77 input Mode

```
WriteByte(AddrPort, 0x80) // Select configuration register 80h
```

```
WriteByte(DataPort, 0x0X) // Set (bit 0~7) = 0 to select GP 70~77 as Input mode.
```

<Input Value>

```
WriteByte(AddrPort, 0x82) // Select configuration register 82h
```

```
ReadByte(DataPort, Value) // Read bit 0~7 (0xFF)= GP70 ~77 as High.
```

<Leave the Extended Function Mode>

```
WriteByte(AddrPort, 0xAA)
```

5.1.1.4.2 Control of GP80 to GP87 (DO1 ~ DO8)

```
#define AddrPort 0x4E
```

```
#define DataPort 0x4F
```

```
<Enter the Extended Function Mode>
```

```
WriteByte(AddrPort, 0x87)
```

```
WriteByte(AddrPort, 0x87) // Must write twice to enter Extended mode
```

```
<Select Logic Device>
```

```
WriteByte(AddrPort, 0x07)
```

```
WriteByte(DataPort, 0x06) // Select logic device 06h
```

```
<Output/Input Mode Selection> // Set GP80 to GP87 output Mode
```

```
WriteByte(AddrPort, 0x88) // Select configuration register 88h
```

```
WriteByte(DataPort, 0xFF) // Set (bit 0~7) = 1 to select GP 80 ~87 as Output mode
```

```
<Output Value>
```

```
WriteByte(AddrPort, 0x89) // Select configuration register 89h
```

```
WriteByte(DataPort, Value) // Set bit 0~7=(0/1) to output GP 80~87 as Low or High
```

```
<Leave the Extended Function Mode>
```

```
WriteByte(AddrPort, 0xAA)
```

5.1.1.5 Change base address

```
<Enter the Extended Function Mode>
```

```
WriteByte(AddrPort, 0x87)
```

```
WriteByte(AddrPort, 0x87) // Must write twice to enter Extended mode
```

```
<Select Logic Device>
```

```
WriteByte(AddrPort, 0x07)
```

```
WriteByte(dataPort, 0x06) // Select logic device 06h
```

```
WriteByte(AddrPort, 0x60)
```

```
// Select configuration register 60h (High Byte address)
```

```
WriteByte(DataPort, (0x0A))
```

```
WriteByte(AddrPort, 0x61)
```

```
// Select configuration register 61h (Low Byte address)
```

```
WriteByte(DataPort, (0x00))
```

```
<Leave the Extended Function Mode>
```

```
WriteByte(AddrPort, 0xAA)
```

Cincoze default GPIO Port base address is 0xA00h

5.1.1.6 DATA Bit Table (DIO)

<table border="1"> <tr><td>7</td><td>6</td><td>5</td><td>4</td><td>3</td><td>2</td><td>1</td><td>0</td><td>bit</td></tr> <tr><td>0</td><td>0</td><td>0</td><td>0</td><td>0</td><td>0</td><td>0</td><td>1</td><td>Value</td></tr> <tr><td colspan="8">1</td><td>/h</td></tr> </table>	7	6	5	4	3	2	1	0	bit	0	0	0	0	0	0	0	1	Value	1								/h	<p>= DI1 (Base address +3) (0xA03)</p>	<table border="1"> <tr><td>7</td><td>6</td><td>5</td><td>4</td><td>3</td><td>2</td><td>1</td><td>0</td><td>bit</td></tr> <tr><td>0</td><td>0</td><td>0</td><td>0</td><td>0</td><td>0</td><td>0</td><td>1</td><td>Value</td></tr> <tr><td colspan="8">1</td><td>/h</td></tr> </table>	7	6	5	4	3	2	1	0	bit	0	0	0	0	0	0	0	1	Value	1								/h	<p>= DO1 (Base address +2) (0xA02)</p>
7	6	5	4	3	2	1	0	bit																																																	
0	0	0	0	0	0	0	1	Value																																																	
1								/h																																																	
7	6	5	4	3	2	1	0	bit																																																	
0	0	0	0	0	0	0	1	Value																																																	
1								/h																																																	
<table border="1"> <tr><td>7</td><td>6</td><td>5</td><td>4</td><td>3</td><td>2</td><td>1</td><td>0</td><td>bit</td></tr> <tr><td>0</td><td>0</td><td>0</td><td>0</td><td>0</td><td>0</td><td>1</td><td>0</td><td>Value</td></tr> <tr><td colspan="8">2</td><td>/h</td></tr> </table>	7	6	5	4	3	2	1	0	bit	0	0	0	0	0	0	1	0	Value	2								/h	<p>= DI2 (Base address +3) (0xA03)</p>	<table border="1"> <tr><td>7</td><td>6</td><td>5</td><td>4</td><td>3</td><td>2</td><td>1</td><td>0</td><td>bit</td></tr> <tr><td>0</td><td>0</td><td>0</td><td>0</td><td>0</td><td>0</td><td>1</td><td>0</td><td>Value</td></tr> <tr><td colspan="8">2</td><td>/h</td></tr> </table>	7	6	5	4	3	2	1	0	bit	0	0	0	0	0	0	1	0	Value	2								/h	<p>= DO2 Base address +2) (0xA02)</p>
7	6	5	4	3	2	1	0	bit																																																	
0	0	0	0	0	0	1	0	Value																																																	
2								/h																																																	
7	6	5	4	3	2	1	0	bit																																																	
0	0	0	0	0	0	1	0	Value																																																	
2								/h																																																	
<table border="1"> <tr><td>7</td><td>6</td><td>5</td><td>4</td><td>3</td><td>2</td><td>1</td><td>0</td><td>bit</td></tr> <tr><td>0</td><td>0</td><td>0</td><td>0</td><td>0</td><td>1</td><td>0</td><td>0</td><td>Value</td></tr> <tr><td colspan="8">4</td><td>/h</td></tr> </table>	7	6	5	4	3	2	1	0	bit	0	0	0	0	0	1	0	0	Value	4								/h	<p>= DI3 (Base address +3) (0xA03)</p>	<table border="1"> <tr><td>7</td><td>6</td><td>5</td><td>4</td><td>3</td><td>2</td><td>1</td><td>0</td><td>bit</td></tr> <tr><td>0</td><td>0</td><td>0</td><td>0</td><td>0</td><td>1</td><td>0</td><td>0</td><td>Value</td></tr> <tr><td colspan="8">4</td><td>/h</td></tr> </table>	7	6	5	4	3	2	1	0	bit	0	0	0	0	0	1	0	0	Value	4								/h	<p>= DO3 Base address +2) (0xA02)</p>
7	6	5	4	3	2	1	0	bit																																																	
0	0	0	0	0	1	0	0	Value																																																	
4								/h																																																	
7	6	5	4	3	2	1	0	bit																																																	
0	0	0	0	0	1	0	0	Value																																																	
4								/h																																																	
<table border="1"> <tr><td>7</td><td>6</td><td>5</td><td>4</td><td>3</td><td>2</td><td>1</td><td>0</td><td>bit</td></tr> <tr><td>0</td><td>0</td><td>0</td><td>0</td><td>1</td><td>0</td><td>0</td><td>0</td><td>Value</td></tr> <tr><td colspan="8">8</td><td>/h</td></tr> </table>	7	6	5	4	3	2	1	0	bit	0	0	0	0	1	0	0	0	Value	8								/h	<p>= DI4 (Base address +3) (0xA03)</p>	<table border="1"> <tr><td>7</td><td>6</td><td>5</td><td>4</td><td>3</td><td>2</td><td>1</td><td>0</td><td>bit</td></tr> <tr><td>0</td><td>0</td><td>0</td><td>0</td><td>1</td><td>0</td><td>0</td><td>0</td><td>Value</td></tr> <tr><td colspan="8">8</td><td>/h</td></tr> </table>	7	6	5	4	3	2	1	0	bit	0	0	0	0	1	0	0	0	Value	8								/h	<p>= DO4 Base address +2) (0xA02)</p>
7	6	5	4	3	2	1	0	bit																																																	
0	0	0	0	1	0	0	0	Value																																																	
8								/h																																																	
7	6	5	4	3	2	1	0	bit																																																	
0	0	0	0	1	0	0	0	Value																																																	
8								/h																																																	
<table border="1"> <tr><td>7</td><td>6</td><td>5</td><td>4</td><td>3</td><td>2</td><td>1</td><td>0</td><td>bit</td></tr> <tr><td>0</td><td>0</td><td>0</td><td>1</td><td>0</td><td>0</td><td>0</td><td>0</td><td>Value</td></tr> <tr><td colspan="8">10</td><td>/h</td></tr> </table>	7	6	5	4	3	2	1	0	bit	0	0	0	1	0	0	0	0	Value	10								/h	<p>= DI5 (Base address +3) (0xA03)</p>	<table border="1"> <tr><td>7</td><td>6</td><td>5</td><td>4</td><td>3</td><td>2</td><td>1</td><td>0</td><td>bit</td></tr> <tr><td>0</td><td>0</td><td>0</td><td>1</td><td>0</td><td>0</td><td>0</td><td>0</td><td>Value</td></tr> <tr><td colspan="8">10</td><td>/h</td></tr> </table>	7	6	5	4	3	2	1	0	bit	0	0	0	1	0	0	0	0	Value	10								/h	<p>= DO5 Base address +2) (0xA02)</p>
7	6	5	4	3	2	1	0	bit																																																	
0	0	0	1	0	0	0	0	Value																																																	
10								/h																																																	
7	6	5	4	3	2	1	0	bit																																																	
0	0	0	1	0	0	0	0	Value																																																	
10								/h																																																	
<table border="1"> <tr><td>7</td><td>6</td><td>5</td><td>4</td><td>3</td><td>2</td><td>1</td><td>0</td><td>bit</td></tr> <tr><td>0</td><td>0</td><td>1</td><td>0</td><td>0</td><td>0</td><td>0</td><td>0</td><td>Value</td></tr> <tr><td colspan="8">20</td><td>/h</td></tr> </table>	7	6	5	4	3	2	1	0	bit	0	0	1	0	0	0	0	0	Value	20								/h	<p>= DI6 (Base address +3) (0xA03)</p>	<table border="1"> <tr><td>7</td><td>6</td><td>5</td><td>4</td><td>3</td><td>2</td><td>1</td><td>0</td><td>bit</td></tr> <tr><td>0</td><td>0</td><td>1</td><td>0</td><td>0</td><td>0</td><td>0</td><td>0</td><td>Value</td></tr> <tr><td colspan="8">20</td><td>/h</td></tr> </table>	7	6	5	4	3	2	1	0	bit	0	0	1	0	0	0	0	0	Value	20								/h	<p>= DO6 Base address +2) (0xA02)</p>
7	6	5	4	3	2	1	0	bit																																																	
0	0	1	0	0	0	0	0	Value																																																	
20								/h																																																	
7	6	5	4	3	2	1	0	bit																																																	
0	0	1	0	0	0	0	0	Value																																																	
20								/h																																																	
<table border="1"> <tr><td>7</td><td>6</td><td>5</td><td>4</td><td>3</td><td>2</td><td>1</td><td>0</td><td>bit</td></tr> <tr><td>0</td><td>1</td><td>0</td><td>0</td><td>0</td><td>0</td><td>0</td><td>0</td><td>Value</td></tr> <tr><td colspan="8">40</td><td>/h</td></tr> </table>	7	6	5	4	3	2	1	0	bit	0	1	0	0	0	0	0	0	Value	40								/h	<p>= DI7 (Base address +3) (0xA03)</p>	<table border="1"> <tr><td>7</td><td>6</td><td>5</td><td>4</td><td>3</td><td>2</td><td>1</td><td>0</td><td>bit</td></tr> <tr><td>0</td><td>1</td><td>0</td><td>0</td><td>0</td><td>0</td><td>0</td><td>0</td><td>Value</td></tr> <tr><td colspan="8">40</td><td>/h</td></tr> </table>	7	6	5	4	3	2	1	0	bit	0	1	0	0	0	0	0	0	Value	40								/h	<p>= DO7 Base address +2) (0xA02)</p>
7	6	5	4	3	2	1	0	bit																																																	
0	1	0	0	0	0	0	0	Value																																																	
40								/h																																																	
7	6	5	4	3	2	1	0	bit																																																	
0	1	0	0	0	0	0	0	Value																																																	
40								/h																																																	

7	6	5	4	3	2	1	0	bit
1	0	0	0	0	0	0	0	Value
80								/h

= DI8
(Base
address +3)
(0xA03)

7	6	5	4	3	2	1	0	bit
1	0	0	0	0	0	0	0	Value
80								/h

= DO8
Base address
+2) (0xA02)

3.7.2.1 DIO I/O Port Address (Default Address 0xA00)

DI8	DI7	DI6	DI5	DI4	DI3	DI2	DI1	DO8	DO7	DO6	DO5	DO4	DO3	DO2	DO1	Pin Definition
7	6	5	4	3	2	1	0	7	6	5	4	3	2	1	0	Data Bits
DI								DO								DIO
0xA03								0xA02								I/O Port address

5.2 DIO Hardware Specification

- XCOM+: Isolated power in V+
- XCOM-: Isolated power in V-
- Isolated power in DC voltage: 9~30V
- 8x Digital Input (Source Type)
- Input Signal Voltage Level
 - Signal Logic 0: XCOM+ = 9V, Signal Low - V- < 1V
XCOM+ > 9V, V+ - Signal Low > 8V
 - Signal Logic 1: > XCOM+ - 3V
- Input Driving Sink Current:
 - Minimal: 1 mA
 - Normal: 5 mA
- 8x Digital Output (Open Drain)
 - DO Signal have to pull up resistor to XCOM+ for external device, the resistance will affect the pull up current
 - Signal High Level: Pull up resistor to XCOM+
 - Signal Low Level: = XCOM-
 - Sink Current: 1A (Max)

5.2.1 DIO Connector Definition

DIO1/DIO2: Digital Input / Output Connector

Connector Type: Terminal Block 2X10 10-pin, 3.5mm pitch

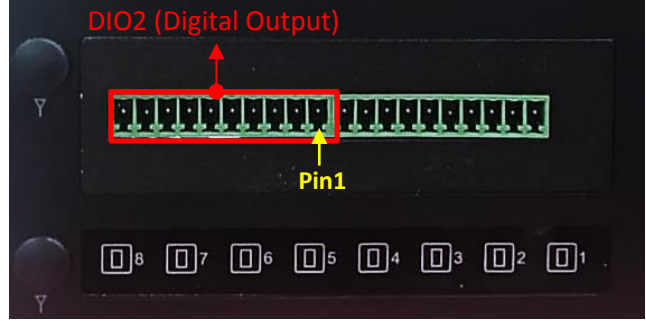
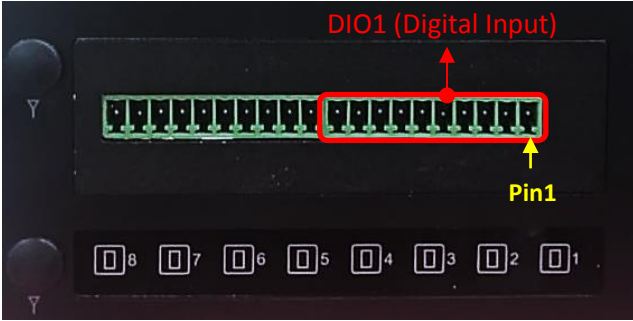

Location	Pin	Definition
DIO1	1	DC INPUT (XCOM+)
	2	DI1
	3	DI2
	4	DI3
	5	DI4
	6	DI5
	7	DI6
	8	DI7
	9	DI8
	10	GND (XCOM-)

Location	Pin	Definition
DIO2	1	DC INPUT (XCOM+)
	2	DO1
	3	DO2
	4	DO3
	5	DO4
	6	DO5
	7	DO6
	8	DO7
	9	DO8
	10	GND (XCOM-)

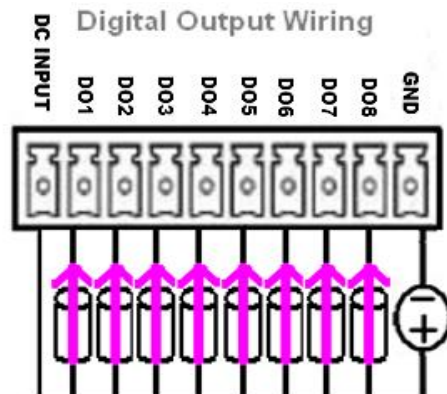
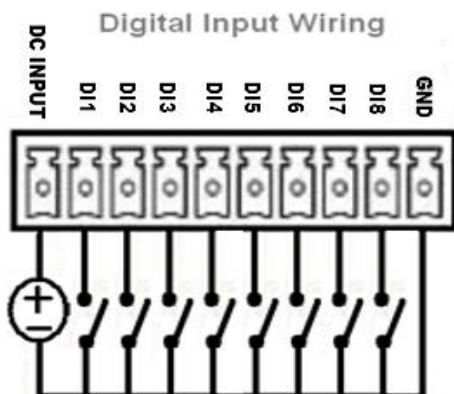

Reference Input Circuit

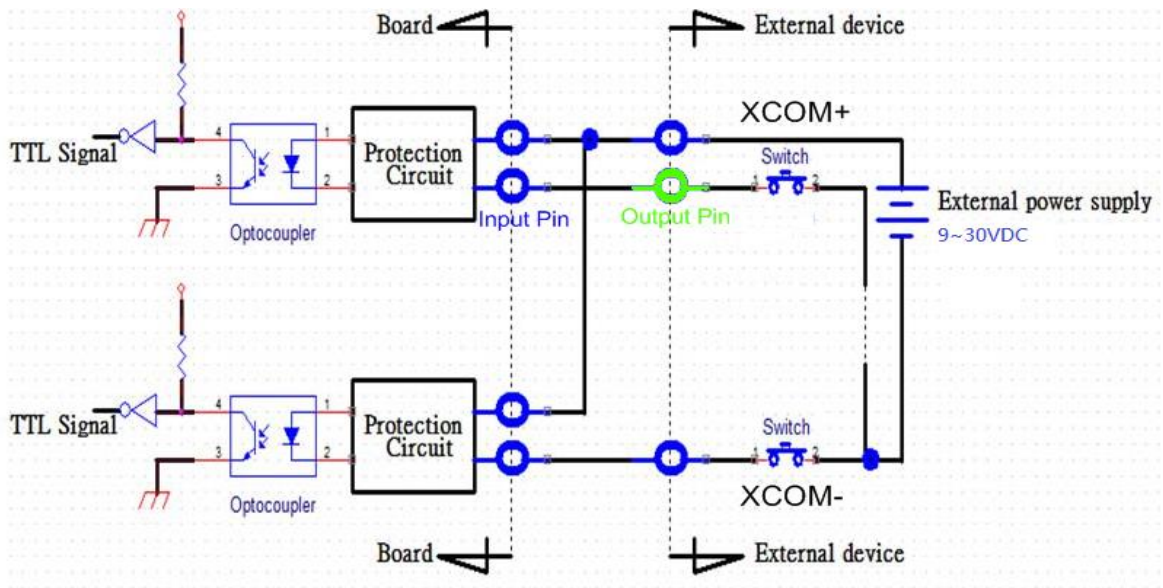

Reference Output Circuit

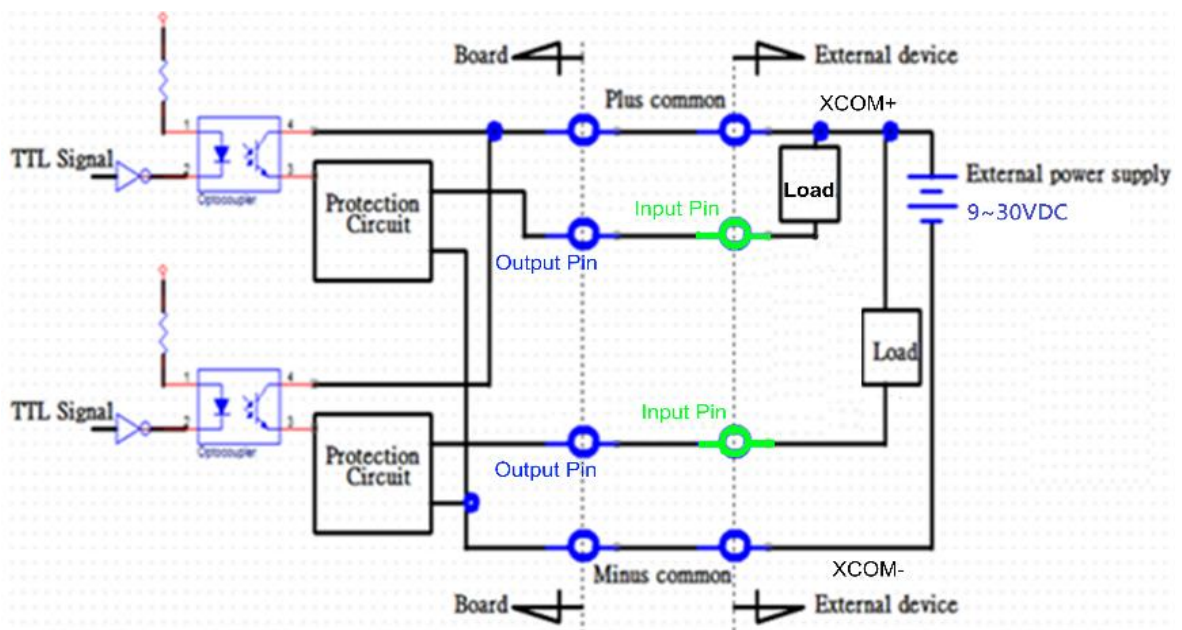

5.3 GPIO LED application

This section describes GPIO LED application of the product. The content and application development are better understood and implemented by well experienced professionals or developers.

5.3.1 GPIO LED Programming Guide

5.3.1.1 Pins for GPIO LED



Item	GPIO LED
GPIO 50	LED1
GPIO 51	LED2
GPIO 52	LED3
GPIO 53	LED4
GPIO 54	LED5
GPIO 55	LED6
GPIO 56	LED7
GPIO 57	LED8



Item	GPIO LED
GPIO 10	LED ON/OFF

5.3.1.2 Programming Guide

To program the Super I/O chip F81866A configuration registers, the following configuration procedures must be followed in sequence:

- (1) Enter the Extended Function Mode
- (2) Configure the configuration registers
- (3) Exit the Extended Function Mode

The configuration register is used to control the behavior of the corresponding devices. To configure the register, use the index port to select the index and then write data port to alter the parameters. The default index port and data port are 0x4E and 0x4F, respectively.

Pull down the SOUT1 pin to change the default value to 0x2E/ 0x2F. To enable configuration, the entry key 0x87 must be written to the index port. To disable configuration, write exit entry key 0xAA to the index port.

Following is examples to enable configuration and to disable configuration by using debug.

Example to enable configuration:

```
-o 4e 87
```

```
-o 4e 87
```

Example to disable configuration:

```
-o 4e aa
```

5.3.1.3 Relative Registers

To program the F81866A configuration registers, see the following configuration procedures.

Logic Device Number Register (LDN) — Index 07h

Bit	Name	R/W	Reset	Default	Description
7-0	LDN	R/W	LRESET#	00h	00h: Select FDC device configuration registers. 03h: Select Parallel Port device configuration registers. 04h: Select Hardware Monitor device configuration registers. 05h: Select KBC device configuration registers. 06h: Select GPIO device configuration registers. 07h: Select WDT device configuration registers. 0Ah: Select PME, ACPI and ERP device configuration registers. 10h: Select UART1 device configuration registers. 11h: Select UART2 device configuration registers. 12h: Select UART3 device configuration registers. 13h: Select UART4 device configuration registers. 14h: Select UART5 device configuration registers. 15h: Select UART6 device configuration registers. Otherwise: Reserved.

Following is an example to Select GPIO device by LDN(index 07h) using debug.

```
-o 4e 07
-o 4f 06
```

Relative Registers for GPIO LED1~LED8 (GPIO5x)

GPIO5 Output Enable Register — Index A0h

Bit	Name	R/W	Reset	Default	Description
7	GPIO57_OE	R/W	LRESET#	0	0: GPIO57 is in input mode. 1: GPIO57 is in output mode.
6	GPIO56_OE	R/W	LRESET#	0	0: GPIO56 is in input mode. 1: GPIO56 is in output mode.
5	GPIO55_OE	R/W	LRESET#	0	0: GPIO55 is in input mode. 1: GPIO55 is in output mode.
4	GPIO54_OE	R/W	LRESET#	0	0: GPIO54 is in input mode. 1: GPIO54 is in output mode.
3	GPIO53_OE	R/W	LRESET#	0	0: GPIO53 is in input mode. 1: GPIO53 is in output mode.
2	GPIO52_OE	R/W	LRESET#	0	0: GPIO52 is in input mode. 1: GPIO52 is in output mode.
1	GPIO51_OE	R/W	LRESET#	0	0: GPIO51 is in input mode. 1: GPIO51 is in output mode.
0	GPIO50_OE	R/W	LRESET#	0	0: GPIO50 is in input mode. 1: GPIO50 is in output mode.

Following example to set output enable for GPIO50~GPIO57 (LED1~LED8) by using debug.

```
-o 4e a0
```

```
-o 4f ff
```

GPIO5 Output Data Register — Index A1h (This byte could be also written by base address + 5)

Bit	Name	R/W	Reset	Default	Description
7	GPIO57_DATA	R/W	LRESET#	1	0: GPIO57 outputs 0 when in output mode. 1: GPIO57 outputs 1 when in output mode.
6	GPIO56_DATA	R/W	LRESET#	1	0: GPIO56 outputs 0 when in output mode. 1: GPIO56 outputs 1 when in output mode.
5	GPIO55_DATA	R/W	LRESET#	1	0: GPIO55 outputs 0 when in output mode. 1: GPIO55 outputs 1 when in output mode.
4	GPIO54_DATA	R/W	LRESET#	1	0: GPIO54 outputs 0 when in output mode. 1: GPIO54 outputs 1 when in output mode.
3	GPIO53_DATA	R/W	LRESET#	1	0: GPIO53 outputs 0 when in output mode. 1: GPIO53 outputs 1 when in output mode.
2	GPIO52_DATA	R/W	LRESET#	1	0: GPIO52 outputs 0 when in output mode. 1: GPIO52 outputs 1 when in output mode.
1	GPIO51_DATA	R/W	LRESET#	1	0: GPIO51 outputs 0 when in output mode. 1: GPIO51 outputs 1 when in output mode.
0	GPIO50_DATA	R/W	LRESET#	1	0: GPIO50 outputs 0 when in output mode. 1: GPIO50 outputs 1 when in output mode.

Following example to set output data for GPIO50~GPIO57 (LED1~LED8) by using debug.

-o 4e a1

-o 4f ff (Note: the data value can set with range 0 to ff)

Relative Registers for GPIO LED ON/OFF (GPIO10)

GPIO1 Output Enable Register — Index E0h

Bit	Name	R/W	Reset	Default	Description
7	GPIO17_OE	R/W	5VSB	0	0: GPIO17 is in input mode. 1: GPIO17 is in output mode.
6	GPIO16_OE	R/W	5VSB	0	0: GPIO16 is in input mode. 1: GPIO16 is in output mode.
5	GPIO15_OE	R/W	5VSB	0	0: GPIO15 is in input mode. 1: GPIO15 is in output mode.
4	GPIO14_OE	R/W	5VSB	0	0: GPIO14 is in input mode. 1: GPIO14 is in output mode.
3	GPIO13_OE	R/W	5VSB	0	0: GPIO13 is in input mode. 1: GPIO13 is in output mode.
2	GPIO12_OE	R/W	5VSB	0	0: GPIO12 is in input mode. 1: GPIO12 is in output mode.
1	GPIO11_OE	R/W	5VSB	0	0: GPIO11 is in input mode. 1: GPIO11 is in output mode.
0	GPIO10_OE	R/W	5VSB	0	0: GPIO10 is in input mode. 1: GPIO10 is in output mode.

Following example to set output enable for GPIO10 (LED ON/OFF) by using debug.

First step, read the original value from output enable register (index E0)

```
-o 4e e0
```

```
-l 4f
```

00 (Note: This is for example, we pretend to get original value is 00)

Because we need to set bit0 to 1 for GPIO10 output, thus made the new value to 01.

Second step, write the new value 01 to set bit0 with output mode

```
-o 4e e0
```

```
-o 4f 01
```

GPIO1 Output Data Register — Index E1h (This byte could be also written by base address + 7)

Bit	Name	R/W	Reset	Default	Description
7	GPIO17_VAL	R/W	5VSB	1	0: GPIO17 outputs 0 when in output mode. 1: GPIO17 outputs 1 when in output mode.
6	GPIO16_VAL	R/W	5VSB	1	0: GPIO16 outputs 0 when in output mode. 1: GPIO16 outputs 1 when in output mode.
5	GPIO15_VAL	R/W	5VSB	1	0: GPIO15 outputs 0 when in output mode. 1: GPIO15 outputs 1 when in output mode.
4	GPIO14_VAL	R/W	5VSB	1	0: GPIO14 outputs 0 when in output mode. 1: GPIO14 outputs 1 when in output mode.
3	GPIO13_VAL	R/W	5VSB	1	0: GPIO13 outputs 0 when in output mode. 1: GPIO13 outputs 1 when in output mode.
2	GPIO12_VAL	R/W	5VSB	1	0: GPIO12 outputs 0 when in output mode. 1: GPIO12 outputs 1 when in output mode.
1	GPIO11_VAL	R/W	5VSB	1	0: GPIO11 outputs 0 when in output mode. 1: GPIO11 outputs 1 when in output mode.
0	GPIO10_VAL	R/W	5VSB	1	0: GPIO10 outputs 0 when in output mode. 1: GPIO10 outputs 1 when in output mode.

Following example to set output data for GPIO10 (LED ON/OFF) by using debug.

First step, read the original value from output enable register (index E1)

```
-o 4e e1
```

```
-l 4f
```

```
00 (Note: This is for example, we pretend to get original value is 00)
```

Because we need to set bit0 to 1 for GPIO10 output data, thus made the new value to 01.

Second step: write the new value 01 to set bit0 with output drive with push pull

```
-o 4e e1
```

```
-o 4f 01 ( Note, the bit0 (GPIO10) can be set 0 or 1)
```

5.3.1.4 Sample Code in C Language

5.3.1.4.1 Control of GPIO50 to GPIO57 (LED1~ LED8)



```
#define AddrPort 0x4E
#define DataPort 0x4F

<Enter the Extended Function Mode>
WriteByte(AddrPort, 0x87)
WriteByte(AddrPort, 0x87)           // Must write twice to enter Extended mode

<Select Logic Device>
WriteByte(AddrPort, 0x07)
WriteByte(DataPort, 0x06)         // Select logic device 06h

<Output/Input Mode Selection>     // Set GPIO 50~57 to output mode
WriteByte(AddrPort, 0xA0)         // Select configuration register A0h
WriteByte(DataPort, 0xFF)        // Set (bit 0~7) = 1 to select GPIO 50~57 as output
mode.

<Output Value>
WriteByte(AddrPort, 0xA1)         // Select configuration register A1h
Value = 0xFF                     // Set Value with range 00h~FFh
WriteByte(DataPort, Value)       // Set bit 0~7=(0/1) to output GPIO 50~57 as Low or
High

<Leave the Extended Function Mode>
WriteByte(AddrPort, 0xAA)
```

5.3.1.4.2 Control of GPIO10 (LED ON/OFF)

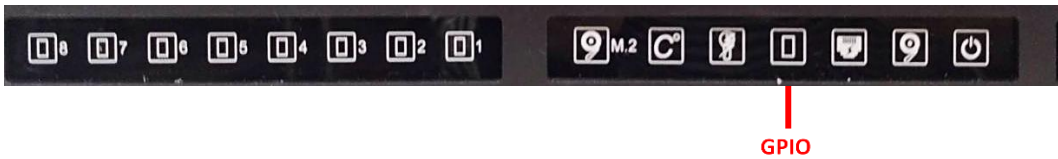

```
#define AddrPort 0x4E
#define DataPort 0x4F

<Enter the Extended Function Mode>
WriteByte(AddrPort, 0x87)
WriteByte(AddrPort, 0x87)           // Must write twice to enter Extended mode

<Select Logic Device>
WriteByte(AddrPort, 0x07)
WriteByte(DataPort, 0x06)           // Select logic device 06h

<Output/Input Mode Selection>       // Set GPIO10 to output Mode
WriteByte(AddrPort, 0xE0)           // Select configuration register E0h
Value=ReadByte(DataPort)           //Read Original Value from register E0h
WriteByte(AddrPort, 0xE0)           // Select configuration register E0h
WriteByte(DataPort, Value | 0x01)   // Set (bit 0) = 1 to select GPIO10 as output mode

<Output Value>

WriteByte(AddrPort, 0xE1)           // Select configuration register E1h
Value=ReadByte(DataPort)           //Read Original Value from register E1h

WriteByte(AddrPort, 0xE1)           // Select configuration register E1h
WriteByte(DataPort, Value & 0xFE ) // Set (bit 0) =0 to output GPIO10 as Low

WriteByte(AddrPort, 0xE1)           // Select configuration register E1h
WriteByte(DataPort, Value | 0x01 ) // Set (bit 0) =1 to output GPI10 as High

<Leave the Extended Function Mode>
WriteByte(AddrPort, 0xAA)
```

5.3.1.5 Change base address

Cincoze default GPIO Port base address is 0xA00

Base Address High Register — Index 60h

Bit	Name	R/W	Reset	Default	Description
7-0	GP_BASE_ADDR_HI	R/W	LRESET#	00h	The MSB of GPIO I/O port address.

Base Address Low Register — Index 61h

Bit	Name	R/W	Reset	Default	Description
7-0	BASE_ADDR_LO	R/W	LRESET#	00h	<p>The LSB of KBC data port address. When GPIO_DEC_RANGE is "0", only 8 bytes are decoded:</p> <p>Base + 0: index port. Base + 1: data port. Base + 2: GPIO8 data register. Base + 3: GPIO7 data register. Base + 4: GPIO6 data register. Base + 5: GPIO5 data register. Base + 6: GPIO0 data register. Base + 7: GPIO1 data register.</p> <p>If GPIO_DEC_RANGE is set to "1", more 8 bytes are decoded:</p> <p>Base + 8: GPIO2 data register. Base + 9: GPIO3 data register. Base + 10: GPIO4 data register.</p> <p>Otherwise: Reserved.</p> <p>There are three ways to access the GPIO registers.</p> <ol style="list-style-type: none"> 1. Use configuration register port 0x4E/0x4F (or 0x2E/0x2F), the LDN for GPIO is 0x06. 2. Use GPIO index/data port. Write index to index port first and then read/write the register. 3. Use digital I/O port. The way only access GPIO data register. Write data to this port will control the data output register. And read this port will read the pin status register.

<Enter the Extended Function Mode>

WriteByte(AddrPort, 0x87)

WriteByte(AddrPort, 0x87) // Must write twice to enter Extended mode

<Select Logic Device>

WriteByte(AddrPort, 0x07)

WriteByte(dataPort, 0x06) // Select logic device 06h

```
WriteByte(AddrPort, 0x60) // Select configuration register 60h (High Byte address)
WriteByte(DataPort, (0x0A))
```

```
WriteByte(AddrPort, 0x61) // Select configuration register 61h (Low Byte address)
WriteByte(DataPort, (0x00))
```

<Leave the Extended Function Mode>
 WriteByte(AddrPort, 0xAA)

5.3.1.6 DATA Bit Table

GPIO-LED LED1~LED8 (GPIO5x)

I/O Port data register address = Base address + 5 = 0xA05

7	6	5	4	3	2	1	0	bit	= LED1
0	0	0	0	0	0	0	1	Value	(Base address +5)
1								/h	(0xA05)

7	6	5	4	3	2	1	0	bit	= LED2
0	0	0	0	0	0	1	0	Value	(Base address +5)
2								/h	(0xA05)

7	6	5	4	3	2	1	0	bit	= LED3
0	0	0	0	0	1	0	0	Value	(Base address +5)
4								/h	(0xA05)

7	6	5	4	3	2	1	0	bit	= LED4
0	0	0	0	1	0	0	0	Value	(Base address +5)
8								/h	(0xA05)

7	6	5	4	3	2	1	0	bit	= LED5
0	0	0	1	0	0	0	0	Value	(Base address +5)
10								/h	(0xA05)

7	6	5	4	3	2	1	0	bit	= LED6 (Base address +5) (0xA05)
0	0	1	0	0	0	0	0	Value	
20								/h	

7	6	5	4	3	2	1	0	bit	= LED7 (Base address +5) (0xA05)
0	1	0	0	0	0	0	0	Value	
40								/h	

7	6	5	4	3	2	1	0	bit	= LED 8 (Base address +5) (0xA05)
1	0	0	0	0	0	0	0	Value	
80								/h	

GPIO-LED LED ON/OFF (GPIO10)

I/O Port data register address = Base address + 5 = 0xA07

7	6	5	4	3	2	1	0	bit	= DO0 (Base address +7) (0xA07)
0	0	0	0	0	0	0	1	Value	
1								/h	

5.4 GPIO LED Status Definition



LED Type	Status	LED Color
GPIO LED	GPIO activity	Green
	No activity	Off



Chapter 6

Optional Modules & Accessories

6.1 Optional Module Pin Definition & Settings

6.1.1 CMI-M12LAN01-R12/UB1410 Module

CMI-M12 LAN Module Pin Definitions

Connector Type: M12 A coded 8pin connector

Pin	Definition	Pin	Definition
1	2_LAN1_0+	2	2_LAN1_0-
3	2_LAN1_1+	4	2_LAN1_2+
5	2_LAN1_2-	6	2_LAN1_1-
7	2_LAN1_3+	8	2_LAN1_3-

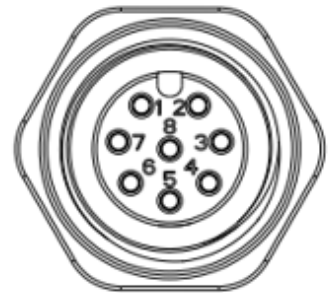

6.1.2 CMI-XM12LAN01-R10/UB1410 Module

CMI-XM12LAN01 Module Pin Definitions

Connector Type: M12 X coded 8pin connector

Pin	Definition	Pin	Definition
1	D1+	2	D1-
3	D2+	4	D2-
5	D4+	6	D4-
7	D3-	8	D3+

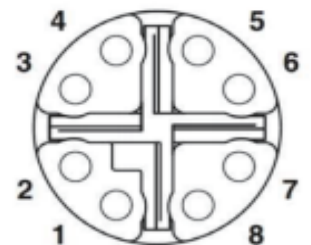

6.1.3 CMI-COM04-R10/UB1403 Module

COM3 / COM4 : RS232 / RS422 / RS485 Connector

Connector Type: 9-pin D-Sub

Pin	RS232 Definition	RS422 / 485 Full Duplex Definition	RS485 Half Duplex Definition
1	DCD	TX-	DATA -
2	RXD	TX+	DATA +
3	TXD	RX+	
4	DTR	RX-	
5	GND		
6	DSR		
7	RTS		
8	CTS		
9	RI		



SW2 on CMI-COM Module : COM3 / COM4 Power Select

Location	Function	DIP1	DIP2
SW2	COM3	0V(RI)	ON (Default)
		5V	ON
		12V	OFF

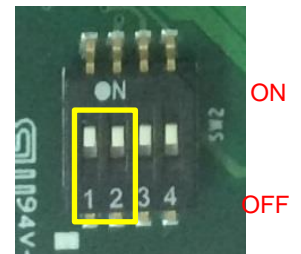

Location	Function	DIP3	DIP4
SW2	COM4	0V(RI)	ON (Default)
		5V	ON
		12V	OFF

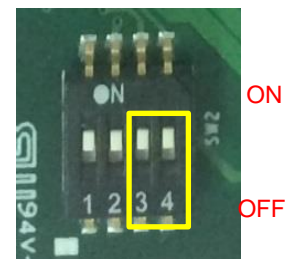

6.1.4 CFM-IGN03-R11 Module

SW1_1 : IGN Module Timing Setting Switch

Set shutdown delay timer when ACC is turned off

Pin 1	Pin 2	Pin 3	Pin 4	Definition
ON (IGN Enabled) OFF (IGN Disabled)	ON	ON	ON	0 second
	ON	ON	OFF	1 minute
	ON	OFF	ON	5 minutes
	ON	OFF	OFF	10 minutes
	OFF	ON	ON	30 minutes
	OFF	ON	OFF	1 hour
	OFF	OFF	ON	2 hours
	OFF	OFF	OFF	Reserved (0 second)

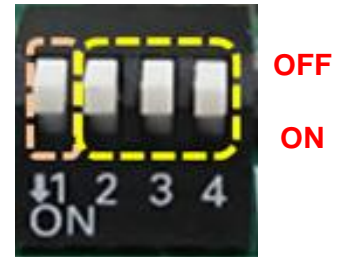

Default setting of Pin1 to Pin4 is OFF / OFF / OFF / OFF.

24V_12V_1 : IGN Module Voltage Mode Setting Switch

12V / 24V Car Battery Switch

Switch	Definition
Left	12V Car Battery Input
Right	24V Car Battery Input (Default)



6.1.5 GEB-3301-R10 Module

6.1.4.1 Location of Switches and Connectors

Top View

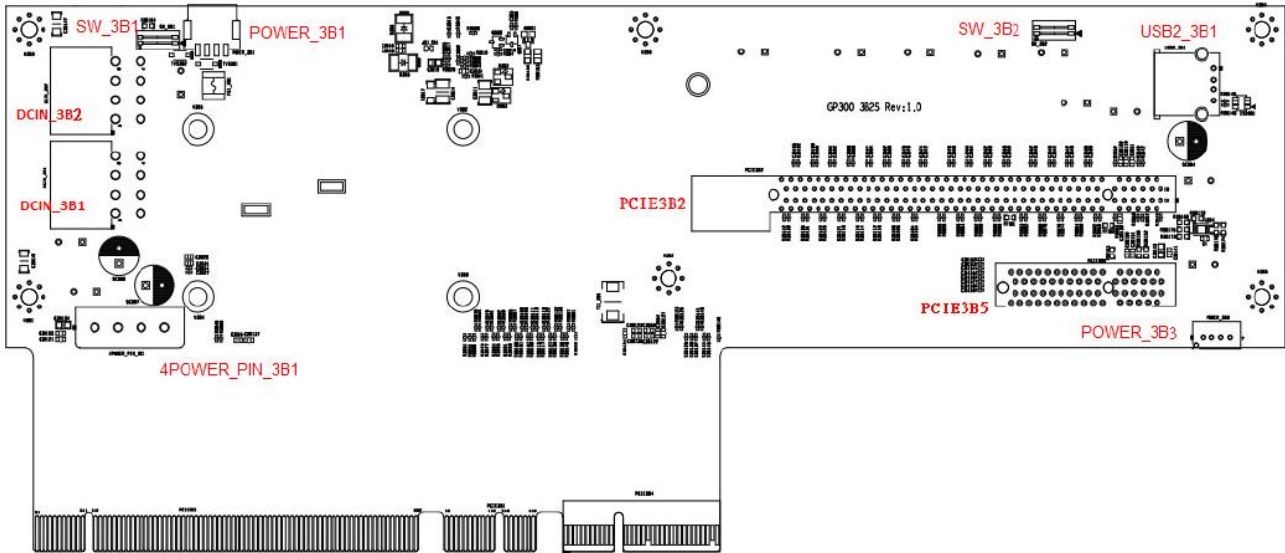

Bottom View

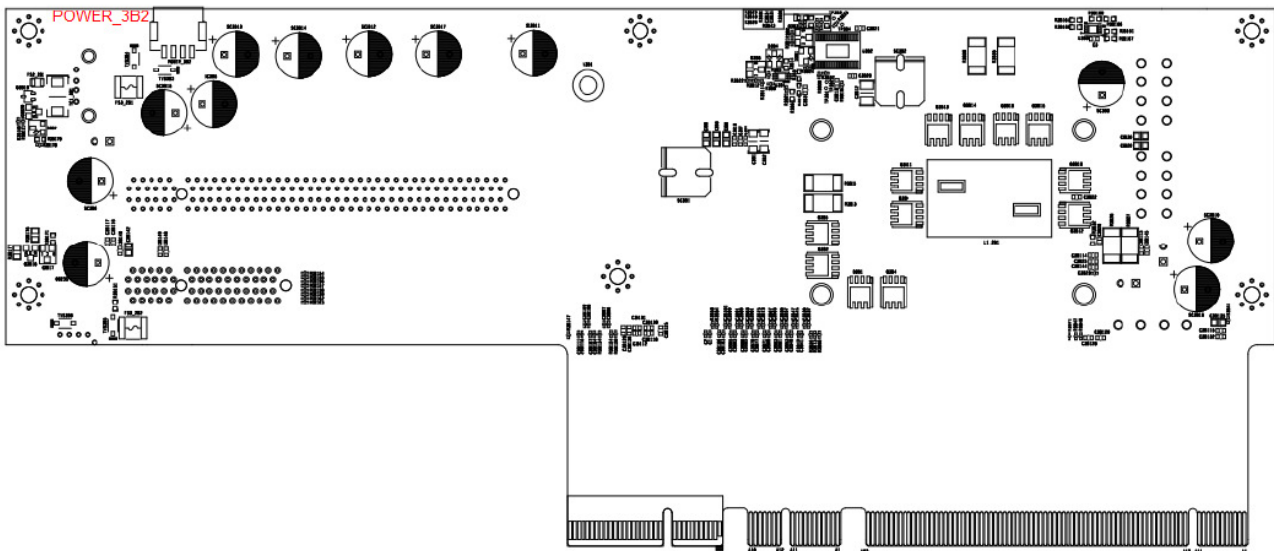

6.1.4.2 Switches and Connectors Definition

List of Switches and Connectors

Location	Definition
4POWER_PIN_3B1	Power pin connector for Graphic card 4 power pin
DCIN_3B1	Power pin connector for Graphic card 8+8 power pin
DCIN_3B2	Power pin connector for Graphic card 8+8 power pin
PCIE3B2	Standard PCIe16 slot
PCIE3B5	Standard PCIe4 slot
POWER_3B1	Fan power connector
POWER_3B2	Fan power connector
POWER_3B3	Fan power connector
SW_3B1	Smart Fan on/off switch (for POWER_3B1)
SW_3B2	Smart Fan on/off switch (for POWER_3B2 & POWER_3B3)
USB2_3B1	Standard USB 2.0 connector

6.1.4.3 Definition of Switches and Connectors

4POWER_PIN_3B1: Power pin connector

Pin	Definition
1	+12V
2	GND
3	GND
4	NC



DCIN_3B1/DCIN_3B2: Graphic card 8+8 power pin

Pin	Definition	Pin	Definition
1	GND	5	+12V
2	GND	6	+12V
3	GND	7	+12V
4	GND	8	GND

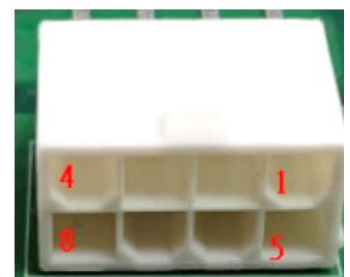

POWER_3B3: Fan power connector

Pin	Definition
1	GND
2	+12V
3	NC
4	PWM

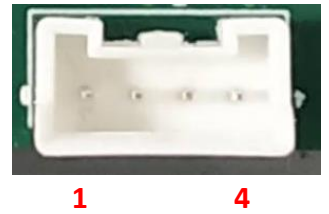

SW_3B1: Smart Fan on/off switch (for POWER_3B1)

Location	Function		Switch
DIP1	POWER_3B1	Enabled	ON (Default)
		Disabled	OFF

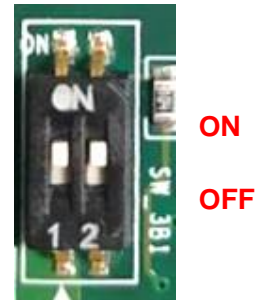

SW_3B2: Smart Fan on/off switch (for POWER_3B2 & POWER_3B3)

Location	Function		Switch
DIP1	POWER_3B2	Enabled	ON (Default)
		Disabled	OFF
DIP2	POWER_3B3	Enabled	ON (Default)
		Disabled	OFF

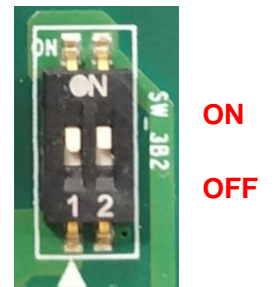

6.1.6 GEB-3601-R10 Module

6.1.5.1 Location of Switches and Connectors

Top View

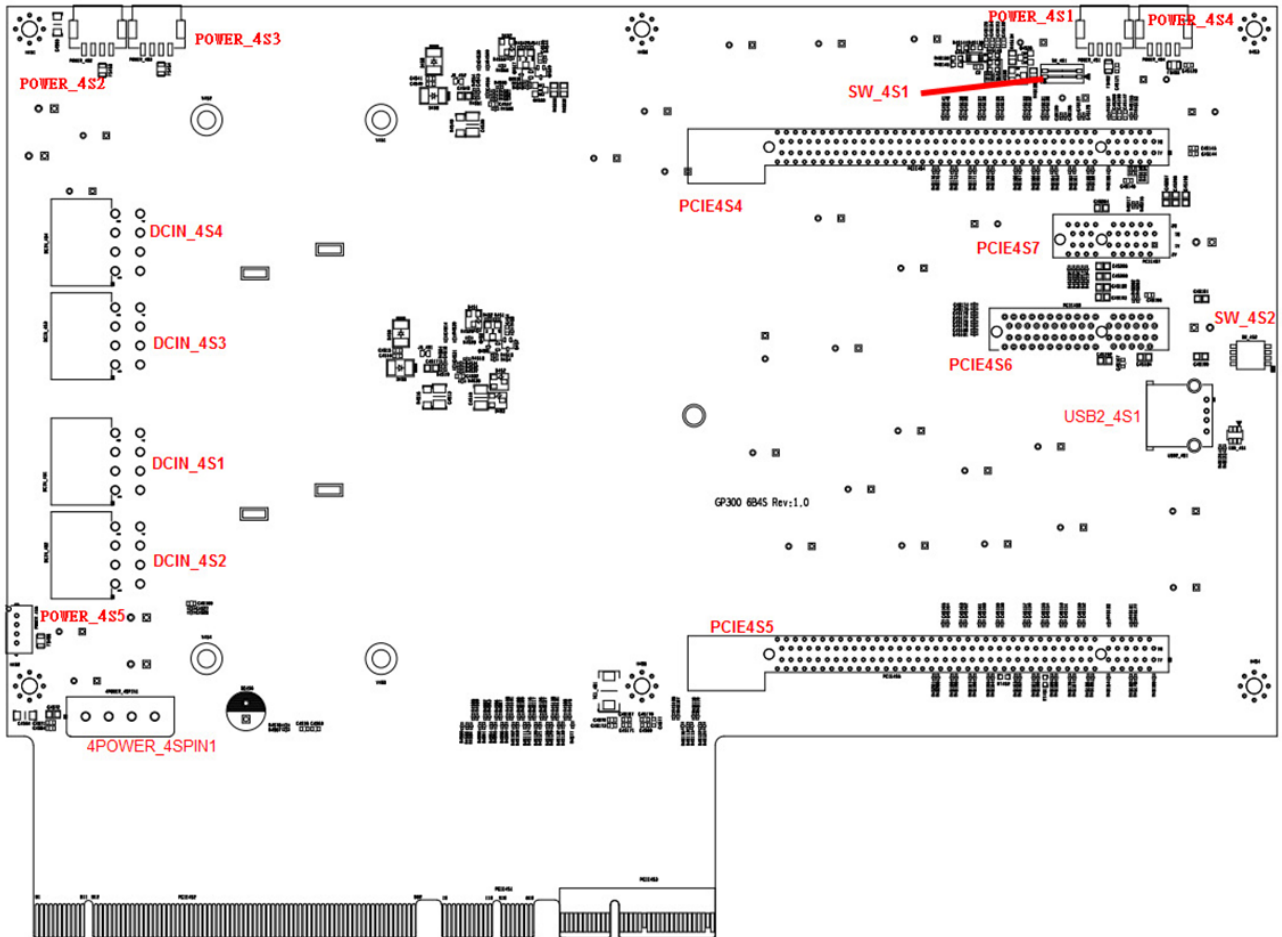

Bottom View

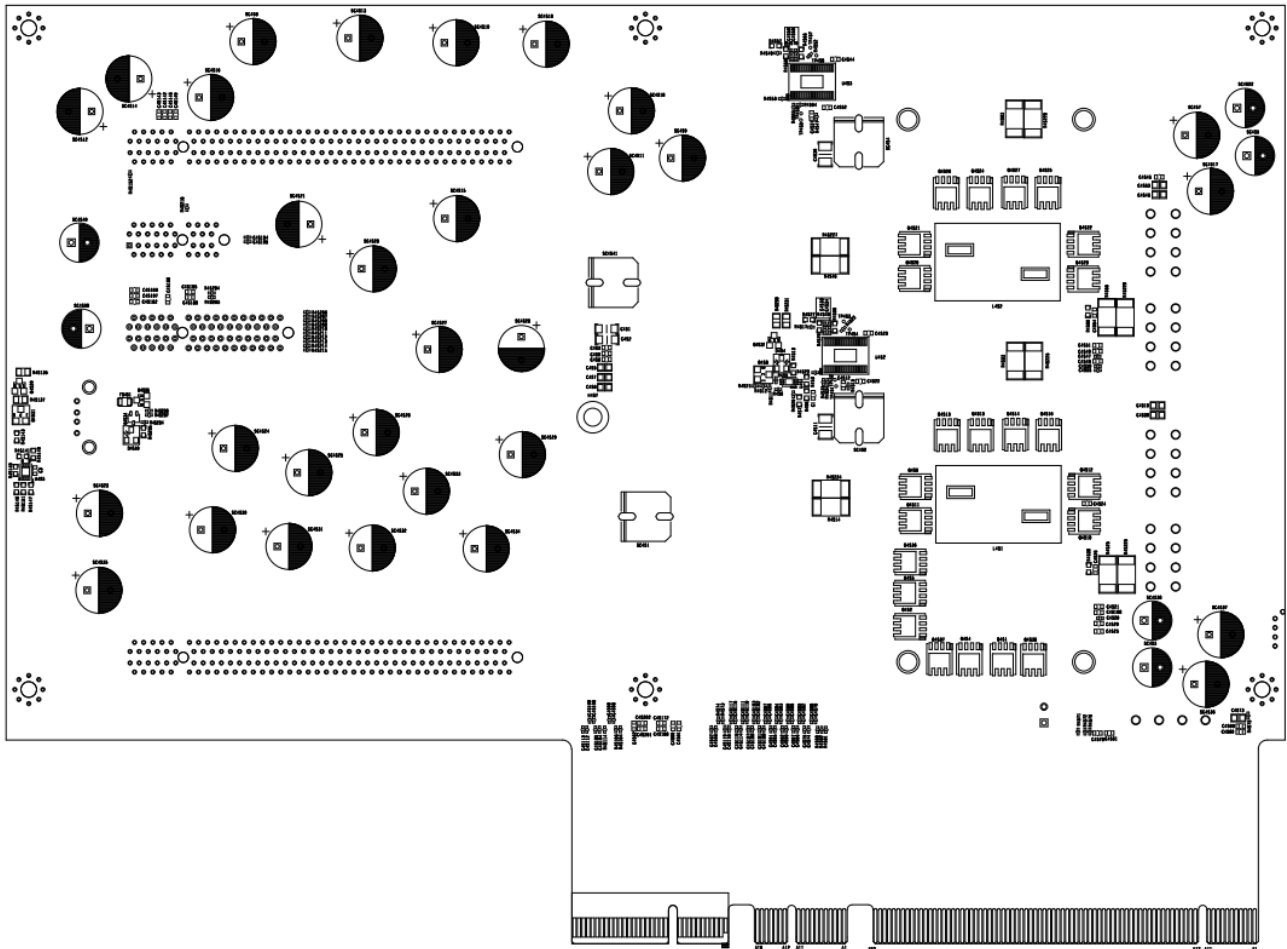

6.1.5.2 Switches and Connectors Definition

List of Switches and Connectors

Location	Definition
4POWER_4SPIN1	Graphic power connector
DCIN_4S1, DCIN_4S2	Graphic Card 8+8 power connector
DCIN_4S3, DCIN_4S4	Graphic Card 8+8 power connector
PCIE4S4	PClex8 with x16 slot
PCIE4S5	PClex8 with x16 slot
PCIE4S6	Standard PClex4 slot
PCIE4S7	Standard PClex1 slot
POWER_4S1	Fan power connector
POWER_4S2	Fan power connector
POWER_4S3	Fan power connector
POWER_4S4	Fan power connector
POWER_4S5	Fan power connector
SW_4S1	Smart Fan on/off switch (for POWER_4S1 & POWER_4S4)
SW_4S2	Smart Fan on/off switch (for POWER_4S2 & POWER_4S3 & POWER_4S5)
USB2_4S1	Standard USB 2.0 connector

6.1.5.3 Definition of Switches and Connectors

4POWER_4SPIN1: Power pin connector

Pin	Definition
1	+12V
2	GND
3	GND
4	NC



DCIN_4S1/ DCIN_4S2/ DCIN_4S3/ DCIN_4S4: for Graphic card 8+8 power pin

Pin	Definition	Pin	Definition
1	GND	5	+12V
2	GND	6	+12V
3	GND	7	+12V
4	GND	8	GND

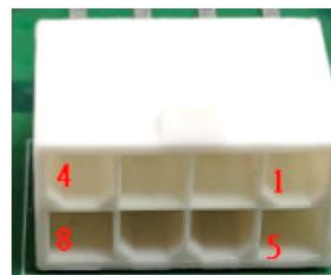

SW_4S1: Smart Fan on/off switch (for POWER_4S1 & POWER_4S4)

Location	Function		Switch
DIP1	POWER_4S1	Enabled	ON (Default)
		Disabled	OFF
DIP2	POWER_4S4	Enabled	ON (Default)
		Disabled	OFF



SW_4S2: Smart Fan on/off switch (for POWER_4S2 & POWER_4S3 & POWER_4S5)

Location	Function		Switch
DIP1	POWER_4S2	Enabled	ON (Default)
		Disabled	OFF
DIP2	POWER_4S3	Enabled	ON (Default)
		Disabled	OFF
DIP3	POWER_4S5	Enabled	ON (Default)
		Disabled	OFF



6.2 Installing High Speed CMI Module

6.2.1 CMI-LAN01-R12/UB1412 Module

1. Loosen the 2 hex nuts on the back side of the cover plate, and then remove the cover plate.

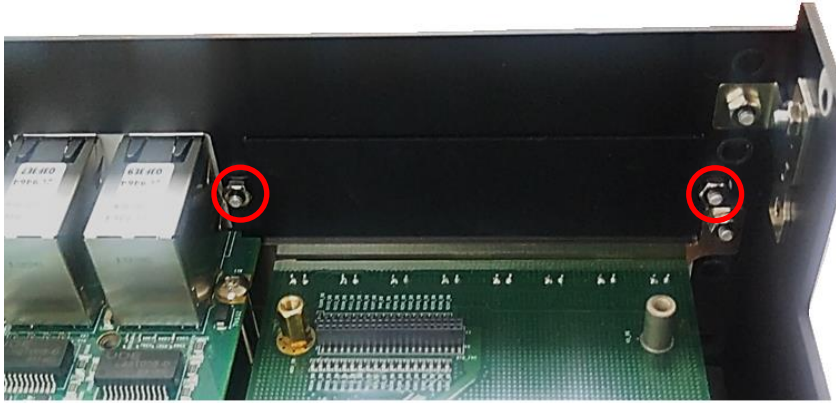

2. Attach the CMI-LAN bracket, and fasten the 2 hex nuts to fix it as indicated.

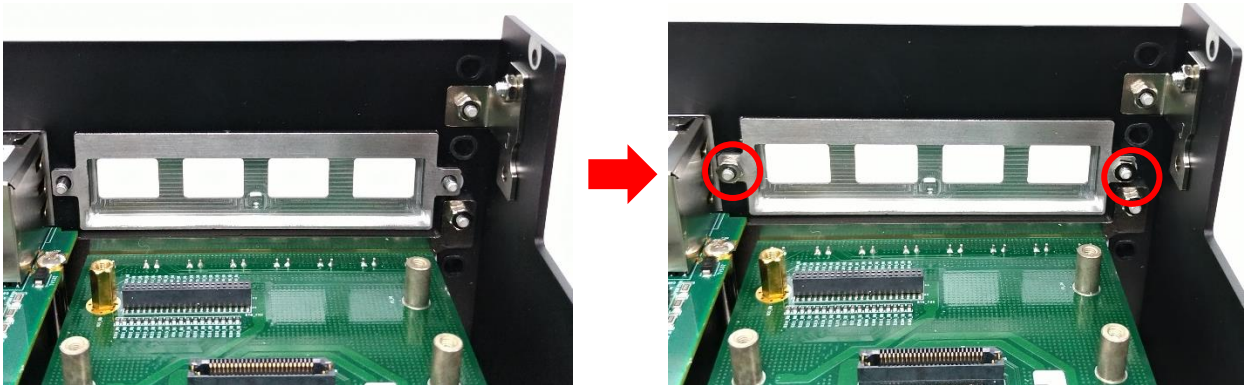

3. Locate the connector BTB_FH1_DB on DP-300 DTB.

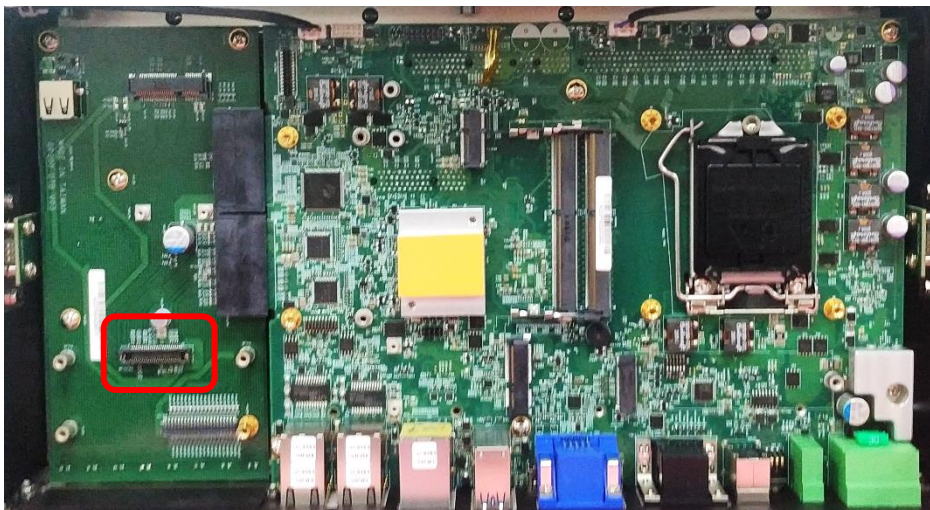

4. Aim the module's LAN ports at the holes on the bracket with an inclined angle, push it slightly and insert it vertically to the connector BTB_FH1_DB.

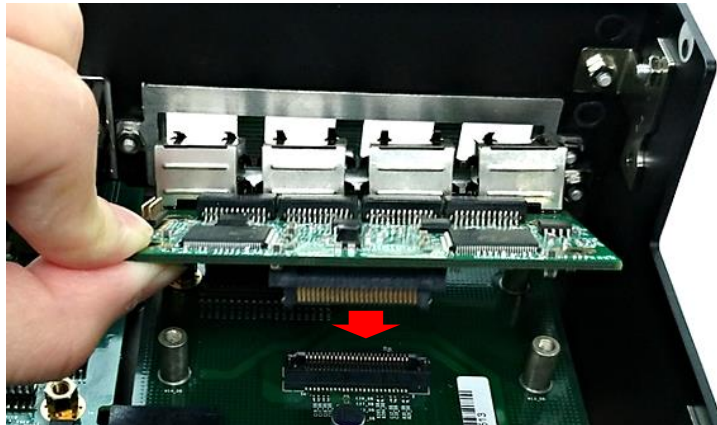

5. Fix it with the four screws.

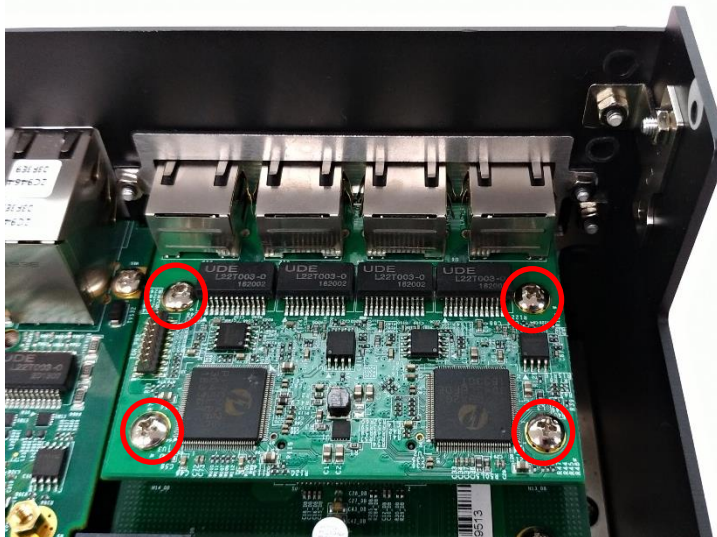

6.2.2 CMI-M12LAN01-R12/UB1410 Module

1. Loosen the 2 hex nuts on the back side of the cover plate, and then remove the cover plate.

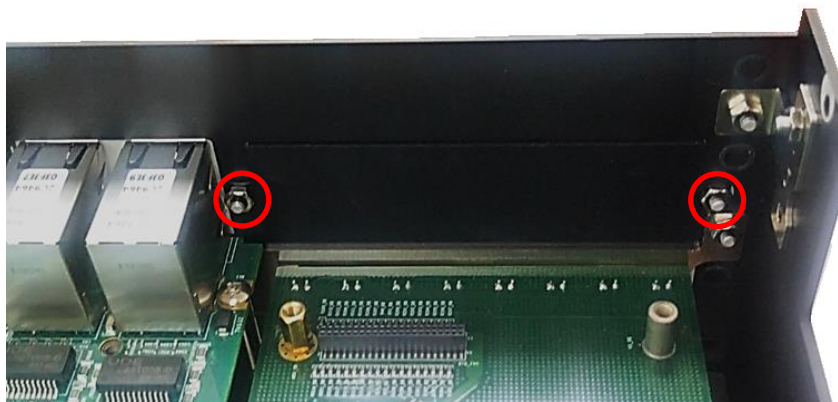

2. Attach the CMI-M12LAN bracket, and fasten the 2 hex nuts to fix it as indicated.

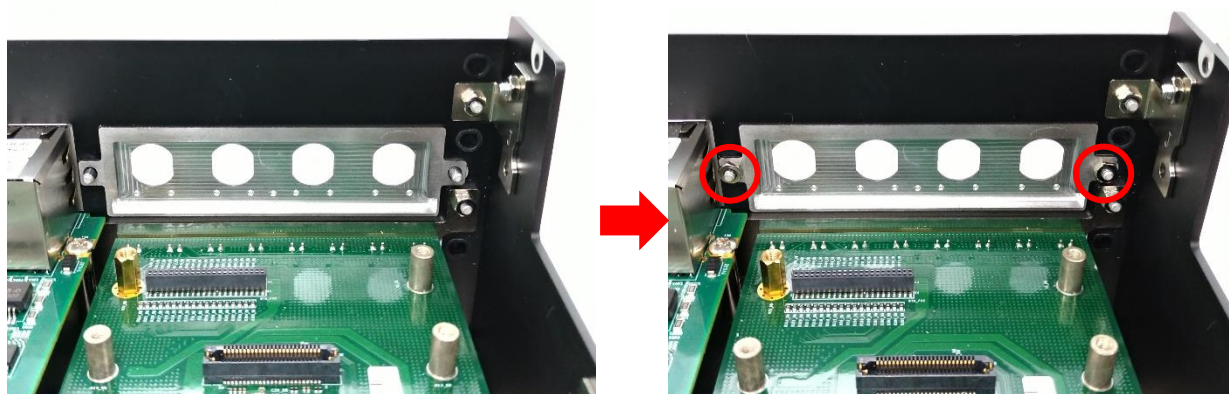

3. Locate the connector BTB_FH1_DB on DP-300 DTB.

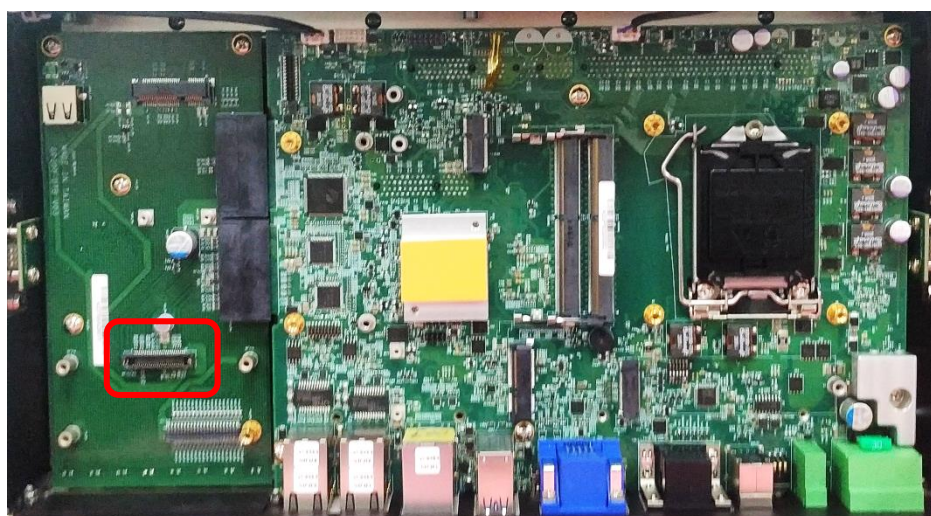

4. Remove the four hex rings from the CMI-M12LAN module.

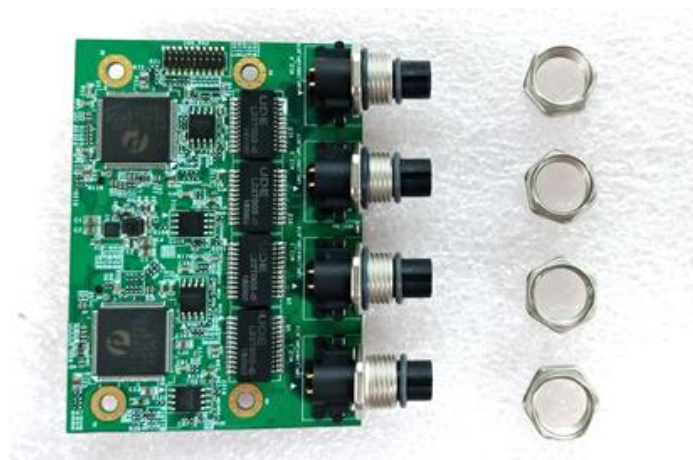

5. Penetrate the CMI-M12LAN ports through the holes on the bracket.

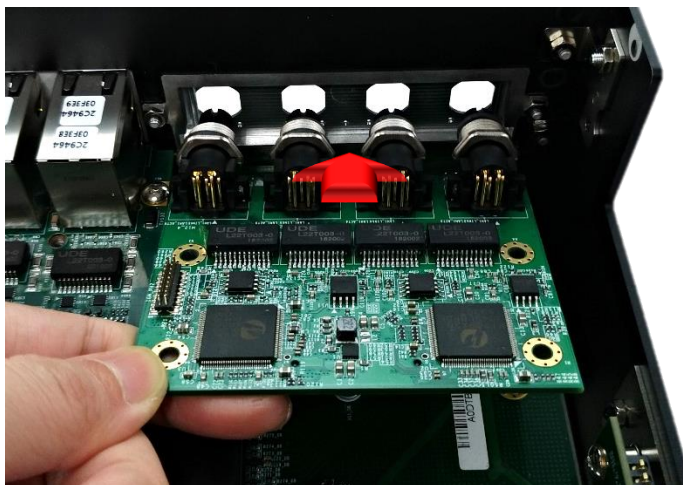

6. Push the CMI-M12LAN module slightly and insert it vertically into the connector BTB_FH1_DB.



7. Fix it with the four screws.

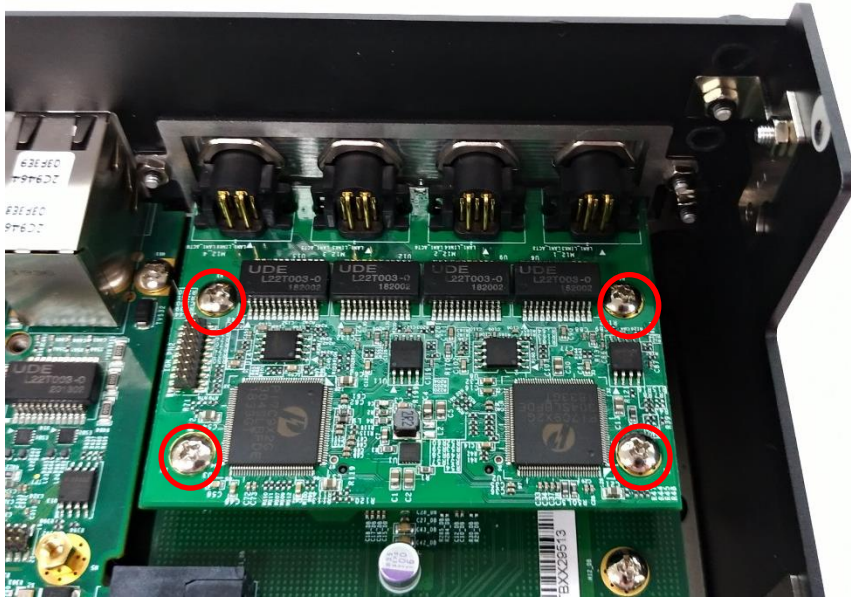

8. Fasten the four hex rings to fix the cover plate.



6.2.3 CMI-XM12LAN01-R10/UB1410 Module

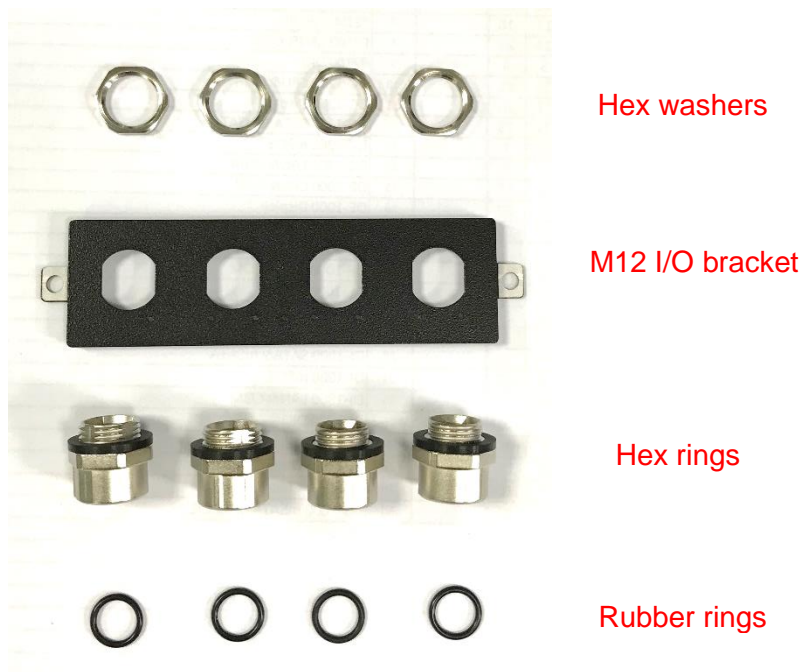

1. Assemble the hex rings, M12 I/O bracket and hex washers together as indicated below:
Penetrate hex rings through the M12 I/O bracket holes, and fix them with hex washers.



2. Loosen the 2 hex nuts on the back side of the cover plate, and then remove the cover plate.

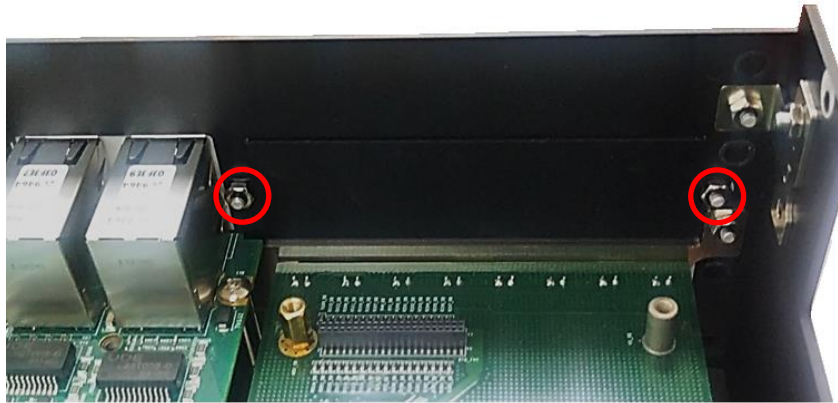

3. Attach the assembled M12 I/O bracket on to the system, and fasten the two hex nuts to fix it.

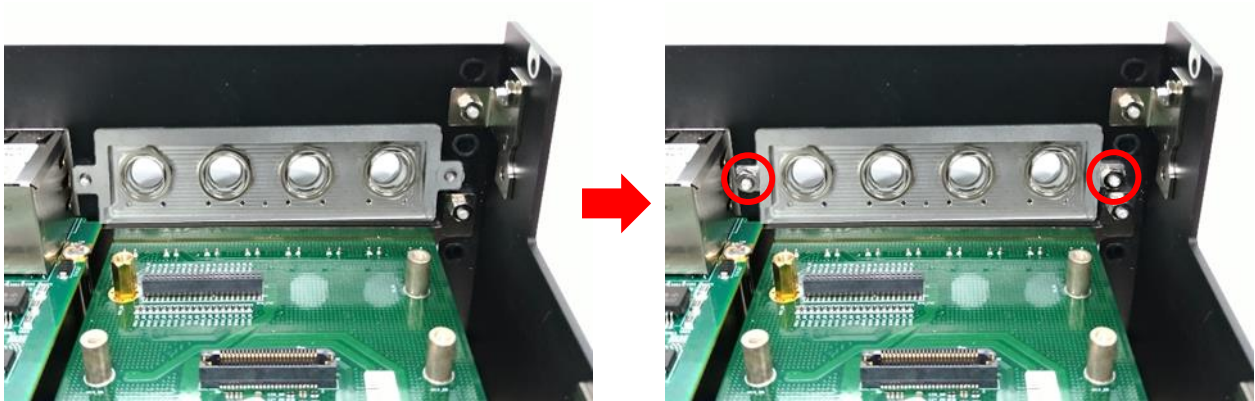

4. Locate the connector BTB_FH1_DB on DP-300 DTB.

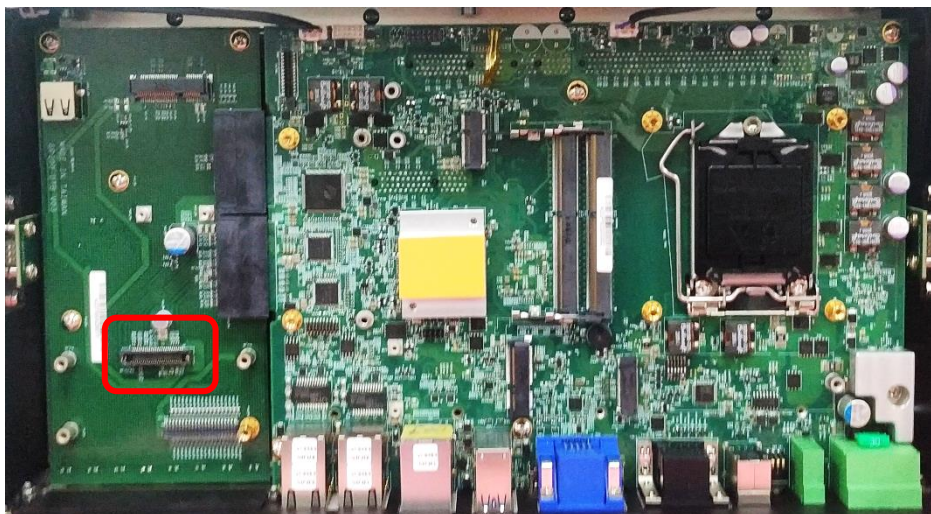

5. Penetrate the CMI-XM12LAN ports through the holes on the bracket.

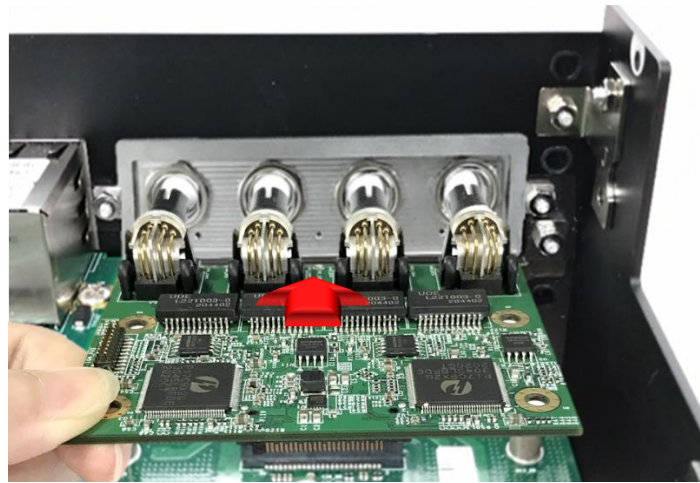

6. Push the CMI-XM12LAN module slightly and insert it vertically into the connector BTB_FH1_DB.



7. Fix it with the four screws.



- 8. Put on the rubber rings to the four M12 LAN ports.

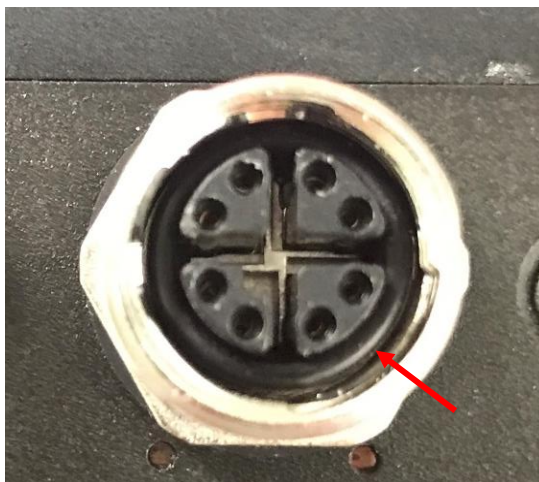

6.2.4 CMI-10GLAN02-R10/UB1428 Module

Before installing CMI-10GLAN02-R10/UB1428 module, users need to enter BIOS to complete the following setting first. When entering BIOS, get to Chipset > PCH-IO Configuration page, and change the [DTB_FH1 Mode Selection] setting from default mode [4x1] to mode [1x4].

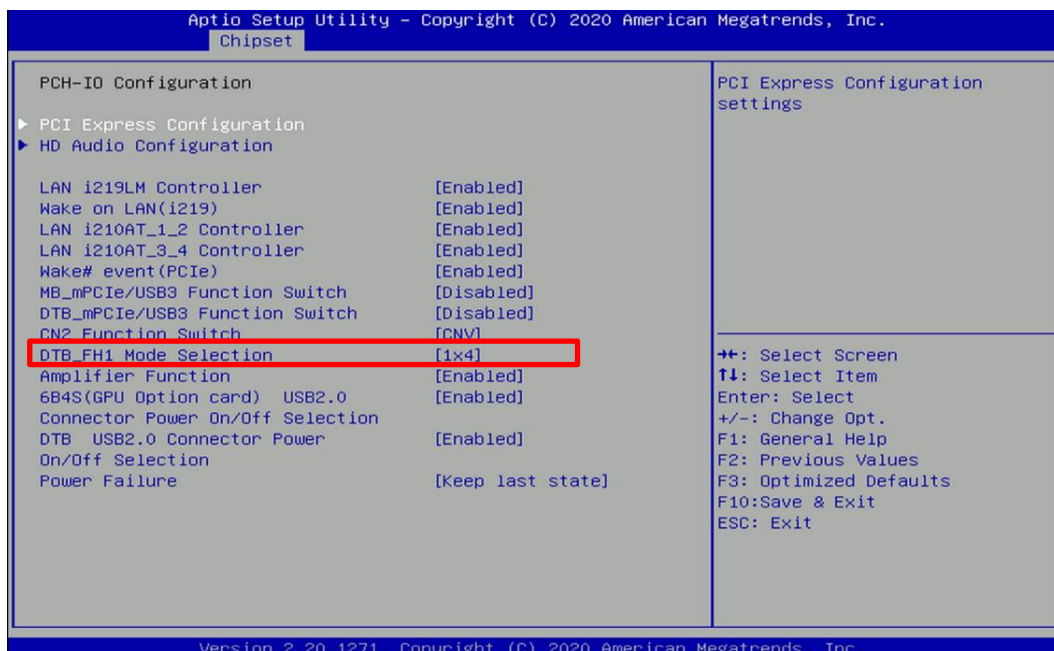

1. Loosen the 2 hex nuts on the back side of the cover plate, and then remove the cover plate.

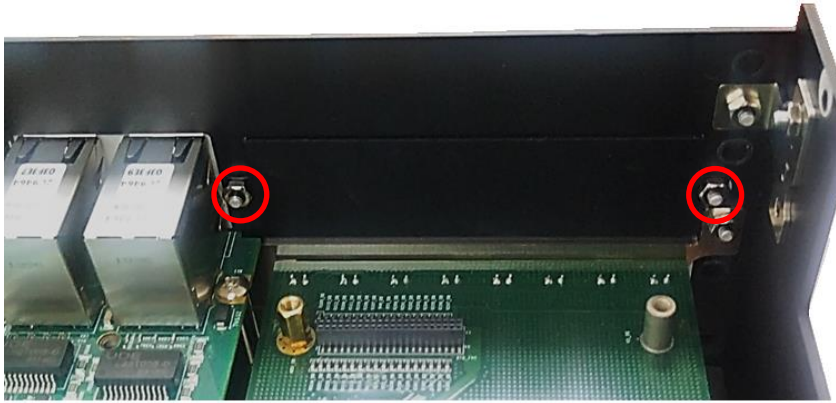

2. Attach the CMI-10GLAN bracket, and fasten the 2 hex nuts to fix it as indicated.

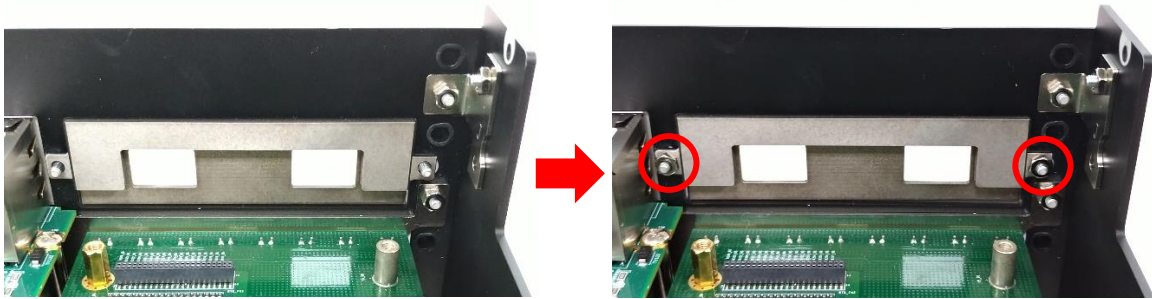

3. Locate the connector BTB_FH1_DB on DP-300 DTB.

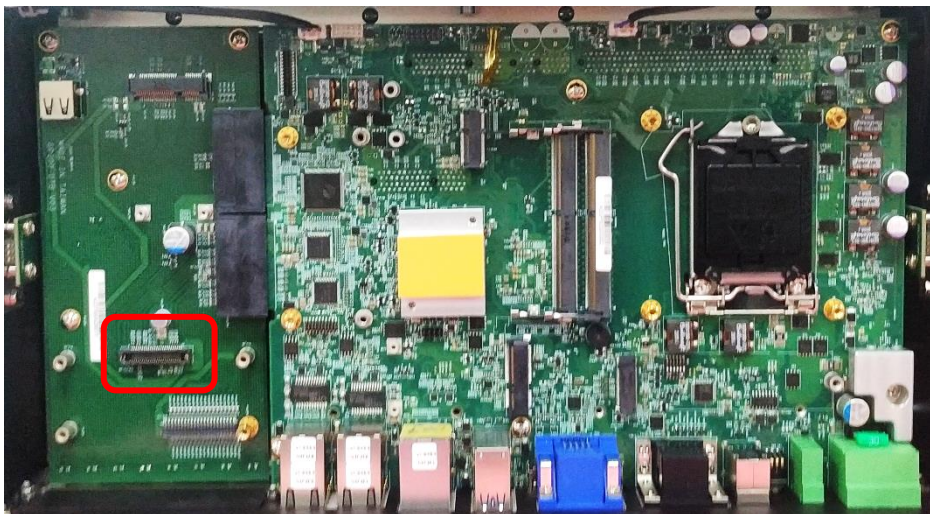

4. Locate the chip place on the CMI-10GLAN module marked by red square. Paste the thermal pad on it carefully.

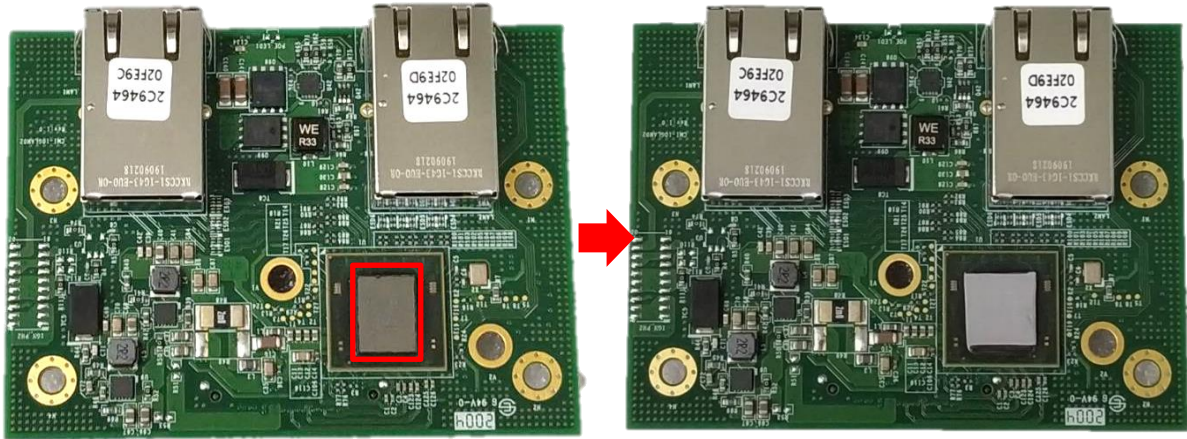

CAUTION

Before putting on the heatsink (in the next step), please make sure the transparent protective film on the Thermal Pad has been removed!

5. Put on the heatsink and turn over the module. Fasten the screw to fix the heatsink.

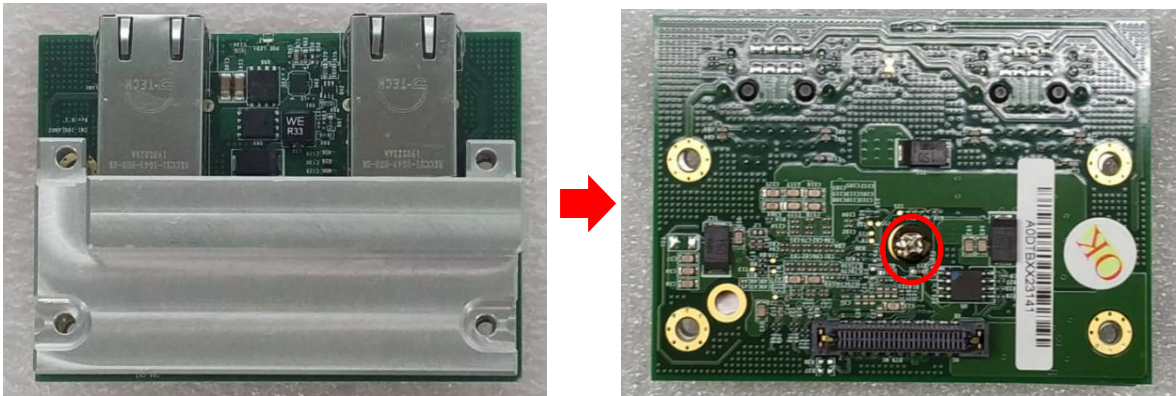

6. Aim the module's LAN ports at the holes on the bracket with an inclined angle, push it slightly and insert it vertically to the connector BTB_FH1_DB.



7. Fasten the 4 screws to fix it.

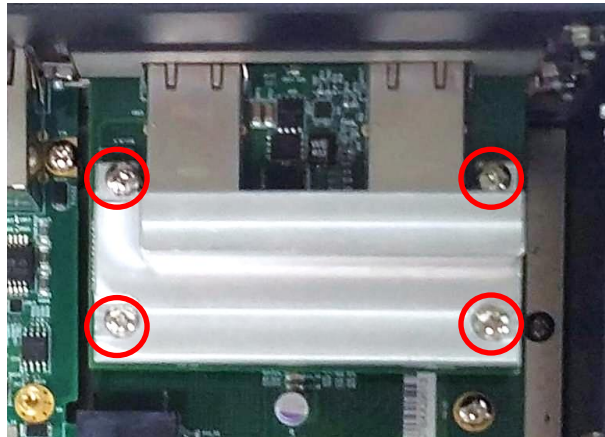

8. Paste the two thermal pads onto the heatsink carefully.

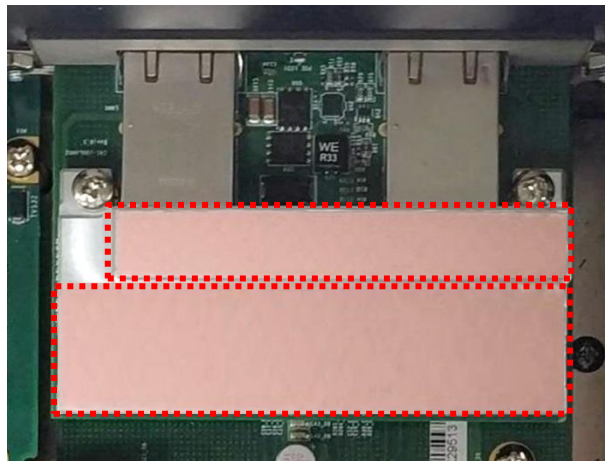

CAUTION

Before assembling the system's chassis cover, please make sure the transparent protective films on the Thermal Pads have been removed!

6.3 Installing Low Speed CMI Module

6.3.1 CMI-DIO04-R11/UB1418 Module

1. Loosen the 2 hex nuts on the back side of the cover plate, and then remove the cover plate.

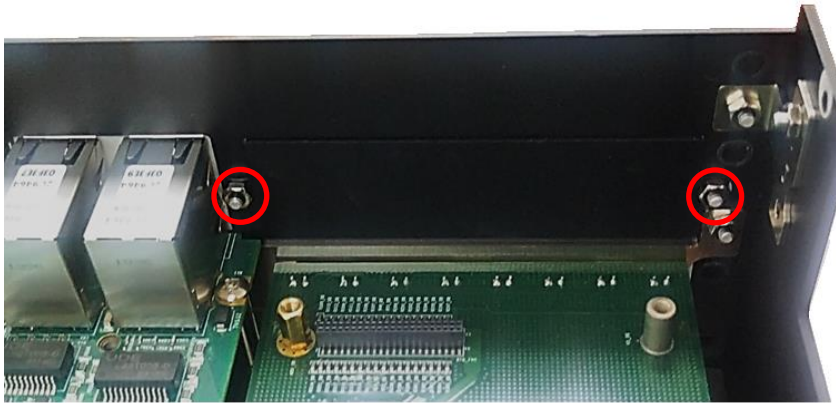

2. Attach the CMI-DIO bracket, and fasten the 2 hex nuts to fix it as indicated.



3. Locate the connector BTB_FH2 on DP-300 DTB.

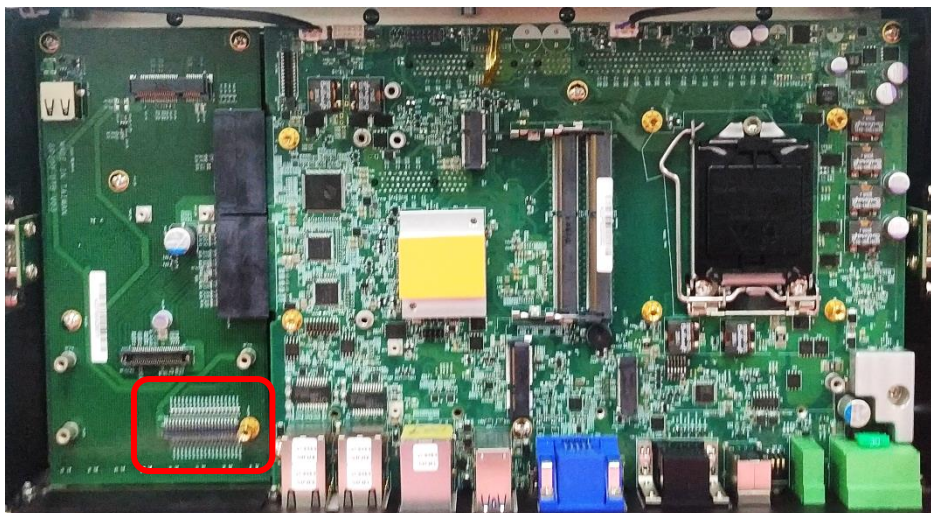

4. Replace the original copper pillar screw to the longer copper pillar screw as indicated.

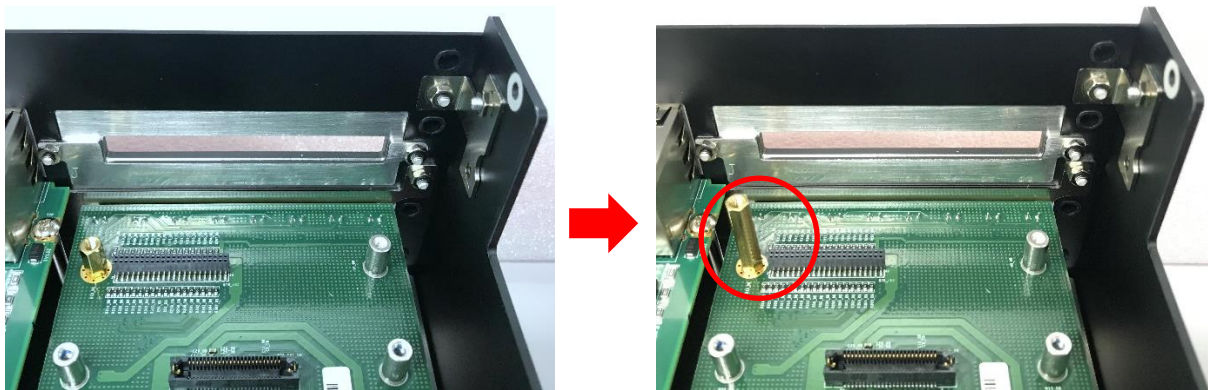

5. Push the CMI-DIO module slightly and insert it vertically to the connector BTB_FH1_DB.

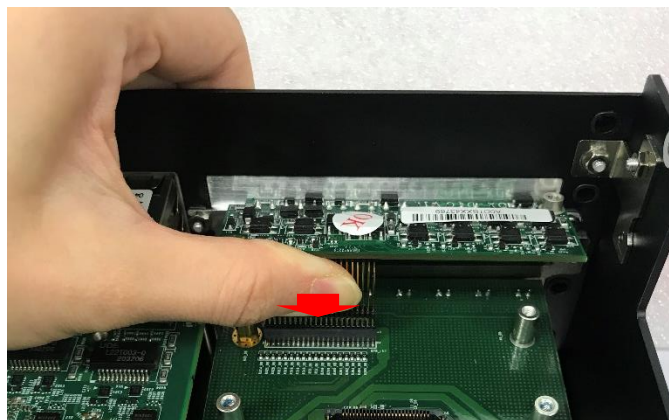

6. Fasten the screw.



7. Put the metal board on the module as indicated.



8. Fix the module and the metal board with the three screws.

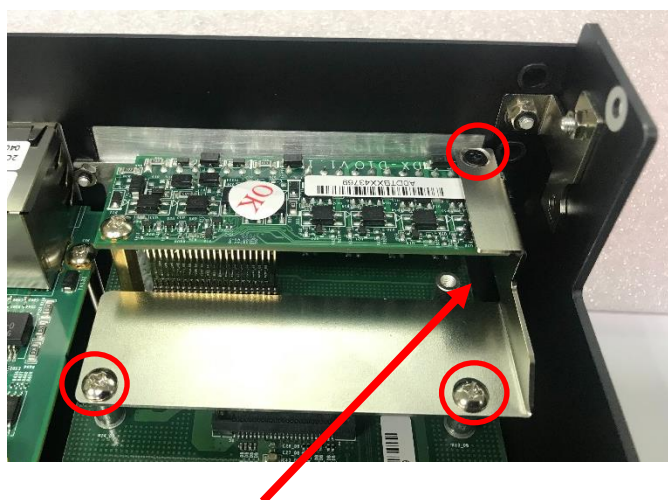

NOTE

The hovering area is normal. Please do not worry.

6.3.2 CMI-COM04-R10/UB1403 Module

1. Loosen the 2 hex nuts on the back side of the cover plate, and then remove the cover plate.

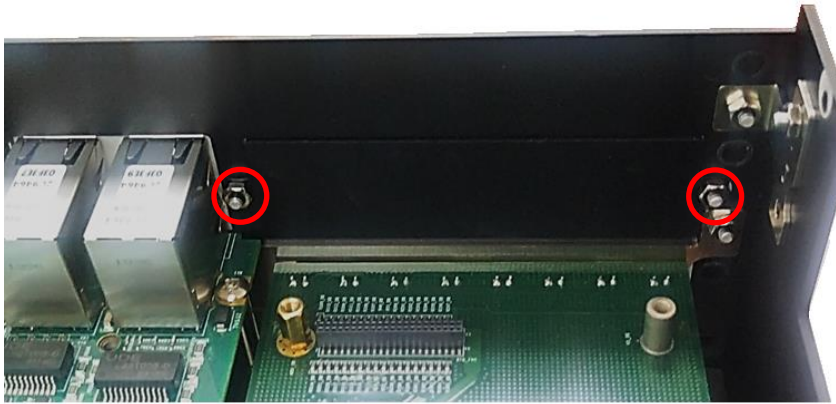

2. Attach the CMI-COM bracket, and fasten the 2 hex nuts to fix it as indicated.



3. Replace the original copper pillar screw to the longer copper pillar screw as indicated.

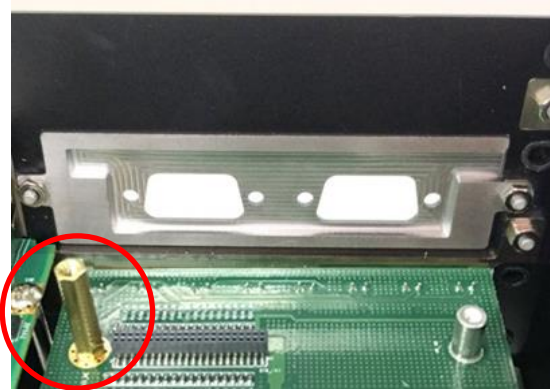

4. Locate the connector of BTB_FH2 on DP-300 DTB.

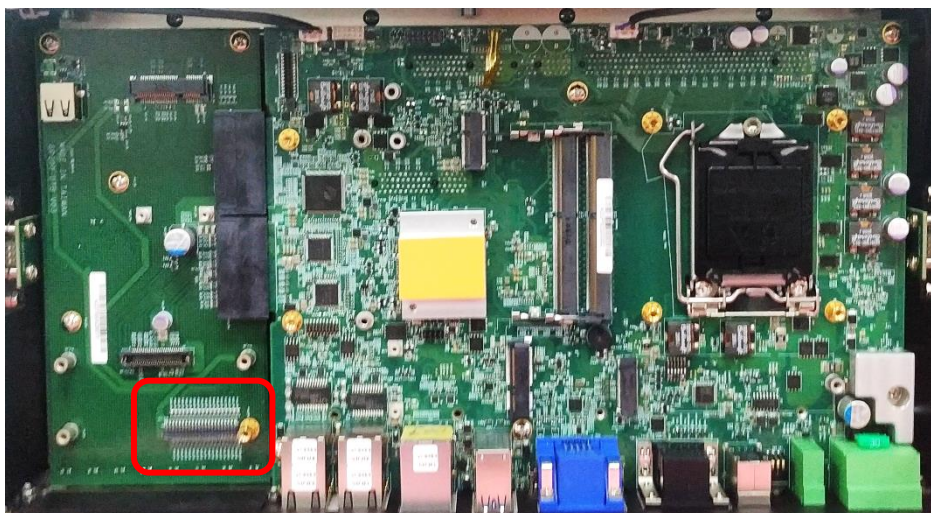

5. Penetrate the CMI-COM module through the holes on the bracket.



6. Push the CMI-COM module slightly and insert it vertically to the connector BTB_FH1_DB.



7. Fix it with the screw.



NOTE

The hovering area is normal. Please do not worry.

8. Fasten the 4 D-Sub jack screws to fix the module.



6.4 Installing CFM Module

The CFM-PoE module for GP-3000 series can be installed on the system motherboard or on the CMI-LAN module. The steps for installing a CFM-PoE module (CFM-PoE01) on the motherboard will be illustrated in chapter 6.4.1. The steps for installing a CFM-PoE module (CFM-PoE07-R10) on a CMI-LAN module will be illustrated in chapter 6.4.2.

6.4.1 CFM-PoE01 Module

1. Locate the PSE Board to Board Connector (IGN_PH2) on the system motherboard as indicated.

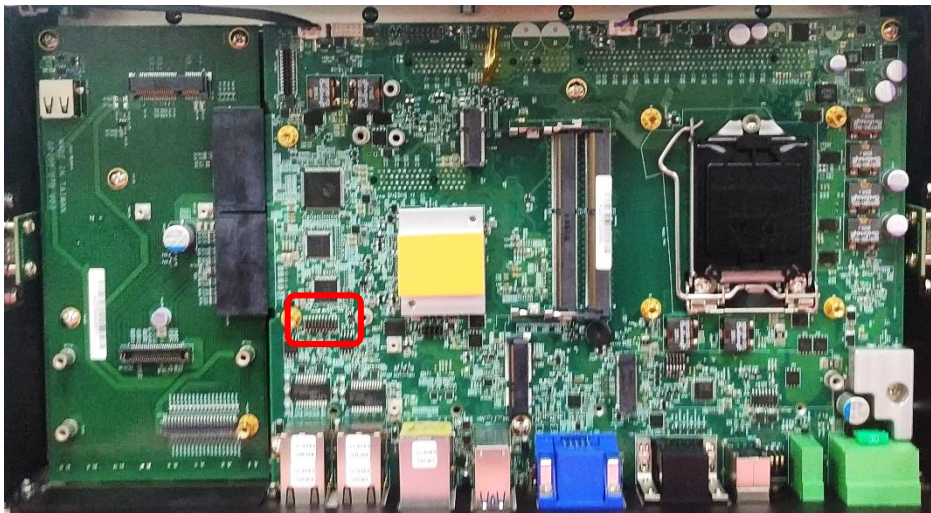

2. Insert the CFM-PoE module vertically into the female connector on the motherboard until it's connected firmly.



3. Turn over the heatsink of the CFM-PoE module and locate the two places marked by red squares. Paste the two thermal pads as indicated onto the heatsink carefully.

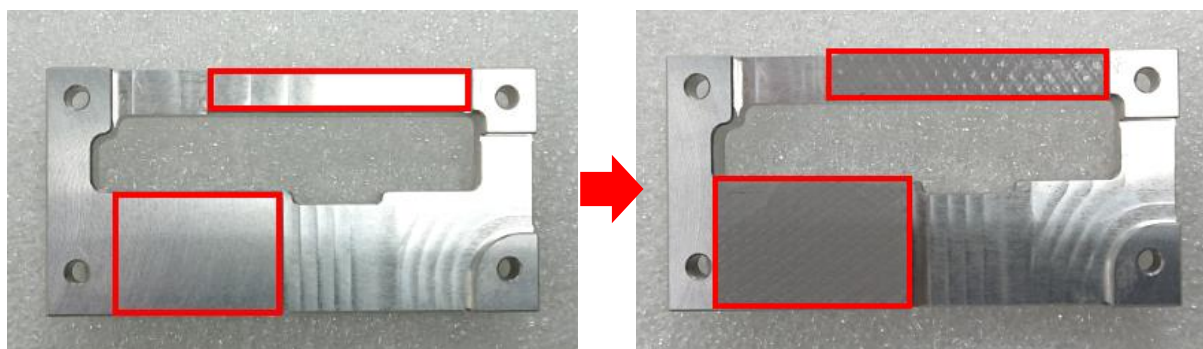

CAUTION

Before putting on the heatsink (in the next step), please make sure the protective film on the Thermal Pad has been removed!

4. Put the heatsink onto the CMI-PoE module carefully as indicated.



5. Fasten the 4 screws to fix it.

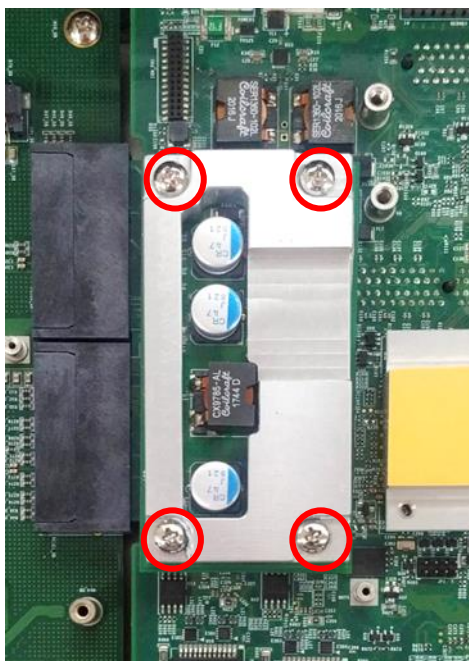

6. Paste the last thermal pad onto the heatsink carefully.

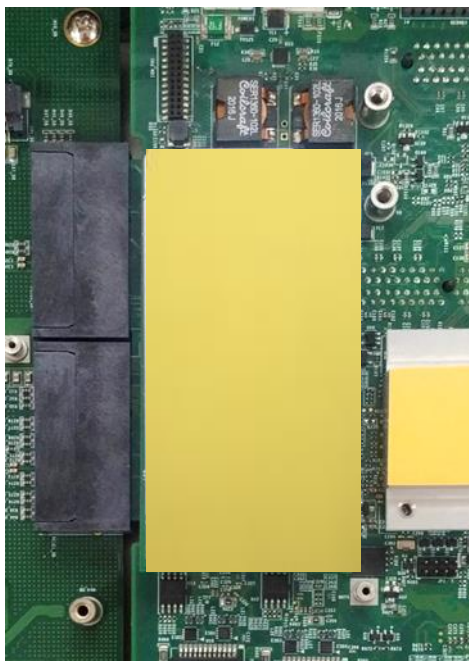

CAUTION

The yellow surface is part of the thermal pad. Do not tear it off as it would affect the thermal conductivity.

Once the steps above are finished, after system power on, PoE Function LED (at system front panel, LED_B1) will light green as indicated in Chapter 2.4.

6.4.2 CFM-PoE07-R10 Module

The CFM-PoE07-R10 module can be installed on the CMI-LAN or CMI-M12LAN module. (This chapter will take the CMI-M12LAN module for example.)

1. Please execute the installation step 1 to step 6 in Chapter 6.2.2 in advance, and fasten the 4 copper pillars to fix the CMI-M12LAN module.

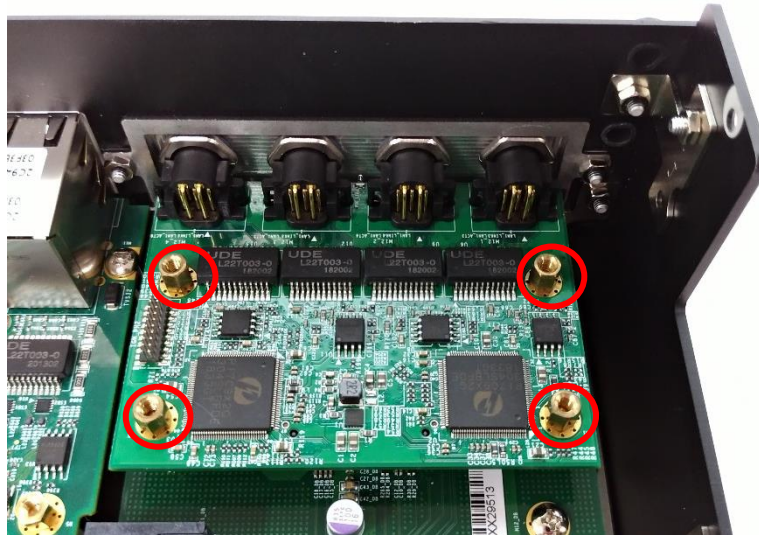

2. Insert the CFM-PoE07 module vertically into the male connector on the CMI module until it's connected firmly.



3. Turn over the heatsink of CFM-PoE07 and locate the two places marked by red squares. Paste the two thermal pads for CFM-PoE07 onto the heatsink carefully.

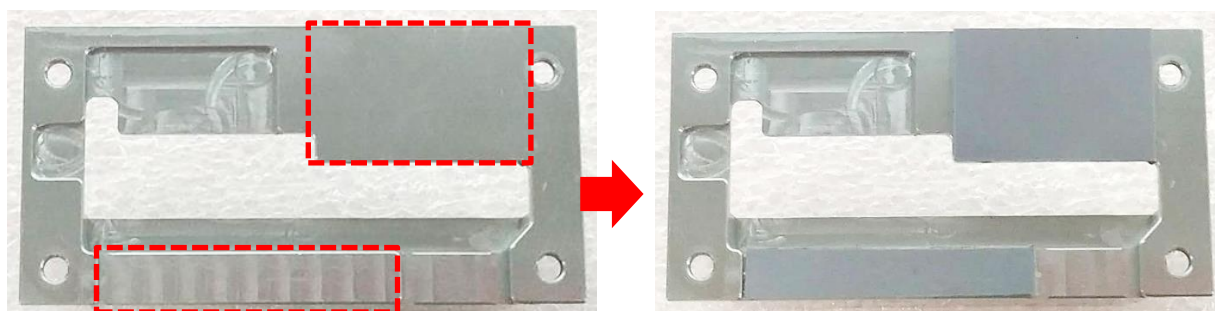

4. Paste a thermal pad on the choke.



CAUTION

Before putting on the heatsink (in the next step), please make sure the protective films on the thermal pads (step3~4) have been removed!

5. Put the heatsink onto the CMI-PoE module carefully as indicated.

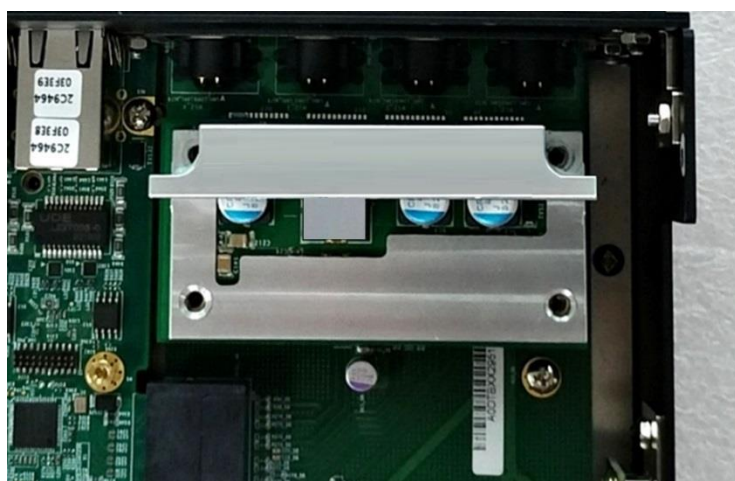

6. Fasten the 4 screws to fix it.

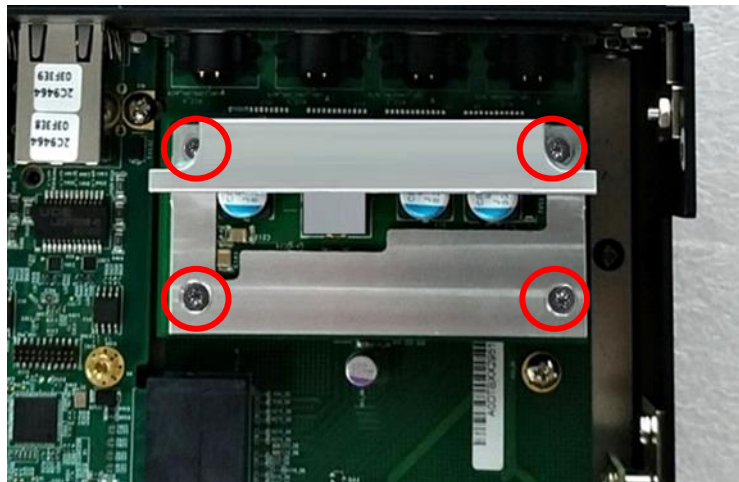

7. Paste the last two thermal pads onto the heatsink carefully, and then execute the step 8 in Chapter 6.2.2 to complete the installation.

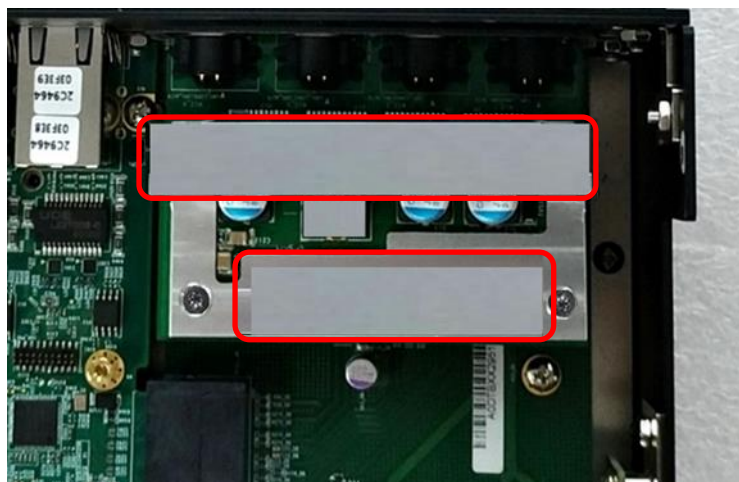

CAUTION

Before assembling the system's chassis cover, please make sure the transparent protective film on the Thermal Pad has been removed!

Once the steps are finished, after system power on, the PoE LED (on the CMI-LAN module) will light blue as shown below.



6.4.3 CFM-IGN03-R11 Module

1. Locate the power Ignition connector (IGN_PH1) on the system motherboard as indicated.

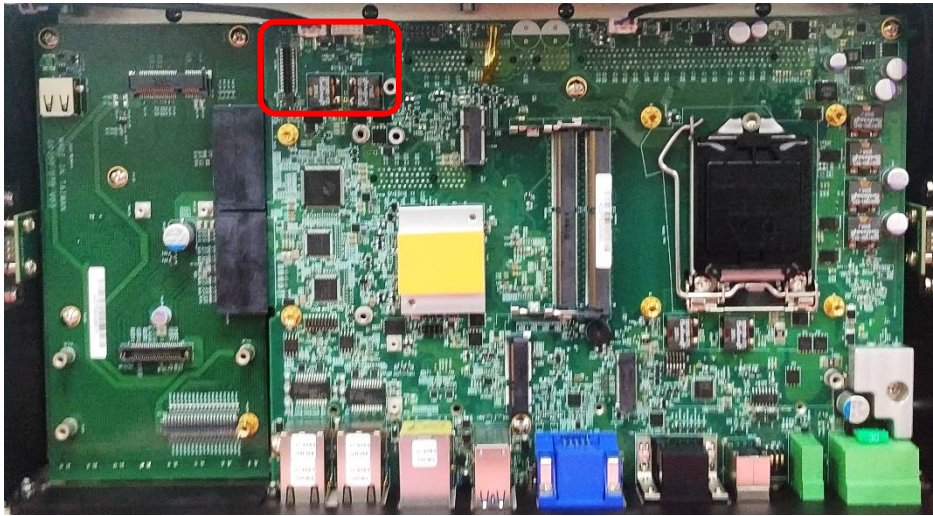

2. Insert the connector of IGN module to the female connector on system motherboard. (Make sure all the pins of IGN module's connector are firmly connected.)



3. Fasten a screw to secure the power ignition board.

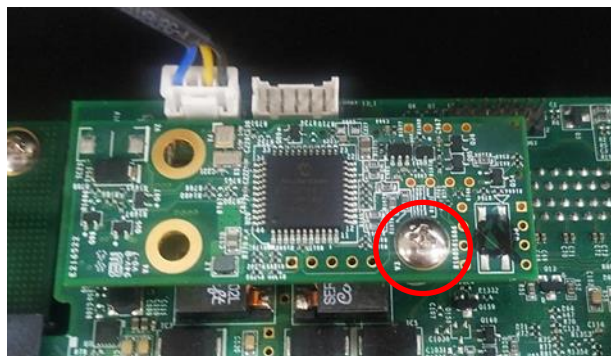

6.5 Installing MEC Module

6.5.1 MEC-USB-M102-15/UB1414 Module

1. Loosen the 2 hex nuts on the back side of the cover plate, and then remove the cover plate.

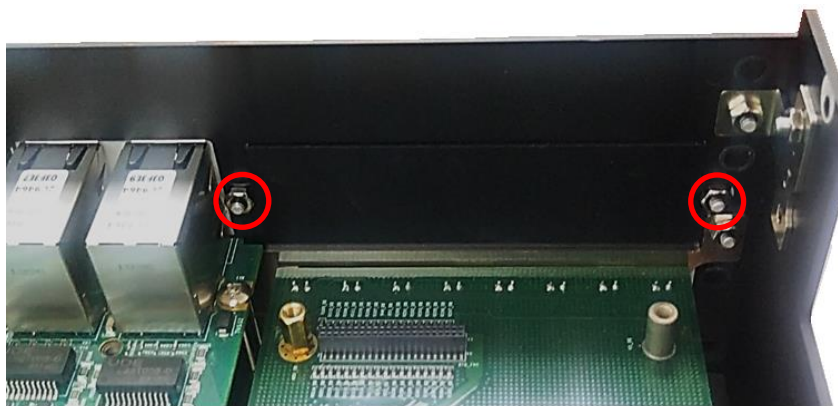

2. Attach the MEC-USB bracket, and fasten the 2 hex nuts to fix it as indicated.

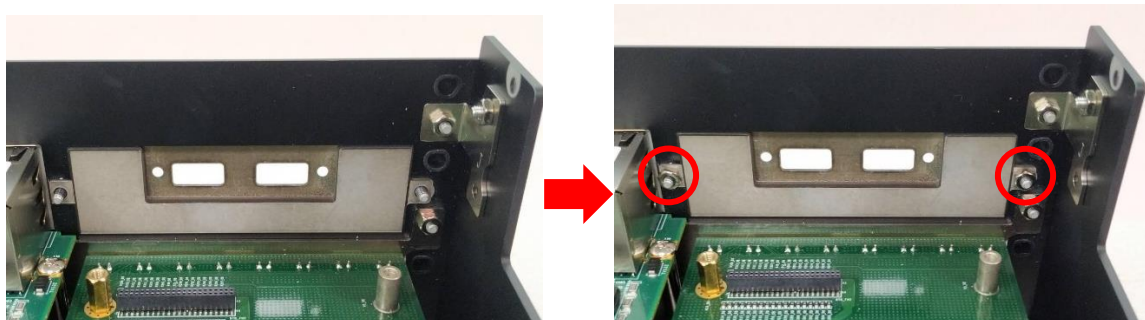

3. Locate the Mini PCIe socket CN1_DB on DP-300 DTB.

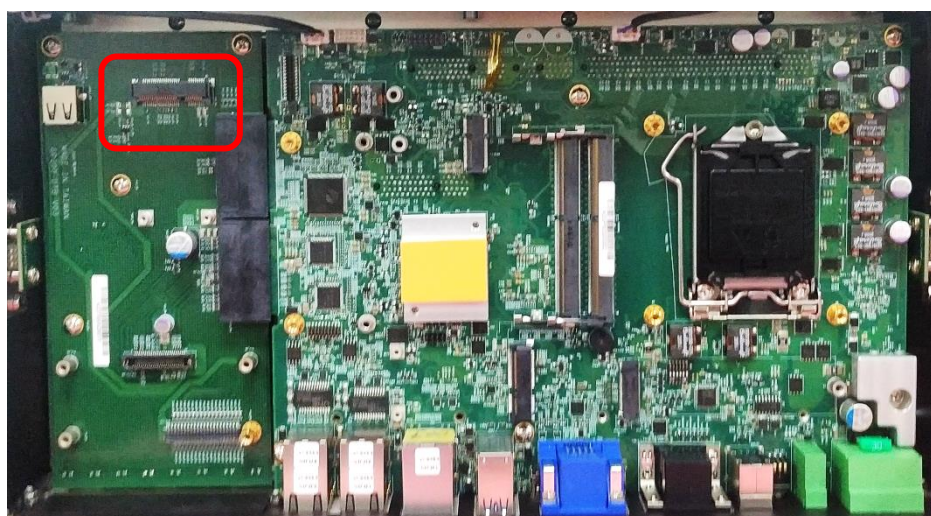

4. Tilt the Mini PCIe card at a 45-degree angle and insert it to the socket until the golden finger connector of the card seated firmly.

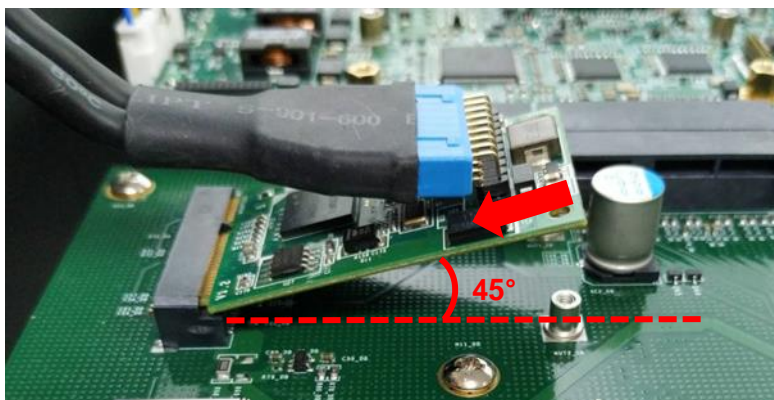

5. Press the card down and secure it with 2 screws.



6. Attach the USB board to the back side of the cover plate.



7. Fasten the two screws to fix the module.



6.6 Installing GEB-3301-R10 Module

6.6.1 Installing GEB-3301-R10 Module onto GP-3000

1. Locate the rear panel of the module. Remove the protective shell on the riser card.



2. Loosen the screws on the panels of the module.

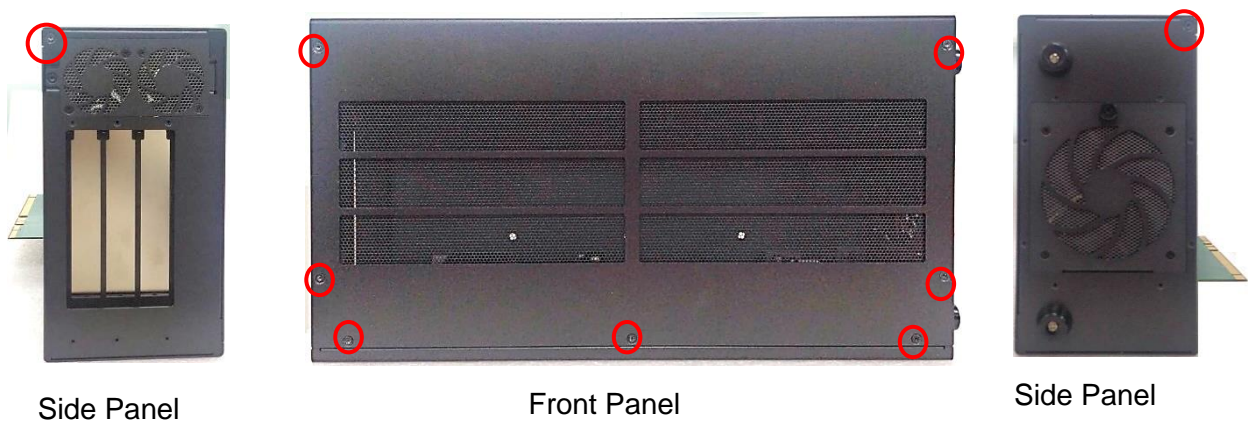

3. Turn to the rear panel side of the module. Lift up the top panel of the module.

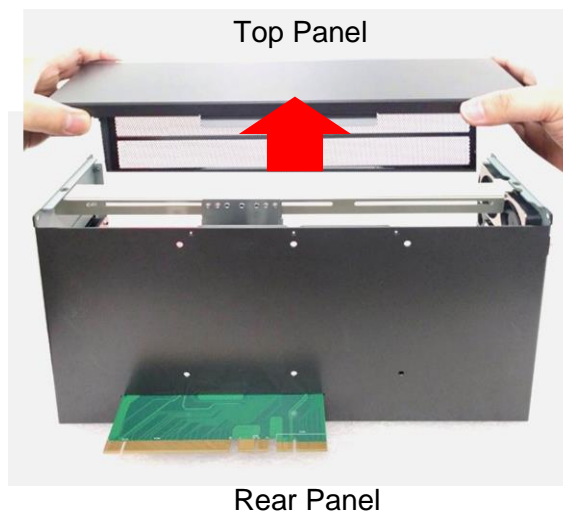

4. Loosen the screws on the bottom side of GP-3000 and remove the bracket.

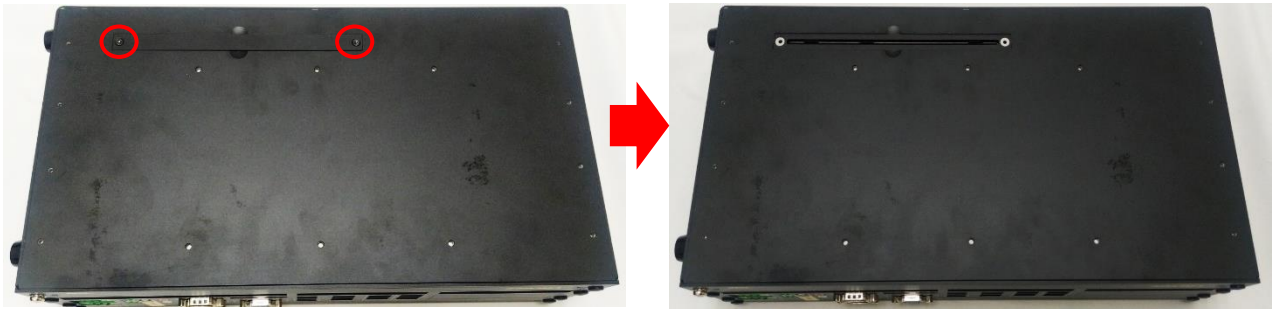

5. Hold the module, align the riser card's golden pins with the socket of GP-3000. Insert the riser card to the socket of GP-3000.

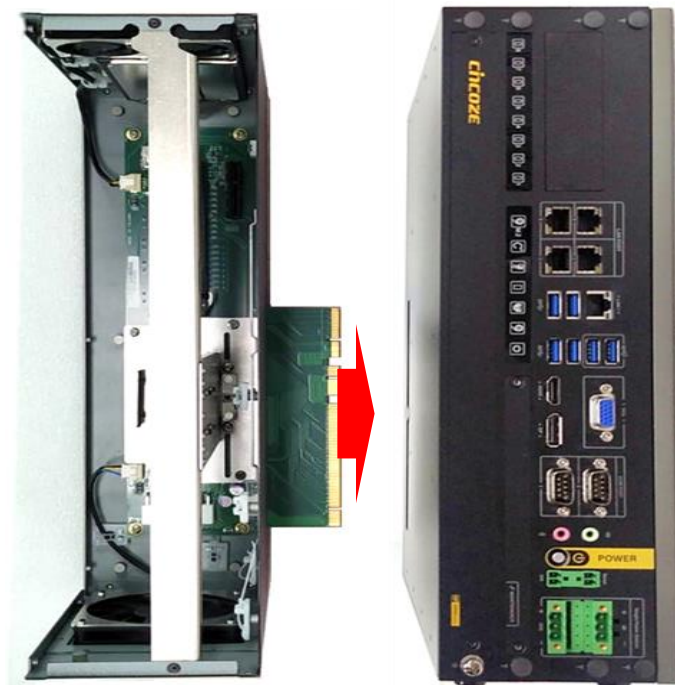

6. Ensure the module is firmly connected to GP-3000, and fasten the 6 screws to fix the module and GP-3000.

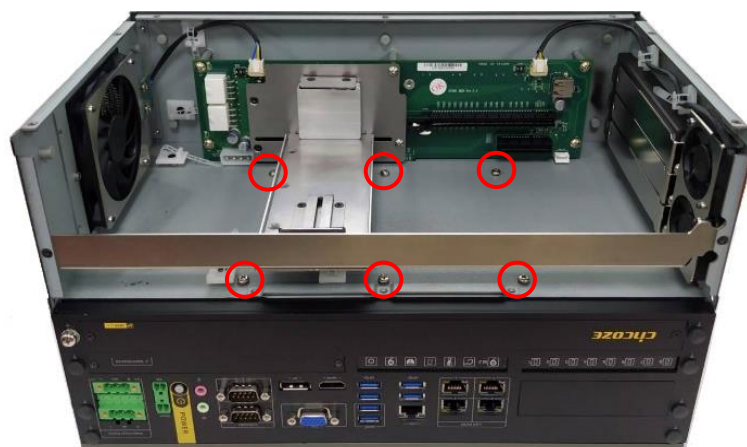

7. Put on the top panel and slide it back to the module.



8. Fasten the screws on the panels.



Side Panel



Front Panel



Side Panel

6.6.2 Installing GPU Card



NOTE

GEB-3301 maximum power budget for its PCIe16 slot is 350W.

1. Please execute the installation step 1 to step 6 in chapter 6.6.1 first, and then loosen the screw on the module's side panel.



2. Press the wire and tape to close to the fan side, and then push out the fan seat.

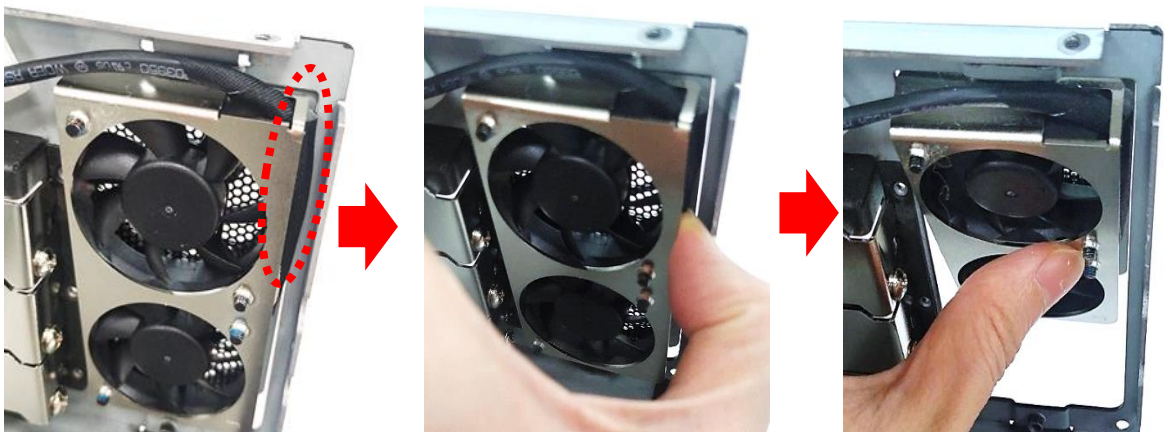

CAUTION

This step is important! Failure to follow this step may scratch and damage the wire.

3. Loosen the screw(s) to remove the I/O bracket(s).

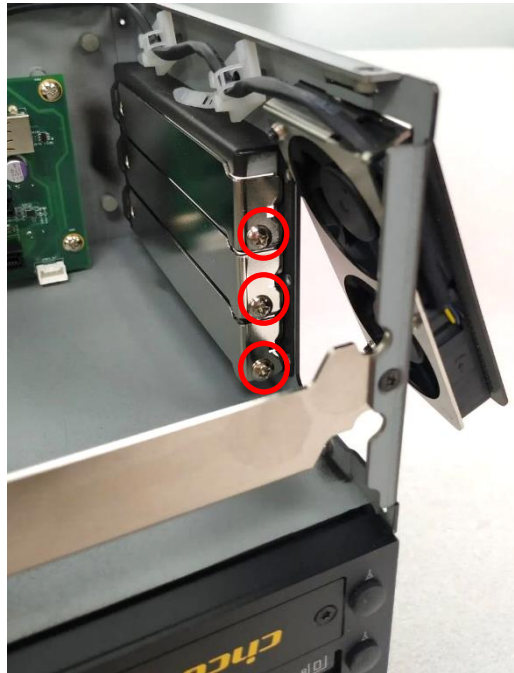

4. Loosen but not remove the four screws.



Front View

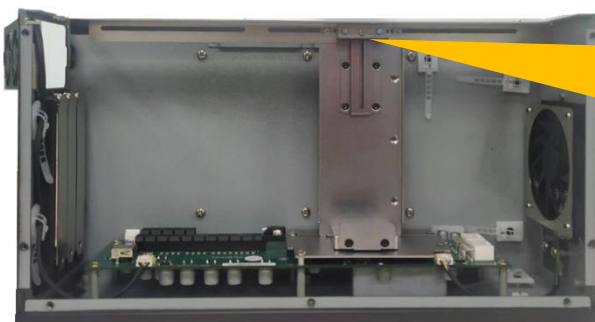
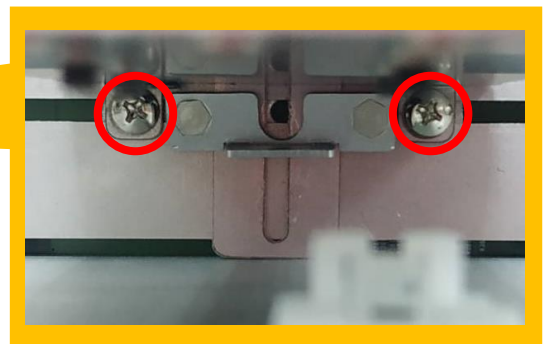

Top View



5. Move the card retainer to an appropriate place according to the GPU card's dimension.

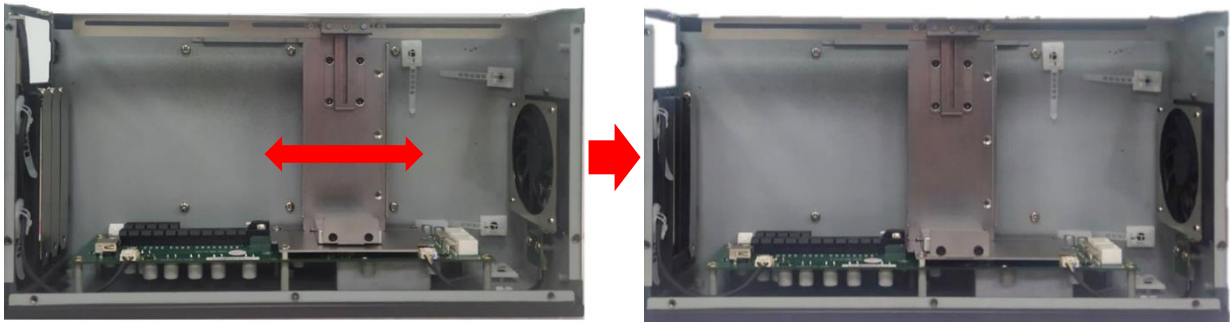

6. Loosen the two screws and move the plate to an appropriate place according to the GPU card's dimension. The length of the pre-installed screws is 35 mm. User can also replace these screws with screws of two other lengths (45 mm / 25 mm) according to the GPU card's dimension.

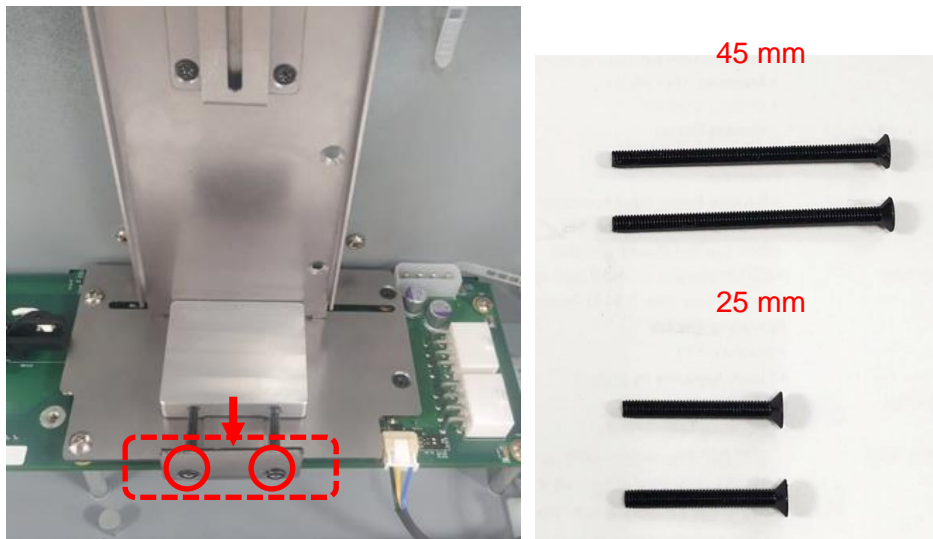

7. Insert the ends of the two wires into the connectors on the PCB as indicated.

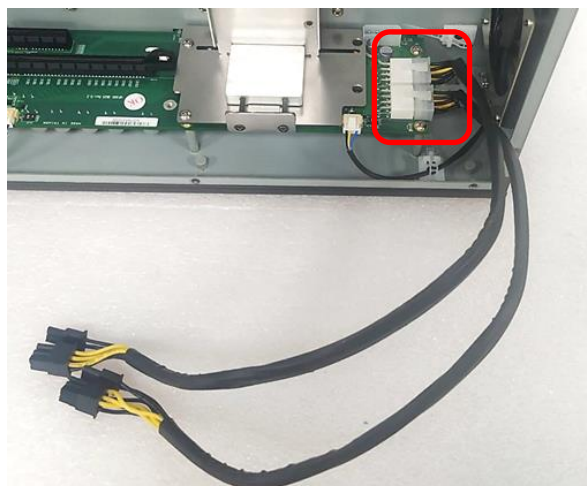

8. Insert the other ends of the two wires into the connector on the GPU card. The plug of the wire is a flexible design and can be connected to the 6-pin or 8-pin connector. (The picture shown below is just an example, the actual connection should be made according to user's GPU card.)

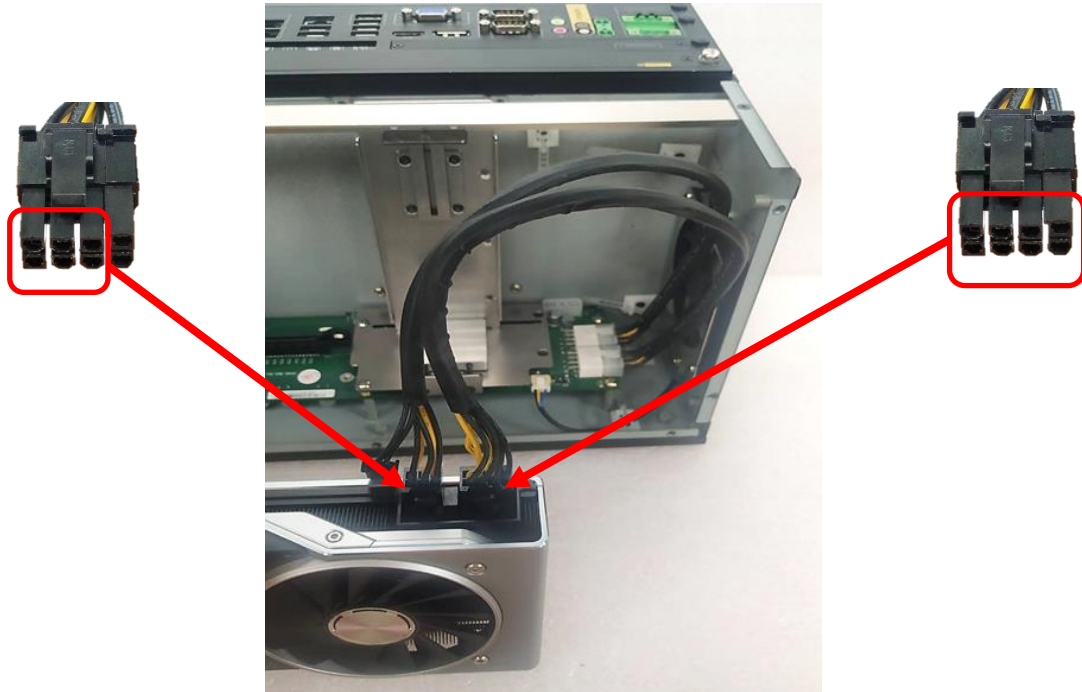

9. If there is exposed PCB on the GPU card which may touch the card retainer, please paste the black sponge bars on the lateral sides of card retainer before inserting GPU card into the module. If not, please skip this step and directly go to the step 10.

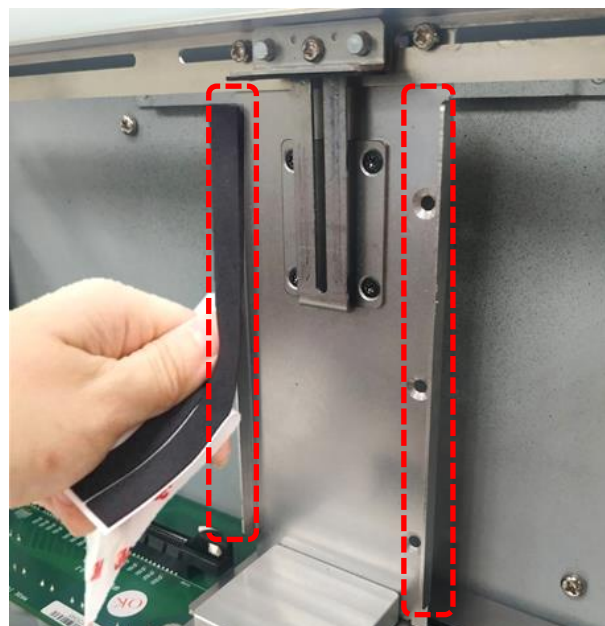

10. Insert GPU card into the PCIe socket.



11. Fasten the screws back.



12. Fasten the four screws to fix the card retainer.



Front View

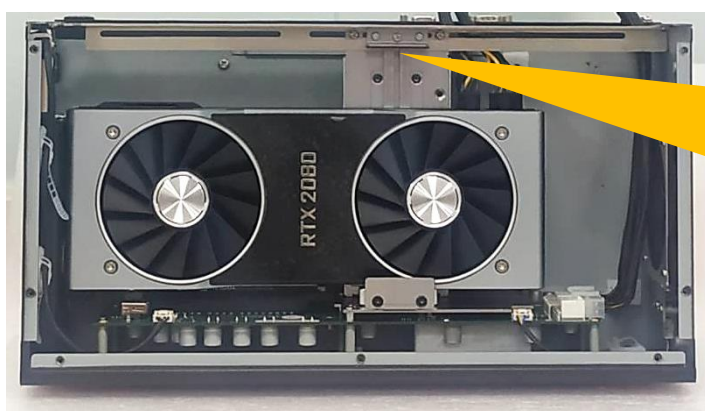
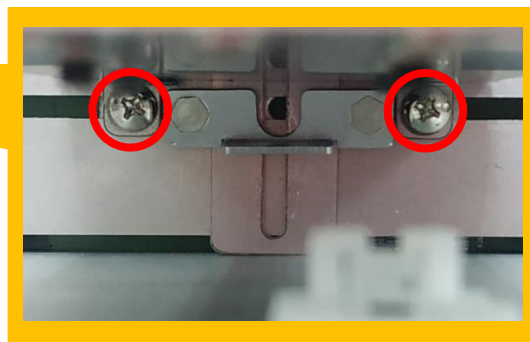

Top View



13. Push the plate till it contacts the GPU card, and then fasten the two screws to fix the GPU card.



14. Fasten the screw (M3X6L) to fix the card retainer.



NOTE

It is normal that the GPU card might be too thick to fasten the screw to the hole.

15. Loosen but not remove the screw.

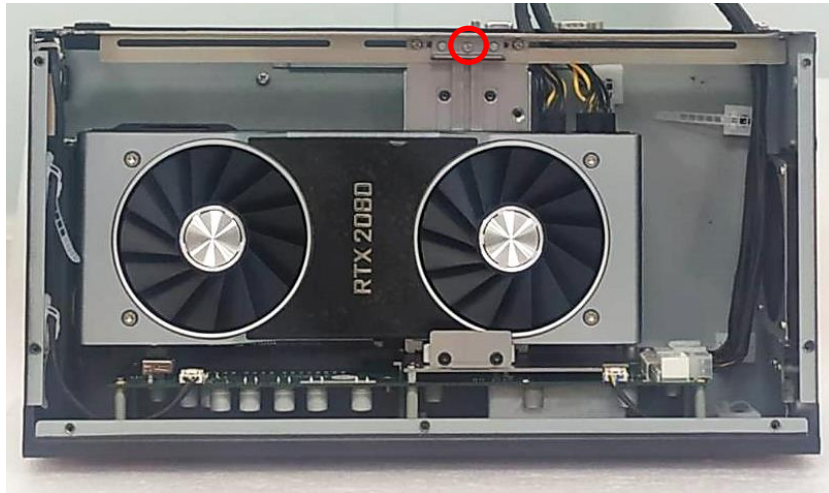

16. Make sure that the metal plate slides down until it touches the GPU card, and then fasten the screw to fix the GPU card.

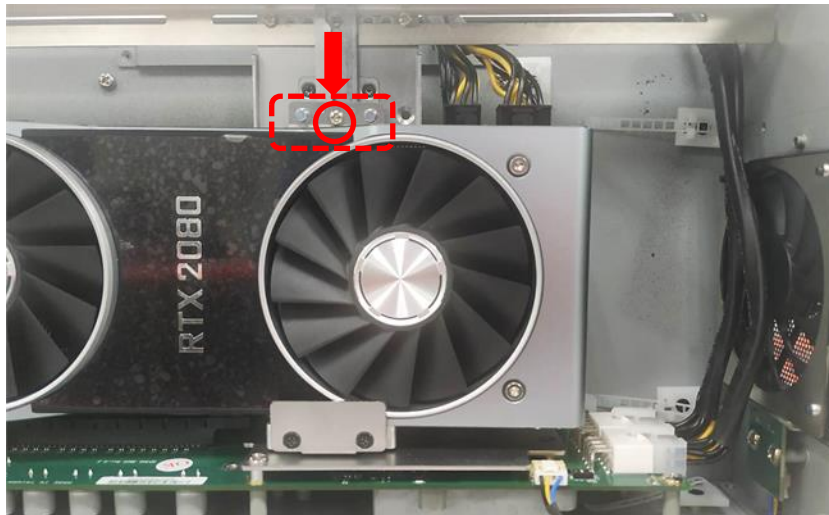

17. Fasten the screw (M3X5L).



18. Use the cable tie to tie the two wires together.

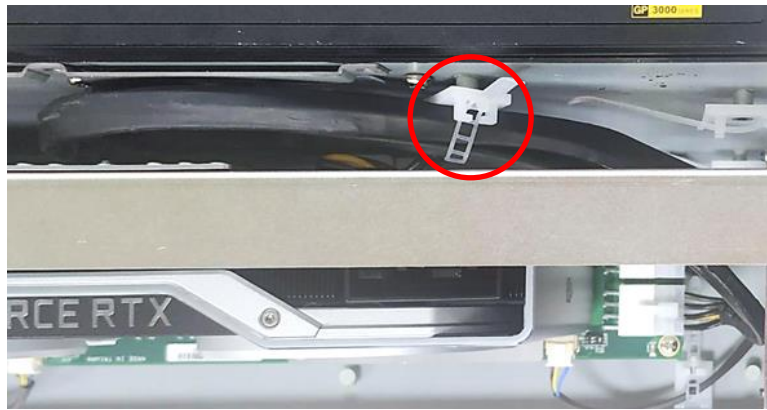

19. Press the wire and tape to close to the fan side and meanwhile push the fan seat back to the module. Fasten the screw and execute the installation step 7~ 8 in chapter 6.6.1 in the end.

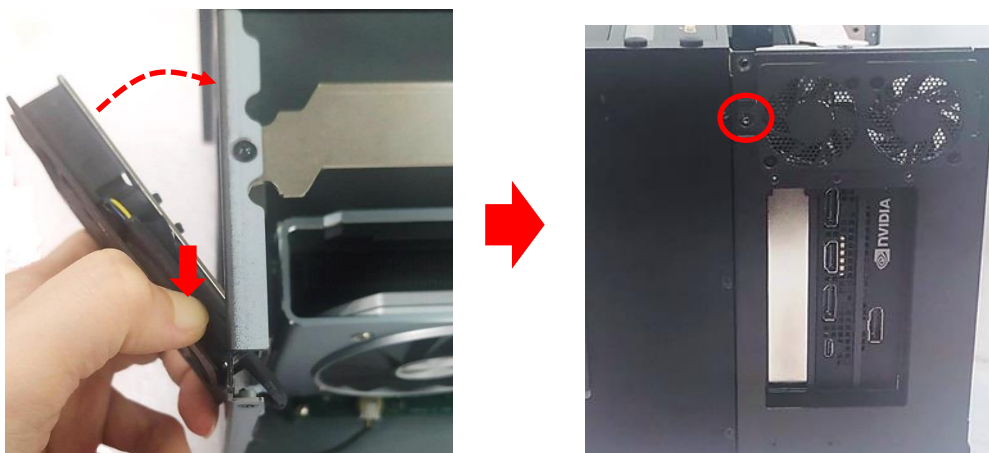

CAUTION

This step is important! Failure to follow this step may scratch and damage the wire.

6.6.3 Installing Rubber Foot Pad

1. Locate the two screw holes on the side panel of GEB-3301-R10.



2. Attach on the two rubber foot pads and fasten the two screws to fix them.



6.6.4 Installing Wall Mount

GP-3000 with GEB-3301-R10 Module provides a wall mount kit that customers can install system on the wall in a convenient and economical way.

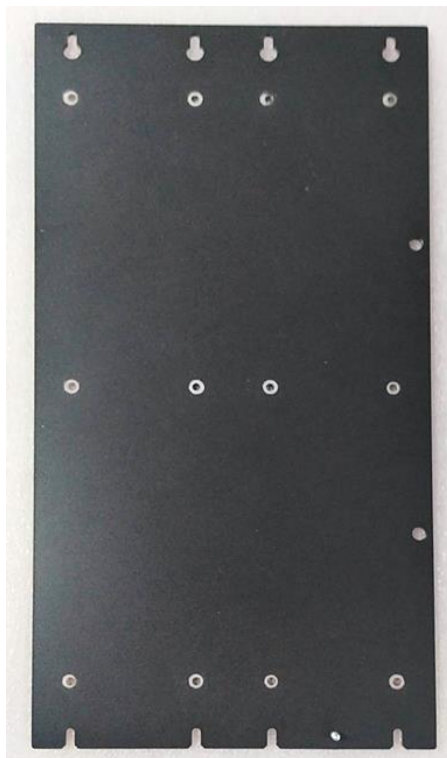

1. After completing all the installation steps in chapter 6.6.1, attach the wall mount bracket onto the system according to the orientation shown below.



2. Use provided 12 screws to fasten the bracket.

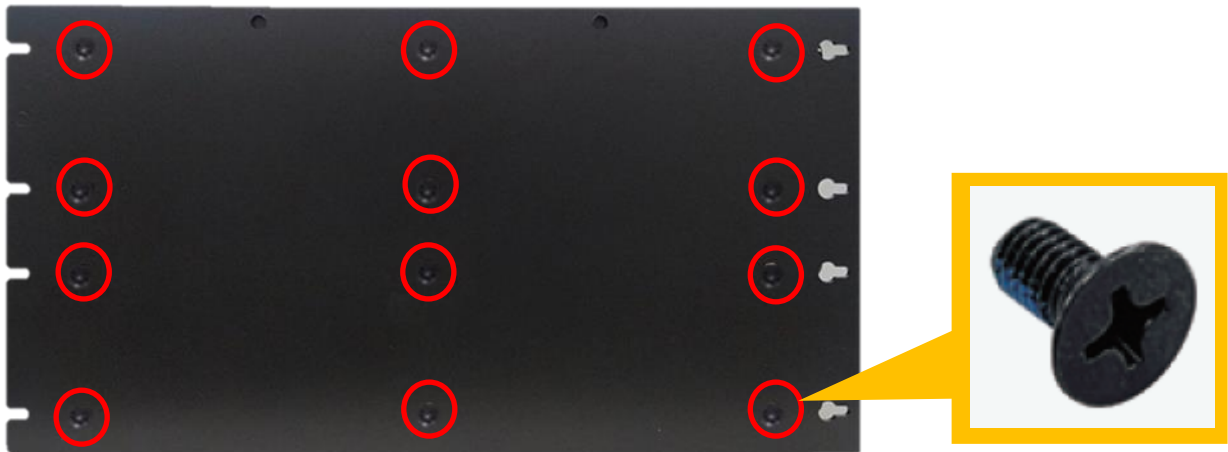

3. The 4 bracket mounting holes are used to fix the system on the wall.



6.6.5 Installing 19" Rack Mount

GP-3000 with GEB-3301-R10 Module provides the 19" Rack Mount kit that customers can install the system onto 19" Rack.



Before installing GP-3000/GEB-3301-R10 onto the 19" Rack Mount, please follow the steps below to assemble the 19" Rack Mount kit first.

- (1) Locate the four screw holes.



- (2) Attach the two handles onto the seat bracket, and fasten the four screws (M5X12) to fix them from the back side.



(3) Place the back panel onto the seat bracket as the indicated direction

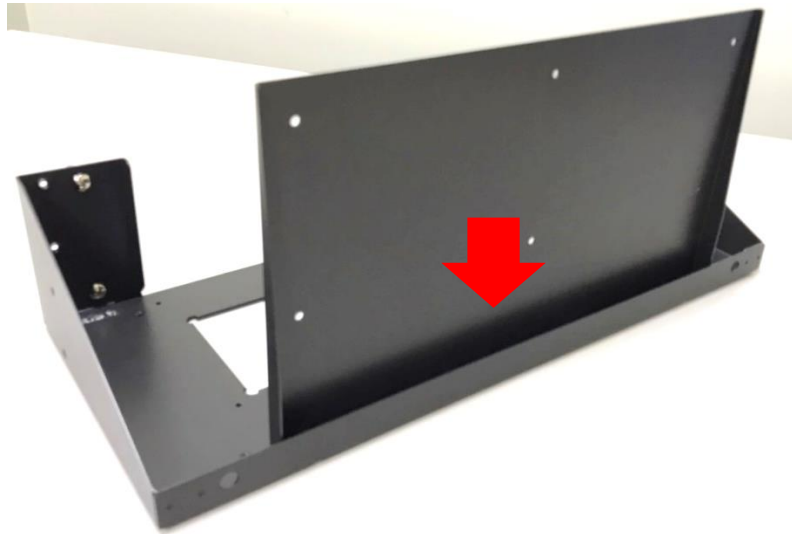

(4) Turn to the bottom side of the seat bracket, and fasten the four screws (M4X6L) to fix the back panel.



1. Get assembled GP-3000/GEB-3301-R10 ready. Loosen the four screws on the front panel of the GEB-3301-R10 module.



2. Place the GP-3000/GEB-3301-R10 into the assembled 19" Rack Mount kit.



3. Turn to the bottom side of the 19" Rack Mount kit, and fasten the four screws (M3X8L).



4. Turn to the back side of the 19" Rack Mount kit, and fasten the 6 screws (M4X6L).

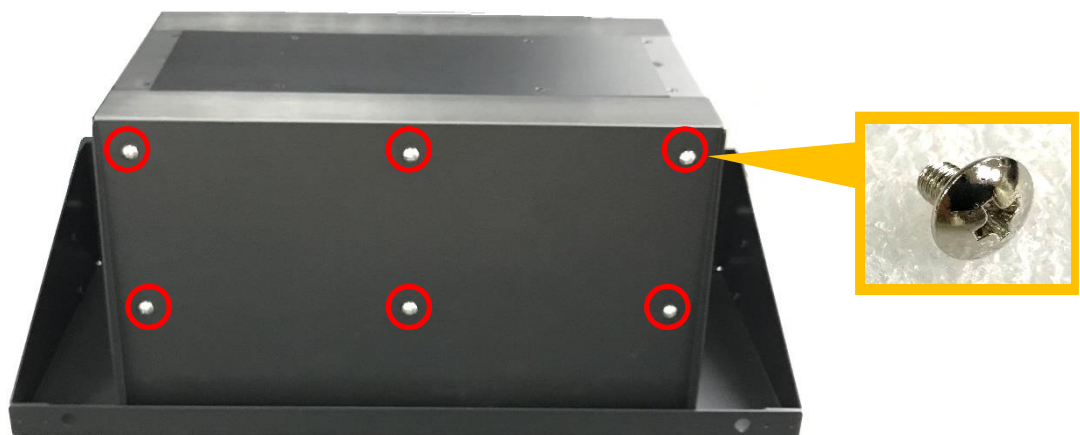

5. Install the GP-3000/GEB-3301-R10 with the 19" Rack Mount kit onto the 19" Rack by fastening the 4 screws to complete the installation.



6.7 Installing GEB-3601-R10 Module

6.7.1 Installing GEB-3601-R10 Module onto GP-3000

1. Locate the rear panel of the module. Remove the protective shell on the riser card.



2. Loosen the screws on the panels of the module.

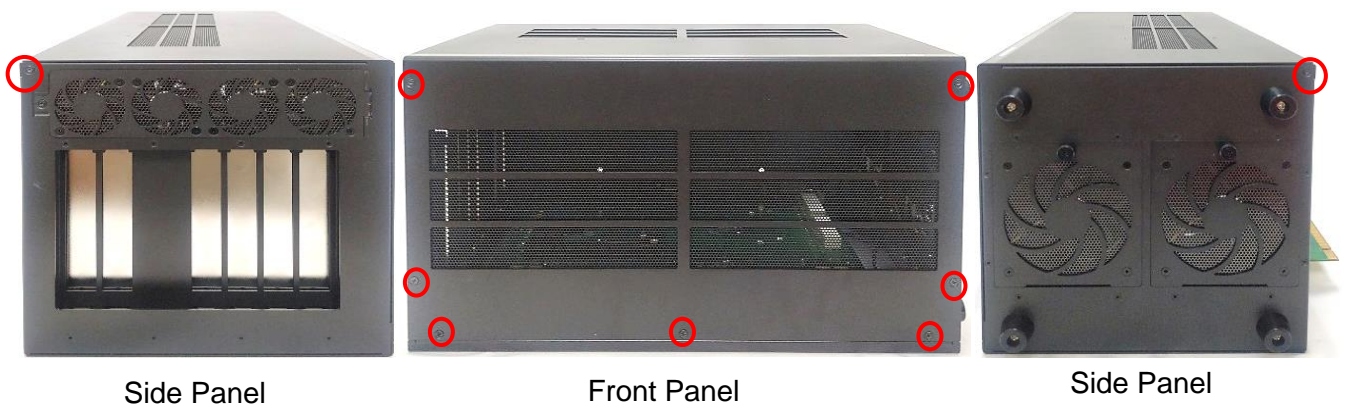

3. Turn to the rear panel. Press the left side of the top panel, and lift the right side of the top panel up at about 30 degrees. Then keep the angle, gently and horizontally pull the top panel away.

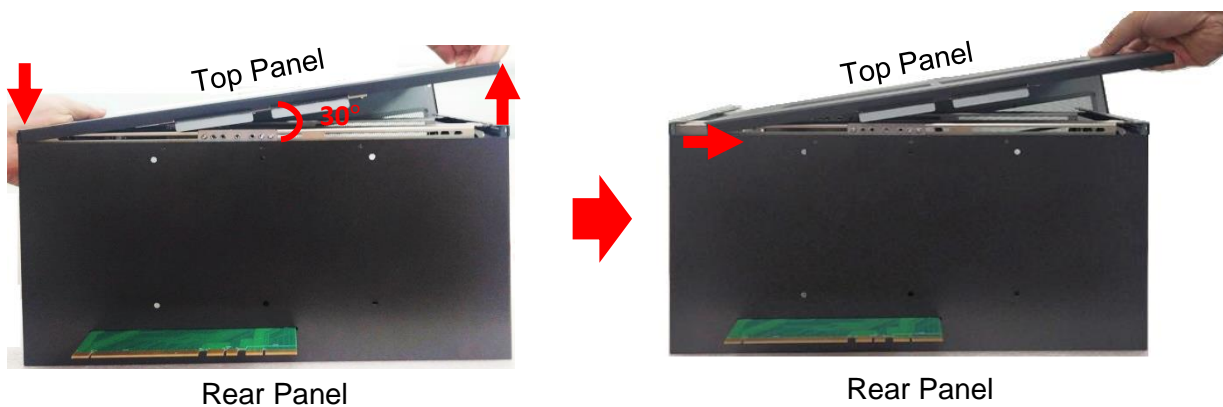

WARNING

This step is very important! Failure to follow this step will damage the fan power connector.

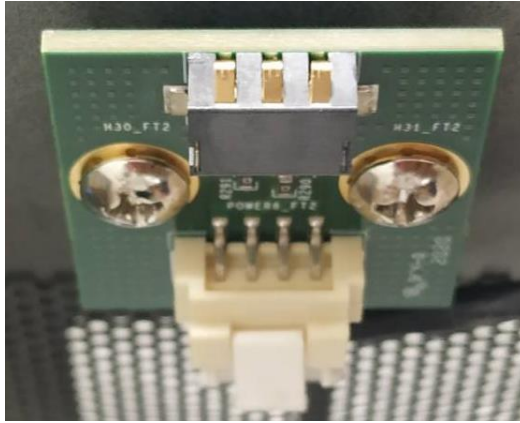

Fan Power Connector on GEB-3601-R10

4. Loosen the two screws on the bottom side of GP-3000 and remove the bracket.

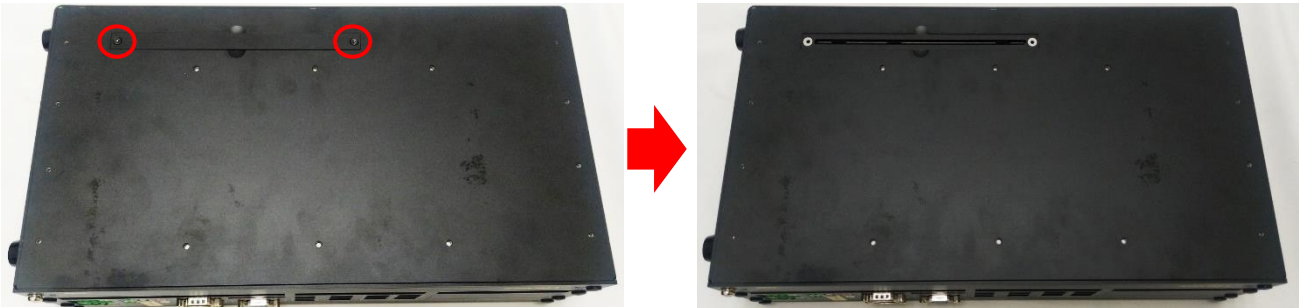

5. Hold the module, align the riser card's golden pins with the socket of GP-3000. Insert the riser card to the socket of GP-3000, and ensure the module is firmly connected to GP-3000.

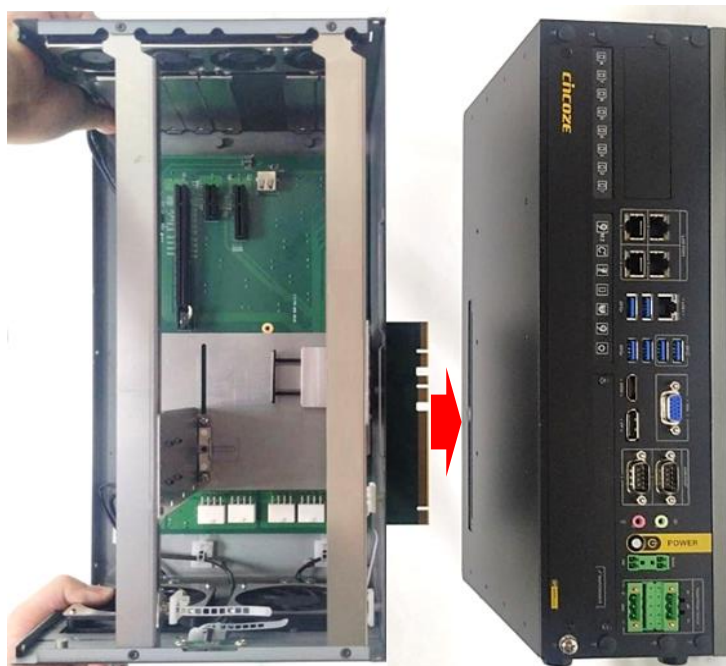

6. Fasten the six screws.

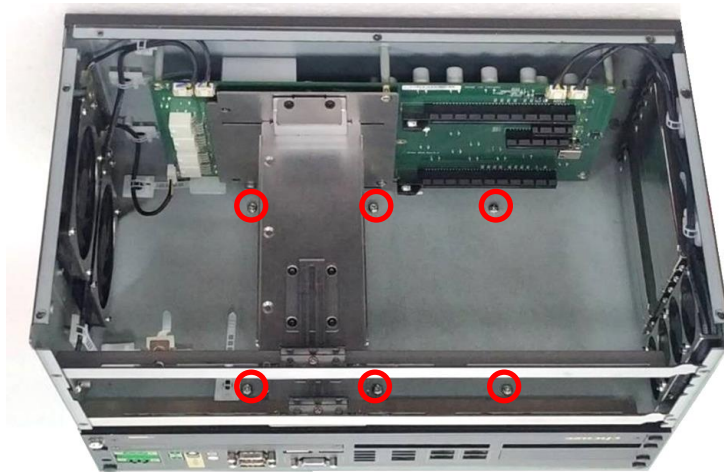

7. Assembling the top panel back to the module.

7.1 Press the left side and hold the right side of the module's top panel at about 30 degrees as the picture below.



7.2 Keep holding the left side of the module's top panel, and press down the location on the panel as indicated.



7.3 Keep holding the left side of the module's top panel, and press down the location on the panel as indicated.



WARNING

This step is very important! Failure to follow this step will damage the fan power connector.

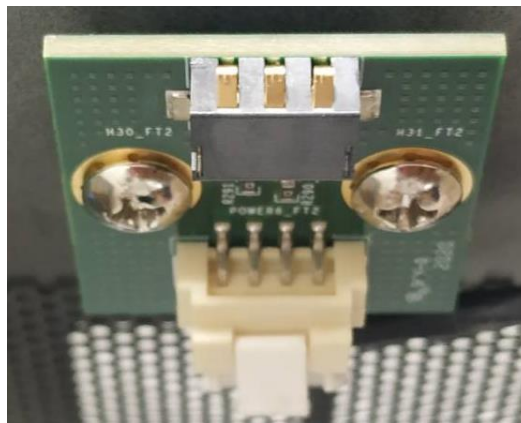

Fan Power Connector on GEB-3601-R10

8. Fasten the 9 screws on the panels.



Side Panel

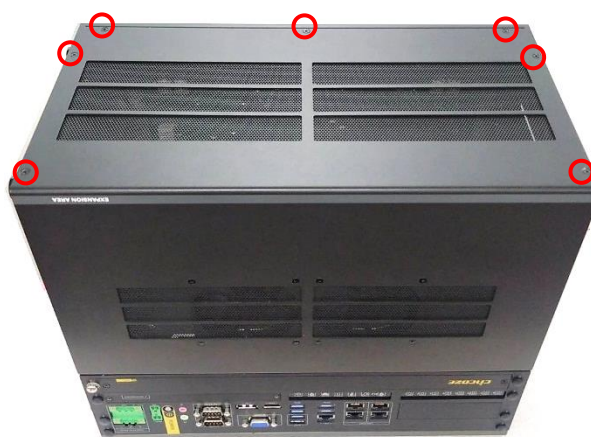

Front Panel



Side Panel

6.7.2 Installing GPU Card



NOTE

GEB-3601 maximum power budget for its two PCIe16 slots is 500W. When only one PCIe16 slot is connected, it has maximum power budget of 350W. When two PCIe16 slots are connected, each slot has maximum power budget of 250W.

1. Please execute the installation step 1 to step 6 in chapter 6.7.1 first, and then loosen the screw on the module's side panel.

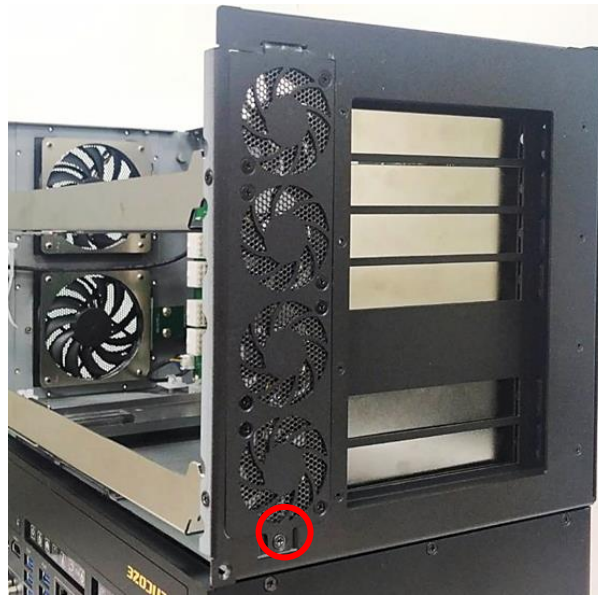

2. Press the wire and tape to close to the fan side, and then push out the fan seat.



CAUTION

This step is important! Failure to follow this step may scratch and damage the wire.

3. Loosen the screw(s) to remove the I/O bracket(s).

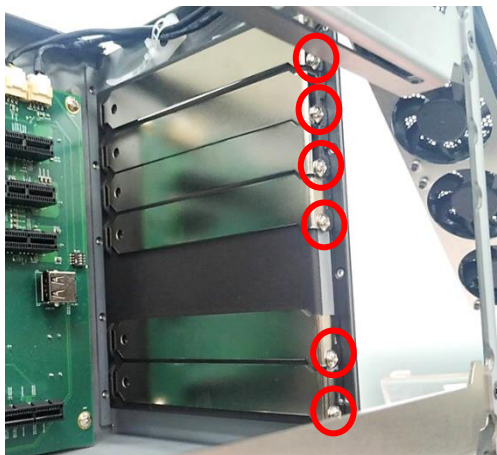

4. Loosen but not remove the four screws.



Front View

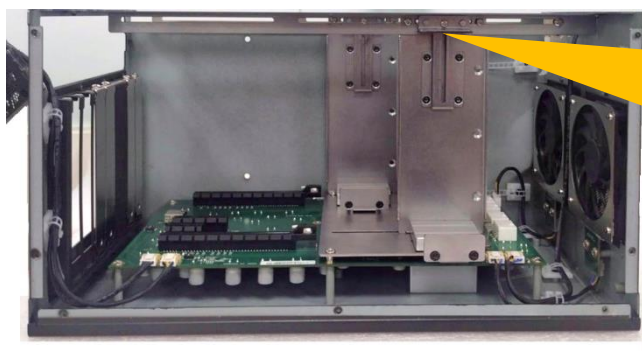
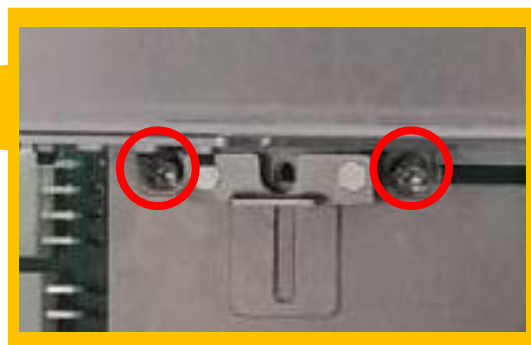

Top View

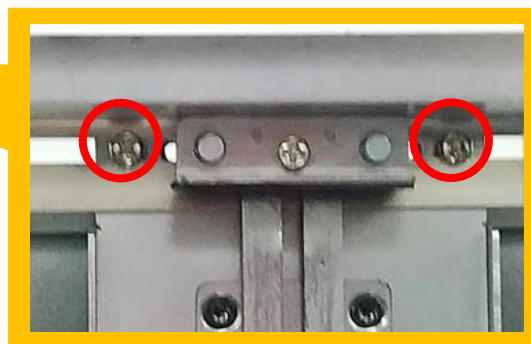

5. Move the card retainer to an appropriate place according to the GPU card's dimension.

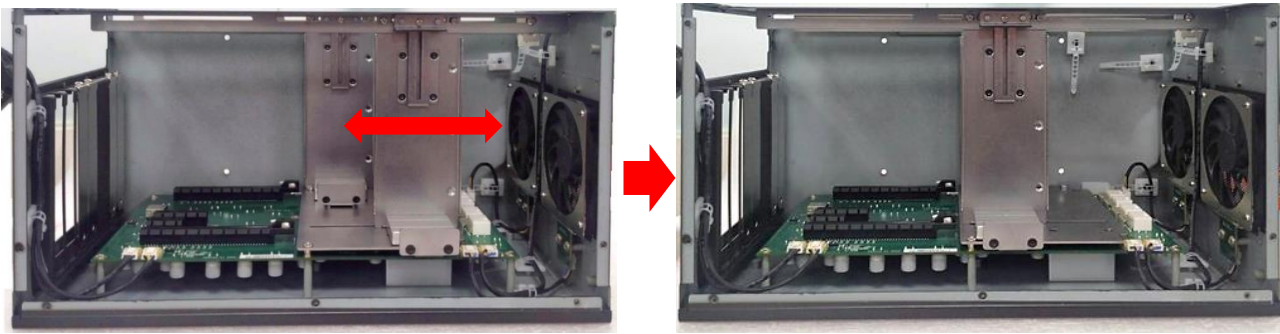

6. Loosen the two screws and move the plate to an appropriate place according to the GPU card's dimension. The length of the pre-installed screws is 35 mm. User can also replace these screws with screws of two other lengths (45 mm/ 25 mm) according to the GPU card's dimension.

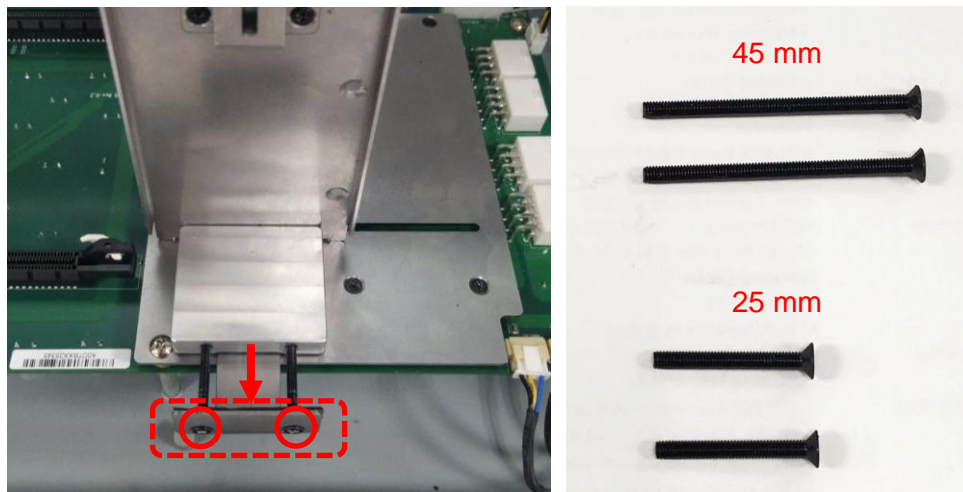

7. Insert the GPU power cables into the power connectors (red set or blue set) as indicated.

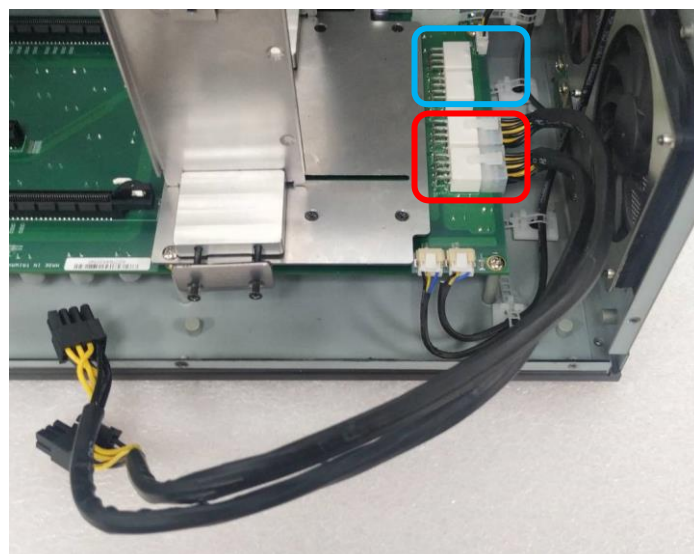

8. Insert the other ends of the two wires into the connector on the GPU card. The plug of the wire is a flexible design and can be connected to the 6-pin or 8-pin connector. (The picture shown below is just an example, the actual connection should be made according to user's GPU card.)

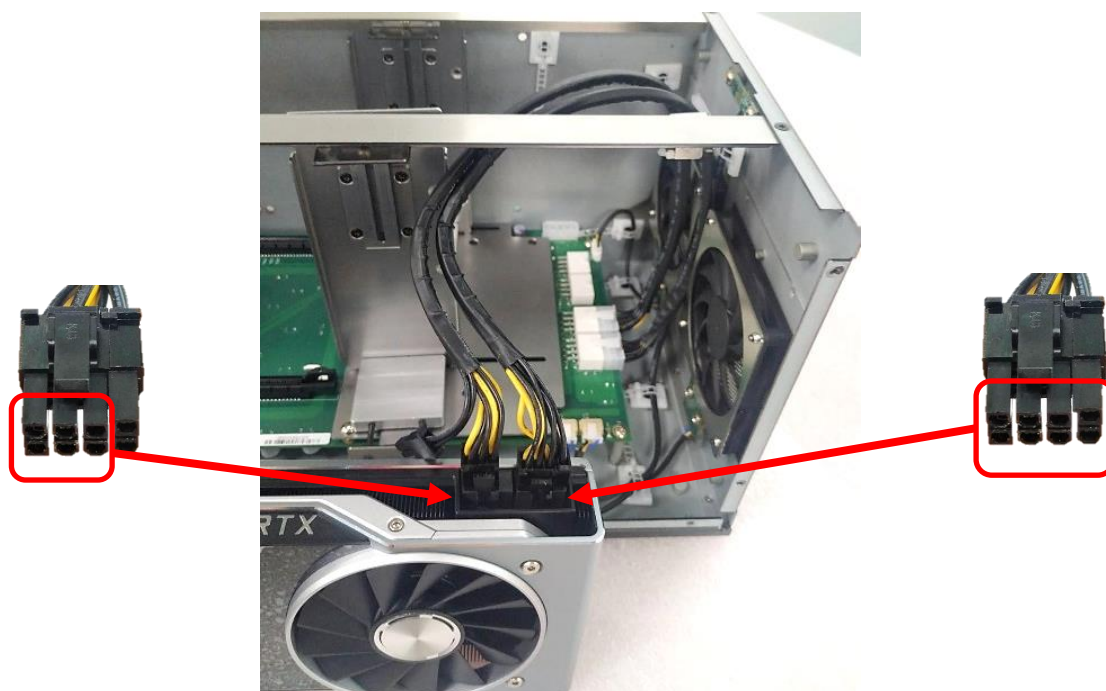

9. If there is exposed PCB on the GPU card which may touch the card retainer, please paste the black sponge bars on the lateral sides of card retainer before inserting GPU card into the module. If not, please skip this step and directly go to the step 10.

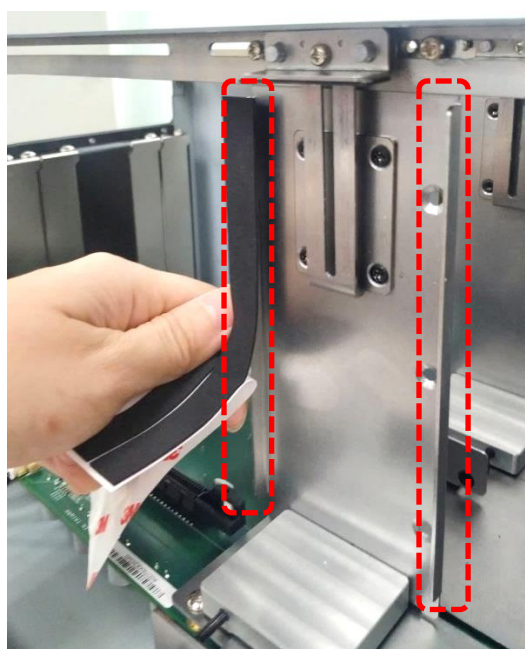

10. Insert GPU card into the PCIe socket.

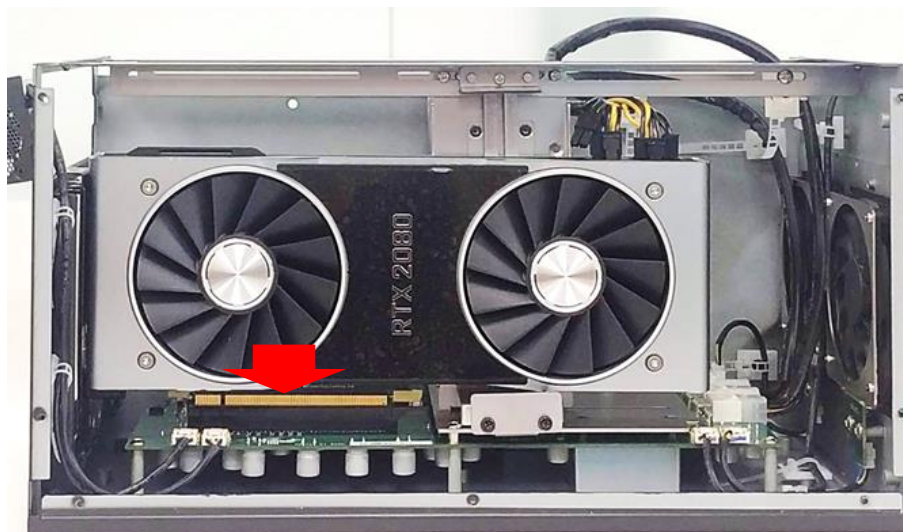

11. Fasten the screws back.



12. Fasten the four screws to fix the card retainer.

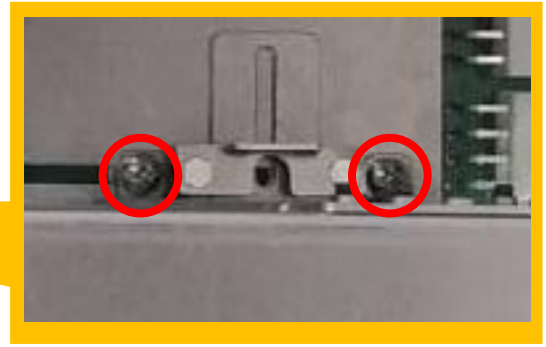

Front View

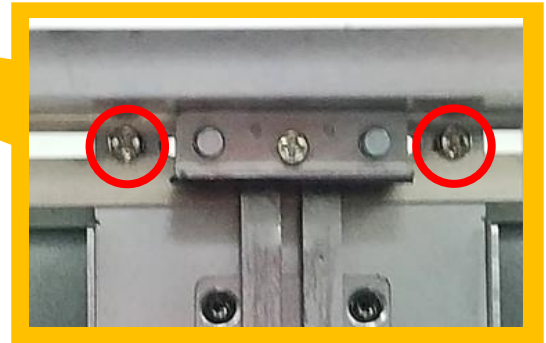
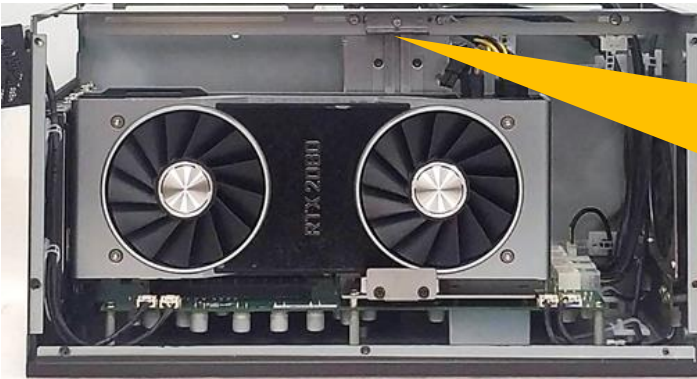

Top View

13. Push the plate till it contacts the GPU card, and then fasten the two screws to fix the GPU card

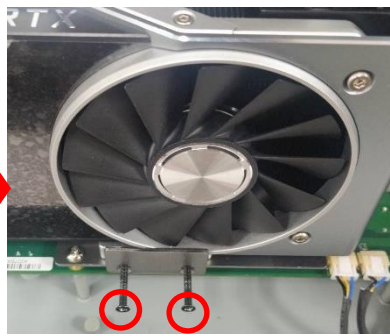
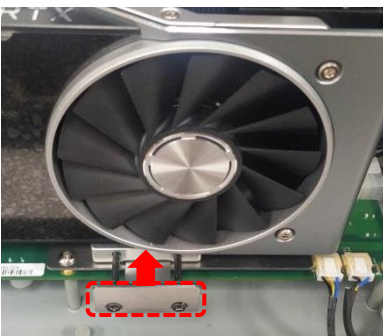

14. Fasten the screw (M3X6L) to fix the card retainer.

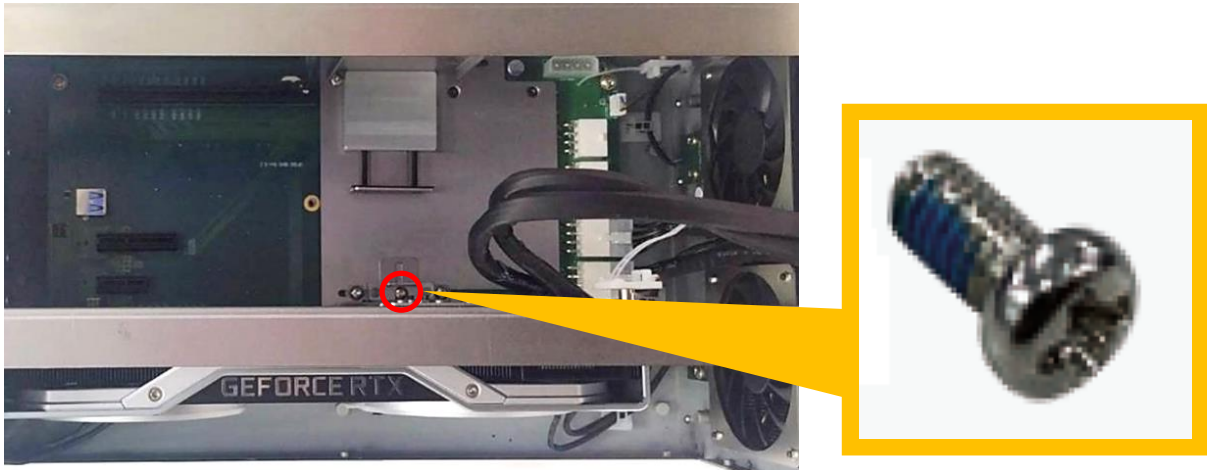

NOTE

It is normal that the GPU card might be too thick to fasten the screw to the hole.

15. Loosen but not remove the screw.

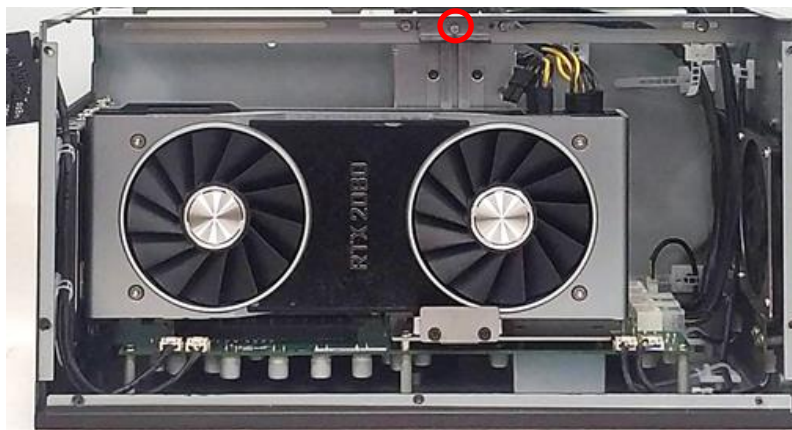

16. Make sure that the metal plate slides down until it touches the GPU card, and then fasten the screw to fix the GPU card.

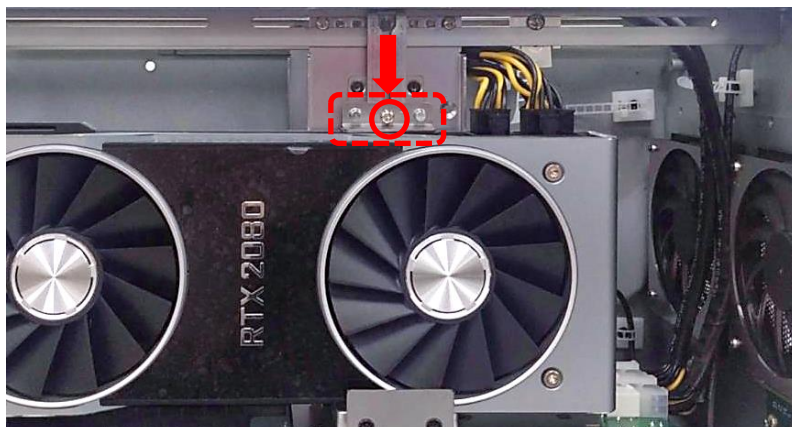

17. Fasten the screw (M3X5L).

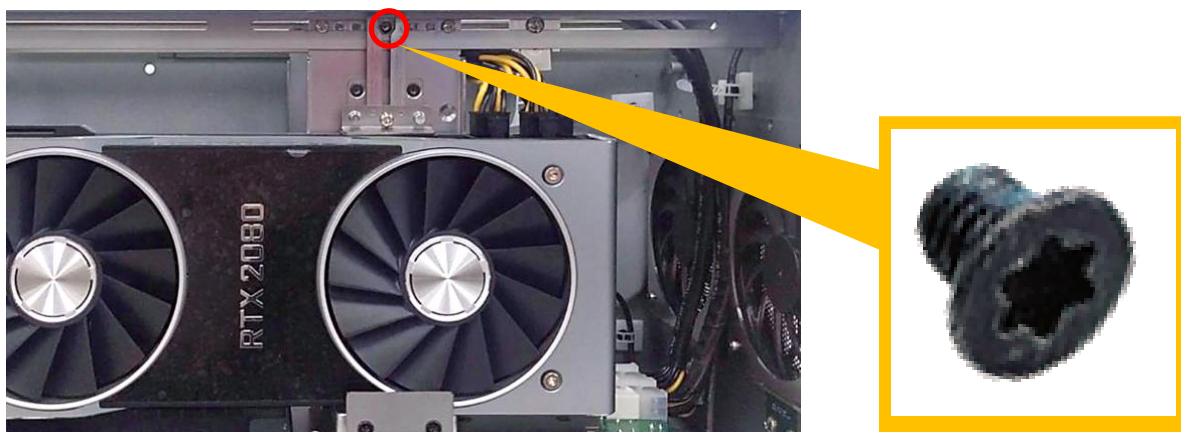

18. Loosen but not remove the screw in order to move the cable tie seat to an appropriate place.

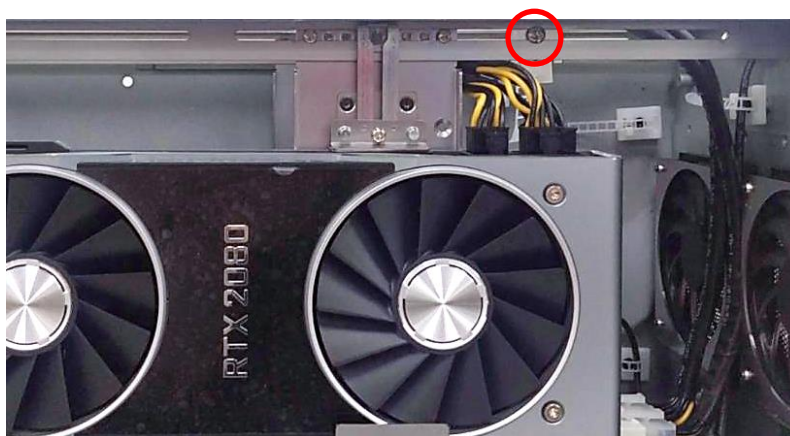

19. Use the cable tie to tie the two wires together.

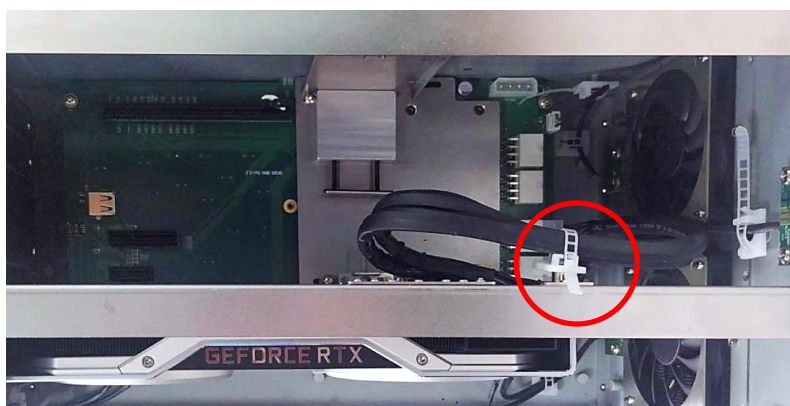

20. Press the wire and tape to close to the fan side and meanwhile push the fan seat back to the module. Fasten the screw and execute the installation step 7~ 8 in chapter 6.7.1 in the end.

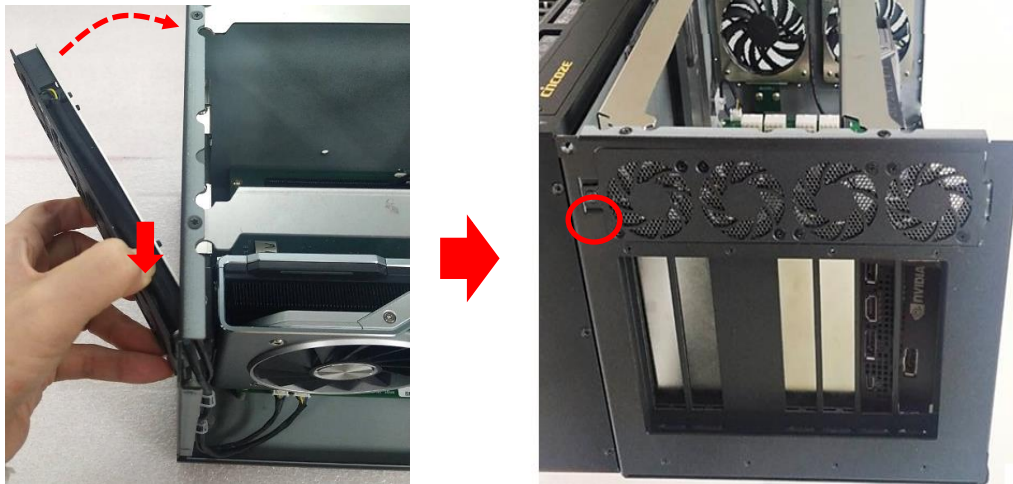

CAUTION

This step is important! Failure to follow this step may scratch and damage the wire.

6.7.3 Installing Rubber Foot Pad

1. Locate the two screw holes on the side panel of GEB-3601-R10.



2. Attach on the two rubber foot pads and fasten the two screws to fix them.

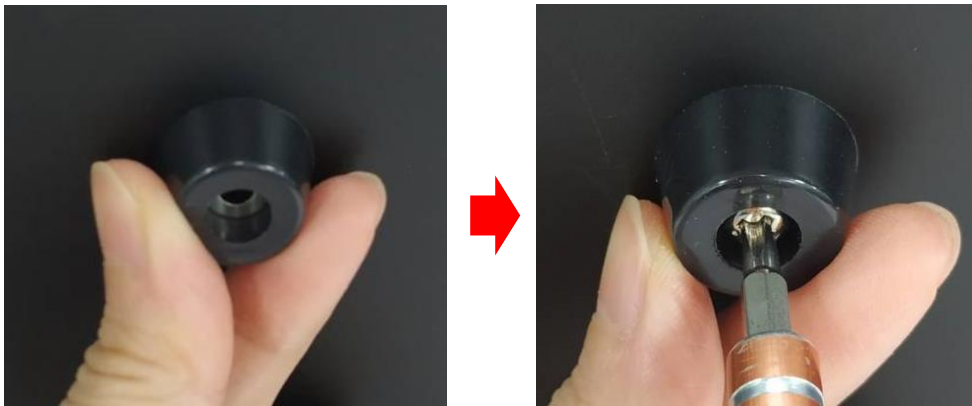

6.7.4 Installing Wall Mount

GP-3000 with GEB-3601-R10 Module provides a wall mount kit that customers can install system on the wall in a convenient and economical way.

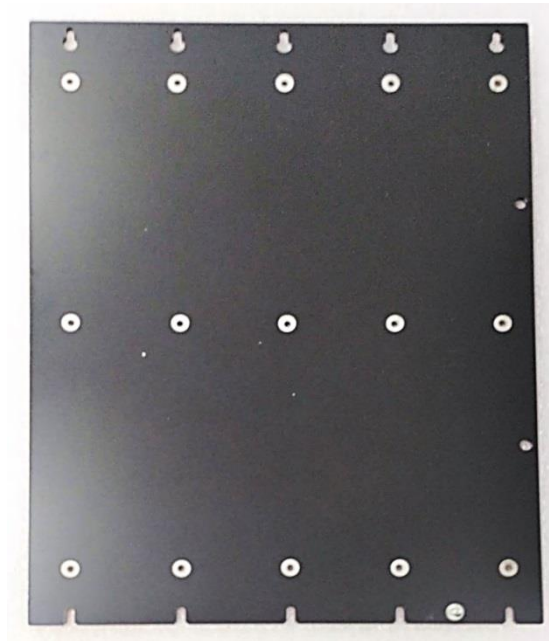

1. After completing all the installation steps in chapter 6.7.1, attach the wall mount bracket onto the system according to the orientation shown below.



2. Use provided 15 screws to fasten the bracket.

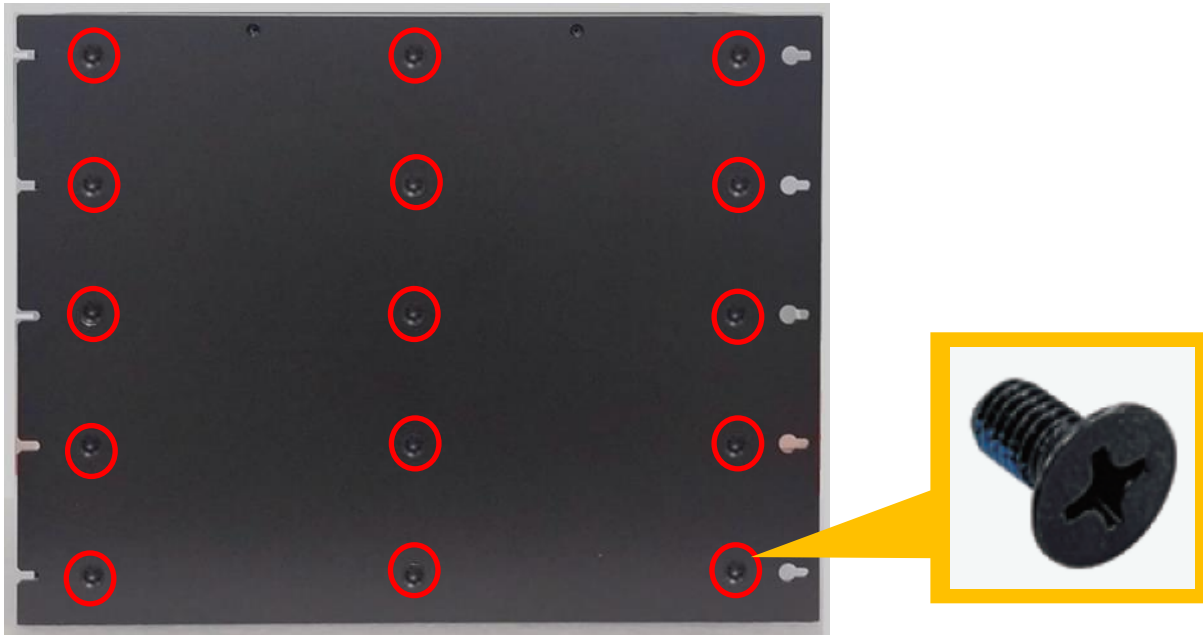

3. The 10 bracket mounting holes are used to fix the system on the wall.



6.7.5 Installing 19" Rack Mount

GP-3000 with GEB-3601-R10 Module provides the 19" Rack Mount kit that customers can install the system onto the 19" Rack.



Before installing GP-3000/GEB-3601-R10 onto the 19" Rack Mount, please follow the steps below to assemble the 19" Rack Mount kit first.

- (1) Locate the four screw holes



- (2) Attach the two handles onto the seat bracket, and fasten the four screws (M5X12) to fix them from the back side.

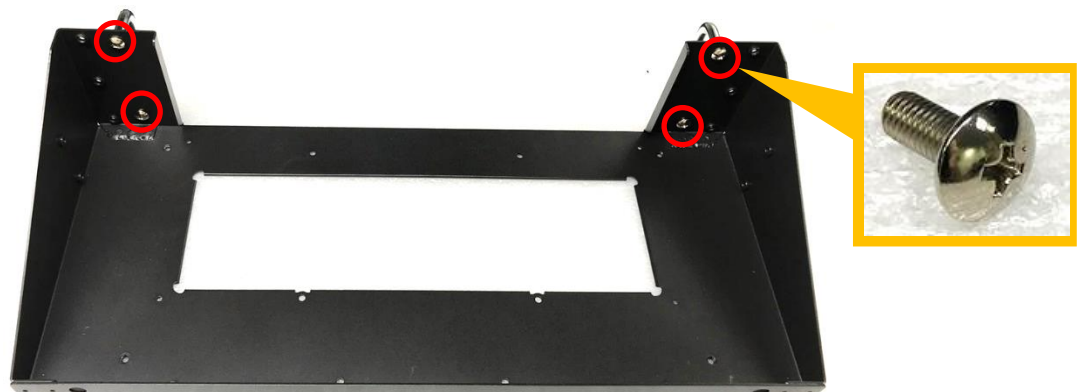

(3) Place the back panel onto the seat bracket as the indicated direction

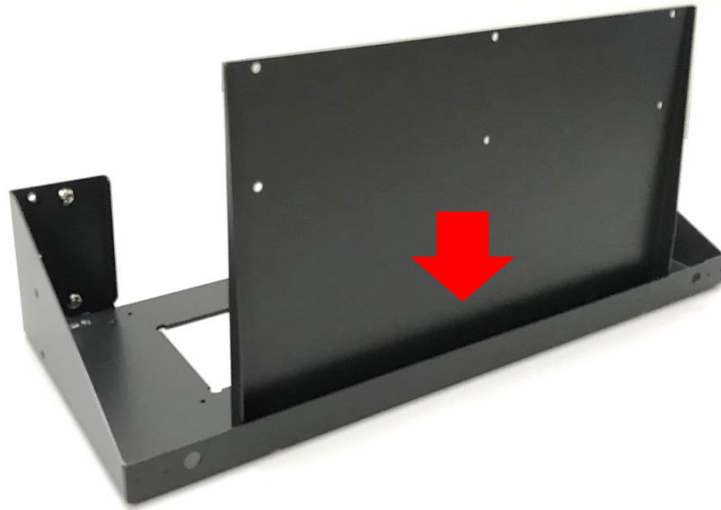

(4) Turn to the bottom side of the seat bracket. Fasten the four screws (M4X6L) to fix the back panel.

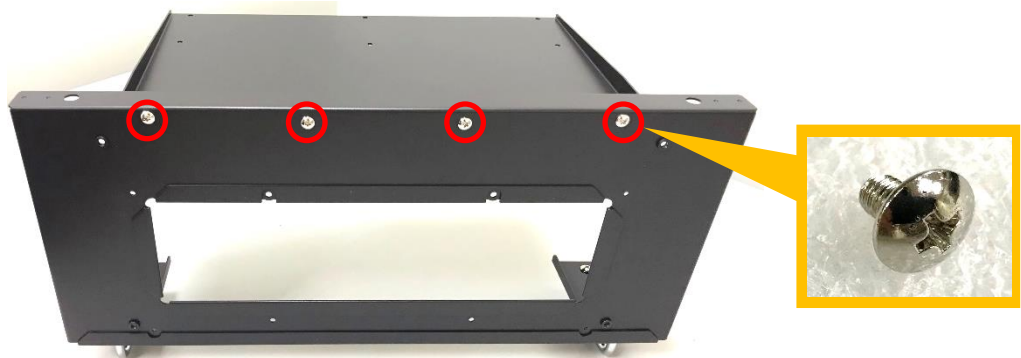

1. Get the assembled GP-3000/GEB-3601-R10 ready. Loosen the four screws on the front panel of the GEB-3601-R10 module.



2. Place the GP-3000/GEB-3601-R10 into the assembled 19" Rack Mount kit.



3. Turn to the bottom side of the 19" Rack Mount kit, and fasten the four screws (M3X8L).

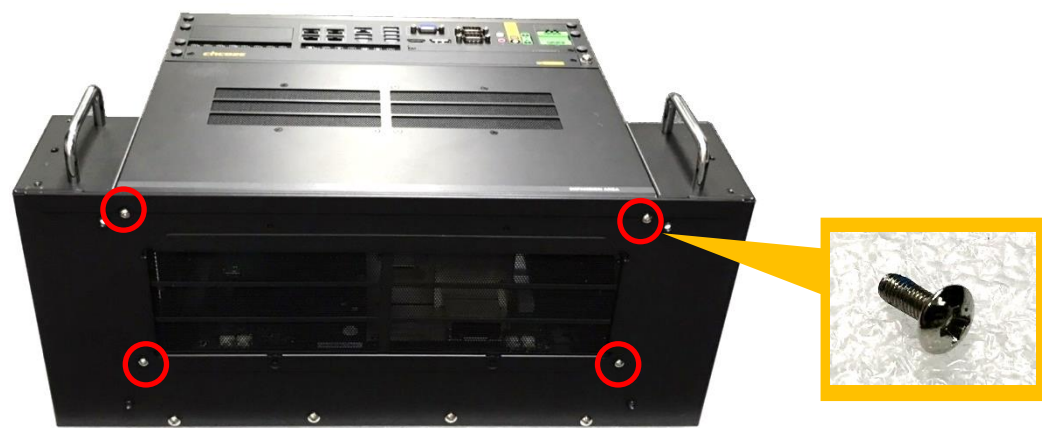

4. Turn to the back side of the 19" Rack Mount kit, and fasten the 6 screws (M4X6L).

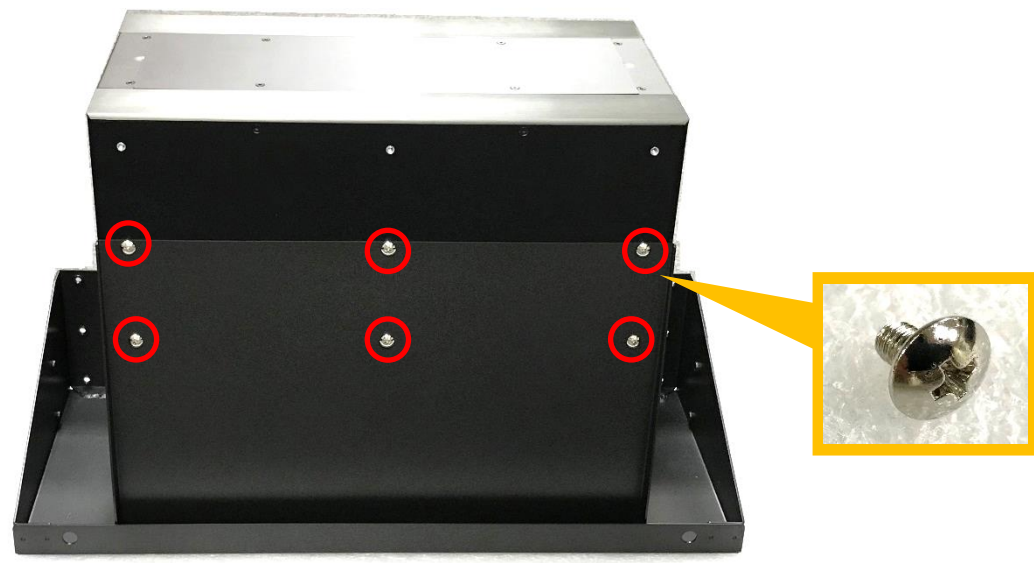

5. Install the GP-3000/GEB-3601-R10 with the 19" Rack Mount kit onto the 19" Rack by fastening the 4 screws to complete the installation.



6.8 Power Supply Cabling Guide

6.8.2 Cabling with US Power Cord

1. Locate the AC end socket on the SDR-480-24 power supply.



2. Insert the US Power Cord and fasten the screws to fix it as indicated.

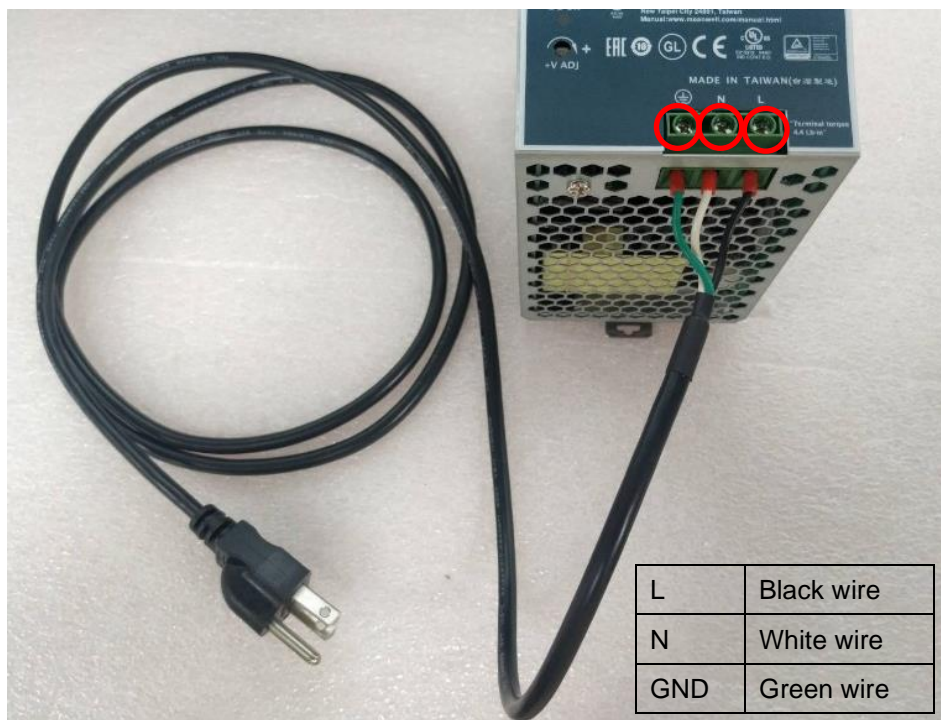

3. Locate the DC end socket on the SDR-480-24 power supply.



4. Connect the black wire to either “-V” socket, and connect the white wire to either “+V” socket.



5. Follow the steps in chapter 3-14 to complete the installation.



6.8.3 Cabling with EU Power Cord

1. Locate the AC end socket on the SDR-480-24 power supply.



2. Insert the EU Power Cord and fasten the screws to fix it as indicated.

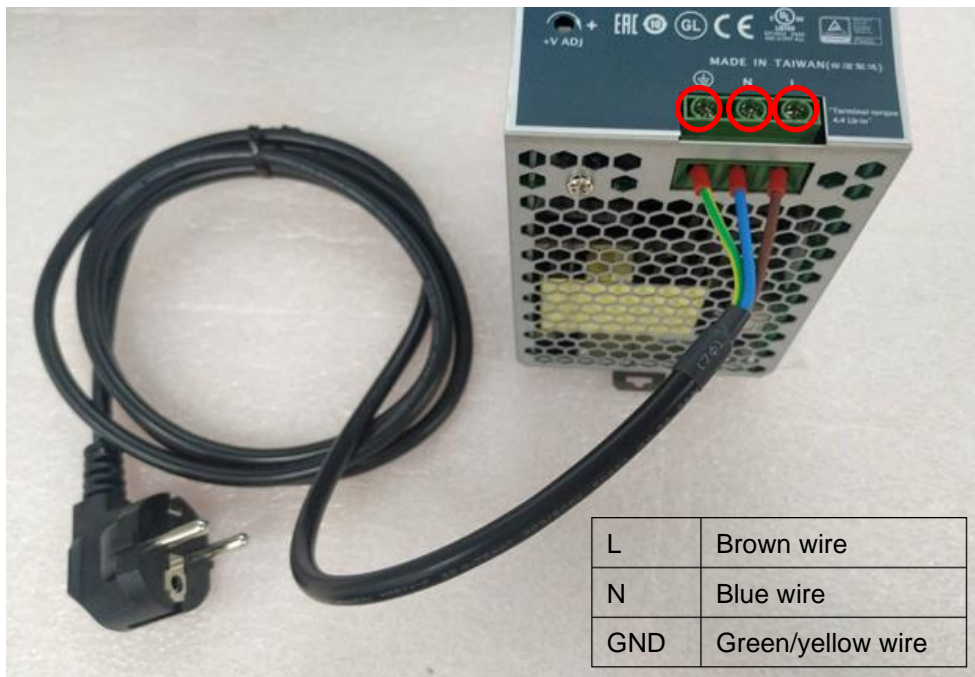

3. Locate the DC end socket on the SDR-480-24 power supply.



4. Connect the black wire to either “-V” socket, and connect the white wire to either “+V” socket.

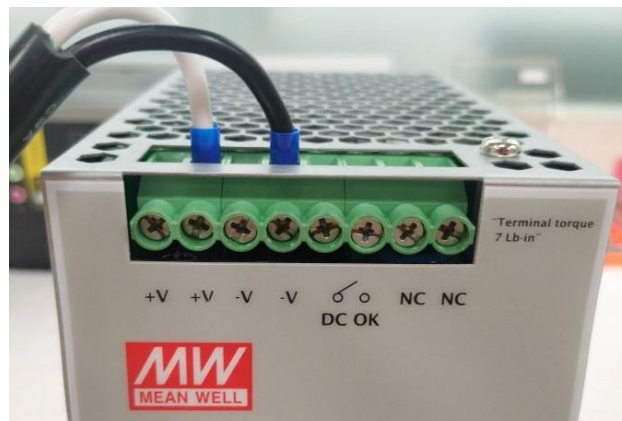

6. Follow the steps in chapter 3-14 to complete the installation.



cincoze

© 2021 Cincoze Co., Ltd. All rights reserved.

The Cincoze logo is a registered trademark of Cincoze Co., Ltd.

All other logos appearing in this catalog are the intellectual property of the respective company, product, or organization associated with the logo.

All product specifications and information are subject to change without notice.