



MODEL:
IDS-310AI

Embedded System with Intel® Celeron® J3455 Processor, Three HDMI, 128 GB SATA DOM, USB 3.2 Gen 1, Dual GbE, VPU Accelerator, RS-232/422/485 and RoHS Compliant

User Manual

Revision

Date	Version	Changes
September 28, 2020	1.00	Initial release

Copyright

COPYRIGHT NOTICE

The information in this document is subject to change without prior notice in order to improve reliability, design and function and does not represent a commitment on the part of the manufacturer.

In no event will the manufacturer be liable for direct, indirect, special, incidental, or consequential damages arising out of the use or inability to use the product or documentation, even if advised of the possibility of such damages.

This document contains proprietary information protected by copyright. All rights are reserved. No part of this manual may be reproduced by any mechanical, electronic, or other means in any form without prior written permission of the manufacturer.

TRADEMARKS

All registered trademarks and product names mentioned herein are used for identification purposes only and may be trademarks and/or registered trademarks of their respective owners.



Safety Instructions

- en** Warning! Read the user manual before connecting the system to the power source.
- de** Vorsicht! Bitte lesen Sie die Bedienungsanleitung, bevor Sie das System an eine Stromquelle anschließen.
- fr** Attention! Avant de brancher le système à la source d'alimentation, consultez le mode d'emploi.
- it** Avvertenza! Consultare il manuale utente prima di collegare il sistema all'alimentatore.
- es** Atención! Lea atentamente este manual del usuario antes de operar la fuente de alimentación.
- zh** 警告！在將系統連接到電源之前，請仔細閱讀使用手冊。
- cn** 警告！在將系統連接到電源之前，請仔細閱讀使用手冊。
-

- en** Warning! To prevent the system from overheating, do not operate it in an area that exceeds the maximum operating temperature described in the user manual.
- de** Vorsicht! Um eine Überhitzung des Systems zu vermeiden, betreiben Sie es ausschließlich im zulässigen Betriebstemperaturbereich. Dieser ist in der Bedienungsanleitung vermerkt.
- fr** Attention! Pour éviter la surchauffe du système, ne l'utilisez pas dans une zone dont la température dépasse les limites décrits dans le mode d'emploi.
- it** Avvertenza! Per evitare che il sistema si surriscaldi, non utilizzarlo in aree che superino la temperatura massima d'esercizio descritta nel manuale utente.
- es** Atención! Para evitar el excesivo calentamiento del sistema, no opere en las condiciones de temperatura superior a lo recomendado en este manual del usuario.
- zh** 警告！為防止系統過熱，不要在超過使用手冊上記載的產品工作溫度範圍之外操作此系統。
- cn** 警告！為防止系統過熱，不要在超過使用手冊上記載的產品工作溫度範圍之外操作此系統。
-

IDS-310AI Embedded System

- en** Warning! Use only the adapter and power cord approved for this system. Use of another type of adapter may risk fire or explosion. Please refer to the user manual for the power adapter specifications.
- de** Vorsicht! Nur zugelassene Netzteile und Netzkabel dürfen verwendet werden. Die Benutzung von anderen Netzteilen kann einen Brand oder eine Explosion zur Folge haben. Prüfen Sie die jeweiligen Spezifikationen in der Bedienungsanleitung.
- fr** Attention! Utilisez exclusivement le câble d'alimentation et l'adaptateur homologués pour ce système. L'utilisation d'un autre type d'adaptateur risquerait de provoquer un incendie ou une explosion. Veuillez référer au mode d'emploi pour les spécifications de l'adaptateur d'alimentation.
- it** Avvertenza! Utilizzare solo l'adattatore e il cavo di alimentazione approvati per questo sistema. L'uso di un altro tipo di adattatore può causare rischio d'incendio o esplosione. Si prega di fare riferimento al manuale utente per le specifiche sull'alimentazione.
- es** Atención! Utilice solamente el adaptador de corriente alterna (CA) con Marcas Conformidad otorgadas. Cualquier otro adaptador no otorgado aumenta el riesgo de explosión o incendio. Por favor consulte el manual del usuario para las especificaciones del adaptador de alimentación.
- zh** 警告！只能使用經過認證、適用於本系統的電源變壓器與電源線。使用不適用的電源變壓器將可能導致火災或爆炸。電源變壓器規格請參考使用手冊。
- cn** 警告！只能使用经过认证，适用于本系统的电源适配器与电源线。使用不适用的电源适配器将可能导致火灾或爆炸。电源适配器规格请参考使用手冊。

-
- en** Warning! Ultimate disposal of this product should be handled according to all national laws and regulations.
- de** Vorsicht! Die Entsorgung dieses Produkts sollte gemäß allen Bestimmungen und Gesetzen des Landes erfolgen.
- fr** Attention! La mise au rebut ou le recyclage de ce produit sont généralement soumis aux lois et/ou directives de respect de l'environnement. Renseignez-vous auprès de l'organisme compétent.
- it** Avvertenza! Lo smaltimento di questo prodotto deve essere eseguito secondo le leggi e i regolamenti locali.
- es** Atención! La disposición final de residuos de este producto se debe cumplir con las normativas y leyes del país.
- zh** 警告！本產品的廢棄處理應根據該國家的法律和規章進行。
- cn** 警告！本产品的废弃处理应根据该国家的法律和规章进行。
-

Manual Conventions



WARNING

Warnings appear where overlooked details may cause damage to the equipment or result in personal injury. Warnings should be taken seriously.



CAUTION

Cautionary messages should be heeded to help reduce the chance of losing data or damaging the product.



NOTE

These messages inform the reader of essential but non-critical information. These messages should be read carefully as any directions or instructions contained therein can help avoid making mistakes.



HOT SURFACE

This symbol indicates a hot surface that should not be touched without taking care.

Table of Contents

1 INTRODUCTION.....	1
1.1 OVERVIEW.....	2
1.2 FEATURES.....	2
1.3 I/O PANELS.....	3
1.4 SIDE PANEL	4
1.5 TECHNICAL SPECIFICATIONS	4
1.6 DIMENSIONS.....	6
2 UNPACKING	7
2.1 UNPACKING.....	8
2.2 PACKING LIST.....	8
2.3 OPTIONAL ITEMS	9
3 INSTALLATION	10
3.1 ANTI-STATIC PRECAUTIONS	11
3.2 INSTALLATION PRECAUTIONS	11
3.2.1 <i>High Surface Temperature</i>	12
3.3 BOTTOM SURFACE REMOVAL	12
3.4 WIRELESS LAN MODULE INSTALLATION (OPTIONAL)	14
3.5 AT/ATX POWER MODE SELECTION	17
3.6 MOUNTING THE SYSTEM	18
3.7 EXTERNAL PERIPHERAL INTERFACE CONNECTION	19
3.7.1 <i>LAN Connectors</i>	20
3.7.2 <i>HDMI Connectors</i>	21
3.7.3 <i>Power Connector</i>	22
3.7.4 <i>RS-232/422/485 Serial Port Connector</i>	23
3.7.5 <i>USB 3.2 Gen 1 (5Gb/s) Connectors</i>	24
3.8 POWER-ON PROCEDURE.....	25
3.8.1 <i>Installation Checklist</i>	25
3.8.2 <i>Power-on Procedure</i>	25
3.9 RESET THE SYSTEM	26

3.10 CLEAR CMOS.....	26
3.11 FLASH DESCRIPTOR SECURITY OVERRIDE.....	27
4 BIOS.....	28
4.1 INTRODUCTION.....	29
4.1.1 Starting Setup.....	29
4.1.2 Using Setup.....	29
4.1.3 Getting Help.....	30
4.1.4 BIOS Menu Bar.....	30
4.2 MAIN.....	31
4.3 ADVANCED.....	32
4.3.1 Trusted Computing.....	32
4.3.2 ACPI Settings.....	34
4.3.3 F81803 Super IO Configuration.....	35
4.3.3.1 Serial Port 1 Configuration.....	35
4.3.4 iWDD H/W Monitor.....	36
4.3.5 USB Configuration.....	37
4.3.6 CPU Configuration.....	39
4.3.7 RTC Wake Settings.....	40
4.3.8 Power Saving Configuration.....	42
4.3.9 Serial Port Console Redirection.....	43
4.3.9.1 Console Redirection Settings.....	44
4.3.9.2 Legacy Console Redirection Settings.....	46
4.3.10 IEI Feature.....	47
4.4 CHIPSET.....	48
4.4.1 North Bridge Configuration.....	49
4.4.1.1 Intel IGD Configuration.....	49
4.4.1.2 LCD Control.....	51
4.4.2 South Bridge Configuration.....	52
4.4.2.1 HD-Audio Configuration.....	52
4.4.2.2 PCI Express Configuration.....	53
4.4.2.3 SATA Configuration.....	56
4.5 SECURITY.....	57
4.6 BOOT.....	58
4.7 SAVE & EXIT.....	60

IDS-310AI Embedded System

5 MAINTENANCE	62
5.1 SYSTEM MAINTENANCE OVERVIEW	63
5.2 COMPONENT REPLACEMENT PROCEDURE	63
5.2.1 SO-DIMM Replacement.....	64
6 INTERFACE CONNECTORS	66
6.1 PERIPHERAL INTERFACE CONNECTORS.....	67
6.2 INTERNAL PERIPHERAL CONNECTORS	68
6.2.1 Battery Connector (BT1).....	68
6.2.2 Digital I/O Connector (DIO1).....	69
6.2.3 Firmware Programming Connector for CH7525 (CN1).....	69
6.2.4 M.2 A-key Slot (M2_KEYA1)	69
6.2.5 PCIe Mini Slot (MPCIE1).....	71
6.2.6 SATA Connector (SATA1).....	72
6.2.7 SATA Power Connector (SATA_PWR1).....	72
6.2.8 SMBus Connector (J_SMB2).....	72
6.2.9 SPI Flash Connector, BIOS (J_SPI1)	73
6.2.10 SPI Flash Connector, EC (EC_JP1).....	73
6.3 EXTERNAL INTERFACE PANEL CONNECTORS	73
A REGULATORY COMPLIANCE	74
B SAFETY PRECAUTIONS	79
B.1 SAFETY PRECAUTIONS.....	80
B.1.1 General Safety Precautions.....	80
B.1.2 Anti-static Precautions	81
B.1.3 Product Disposal.....	82
B.2 MAINTENANCE AND CLEANING PRECAUTIONS	83
B.2.1 Maintenance and Cleaning.....	83
B.2.2 Cleaning Tools.....	83
C BIOS MENU OPTIONS	85
C.1 BIOS CONFIGURATION OPTIONS	86
D WATCHDOG TIMER	88
E ERROR BEEP CODE	91

E.1 PEI BEEP CODES.....	92
E.2 DXE BEEP CODES	92
F HAZARDOUS MATERIALS DISCLOSURE.....	93
F.1 ROHS II DIRECTIVE (2015/863/EU)	94
F.2 CHINA ROHS.....	95

List of Figures

Figure 1-1: IDS-310AI Embedded System	2
Figure 1-2: I/O Panel - Front	3
Figure 1-3: I/O Panel - Rear	3
Figure 1-4: Side Panel	4
Figure 1-5: Dimensions with Wall Mount Brackets (mm)	6
Figure 3-1: Bottom Surface Retention Screws	13
Figure 3-2: Bottom Surface Removal	13
Figure 3-3: Knockouts for Wireless Antenna	14
Figure 3-4: Mustang-MPCI-E-MX2 Accelerator Card	14
Figure 3-5: M.2 A-key Slot Location.....	15
Figure 3-6: Inserting the WLAN Module	15
Figure 3-7: Securing the WLAN Module	16
Figure 3-8: Connecting RF Cables.....	16
Figure 3-9: Securing SMA Connector and External Antenna Installation	17
Figure 3-10: AT/ATX Switch Location.....	17
Figure 3-11: Mounting Bracket Retention Screws	18
Figure 3-12: External Peripheral Interface Connectors	19
Figure 3-13: RJ-45 Ethernet Connector.....	20
Figure 3-14: HDMI Connector	22
Figure 3-15: Power Connector	22
Figure 3-16: Power Button and Power LED	25
Figure 3-17: Reset Button Location.....	26
Figure 3-18: Clear CMOS Jumper Location	26
Figure 3-19: Flash Descriptor Security Override Jumper Location	27
Figure 5-1: SO-DIMM Location	64
Figure 5-2: SO-DIMM Installation	65
Figure 6-1: Main Board Layout Diagram	67

List of Tables

Table 1-1: Technical Specifications.....	5
Table 2-1: Package List.....	9
Table 2-2: Optional Items.....	9
Table 3-1: LAN Connector Pinouts.....	20
Table 3-2: Ethernet Connector LEDs.....	20
Table 3-3: HDMI Connector Pinouts.....	21
Table 3-4: Power Connector Pinouts.....	22
Table 3-5: RS-232/422/485 Serial Port Pinouts.....	23
Table 3-6: USB 3.2 Gen 1 Port Pinouts.....	24
Table 3-7: Clear CMOS Jumper Settings.....	26
Table 3-8: Flash Descriptor Security Override Jumper Settings.....	27
Table 4-1: BIOS Navigation Keys.....	30
Table 6-1: Peripheral Interface Connectors.....	68
Table 6-2: Battery Connector (BT1) Pinouts.....	68
Table 6-3: Digital I/O Connector (DIO1) Pinouts.....	69
Table 6-4: Firmware Programming Connector for CH7525 (CN1) Pinouts.....	69
Table 6-5: M.2 A-key Slot (M2_KEYA1) Pinouts.....	70
Table 6-6: PCIe Mini Slot (MPCIE1) Pinouts.....	71
Table 6-7: SATA Connector (SATA1) Pinouts.....	72
Table 6-8: SATA Power Connector (SATA_PWR1) Pinouts.....	72
Table 6-9: SMBus Connector (J_SMB2) Pinouts.....	72
Table 6-10: SPI Flash Connector (J_SPI1) Pinouts.....	73
Table 6-11: SPI Flash Connector (EC_JP1) Pinouts.....	73
Table 6-12: External Interface Panel Connectors.....	73

List of BIOS Menus

BIOS Menu 1: Main	31
BIOS Menu 2: Advanced	32
BIOS Menu 3: Trusted Computing	33
BIOS Menu 4: ACPI Settings	34
BIOS Menu 5: F81803 Super IO Configuration	35
BIOS Menu 6: Serial Port 1 Configuration Menu	35
BIOS Menu 7: iWDD H/W Monitor	36
BIOS Menu 8: USB Configuration	37
BIOS Menu 9: CPU Configuration	39
BIOS Menu 10: RTC Wake Settings	40
BIOS Menu 11: Power Saving Configuration	42
BIOS Menu 12: Serial Port Console Redirection	43
BIOS Menu 13: Console Redirection Settings	44
BIOS Menu 14: Legacy Console Redirection Settings	46
BIOS Menu 15: IEI Feature	47
BIOS Menu 16: Chipset	48
BIOS Menu 17: North Bridge Configuration	49
BIOS Menu 18: Intel IGD Configuration	49
BIOS Menu 19: LCD Control	51
BIOS Menu 20: South Bridge Configuration	52
BIOS Menu 21: HD-Audio Configuration	52
BIOS Menu 22: PCI Express Configuration	53
BIOS Menu 23: M2_KEYA1	54
BIOS Menu 24: MPCIE1	55
BIOS Menu 25: SATA Configuration	56
BIOS Menu 26: Security	57
BIOS Menu 27: Boot	58
BIOS Menu 28: Save & Exit	60

Chapter

1

Introduction

1.1 Overview

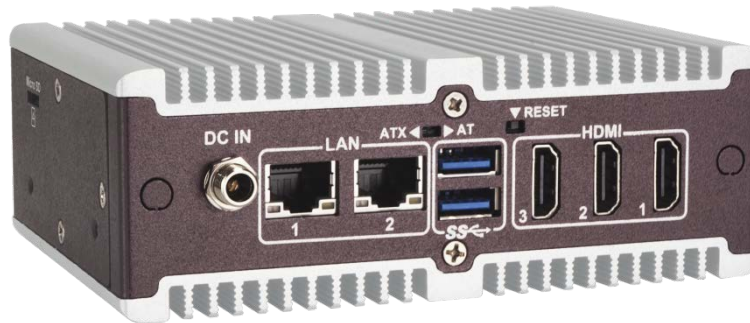

Figure 1-1: IDS-310AI Embedded System

The IDS-310AI is a fanless embedded system with Intel® Celeron® J3455 SoC. The IDS-310AI is preinstalled with 8 GB of DDR3L SO-DIMM. Storage in the system is supported by the pre-installed 128 GB SATA DOM and the microSD slot on the side panel.

The IDS-310AI includes three HDMI outputs supporting up to 3840 x 2160 resolutions. Other slots and connectors include one RS-232/422/485, two GbE ports, three USB 3.2 Gen 1 (5Gb/s) ports, audio (line-out and mic-in) and one M.2 A-key 2230 slot for an optional Wi-Fi module.

1.2 Features

The IDS-310AI has the following features

- Fanless design
- Intel® Celeron® J3455 SoC platform delivers an optimized balance between performance and power consumption
- Three HDMI connectors supporting triple independent display with up to 3840 x 2160 resolution
- Pre-installed with a Mustang-MPCIE-MX2 accelerator card for AI inference applications

IDS-310AI Embedded System

- Pre-installed with 128 GB SATA DOM
- Two GbE LAN for high speed network applications
- Three USB 3.2 Gen 1 (5Gb/s) ports
- One RS-232/422/485 serial port
- Support audio line-out and mic-in
- RoHS compliant design

1.3 I/O Panels

The I/O panels of the IDS-310AI are shown in **Figure 1-2** and **Figure 1-3**.

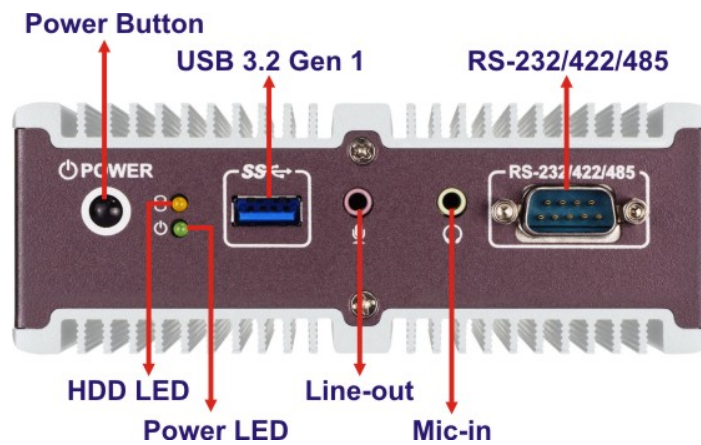

Figure 1-2: I/O Panel - Front

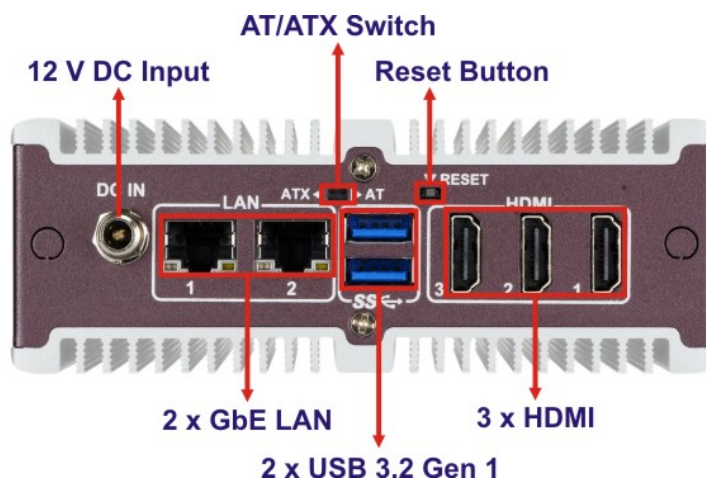

Figure 1-3: I/O Panel - Rear

1.4 Side Panel

The side panel of the IDS-310AI has one microSD slot.



Figure 1-4: Side Panel

1.5 Technical Specifications

The specifications for the IDS-310AI are listed below.

	IDS-310AI
CPU	Intel® Celeron® J3455 (up to 2.3 GHz, quad-core, TDP 10 W)
System Memory	1 x 204-pin DDR3L SDRAM SO-DIMM slot (system max. 8 GB) 8 GB DDR3L SO-DIMM pre-installed
Display	3 x HDMI 1.4b connector (up to 3840x2160 @ 30Hz) (HDMI 3 does not support audio)
Ethernet	2 x GbE LAN RJ-45 by Realtek RTL8111H GbE controller
Serial Port	1 x RS-232/422/485 DB-9 serial port
USB	3 x USB 3.2 Gen 1 (5Gb/s) port
Audio	7.1+2 channel Realtek ALC888 HD Audio codec 1 x Line-out jack 1 x Mic-in jack
Storage	128 GB SATA DOM pre-installed 1 x microSD slot (on side panel)

IDS-310AI Embedded System

Accelerator	Mustang-MPCI-E-MX2 VPU accelerator card pre-installed	
Expansion Slot	1 x M.2 A-key 2230 slot (PCIe x1, USB 2.0) for optional Wi-Fi module	
Wireless	Optional Wi-Fi 802.11a/b/g/n/ac	
Buttons and Indicators	1 x Power button 1 x Reset button 1 x AT/ATX power mode switch	1 x Power LED (green) 1 x HDD LED (yellow)
Mounting	Wall mount	
Power Input	12 V DC	
Power Consumption	12V @ 2.6A (Intel® Celeron® J3455 with 8GB memory)	
Operating Temperature	-20°C ~ +45°C	
Storage Temperature	-30°C ~ +80°C	
Operating Humidity	10% ~ 90%, non-condensing	
Watchdog Timer	Programmable 1~255 sec/min	
Color	Brown & Silver	
Chassis Construction	Extruded aluminum alloys	
Dimensions (W x D x H)	137 mm x 102.8 mm x 49.2 mm	
Operation Vibration	MIL-STD-810F 514.6C-1	
Operation Shock	Half-sine wave shock 5G, 11ms, 100 shocks per axis	
Weight (Net/Gross)	910 g / 1.7 kg	
EMC	CE, FCC Class A	
Supported OS	Microsoft Windows 10 Linux	

Table 1-1: Technical Specifications

1.6 Dimensions

The physical dimensions of the IDS-310AI with its mounting kit are shown below.

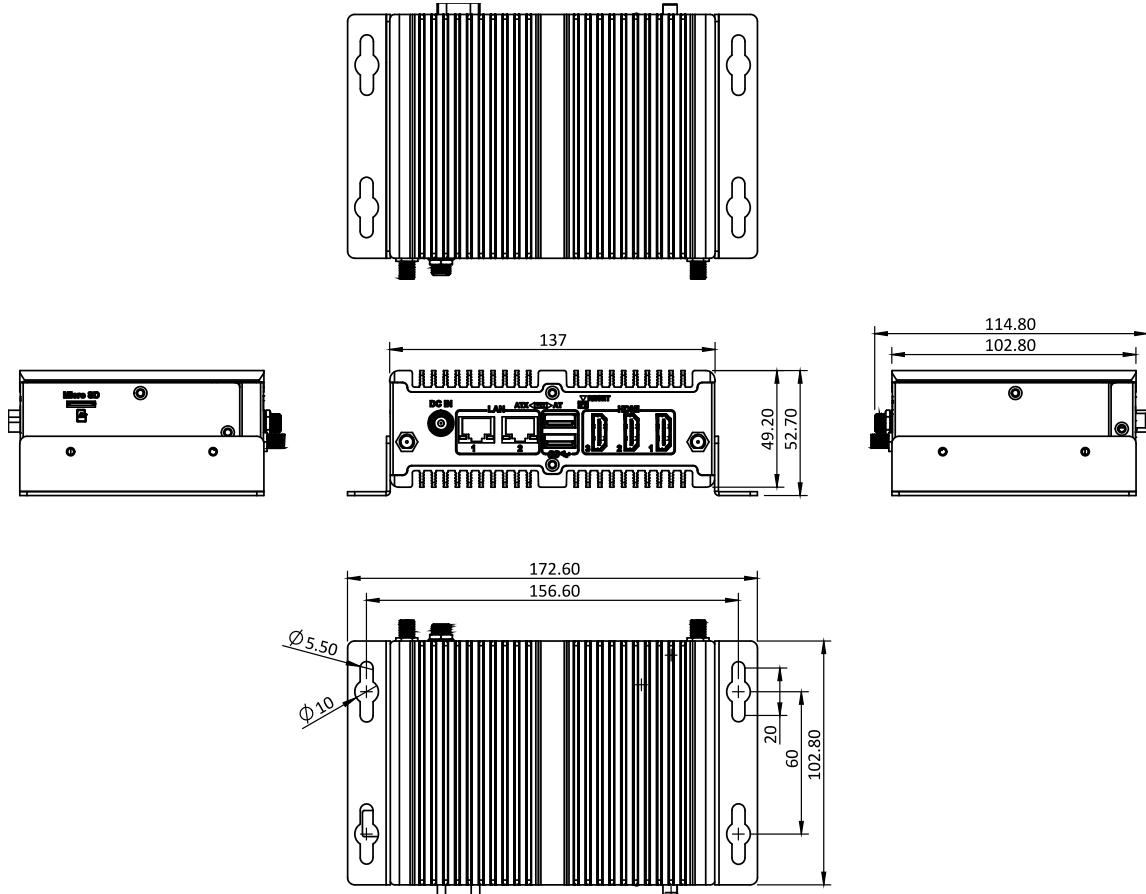

Figure 1-5: Dimensions with Wall Mount Brackets (mm)

Chapter

2

Unpacking

2.1 Unpacking

To unpack the system, follow the steps below:

- Step 1:** Use box cutters, a knife or a sharp pair of scissors that seals the top side of the external (second) box.
- Step 2:** Open the external (second) box.
- Step 3:** Use box cutters, a knife or a sharp pair of scissors that seals the top side of the internal (first) box.
- Step 4:** Lift the system out of the boxes.
- Step 5:** Remove both polystyrene ends, one from each side.
- Step 6:** Make sure all the components listed in the packing list are present.

2.2 Packing List



NOTE:

If any of the components listed in the checklist below are missing, do not proceed with the installation. Contact the IEI reseller or vendor the IDS-310AI was purchased from or contact an IEI sales representative directly by sending an email to sales@ieiworld.com.

The IDS-310AI is shipped with the following components:

Quantity	Item	Image
1	IDS-310AI embedded system	

IDS-310AI Embedded System

1	Power adapter (36 W)	
1	Power cord	
2	Wall mount bracket	
4	Screws (M3*5) for wall mount	

Table 2-1: Package List

2.3 Optional Items

The following are optional component(s) which may be separately purchased:

Wi-Fi module* (P/N: 27319-000009-RS)	
External antenna (P/N: 32505-000900-100-RS)	
RF cable, 250mm (P/N: 32501-004000-100-RS)	

**Each Wi-Fi module needs two external antennas and two RF cables to fully support Wi-Fi function.*

Table 2-2: Optional Items

Chapter

3

Installation

IDS-310AI Embedded System

3.1 Anti-static Precautions



WARNING:

Failure to take ESD precautions during installation may result in permanent damage to the IDS-310AI and severe injury to the user.

Electrostatic discharge (ESD) can cause serious damage to electronic components, including the IDS-310AI. Dry climates are especially susceptible to ESD. It is therefore critical that whenever the IDS-310AI or any other electrical component is handled, the following anti-static precautions are strictly adhered to.

- **Wear an anti-static wristband:** Wearing a simple anti-static wristband can help to prevent ESD from damaging the board.
- **Self-grounding:** Before handling the board, touch any grounded conducting material. During the time the board is handled, frequently touch any conducting materials that are connected to the ground.
- **Use an anti-static pad:** When configuring the IDS-310AI, place it on an anti-static pad. This reduces the possibility of ESD damaging the IDS-310AI.

3.2 Installation Precautions

During installation, be aware of the precautions below:

- **Read the user manual:** The user manual provides a complete description of the IDS-310AI, installation instructions and configuration options.
- **DANGER! Disconnect Power:** Power to the IDS-310AI must be disconnected during the installation process, or before any attempt is made to access the bottom panel. Electric shock and personal injury might occur if the bottom panel of the IDS-310AI is opened while the power cord is still connected to an electrical outlet.
- **Qualified Personnel:** The IDS-310AI must be installed and operated only by trained and qualified personnel. Maintenance, upgrades, or repairs may only be carried out by qualified personnel who are familiar with the associated dangers.

- **Air Circulation:** Make sure there is sufficient air circulation when installing the IDS-310AI. The IDS-310AI must not be obstructed by any objects. Leave at least 5 cm of clearance around the IDS-310AI to prevent overheating.
- **Grounding:** The IDS-310AI should be properly grounded. The voltage feeds must not be overloaded. Adjust the cabling and provide external overcharge protection per the electrical values indicated on the label attached to the back of the IDS-310AI.

3.2.1 High Surface Temperature



WARNING:

Some surfaces of the equipment may become hot during operation.

The surface temperature may be up to several tens of degrees hotter than the ambient temperature. Under these circumstances, the equipment needs to be protected against accidental contact.

The equipment is intended for installation in a RESTRICTED ACCESS LOCATION.

- Access can only be gained by SERVICE PERSONS or by USERS who have been instructed about the reasons for the restrictions applied to the location and about any precautions that shall be taken.
- Access is through the use of a TOOL or lock and key, or other means of security, and is controlled by the authority responsible for the location.

3.3 Bottom Surface Removal

Before internal devices can be installed, the bottom surface must be removed. To remove the bottom surface, please follow the steps below:

- Step 1:** Remove the bottom surface retention screws. The bottom surface is secured to the chassis with four (4) retention screws (**Figure 3-1**). All four (4) screws must be removed.

IDS-310AI Embedded System



Figure 3-1: Bottom Surface Retention Screws

Step 2: Gently lift and remove the bottom surface from the IDS-310AI.



Figure 3-2: Bottom Surface Removal

3.4 Wireless LAN Module Installation (Optional)

To install the optional wireless LAN (WLAN) module, please follow the steps below.

- Step 1:** Remove the bottom surface. See **Section 3.3**.
- Step 2:** Remove the two knockouts for antenna installation. The two knockouts are located on the rear panel of the IDS-310AI as shown in **Figure 3-3**.

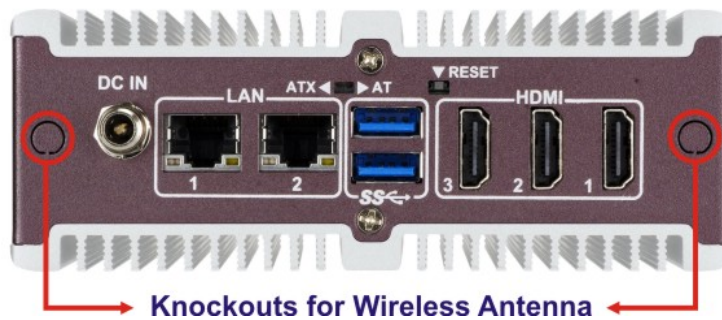

Figure 3-3: Knockouts for Wireless Antenna

- Step 3:** Remove the pre-installed Mustang-MPCIE-MX2 accelerator card to access the M.2 slot. To remove the card, remove the retention screw indicated in **Figure 3-4** and gently pull the card out from the slot.

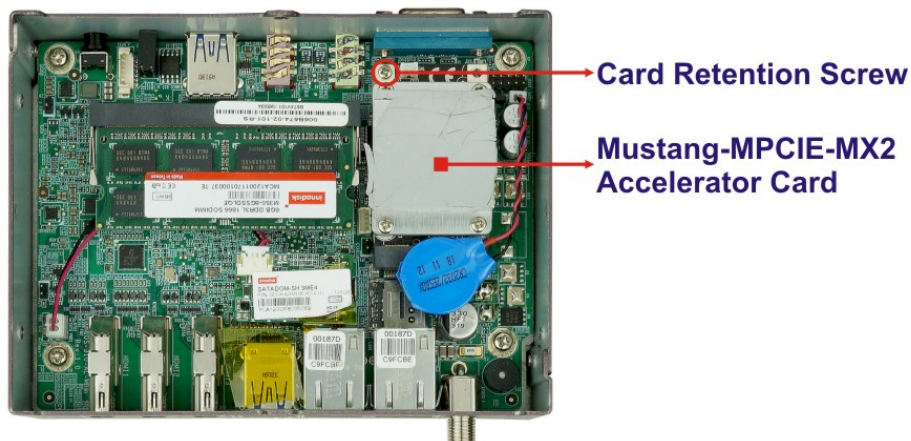

Figure 3-4: Mustang-MPCIE-MX2 Accelerator Card

IDS-310AI Embedded System

- Step 4:** Locate the M.2 A-key slot on the motherboard (Figure 3-5). Remove the M.2 module screw.

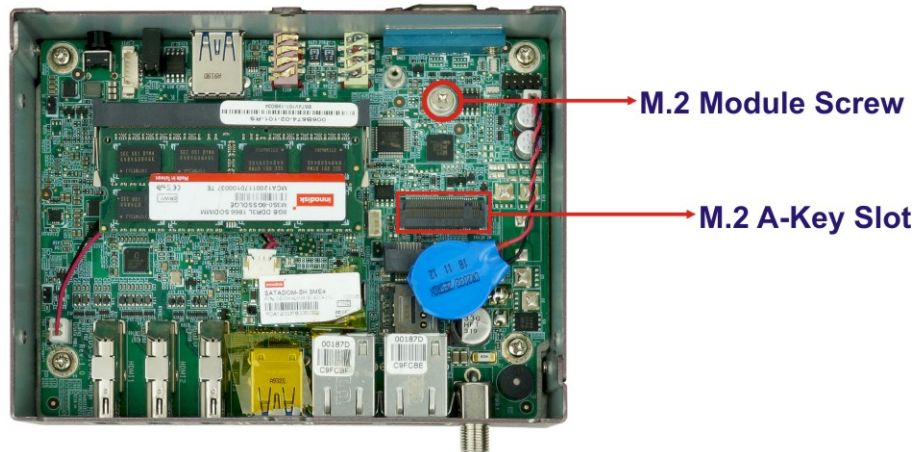

Figure 3-5: M.2 A-key Slot Location

- Step 5:** Line up the notch on the WLAN module with the notch on the slot. Slide the WLAN module into the slot at an angle of about 20° (Figure 3-6).

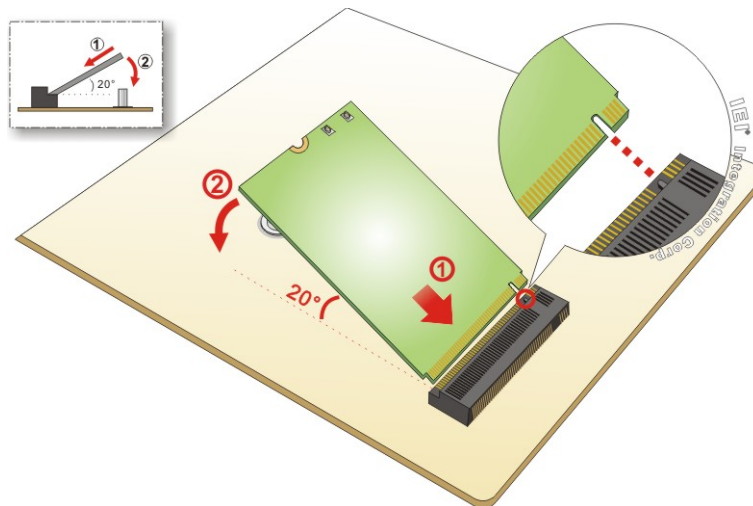

Figure 3-6: Inserting the WLAN Module

- Step 6:** Secure the WLAN module with the retention screw previously removed (Figure 3-8).

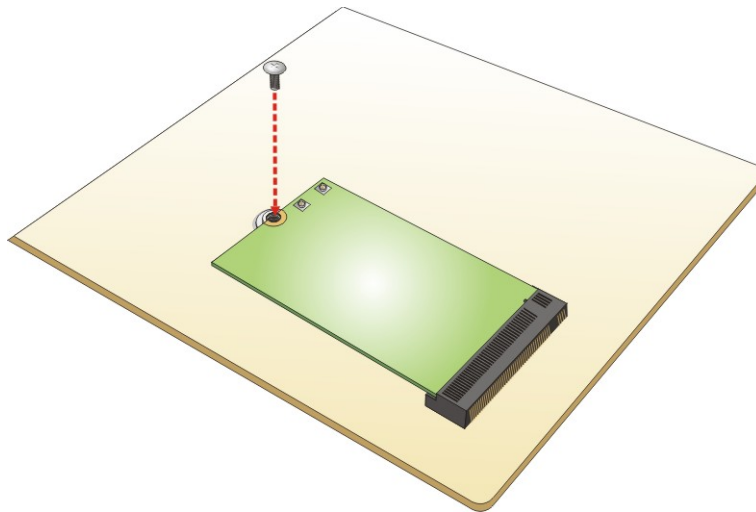

Figure 3-7: Securing the WLAN Module

Step 7: Connect the two RF cables to the antenna connectors on the WLAN module (Figure 3-8).

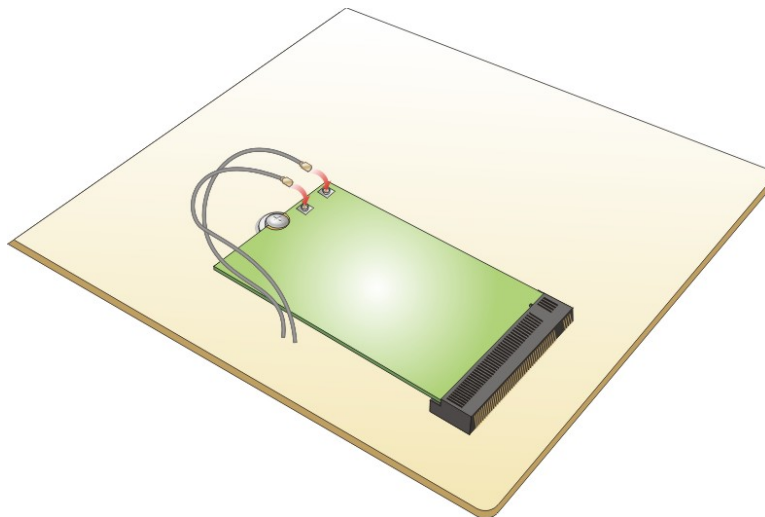

Figure 3-8: Connecting RF Cables

Step 8: Remove the nut and washer from the SMA connector at the other end of the RF cable.

Step 9: Insert the SMA connector to the antenna connector holes on the rear panel.

Step 10: Secure the SMA connector by inserting the washer and tightening it with nut.

IDS-310AI Embedded System

Step 11: Install the external antenna.

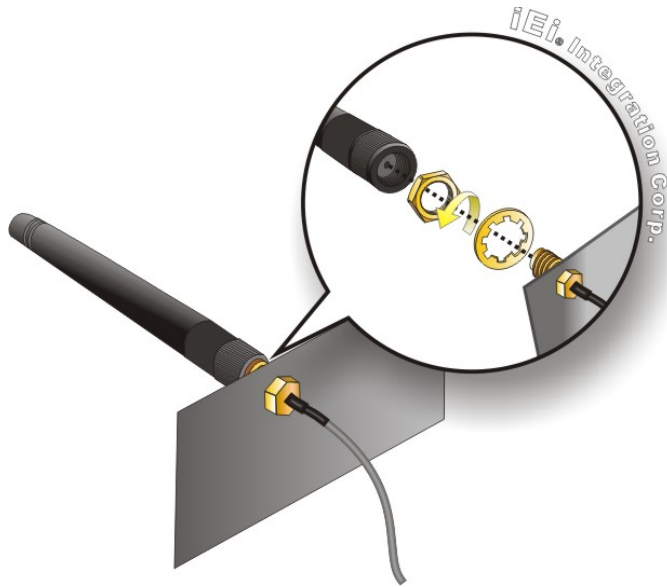

Figure 3-9: Securing SMA Connector and External Antenna Installation

3.5 AT/ATX Power Mode Selection

AT and ATX power modes can both be used on the IDS-310AI. The selection is made through an AT/ATX switch on the rear panel (Figure 1-3).

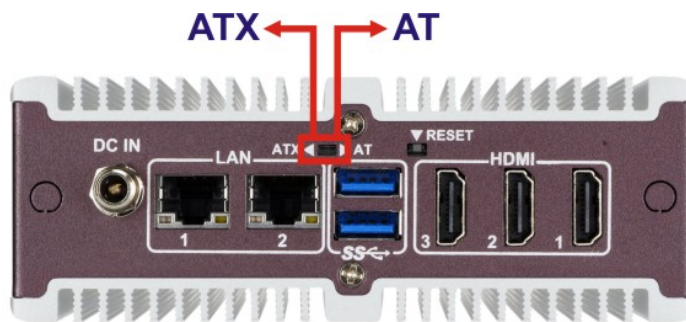

Figure 3-10: AT/ATX Switch Location

3.6 Mounting the System

To mount the IDS-310AI onto a wall or some other surface using the two mounting brackets, please follow the steps below.

- Step 1:** Align the two retention screw holes in each bracket with the retention screw holes on the side panels.
- Step 2:** Secure the brackets to the system by inserting two retention screws (M3*5) into each bracket (**Figure 3-11**).

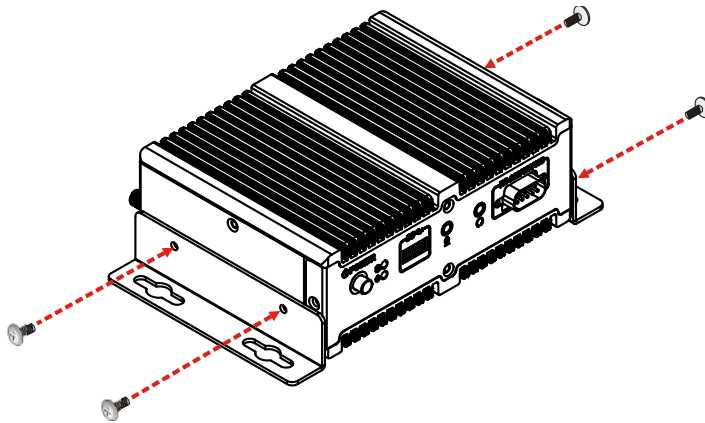

Figure 3-11: Mounting Bracket Retention Screws

- Step 3:** Drill holes in the intended installation surface according to the bracket dimensions shown in **Figure 1-5** in Chapter 1.
- Step 4:** Align the mounting holes in the sides of the mounting brackets with the predrilled holes in the mounting surface.
- Step 5:** Insert retention screws into each bracket to secure the system to the wall.

IDS-310AI Embedded System

3.7 External Peripheral Interface Connection

The following external peripheral devices can be connected to the external peripheral interface connectors.

- Audio devices
- RJ-45 Ethernet cable connectors
- HDMI monitors
- Serial port devices
- USB devices

The locations of the external peripheral interface connectors are shown in **Figure 3-12**.

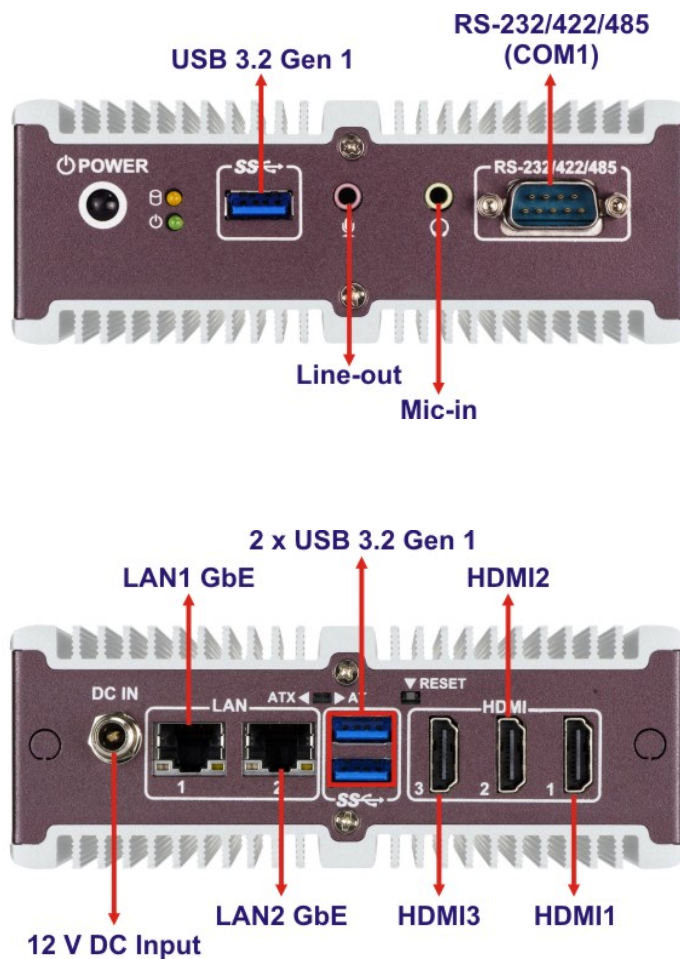

Figure 3-12: External Peripheral Interface Connectors

3.7.1 LAN Connectors

- CN Label:** LAN1, LAN2
- CN Type:** RJ-45
- CN Pinouts:** See **Table 3-1**
- CN Location:** See **Figure 3-12**

The LAN connector allows connection to an external network.

Pin	Description	Pin	Description
1	MDIA0+	5	MDIA2-
2	MDIA0-	6	MDIA1-
3	MDIA1+	7	MDIA3+
4	MDIA2+	8	MDIA3-

Table 3-1: LAN Connector Pinouts

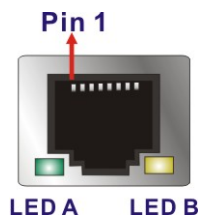

Figure 3-13: RJ-45 Ethernet Connector

The RJ-45 Ethernet connector has two status LEDs, one green and one yellow. The green LED indicates activity on the port and the yellow LED indicates the port is linked. See **Table 3-2**.

LED	Description	LED	Description
A	off: 10 Mb/s green: 100 Mb/s orange: 1000 Mb/s	B	on: linked blinking: data is being sent/received

Table 3-2: Ethernet Connector LEDs

IDS-310AI Embedded System

3.7.2 HDMI Connectors

**NOTE:**

1. Due to chipset limitation, audio is not supported over the HDMI3 connector.
2. Fully support of triple 4K display output may vary in different system environment setting. In some conditions, the IDS-310AI may only support two 4K outputs plus one Full HD output via the three HDMI connectors. To setup a triple 4K display connection in Windows, make sure the following graphics driver version is installed in the system: Intel® Graphics Driver - 64 Bit (22.20.16.4785).

CN Label:	HDMI1, HDMI2, HDMI3
CN Type:	HDMI connector
CN Pinouts:	See Table 3-3 and Figure 3-14
CN Location:	See Figure 3-12

The HDMI connector can connect to an HDMI device. The HDMI connectors support up to 3840x2160 @ 30Hz.

Pin	Description	Pin	Description
1	HDMI_DATA2+	11	GND
2	GND	12	HDMI_CLK#
3	HDMI_DATA2#-	13	N/C
4	HDMI_DATA1+	14	N/C
5	GND	15	HDMI_SCL
6	HDMI_DATA1#-	16	HDMI_SDA
7	HDMI_DATA0+	17	GND
8	GND	18	+5V
9	HDMI_DATA0#-	19	HDMI_HPD
10	HDMI_CLK+		

Table 3-3: HDMI Connector Pinouts

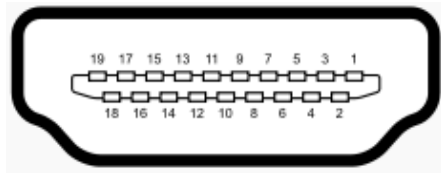

Figure 3-14: HDMI Connector

3.7.3 Power Connector

- CN Label:** PWR1
- CN Type:** DC jack
- CN Pinouts:** See **Table 3-4**
- CN Location:** See **Figure 3-12**

The connector supports 12 V power adapters.

Pin	Description
1	12V
2	GND
3	GND

Table 3-4: Power Connector Pinouts



Figure 3-15: Power Connector

IDS-310AI Embedded System

3.7.4 RS-232/422/485 Serial Port Connector

- CN Label:** COM1
- CN Type:** DB-9 male
- CN Pinouts:** See Table 3-5
- CN Location:** See Figure 3-12

The RS-232/422/485 serial port connector allows connection to a serial device. The serial communication mode selection can be made through the BIOS options. Please refer to **Section 4.3.3.1** for detail information. The pinouts of COM1 are detailed below.

Pin	RS-232	RS-422	RS-485
1	DCD	TXD422-	TXD485-
2	RX	TXD422+	TXD485+
3	TX	RXD422+	
4	DTR	RXD422-	
5	GND		
6	DSR		
7	RTS		
8	CTS		
9	RI		



The diagram shows a DB-9 male serial port connector. Pin 1 is the top-left pin, and pin 6 is the bottom-left pin. Red arrows point from the numbers 1 and 6 to their respective pins.

Table 3-5: RS-232/422/485 Serial Port Pinouts

3.7.5 USB 3.2 Gen 1 (5Gb/s) Connectors

CN Label: USB3-1, USB3-2

CN Type: USB Type A

CN Pinouts: See Table 3-6

CN Location: See Figure 3-12

The USB 3.2 Gen 1 (5Gb/s) ports are for connecting USB 2.0 / USB 3.2 Gen 1 peripheral devices to the system.

Pin	Description
1	VBUS
2	DATA-
3	DATA+
4	GND
5	STDA_SSRX_N
6	STDA_SSRX_P
7	GND_DRAIN
8	STDA_SSTX_N
9	STDA_SSTX_P

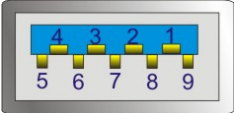

Table 3-6: USB 3.2 Gen 1 Port Pinouts

IDS-310AI Embedded System

3.8 Power-On Procedure

3.8.1 Installation Checklist



WARNING:

Make sure a power supply with the correct input voltage is being fed into the system. Incorrect voltages applied to the system may cause damage to the internal electronic components and may also cause injury to the user.

To power on the IDS-310AI please make sure of the following:

- The bottom surface panel is installed
- All peripheral devices (monitor, serial communications devices etc.) are connected
- The power cables are plugged in
- The system is securely mounted

3.8.2 Power-on Procedure

To power-on the IDS-310AI, please follow the steps below.

Step 1: Connect the power source to the power input jack.

Step 2: Push the power button (**Figure 3-16**).

Step 3: Once turned on, the power LED indicator should turn on in green.

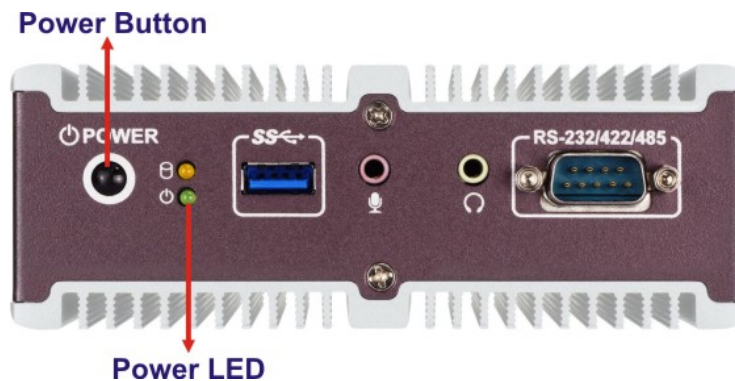

Figure 3-16: Power Button and Power LED

3.9 Reset the System

The reset button enables user to reboot the system when the system is turned on. The reset button location is shown in **Figure 3-17**. Press the reset button to reboot the system.

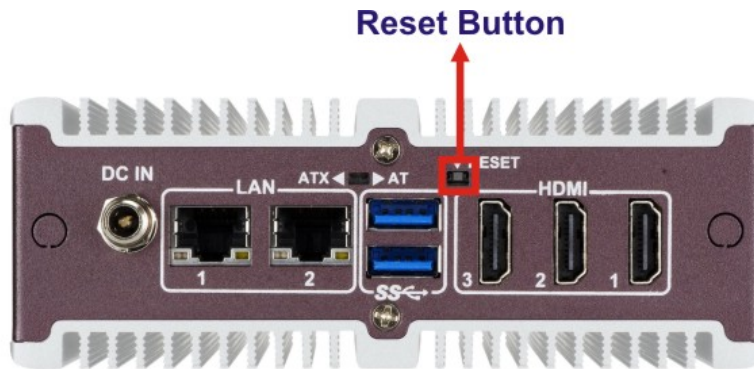

Figure 3-17: Reset Button Location

3.10 Clear CMOS

To reset the BIOS, move the jumper to the "Clear BIOS" position for 3 seconds or more, then move back to the default position.

Setting	Description
Short 1-2	Keep CMOS setup
Short 2-3	Clear CMOS

Table 3-7: Clear CMOS Jumper Settings

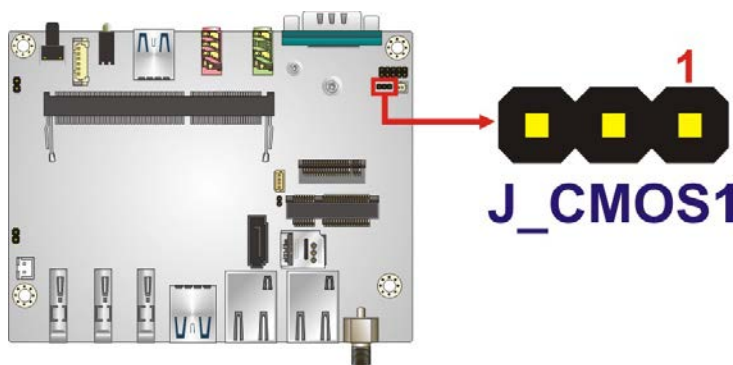

Figure 3-18: Clear CMOS Jumper Location

IDS-310AI Embedded System

3.11 Flash Descriptor Security Override

The Flash Descriptor Security Override jumper (J_TXE1) allows to enable or disable the ME firmware update. Refer to **Figure 3-19** and **Table 3-8** for the jumper location and settings.

Setting	Description
Open	Disabled (default)
Short	Enabled

Table 3-8: Flash Descriptor Security Override Jumper Settings

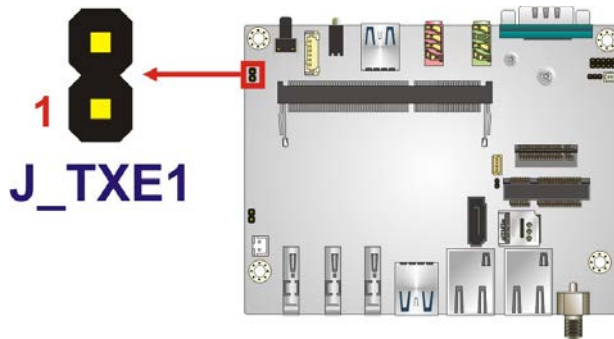

Figure 3-19: Flash Descriptor Security Override Jumper Location

To update the ME firmware, please follow the steps below.

- Step 1:** Before turning on the system power, short the Flash Descriptor Security Override jumper.
- Step 2:** Update the BIOS and ME firmware, and then turn off the system power.
- Step 3:** Remove the metal clip on the Flash Descriptor Security Override jumper.
- Step 4:** Restart the system. The system will reboot 2 ~ 3 times to complete the ME firmware update.

Chapter

4

BIOS

IDS-310AI Embedded System

4.1 Introduction

The BIOS is programmed onto the BIOS chip. The BIOS setup program allows changes to certain system settings. This chapter outlines the options that can be changed.

4.1.1 Starting Setup

The UEFI BIOS is activated when the computer is turned on. The setup program can be activated in one of two ways.

1. Press the **DEL** or **F2** key as soon as the system is turned on or
2. Press the **DEL** or **F2** key when the “**Press DEL or F2 to enter SETUP**” message appears on the screen.

If the message disappears before the **DEL** or **F2** key is pressed, restart the computer and try again.

4.1.2 Using Setup

Use the arrow keys to highlight items, press **ENTER** to select, use the PageUp and PageDown keys to change entries, press **F1** for help and press **ESC** to quit. Navigation keys are shown in.

Key	Function
Up arrow	Move to previous item
Down arrow	Move to next item
Left arrow	Move to the item on the left hand side
Right arrow	Move to the item on the right hand side
+	Increase the numeric value or make changes
-	Decrease the numeric value or make changes
Esc key	Main Menu – Quit and not save changes into CMOS Status Page Setup Menu and Option Page Setup Menu -- Exit current page and return to Main Menu
F1	General help, only for Status Page Setup Menu and Option Page Setup Menu

Key	Function
F2	Previous values
F3	Load optimized defaults
F4	Save changes and Exit BIOS

Table 4-1: BIOS Navigation Keys

4.1.3 Getting Help

When **F1** is pressed a small help window describing the appropriate keys to use and the possible selections for the highlighted item appears. To exit the Help Window press **Esc** or the **F1** key again.

4.1.4 BIOS Menu Bar

The **menu bar** on top of the BIOS screen has the following main items:

- Main – Changes the basic system configuration.
- Advanced – Changes the advanced system settings.
- Chipset – Changes the chipset settings.
- Boot – Changes the system boot configuration.
- Security – Sets User and Supervisor Passwords.
- Save & Exit – Selects exit options and loads default settings

The following sections completely describe the configuration options found in the menu items at the top of the BIOS screen and listed above.

IDS-310AI Embedded System

4.2 Main

The **Main** BIOS menu (**BIOS Menu 1**) appears when the **BIOS Setup** program is entered.

The **Main** menu gives an overview of the basic system information.

```

Aptio Setup Utility - Copyright (C) 2020 American Megatrends, Inc.
Main  Advanced  Chipset  Security  Boot  Save & Exit

BIOS Information
BIOS Vendor                American Megatrends
Core Version               5.12
Compliance                 UEFI 2.5; PI 1.4
Project Version            Z675AR11.ROM
Build Date and Time        08/28/2020 17:50:14

iWDD Vendor                iEi
iWDD Version               Z632ER10.bin

Platform firmware Information
BXT SOC                    F1
MRC Version                 0.56
PUNIT FW                   1A
PMC FW                     03.20
TXE FW                     3.1.70.2325
GOP                        0.0.0036

Memory Information
Total Memory                8192 MB
Memory Speed                1866 MHz

Access Level                Administrator

System Date                 [Fri 09/24/2010]
System Time                 [14:10:17]

Set the Date. Use Tab to
switch between Data
elements.

-----
<->: Select Screen
^ v: Select Item
Enter>Select
+ -  Change Opt.
F1   General Help
F2   Previous Values
F3   Optimized Defaults
F4   Save & Exit
ESC  Exit

Version 2.18.1263. Copyright (C) 2020 American Megatrends, Inc.
  
```

BIOS Menu 1: Main

➔ System Date [xx/xx/xx]

Use the **System Date** option to set the system date. Manually enter the day, month and year.

➔ System Time [xx:xx:xx]

Use the **System Time** option to set the system time. Manually enter the hours, minutes and seconds.

4.3 Advanced

Use the **Advanced** menu (**BIOS Menu 2**) to configure the CPU and peripheral devices through the following sub-menus:



WARNING!

Setting the wrong values in the sections below may cause the system to malfunction. Make sure that the settings made are compatible with the hardware.

```

Aptio Setup Utility - Copyright (C) 2020 American Megatrends, Inc.
Main  Advanced  Chipset  Security  Boot  Save & Exit

> Trusted Computing
> ACPI Settings
> F81803 Super IO Configuration
> iWDD H/M Monitor
> USB Configuration
> CPU Configuration
> RTC Wake Settings
> Power Saving Configuration
> Serial Port Console Redirection
> iEi Feature

System ACPI Parameters.

-----
<->: Select Screen
↑ ↓: Select Item
Enter>Select
F1  General Help
F2  Previous Values
F3  Optimized Defaults
F4  Save
ESC Exit

Version 2.18.1263. Copyright (C) 2020 American Megatrends, Inc.
    
```

BIOS Menu 2: Advanced

4.3.1 Trusted Computing

Use the **Trusted Computing** menu (**BIOS Menu 3**) to configure settings related to the Trusted Computing Group (TCG) Trusted Platform Module (TPM).

IDS-310AI Embedded System

```

Aptio Setup Utility - Copyright (C) 2020 American Megatrends, Inc.
  Advanced
TPM20 Device Found
Firmware Version:      5.63
Vendor:                IFX

Security Device Support  [Enable]
TPM State               [Enable]
Pending operation       [None]

-----

<=>: Select Screen
↑ ↓: Select Item
Enter>Select
F1   General Help
F2   Previous Values
F3   Optimized
Defaults
F4   Save
ESC  Exit

Version 2.18.1263. Copyright (C) 2020 American Megatrends, Inc.
  
```

BIOS Menu 3: Trusted Computing

→ Security Device Support [Enable]

Use the **Security Device Support** option to configure support for the security device.

- **Disable** Security device support is disabled.
- **Enable** **DEFAULT** Security device support is enabled.

→ TPM State [Enabled]

Use the **TPM State** option to enable or disable the TPM device.

- **Disabled** TPM device is disabled.
- **Enabled** **DEFAULT** TPM device is enabled.

→ Pending Operation [None]

Use the **Pending Operation** option to specify a TPM operation which will be performed during the next boot process.

- ➔ **None** **DEFAULT** No TPM operation will be performed.
- ➔ **TPM Clear** TPM is reset to the factory setting. All data in the TPM will be deleted.

4.3.2 ACPI Settings

The **ACPI Settings** menu (**BIOS Menu 4**) configures the Advanced Configuration and Power Interface (ACPI) options.

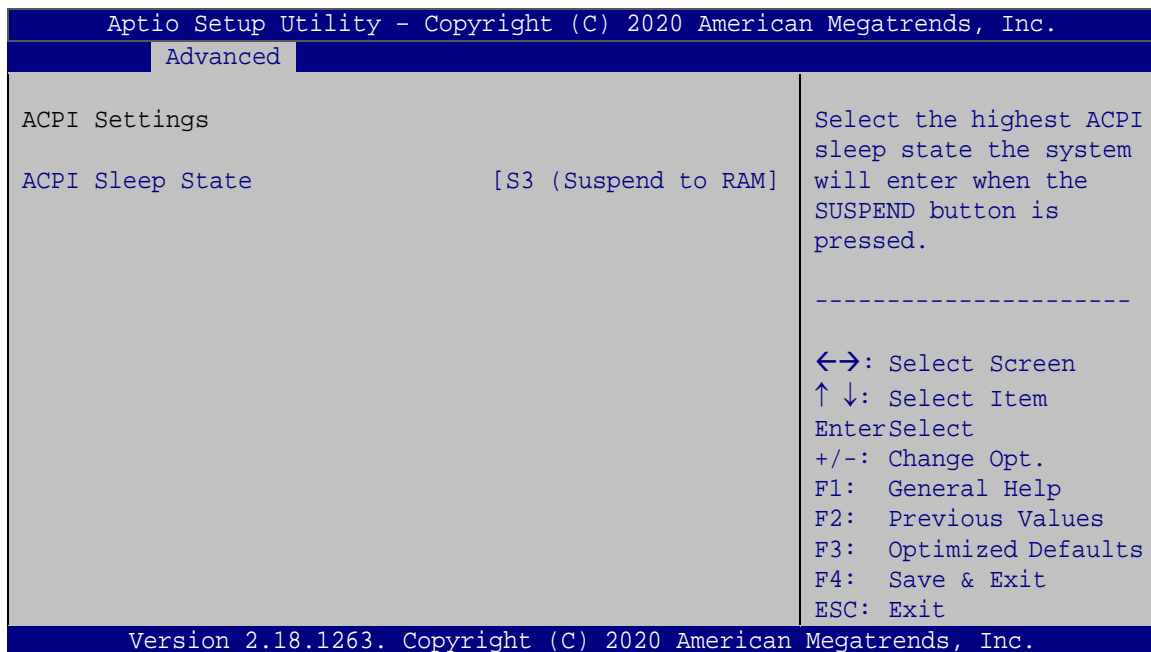

BIOS Menu 4: ACPI Settings

➔ **ACPI Sleep State [S3 (Suspend to RAM)]**

Use the **ACPI Sleep State** option to specify the sleep state the system enters when it is not being used.

- ➔ **S3 (Suspend to RAM)** **DEFAULT** The caches are flushed and the CPU is powered off. Power to the RAM is maintained. The computer returns slower to a working state, but more power is saved.

IDS-310AI Embedded System

4.3.3 F81803 Super IO Configuration

Use the **F81803 Super IO Configuration** menu (**BIOS Menu 5**) to set or change the configurations for the serial ports.

```

Aptio Setup Utility - Copyright (C) 2020 American Megatrends, Inc.
  Advanced
F81866 Super IO Configuration                               Set Parameters of Serial
                                                           Port 1 (COMA)
Super IO Chip                                             F81803
> Serial Port 1 Configuration
-----
<->: Select Screen
↑ ↓: Select Item
EnterSelect
+/-: Change Opt.
F1:  General Help
F2:  Previous Values
F3:  Optimized Defaults
F4:  Save & Exit
ESC: Exit
Version 2.18.1263. Copyright (C) 2020 American Megatrends, Inc.
    
```

BIOS Menu 5: F81803 Super IO Configuration

4.3.3.1 Serial Port 1 Configuration

Use the **Serial Port 1 Configuration** menu (**BIOS Menu 6**) to configure the serial port 1.

```

Aptio Setup Utility - Copyright (C) 2020 American Megatrends, Inc.
  Advanced
Serial Port 1 Configuration                               Enable or Disable Serial
                                                           Port (COM)
Serial Port                                             [Enabled]
Device Settings                                       IO=3F8h; IRQ=4
Transfer Mode                                           [RS232]
-----
<->: Select Screen
↑ ↓: Select Item
EnterSelect
+/-: Change Opt.
F1:  General Help
F2:  Previous Values
F3:  Optimized Defaults
F4:  Save & Exit
ESC: Exit
Version 2.18.1263. Copyright (C) 2020 American Megatrends, Inc.
    
```

BIOS Menu 6: Serial Port 1 Configuration Menu

➔ **Serial Port [Enabled]**

Use the **Serial Port** option to enable or disable the serial port.

- ➔ **Disabled** Disable the serial port
- ➔ **Enabled** **DEFAULT** Enable the serial port

➔ **Transfer Mode [RS232]**

Use the **Transfer Mode** option to select the Serial Port 1 signaling mode.

- ➔ **RS422** Serial Port 1 signaling mode is RS-422
- ➔ **RS232** **DEFAULT** Serial Port 1 signaling mode is RS-232
- ➔ **RS485** Serial Port 1 signaling mode is RS-485

4.3.4 iWDD H/W Monitor

The **iWDD H/W Monitor** menu (**BIOS Menu 7**) displays operating temperature and system voltages.

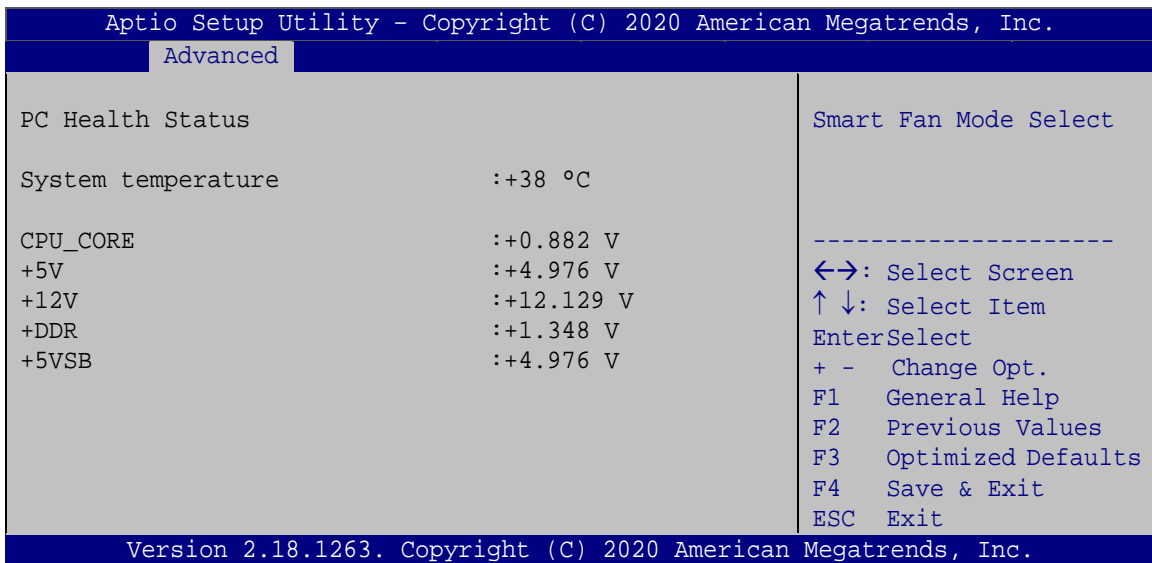

BIOS Menu 7: iWDD H/W Monitor

IDS-310AI Embedded System

→ PC Health Status

The following system parameters and values are shown. The system parameters that are monitored are:

- System Temperature
- Voltages
 - CPU_CORE
 - +5V
 - +12V
 - +DDR
 - +5VSB

4.3.5 USB Configuration

Use the **USB Configuration** menu (**BIOS Menu 8**) to read USB configuration information and configure the USB settings.

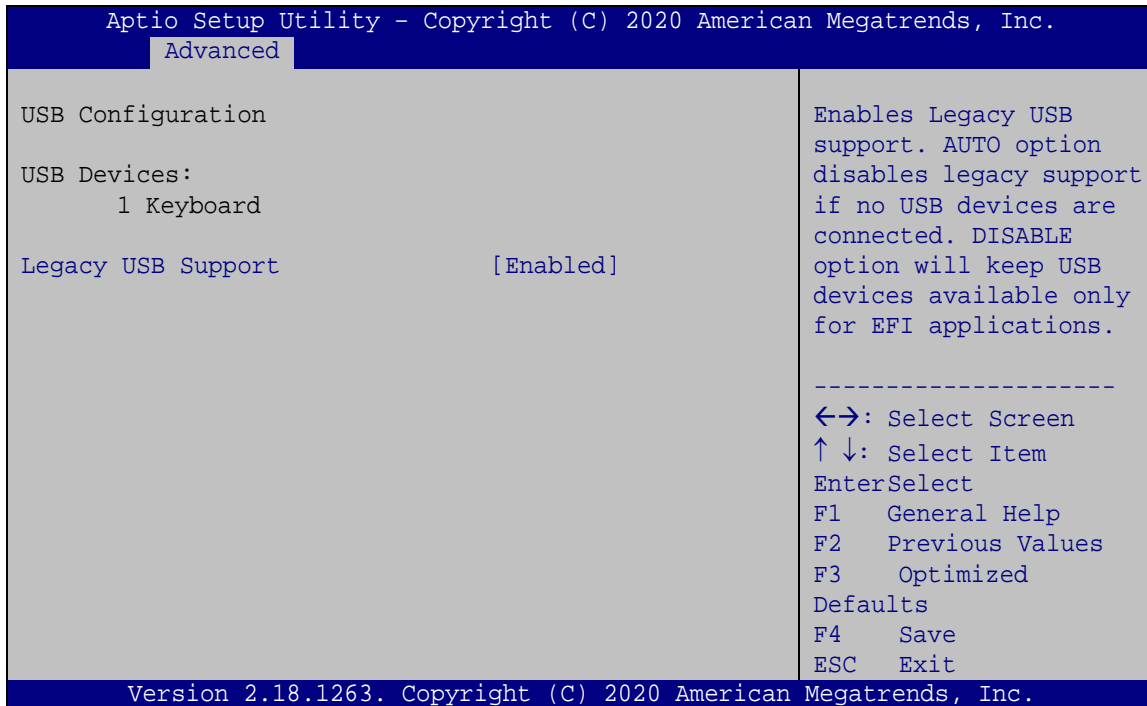

BIOS Menu 8: USB Configuration

→ **USB Devices**

The **USB Devices** field lists the USB devices that are enabled on the system

→ **Legacy USB Support [Enabled]**

Use the **Legacy USB Support** BIOS option to enable USB mouse and USB keyboard support. Normally if this option is not enabled, any attached USB mouse or USB keyboard does not become available until a USB compatible operating system is fully booted with all USB drivers loaded. When this option is enabled, any attached USB mouse or USB keyboard can control the system even when there is no USB driver loaded onto the system.

- | | | |
|-------------------|----------------|---|
| → Enabled | DEFAULT | Legacy USB support enabled |
| → Disabled | | Legacy USB support disabled |
| → Auto | | Legacy USB support disabled if no USB devices are connected |

IDS-310AI Embedded System

4.3.6 CPU Configuration

Use the **CPU Configuration** menu (**BIOS Menu 9**) to view detailed CPU specifications and configure the CPU.

```

Aprio Setup Utility - Copyright (C) 2020 American Megatrends, Inc.
  Advanced
CPU Configuration
Intel(R) Celeron(R) CPU J3455 @ 1.50GHz
CPU Signature          506CA
Microcode Patch       1A
Max CPU Speed         1500 MHz
Min CPU Speed         800 MHz
Processor Cores       4
Intel HT Technology   Not Supported
Intel VT-x Technology Supported
L1 Data Cache        24 KB x 4
L1 Code Cache        32 KB x 4
L2 Cache             1024 KB x 2
L3 Cache             Not Present
EIST                  [Enabled]
C-States              [Disabled]
Intel Virtualization Technology [Disabled]
VT-d                  [Disabled]
Enable/Disable Intel SpeedStep
-----
<->: Select Screen
↑ ↓: Select Item
Enter>Select
F1   General Help
F2   Previous Values
F3   Optimized
     Defaults
F4   Save
ESC  Exit
Version 2.18.1263. Copyright (C) 2020 American Megatrends, Inc.
  
```

BIOS Menu 9: CPU Configuration

→ EIST [Enabled]

Use the **EIST** option to enable or disable the Intel® Speed Step Technology.

- **Disabled** Disables the Intel® Speed Step Technology.
- **Enabled** **DEFAULT** Enables the Intel® Speed Step Technology.

→ C-States [Disabled]

Use the **C-States** option to enable or disable the C-states.

- **Disabled** **DEFAULT** Disables the C-state
- **Enabled** Enables the C-state

→ Intel® Virtualization Technology [Disabled]

Use the **Intel® Virtualization Technology** option to enable or disable virtualization on the system. When combined with third party software, Intel® Virtualization technology allows several OSs to run on the same system at the same time.

→ **Disabled** **DEFAULT** Disables Intel® Virtualization Technology.

→ **Enabled** Enables Intel® Virtualization Technology.

→ VT-d [Disabled]

Use the **VT-d** BIOS option to enable or disabled VT-d support.

→ **Disabled** **DEFAULT** Disable VT-d support.

→ **Enabled** Enable VT-d support.

4.3.7 RTC Wake Settings

The **RTC Wake Settings** menu (**BIOS Menu 10**) configures RTC wake event.

```

Aptio Setup Utility - Copyright (C) 2020 American Megatrends, Inc.
  Advanced
Wake system with Fixed Time      [Disabled]
Enable or disable System
wake on alarm event. When
enabled, System will
wake on the
date::hr::min::sec
specified
-----
←→: Select Screen
↑↓: Select Item
EnterSelect
F1    General Help
F2    Previous Values
F3    Optimized Defaults
F4    Save
ESC   Exit
Version 2.18.1263. Copyright (C) 2020 American Megatrends, Inc.

```

BIOS Menu 10: RTC Wake Settings

IDS-310AI Embedded System

→ Wake system with Fixed Time [Disabled]

Use the **Wake system with Fixed Time** option to enable or disable the system wake on alarm event.

→ **Disabled** **DEFAULT** The real time clock (RTC) cannot generate a wake event

→ **Enabled** If selected, the **Wake up every day** option appears allowing you to enable to disable the system to wake every day at the specified time. Besides, the following options appear with values that can be selected:

Wake up date

Wake up hour

Wake up minute

Wake up second

After setting the alarm, the computer turns itself on from a suspend state when the alarm goes off.

4.3.8 Power Saving Configuration

Use the **Power Saving Configuration** menu (**BIOS Menu 11**) to configure system to reduce power consumption in system off state.

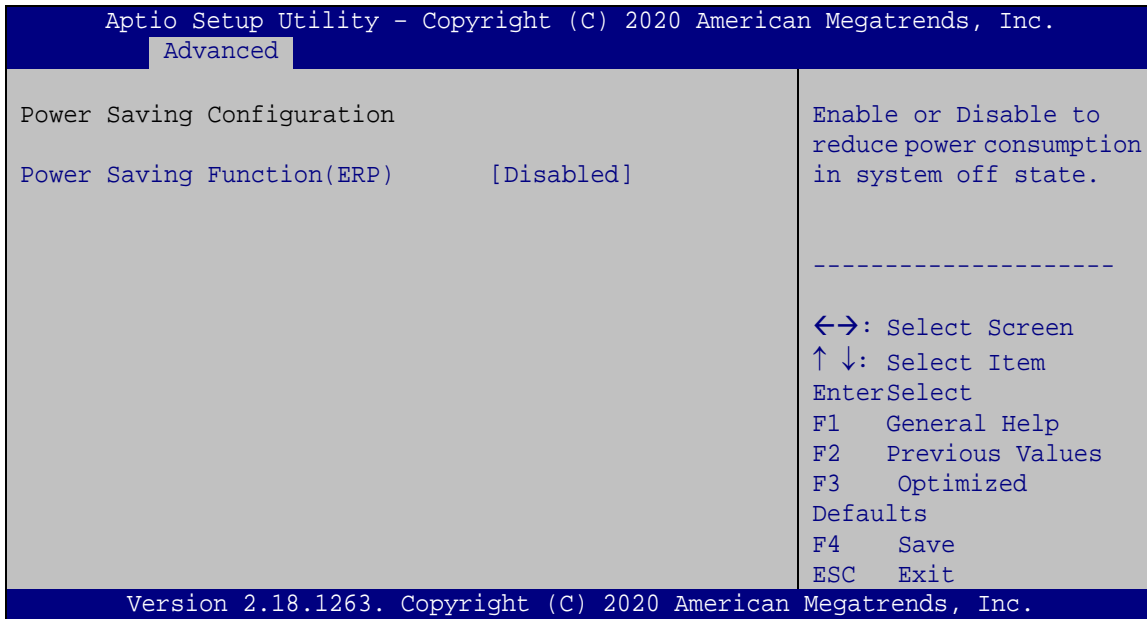

BIOS Menu 11: Power Saving Configuration

➔ Power Saving Function(ERP) [Disabled]

Use the **Power Saving Function** BIOS option to enable or disable the power saving function.

- ➔ **Disabled** **DEFAULT** Power saving function is disabled.
- ➔ **Enabled** Power saving function is enabled. It will reduce power consumption when the system is off.

IDS-310AI Embedded System

4.3.9 Serial Port Console Redirection

The **Serial Port Console Redirection** menu (**BIOS Menu 12**) allows the console redirection options to be configured. Console redirection allows users to maintain a system remotely by re-directing keyboard input and text output through the serial port.

```

Aptio Setup Utility - Copyright (C) 2020 American Megatrends, Inc.
  Advanced
COM1
  Console Redirection [Disabled]
  > Console Redirection Settings
  Legacy Console Redirection
  > Legacy Console Redirection Settings
  Console Redirection
  Enable or Disable
-----
<=>: Select Screen
↑↓: Select Item
Enter>Select
F1  General Help
F2  Previous Values
F3  Optimized
Defaults
F4  Save
ESC Exit
Version 2.18.1263. Copyright (C) 2020 American Megatrends, Inc.
  
```

BIOS Menu 12: Serial Port Console Redirection

→ Console Redirection [Disabled]

Use **Console Redirection** option to enable or disable the console redirection function.

- **Disabled** **DEFAULT** Disabled the console redirection function
- **Enabled** Enabled the console redirection function

4.3.9.1 Console Redirection Settings

The **Console Redirection Settings** menu (**BIOS Menu 13**) allows the console redirection options to be configured. The option is active when Console Redirection option is enabled.

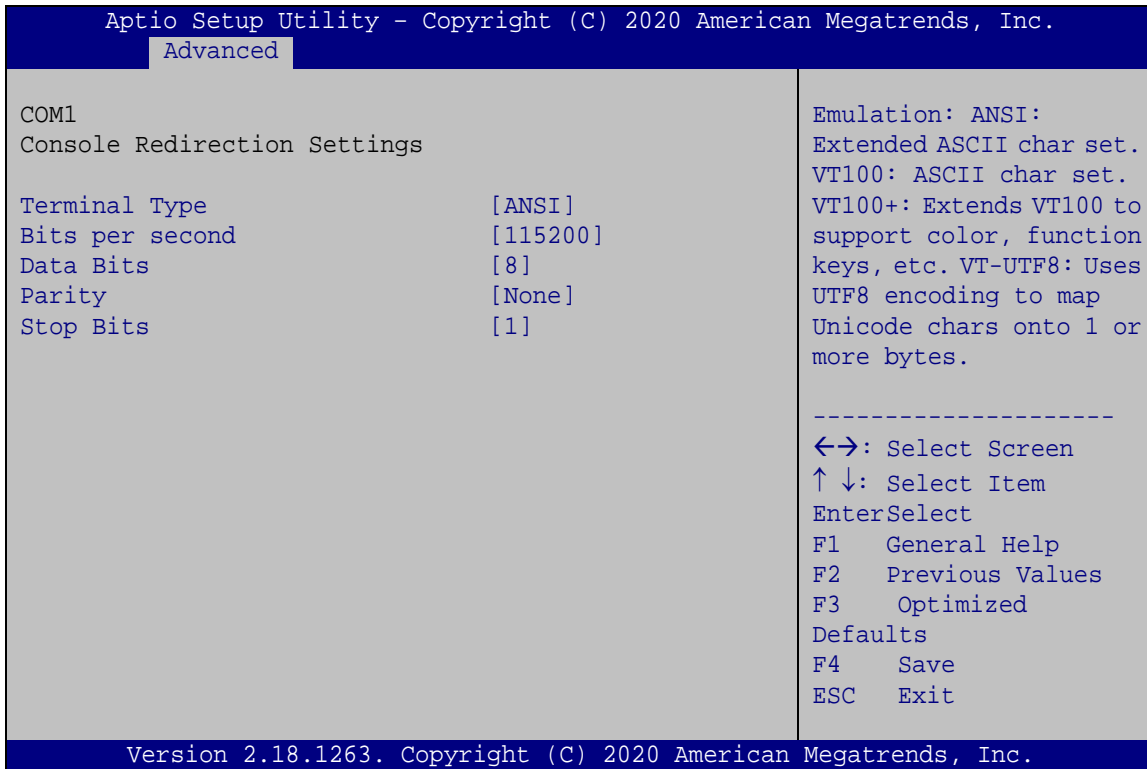

BIOS Menu 13: Console Redirection Settings

→ Terminal Type [ANSI]

Use the **Terminal Type** option to specify the remote terminal type.

- **VT100** The target terminal type is VT100
- **VT100+** The target terminal type is VT100+
- **VT-UTF8** The target terminal type is VT-UTF8
- **ANSI** **DEFAULT** The target terminal type is ANSI

IDS-310AI Embedded System

→ Bits per second [115200]

Use the **Bits per second** option to specify the serial port transmission speed. The speed must match the other side. Long or noisy lines may require lower speeds.

- | | | | |
|---|---------------|----------------|--|
| → | 9600 | | Sets the serial port transmission speed at 9600. |
| → | 19200 | | Sets the serial port transmission speed at 19200. |
| → | 38400 | | Sets the serial port transmission speed at 38400. |
| → | 57600 | | Sets the serial port transmission speed at 57600. |
| → | 115200 | DEFAULT | Sets the serial port transmission speed at 115200. |

→ Data Bits [8]

Use the **Data Bits** option to specify the number of data bits.

- | | | | |
|---|----------|----------------|--------------------------|
| → | 7 | | Sets the data bits at 7. |
| → | 8 | DEFAULT | Sets the data bits at 8. |

→ Parity [None]

Use the **Parity** option to specify the parity bit that can be sent with the data bits for detecting the transmission errors.

- | | | | |
|---|--------------|----------------|---|
| → | None | DEFAULT | No parity bit is sent with the data bits. |
| → | Even | | The parity bit is 0 if the number of ones in the data bits is even. |
| → | Odd | | The parity bit is 0 if the number of ones in the data bits is odd. |
| → | Mark | | The parity bit is always 1. This option does not provide error detection. |
| → | Space | | The parity bit is always 0. This option does not provide error detection. |

→ Stop Bits [1]

Use the **Stop Bits** option to specify the number of stop bits used to indicate the end of a serial data packet. Communication with slow devices may require more than 1 stop bit.

- 1 **DEFAULT** Sets the number of stop bits at 1.
- 2 Sets the number of stop bits at 2.

4.3.9.2 Legacy Console Redirection Settings

The **Legacy Console Redirection Settings** menu (**BIOS Menu 14**) allows the legacy console redirection options to be configured.

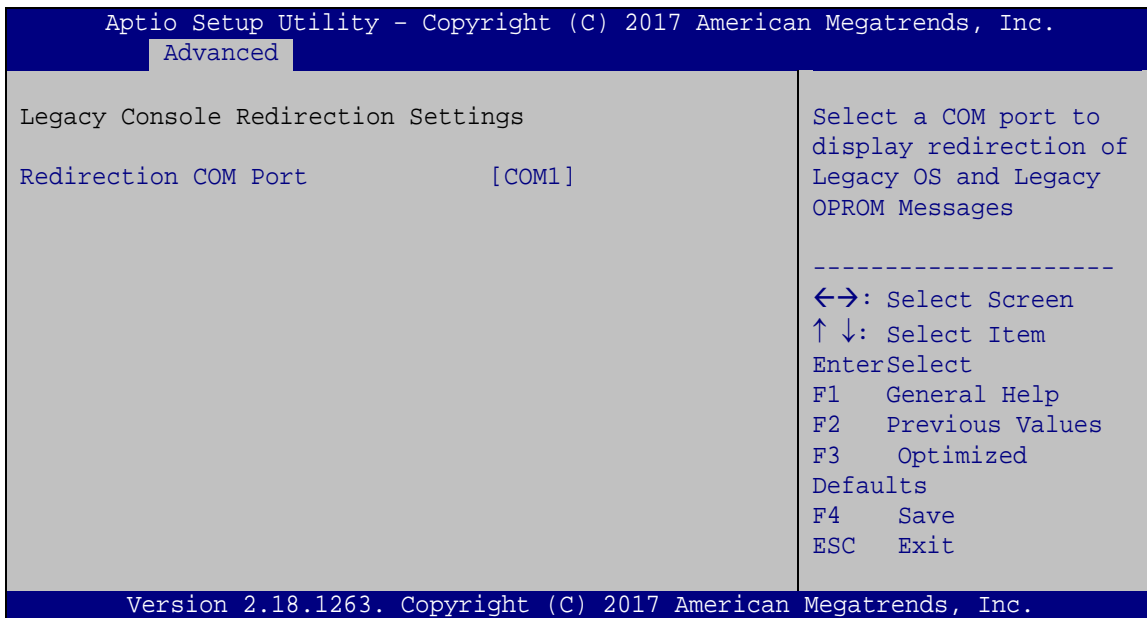

BIOS Menu 14: Legacy Console Redirection Settings

→ Legacy Serial Redirection Port [COM1]

Use the **Legacy Serial Redirection Port** option to specify a COM port to display redirection of legacy OS and legacy OPROM messages. The options include:

- COM1 **DEFAULT**

IDS-310AI Embedded System

4.3.10 IEI Feature

Use the **IEI Feature** menu (**BIOS Menu 15**) to configure One Key Recovery function.

```

Aptio Setup Utility - Copyright (C) 2020 American Megatrends, Inc.
-----
Advanced
-----
iEi Feature
Auto Recovery Function          [Disabled]
                                Auto Recovery Function
                                Reboot and recover
                                system automatically
                                within 10 min, when OS
                                crashes. Please install
                                Auto Recovery API
                                service before enabling
                                this function
                                -----
                                ←→: Select Screen
                                ↑↓: Select Item
                                Enter>Select
                                F1   General Help
                                F2   Previous Values
                                F3   Optimized Defaults
                                F4   Save
                                ESC  Exit
-----
Version 2.18.1263. Copyright (C) 2020 American Megatrends, Inc.

```

BIOS Menu 15: IEI Feature

➔ Auto Recovery Function [Disabled]

Use the **Auto Recovery Function** BIOS option to enable or disable the auto recovery function of the IEI One Key Recovery.

- ➔ **Disabled** **DEFAULT** Auto recovery function disabled
- ➔ **Enabled** Auto recovery function enabled

4.4 Chipset

Use the **Chipset** menu (**BIOS Menu 16**) to access the north bridge and south bridge configuration menus



WARNING!

Setting the wrong values for the Chipset BIOS selections in the Chipset BIOS menu may cause the system to malfunction.

```

Aptio Setup Utility - Copyright (C) 2020 American Megatrends, Inc.
Main   Advanced  Chipset  Security  Boot   Save & Exit
-----
> North Bridge
> South Bridge

North Bridge Parameters
-----
<=>: Select Screen
↑ ↓: Select Item
Enter>Select
+/-: Change Opt.
F1   General Help
F2   Previous Values
F3   Optimized Defaults
F4   Save & Exit
ESC  Exit

Version 2.18.1263. Copyright (C) 2020 American Megatrends, Inc.
    
```

BIOS Menu 16: Chipset

IDS-310AI Embedded System

4.4.1 North Bridge Configuration

Use the **North Bridge Configuration** menu (**BIOS Menu 17**) to configure the Intel IGD settings.

```

Aptio Setup Utility - Copyright (C) 2020 American Megatrends, Inc.
Chipset
> Intel IGD Configuration
> LCD Control

Memory Information
Total Memory          8192 MB(DDR3L)
Dimm1                 8192 MB(DDR3L)

Intel IGD Configuration
-----
<->: Select Screen
↑ ↓: Select Item
EnterSelect
+/-: Change Opt.
F1: General Help
F2: Previous Values
F3: Optimized Defaults
F4: Save & Exit
ESC: Exit

Version 2.18.1263. Copyright (C) 2020 American Megatrends, Inc.
    
```

BIOS Menu 17: North Bridge Configuration

4.4.1.1 Intel IGD Configuration

Use the **Intel IGD Configuration** menu (**BIOS Menu 18**) to configure the video device connected to the system.

```

Aptio Setup Utility - Copyright (C) 2020 American Megatrends, Inc.
Chipset
IGD Configuration
Primary Display      [IGD]
DVMT Pre-Allocated  [256M]
DVMT Total Gfx Mem  [MAX]

IGD: Only IGD Display
PCIe: PCIe + IGD Display
-----
<->: Select Screen
↑ ↓: Select Item
EnterSelect
+/-: Change Opt.
F1: General Help
F2: Previous Values
F3: Optimized Defaults
F4: Save & Exit
ESC: Exit

Version 2.18.1263. Copyright (C) 2020 American Megatrends, Inc.
    
```

BIOS Menu 18: Intel IGD Configuration

→ Primary Display [IGD]

Use the **Primary Display** option to select the display device used by the system when it boots.

- IGD **DEFAULT**

→ DVMT Pre-Allocated [256M]

Use the **DVMT Pre-Allocated** option to set the amount of system memory allocated to the integrated graphics processor when the system boots. The system memory allocated can then only be used as graphics memory, and is no longer available to applications or the operating system. Configuration options are listed below:

- 64M
- 128M
- 256M **DEFAULT**
- 512M

→ DVMT Total Gfx Mem [MAX]

Use the **DVMT Total Gfx Mem** option to select DVMT5.0 total graphic memory size used by the internal graphic device. The following options are available:

- 128M
- 256M
- MAX **DEFAULT**

IDS-310AI Embedded System

4.4.1.2 LCD Control

Use the **LCD Control** submenu (**BIOS Menu 19**) to select a display device which will be activated during POST.

```

Aptio Setup Utility - Copyright (C) 2020 American Megatrends, Inc.
Chipset
LCD Control
Primary IGFX Boot Display      [Auto]

Select the Video Device
which will be activated
during POST. This has no
effect if external
graphics present.
Secondary boot display
selection will appear
based on your selection.
VGA modes will be
supported only on
primary display.

-----
<=>: Select Screen
↑ ↓: Select Item
Enter>Select
+/-: Change Opt.
F1: General Help
F2: Previous Values
F3: Optimized Defaults
F4: Save & Exit
ESC: Exit

Version 2.18.1263. Copyright (C) 2020 American Megatrends, Inc.

```

BIOS Menu 19: LCD Control

→ Primary IGFX Boot Display [Auto]

Use the **Primary IGFX Boot Display** option to select the display device used by the system when it boots.

- Auto **DEFAULT**
- HDMI1
- HDMI2
- HDMI3

4.4.2 South Bridge Configuration

Use the **South Bridge Configuration** menu (**BIOS Menu 20**) to configure the south bridge chipset.

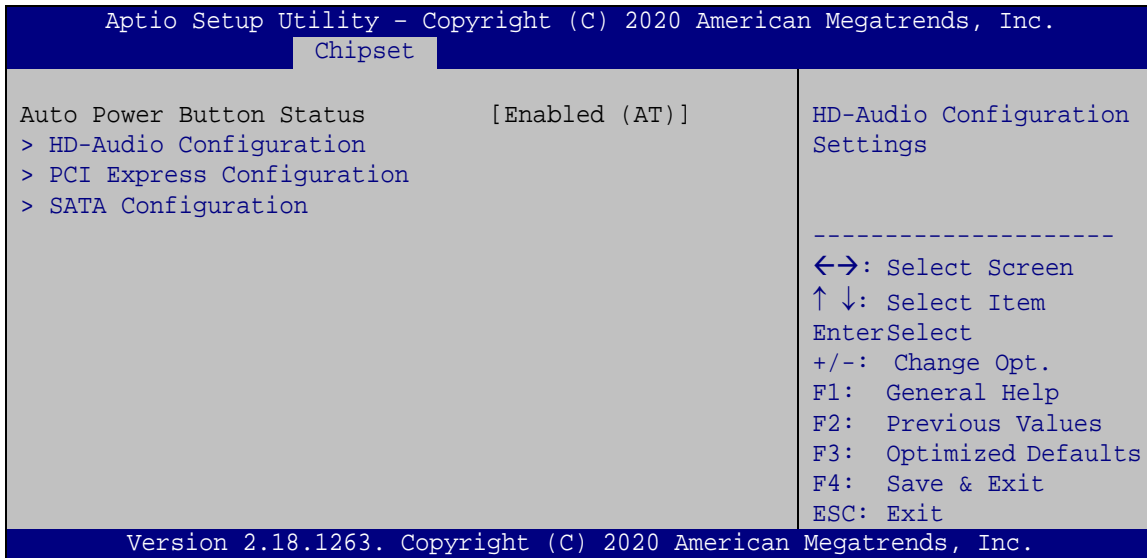

BIOS Menu 20: South Bridge Configuration

4.4.2.1 HD-Audio Configuration

Use the **HD-Audio Configuration** submenu (**BIOS Menu 21**) to configure the HD Audio.

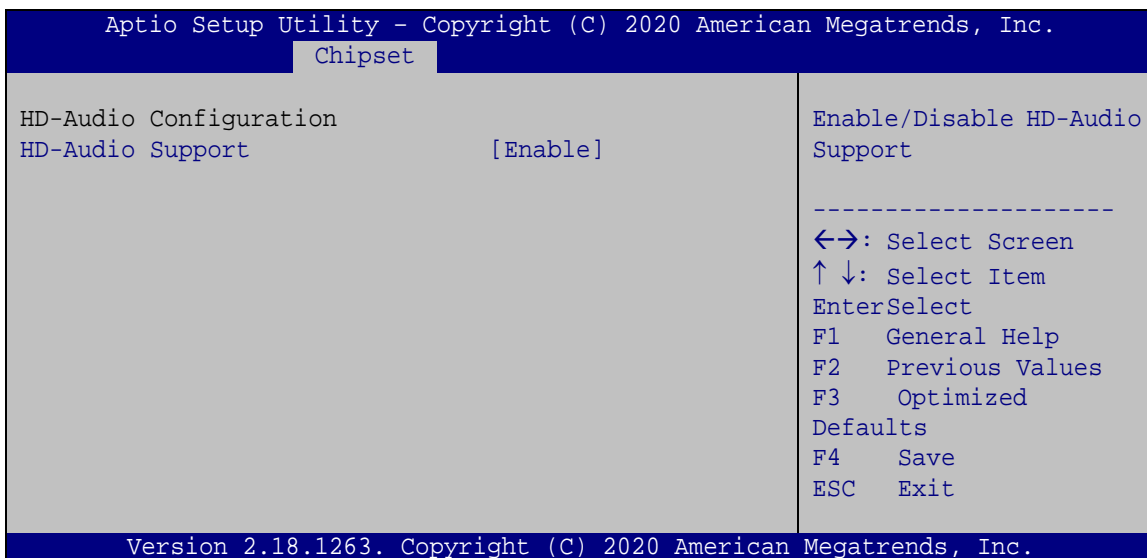

BIOS Menu 21: HD-Audio Configuration

IDS-310AI Embedded System

→ HD-Audio Support [Enable]

Use the **HD-Audio Support** option to enable or disable the High Definition Audio controller.

- **Disable** The onboard High Definition Audio controller is disabled
- **Enable** **DEFAULT** The onboard High Definition Audio controller is detected automatically and enabled

4.4.2.2 PCI Express Configuration

Use the **PCI Express Configuration** submenu (**BIOS Menu 22**) to configure the PCI Express.

```

Aptio Setup Utility - Copyright (C) 2020 American Megatrends, Inc.
Chipset
-----
PCI Express Configuration
> M2_KEYA1
> MPCIE1

Control the PCI Express Root Port.
AUTO: To display unused root port automatically for the most optimum power savings.
Enable: Enable PCIe root port
Disable: Disable PCIe root port

-----
←→: Select Screen
↑ ↓: Select Item
Enter>Select
F1   General Help
F2   Previous Values
F3   Optimized
Defaults
F4   Save
ESC  Exit

Version 2.18.1263. Copyright (C) 2020 American Megatrends, Inc.
    
```

BIOS Menu 22: PCI Express Configuration

4.4.2.2.1 M2_KEYA1

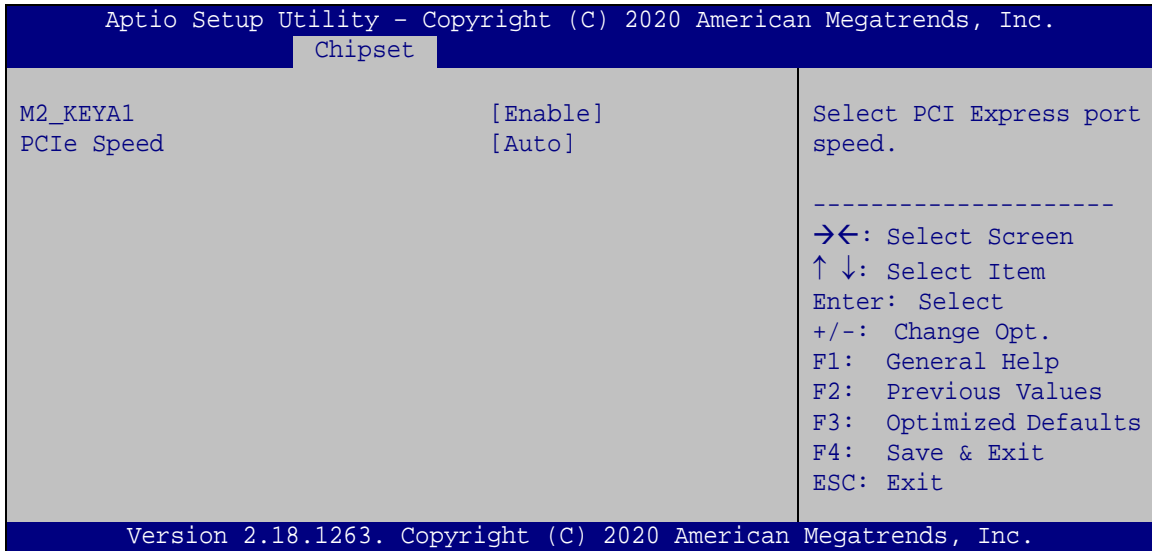

BIOS Menu 23: M2_KEYA1

→ M2_KEYA1 [Enable]

Use the **M2_KEYA1** option to enable or disable the M.2 A-key slot.

- **Disable** The M.2 A-key slot is disabled
- **Enable** **DEFAULT** The M.2 A-key slot is enabled

→ PCIe Speed [Auto]

Use this option to select the support type of the PCI Express slot. The following options are available:

- Auto **Default**
- Gen1
- Gen2

IDS-310AI Embedded System

4.4.2.2.2 MPCIE1

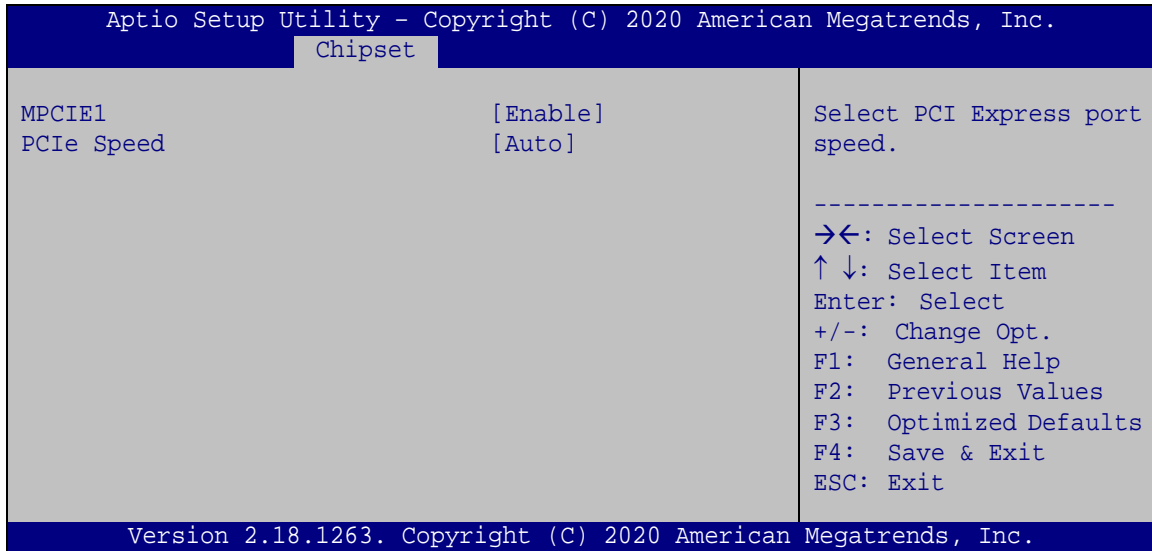

BIOS Menu 24: MPCIE1

→ MPCIE1 [Enable]

Use the **MPCIE1** option to enable or disable the PCIe Mini slot.

- **Disable** The PCIe Mini slot is disabled
- **Enable** **DEFAULT** The PCIe Mini slot is enabled

→ PCIe Speed [Auto]

Use this option to select the support type of the PCI Express slot. The following options are available:

- Auto **Default**
- Gen1
- Gen2

4.4.2.3 SATA Configuration

Use the **SATA Configuration** menu (**BIOS Menu 25**) to change and/or set the configuration of the SATA devices installed in the system.

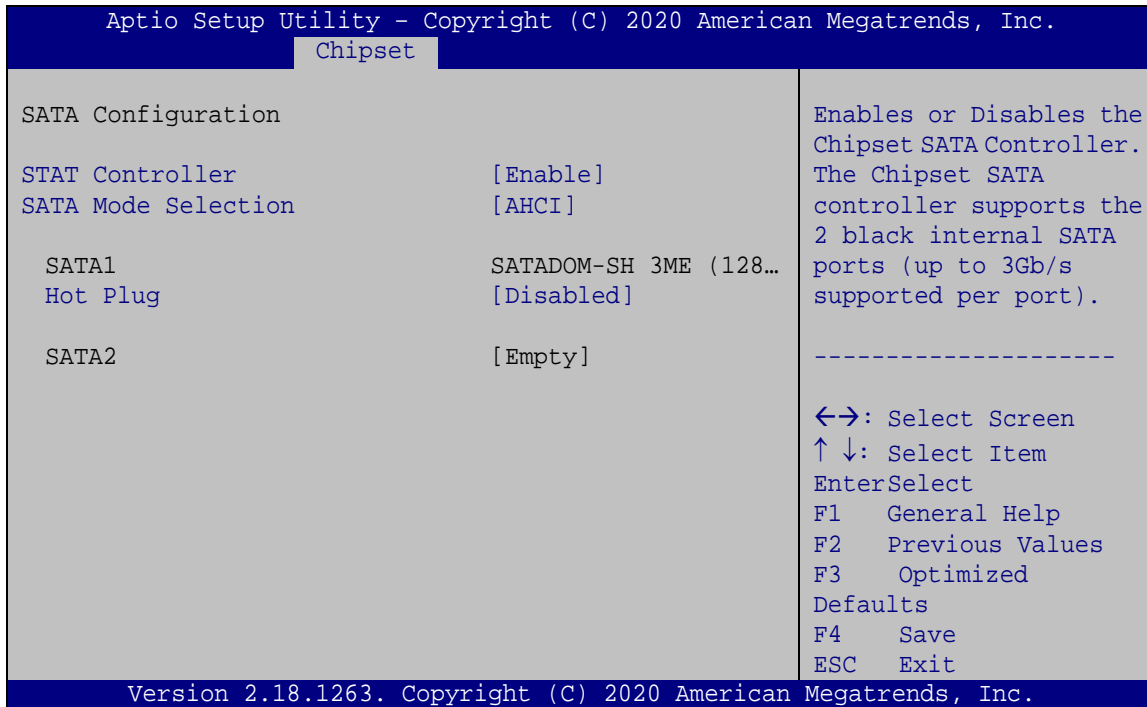

BIOS Menu 25: SATA Configuration

→ SATA Controller [Enable]

Use the **SATA Controller** option to enable or disable the SATA device.

- **Enable** **DEFAULT** Enables the SATA device.
- **Disable** Disables the SATA device.

→ SATA Mode Selection [AHCI]

Use the **SATA Mode Selection** option to configure SATA devices as AHCI devices.

- **AHCI** **DEFAULT** Configures SATA device as AHCI device.

IDS-310AI Embedded System

→ Hot Plug [Disabled]

Use the **Hot Plug** option to enable or disable the SATA device hot plug.

- **Disabled** **DEFAULT** Disables the SATA device hot plug.
- **Enabled** Enables the SATA device hot plug

4.5 Security

Use the **Security** menu (**BIOS Menu 26**) to set system and user passwords.

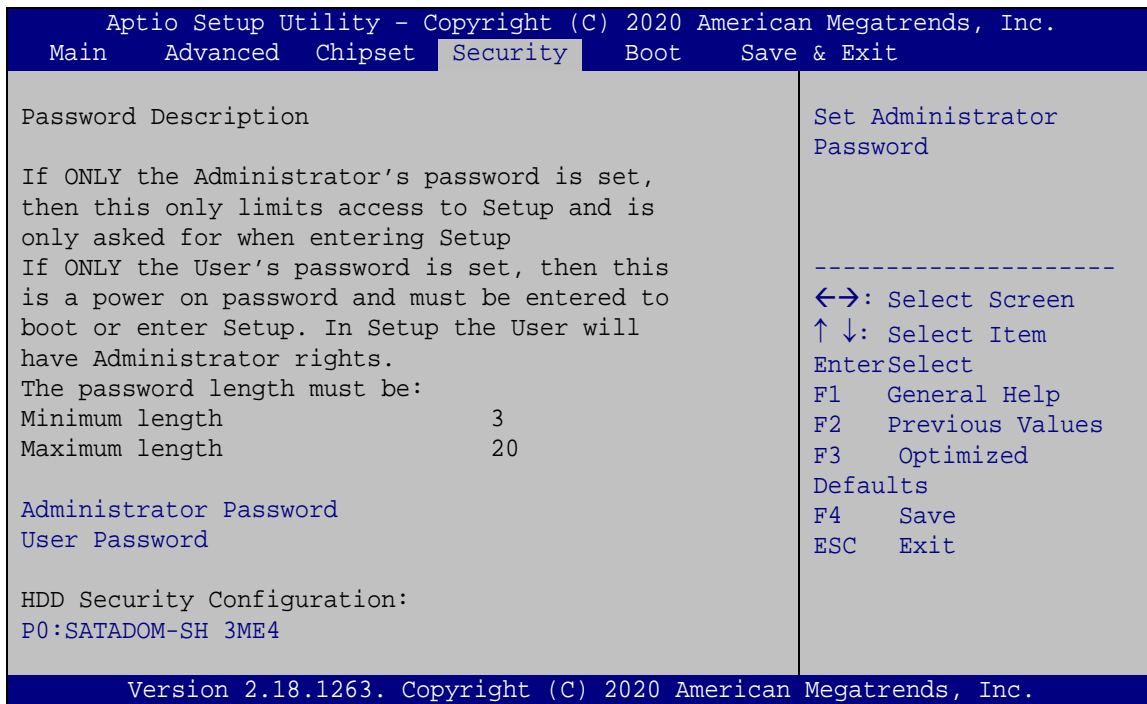

BIOS Menu 26: Security

→ Administrator Password

Use the **Administrator Password** to set or change an administrator password.

→ User Password

Use the **User Password** to set or change a user password.

4.6 Boot

Use the **Boot** menu (**BIOS Menu 27**) to configure system boot options.

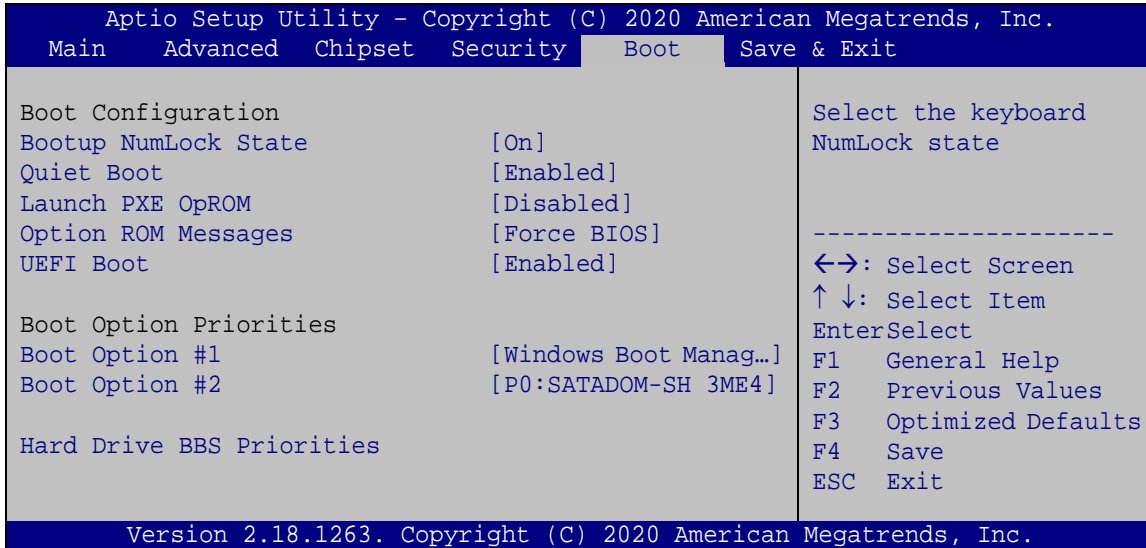

BIOS Menu 27: Boot

→ Bootup NumLock State [On]

Use the **Bootup NumLock State** BIOS option to specify if the number lock setting must be modified during boot up.

- **On** **DEFAULT** Allows the Number Lock on the keyboard to be enabled automatically when the computer system boots up. This allows the immediate use of the 10-key numeric keypad located on the right side of the keyboard. To confirm this, the Number Lock LED light on the keyboard is lit.

- **Off** Does not enable the keyboard Number Lock automatically. To use the 10-keys on the keyboard, press the Number Lock key located on the upper left-hand corner of the 10-key pad. The Number Lock LED on the keyboard lights up when the Number Lock is engaged.

IDS-310AI Embedded System

→ Quiet Boot [Enabled]

Use the **Quiet Boot** BIOS option to select the screen display when the system boots.

- **Disabled** Normal POST messages displayed
- **Enabled** **DEFAULT** OEM Logo displayed instead of POST messages

→ Launch PXE OpROM [Disabled]

Use the **Launch PXE OpROM** option to enable or disable boot option for legacy network devices.

- **Disabled** **DEFAULT** Ignore all PXE Option ROMs
- **Enabled** Load PXE Option ROMs

→ Option ROM Messages [Force BIOS]

Use the **Option ROM Messages** option to set the Option ROM display mode.

- **Force BIOS** **DEFAULT** Sets display mode to force BIOS.
- **Keep Current** Sets display mode to current.

→ UEFI Boot [Disabled]

Use the **UEFI Boot** BIOS option to enable or disable UEFI boot.

- **Enabled** Enable UEFI boot if the 1st boot device is a GPT HDD.
- **Disabled** **DEFAULT** Disable UEFI boot.

→ Boot Option Priority

Use the **Boot Option Priority** function to set the system boot sequence from the available devices. The drive sequence also depends on the boot sequence in the individual device section.

4.7 Save & Exit

Use the **Exit** menu (**BIOS Menu 28**) to load default BIOS values, optimal failsafe values and to save configuration changes.

```

Aptio Setup Utility - Copyright (C) 2020 American Megatrends, Inc.
Main   Advanced  Chipset  Security  Boot   Save & Exit
-----
Save Changes and Reset
Discard Changes and Reset

Restore Defaults
Save as User Defaults
Restore User Defaults

Reset the system after
saving the changes.

-----
<->: Select Screen
↑ ↓: Select Item
Enter>Select
F1   General Help
F2   Previous Values
F3   Optimized
Defaults
F4   Save
ESC  Exit

Version 2.18.1263. Copyright (C) 2020 American Megatrends, Inc.

```

BIOS Menu 28: Save & Exit

→ Save Changes and Reset

Use the **Save Changes and Reset** option to save the changes made to the BIOS options and to exit the BIOS configuration setup program.

→ Discard Changes and Reset

Use the **Discard Changes and Reset** option to exit the system without saving the changes made to the BIOS configuration setup program.

→ Restore Defaults

Use the **Restore Defaults** option to load the optimal default values for each of the parameters on the Setup menus. **F3 key can be used for this operation.**

IDS-310AI Embedded System

→ Save as User Defaults

Use the **Save as User Defaults** option to save the changes done so far as user defaults.

→ Restore User Defaults

Use the **Restore User Defaults** option to restore the user defaults to all the setup options.

Chapter

5

Maintenance

IDS-310AI Embedded System



WARNING:

Take Anti-Static precautions whenever maintenance is being carried out on the system components. Failure to take anti-static precautions can cause permanent system damage. For more details on anti-static precautions, please refer to **Section 3.1**.

5.1 System Maintenance Overview



NOTE:

When doing maintenance operations on the system, please follow the instructions in this chapter. Failure to follow these instructions may lead to personal injury and system damage.

To preserve the working integrity of the IDS-310AI, the system must be properly maintained. If internal components need replacement, the proper maintenance procedures must be followed to ensure the system can continue to operate normally.

5.2 Component Replacement Procedure



WARNING!

Users are not advised to attempt to repair or replace any internal or external components of the IDS-310AI other than those listed below. If any other components fail or need replacement, contact the IEI reseller or vendor you purchased the IDS-310AI from or contact an IEI sales representative directly. To contact an IEI sales representative, please send an email to sales@ieiworld.com.

The system components listed below can all be replaced if they fail:

- SO-DIMM module

- Wi-Fi module (see Section 3.4)

5.2.1 SO-DIMM Replacement



WARNING:

Using incorrectly specified SO-DIMM may cause permanently damage the IDS-310AI. Please make sure the purchased SO-DIMM complies with the memory specifications of the IDS-310AI.

To replace a SO-DIMM memory module into a SO-DIMM socket, please follow the steps below.

Step 1: Remove the bottom surface. See **Section 3.3**.

Step 2: Locate the SO-DIMM inside the bottom panel (**Figure 5-1**).

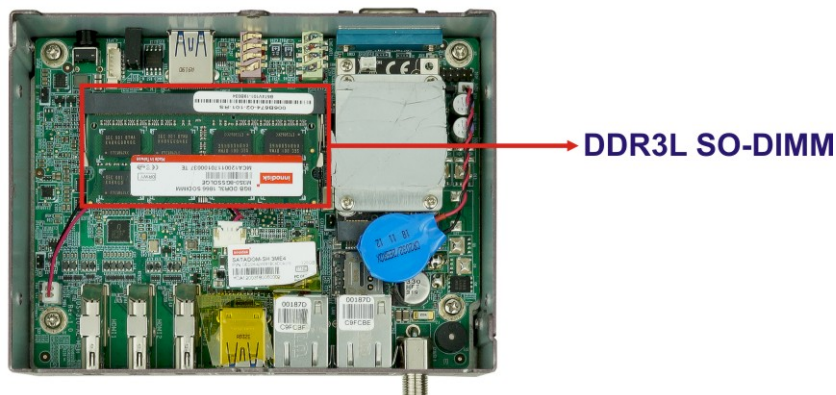

Figure 5-1: SO-DIMM Location

Step 3: Remove the SO-DIMM by releasing the arms on the SO-DIMM socket. Align the new SO-DIMM with the socket. The SO-DIMM must be oriented in such a way that the notch in the middle of the SO-DIMM must be aligned with the plastic bridge in the socket (**Figure 5-2**).

Step 4: Insert the SO-DIMM. Push the SO-DIMM chip into the socket at an angle (**Figure 5-2**).

IDS-310AI Embedded System

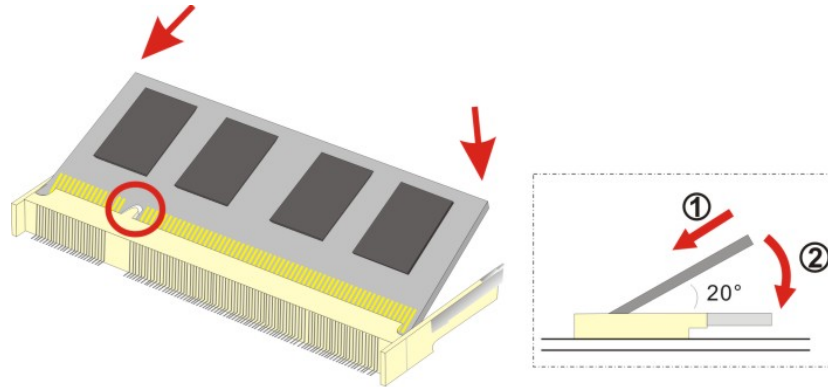

Figure 5-2: SO-DIMM Installation

- Step 5:** Secure the SO-DIMM. Press the SO-DIMM down until the arms of the SO-DIMM socket clip into place and secure the SO-DIMM in the socket.

Chapter

6

Interface Connectors

IDS-310AI Embedded System

6.1 Peripheral Interface Connectors

The IDS-310AI' motherboard comes with a number of peripheral interface connectors and configuration jumpers. The connector locations are shown in **Figure 6-1**. The Pin 1 locations of the on-board connectors are also indicated in the diagrams below. The connector pinouts for these connectors are listed in the following sections.

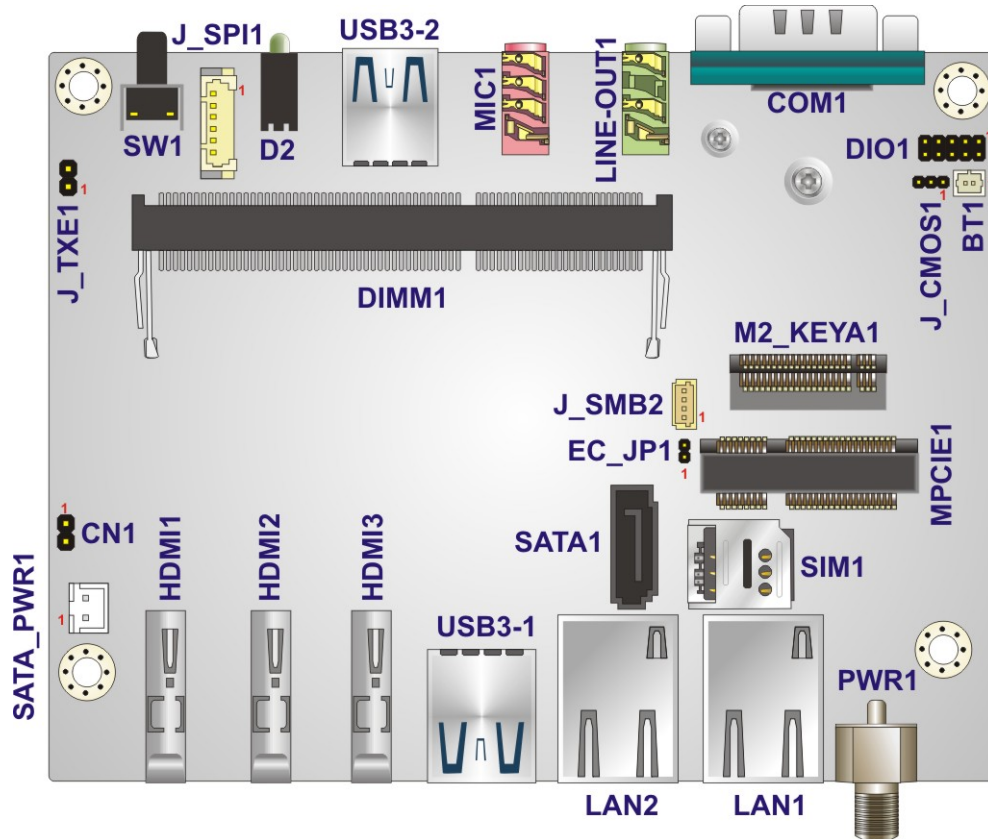

Figure 6-1: Main Board Layout Diagram

6.2 Internal Peripheral Connectors

Internal peripheral connectors are found on the motherboard and are only accessible when the motherboard is outside of the chassis. Pinouts of the internal connectors listed in **Table 6-1** can be found in the following sections.

Connector	Type	Label
Battery connector	2-pin wafer	BT1
Digital I/O connector	10-pin header	DIO1
Firmware programming connector for CH7525	2-pin header	CN1
M.2 A-key slot	M.2 A-key 2230 slot	M2_KEYA1
PCIe Mini card slot	Full-size PCIe Mini slot	MPCIE1
SATA connector	7-pin connector	SATA1
SATA power connector	2-pin wafer	SATA_PWR1
SIM card slot	SIM slot	SIM1
SMBus connector	4-pin wafer	J_SMB2
SO-DIMM connector	SO-DIMM connector	DIMM1
SPI Flash connector, BIOS	6-pin wafer	J_SPI1
SPI Flash connector, EC	2-pin header	EC_JP1

Table 6-1: Peripheral Interface Connectors

6.2.1 Battery Connector (BT1)

PIN NO.	DESCRIPTION
1	VBATT
2	GND

Table 6-2: Battery Connector (BT1) Pinouts

IDS-310AI Embedded System

6.2.2 Digital I/O Connector (DIO1)

PIN NO.	DESCRIPTION	PIN NO.	DESCRIPTION
1	GND	2	+5V
3	DOUT3	4	DOUT2
5	DOUT1	6	DOUT0
7	DIN3	8	DIN2
9	DIN1	10	DIN0

Table 6-3: Digital I/O Connector (DIO1) Pinouts

6.2.3 Firmware Programming Connector for CH7525 (CN1)

PIN NO.	DESCRIPTION
1	SMB_CLK_FW
2	SMB_DATA_FW

Table 6-4: Firmware Programming Connector for CH7525 (CN1) Pinouts

6.2.4 M.2 A-key Slot (M2_KEYA1)

PIN NO.	DESCRIPTION	PIN NO.	DESCRIPTION
1	GND	2	+V3.3A
3	USB+	4	+V3.3A
5	USB-	6	NC
7	GND	8	Module Key
9	Module Key	10	Module Key
11	Module Key	12	Module Key
13	Module Key	14	Module Key
15	Module Key	16	NC
17	NC	18	GND
19	NC	20	NC
21	NC	22	NC
23	GND	24	GND

PIN NO.	DESCRIPTION	PIN NO.	DESCRIPTION
25	NC	26	NC
27	NC	28	NC
29	GND	30	GND
31	NC	32	NC
33	GND	34	NC
35	PCIE_TX+	36	GND
37	PCIE_TX-	38	NC
39	GND	40	NC
41	PCIE_RX+	42	NC
43	PCIE_RX-	44	NC
45	GND	46	NC
47	CLK_PCIE+	48	NC
49	CLK_PCIE-	50	NC
51	GND	52	BUF_PLT_RST#
53	PCIE_CLKREQ#	54	Pull Up +V3.3A
55	PCIE_WAKE#	56	Pull Up +V3.3A
57	GND	58	NC
59	NC	60	NC
61	NC	62	NC
63	GND	64	NC
65	NC	66	NC
67	NC	68	NC
69	GND	70	NC
71	NC	72	+V3.3A
73	NC	74	+V3.3A
75	GND		

Table 6-5: M.2 A-key Slot (M2_KEYA1) Pinouts

IDS-310AI Embedded System

6.2.5 PCIe Mini Slot (MPCIE1)

PIN NO.	DESCRIPTION	PIN NO.	DESCRIPTION
1	PCIE_WAKE#	2	+3.3V
3	N/C	4	GND
5	N/C	6	+1.5V
7	N/C	8	N/C
9	GND	10	N/C
11	CLK-	12	N/C
13	CLK+	14	N/C
15	GND	16	N/C
17	PCIRST#	18	GND
19	N/C	20	+3.3V
21	GND	22	PCIRST#
23	PERN (SATA_RX+)	24	+3VDual
25	PERP (SATA_RX-)	26	GND
27	GND	28	+1.5V
29	GND	30	SMBCLK
31	PETN (SATA_TX-)	32	SMBDATA
33	PETP (SATA_TX+)	34	GND
35	GND	36	USBD-
37	N/C	38	USBD+
39	N/C	40	GND
41	N/C	42	N/C
43	N/C	44	N/C
45	N/C	46	N/C
47	N/C	48	+1.5V
49	N/C	50	GND
51	MSATA_SEL#	52	+3.3V

Table 6-6: PCIe Mini Slot (MPCIE1) Pinouts

6.2.6 SATA Connector (SATA1)

PIN NO.	DESCRIPTION
1	GND
2	TX+
3	TX-
4	GND
5	RX-
6	RX+
7	GND

Table 6-7: SATA Connector (SATA1) Pinouts

6.2.7 SATA Power Connector (SATA_PWR1)

PIN NO.	DESCRIPTION
1	+5V
2	GND

Table 6-8: SATA Power Connector (SATA_PWR1) Pinouts

6.2.8 SMBus Connector (J_SMB2)

PIN NO.	DESCRIPTION
1	GND
2	SMB_DATA_EC
3	SMB_CLK_EC
4	+5V

Table 6-9: SMBus Connector (J_SMB2) Pinouts

IDS-310AI Embedded System

6.2.9 SPI Flash Connector, BIOS (J_SPI1)

PIN NO.	DESCRIPTION
1	+V3.3M_SPI_CON
2	SPI_CS
3	SPI_SO_SW
4	SPI_CLK_SW
5	SPI_SI_SW
6	GND

Table 6-10: SPI Flash Connector (J_SPI1) Pinouts

6.2.10 SPI Flash Connector, EC (EC_JP1)

PIN NO.	DESCRIPTION
1	SMB_CLK_FW
2	SMB_DATA_FW

Table 6-11: SPI Flash Connector (EC_JP1) Pinouts

6.3 External Interface Panel Connectors

The table below lists the I/O panel connectors on the IDS-310AI motherboard. Pinouts for these connectors can be found in **Section 3.7**.

Connector	Type	Label
Ethernet connectors	RJ-45	LAN1, LAN2
HDMI connectors	HDMI port	HDMI1, HDMI2, HDMI3
Power connector	4-pin DIN connector	PWR1
RS-232/422/485 connector	RJ-45	COM1
USB 3.2 Gen 1 connectors	USB Type A	USB3-1, USB3-2

Table 6-12: External Interface Panel Connectors

Appendix

A

Regulatory Compliance

DECLARATION OF CONFORMITY

This equipment is in conformity with the following EU directives:

- EMC Directive (2004/108/EC, 2014/30/EU)
- Low-Voltage Directive (2006/95/EC, 2014/35/EU)
- RoHS II Directive (2011/65/EU, 2015/863/EU)
- Ecodesign Directive 2009/125/EC

If the user modifies and/or install other devices in the equipment, the CE conformity declaration may no longer apply.

If this equipment has telecommunications functionality, it also complies with the requirements of the Radio Equipment Directive 2014/53/EU.

English

IEI Integration Corp declares that this equipment is in compliance with the essential requirements and other relevant provisions of Directive 2014/53/EU.

Български [Bulgarian]

IEI Integration Corp. декларира, че този оборудване е в съответствие със съществените изисквания и другите приложими правила на Директива 2014/53/EU.

Česky [Czech]

IEI Integration Corp tímto prohlašuje, že tento zařizení je ve shodě se základními požadavky a dalšími příslušnými ustanoveními směrnice 2014/53/EU.

Dansk [Danish]

IEI Integration Corp erklærer herved, at følgende udstyr overholder de væsentlige krav og øvrige relevante krav i direktiv 2014/53/EU

Deutsch [German]

IEI Integration Corp, erklärt dieses Gerät entspricht den grundlegenden Anforderungen und den weiteren entsprechenden Vorgaben der Richtlinie 2014/53/EU.

Eesti [Estonian]

IEI Integration Corp deklareerib seadme seadme vastavust direktiivi 2014/53/EÜ põhinõuetele ja nimetatud direktiivist tulenevatele teistele asjakohastele sätetele.

Español [Spanish]

IEI Integration Corp declara que el equipo cumple con los requisitos esenciales y cualesquiera otras disposiciones aplicables o exigibles de la Directiva 2014/53/EU.

Ελληνική [Greek]

IEI Integration Corp ΔΗΛΩΝΕΙ ΟΤΙ ΕΞΟΠΛΙΣΜΟΣ ΣΥΜΜΟΡΦΩΝΕΤΑΙ ΠΡΟΣ ΤΙΣ ΟΥΣΙΩΔΕΙΣ ΑΠΑΙΤΗΣΕΙΣ ΚΑΙ ΤΙΣ ΛΟΙΠΕΣ ΣΧΕΤΙΚΕΣ ΔΙΑΤΑΞΕΙΣ ΤΗΣ ΟΔΗΓΙΑΣ 2014/53/EU.

Français [French]

IEI Integration Corp déclare que l'appareil est conforme aux exigences essentielles et aux autres dispositions pertinentes de la directive 2014/53/EU.

Italiano [Italian]

IEI Integration Corp dichiara che questo apparecchio è conforme ai requisiti essenziali ed alle altre disposizioni pertinenti stabilite dalla direttiva 2014/53/EU.

Latviski [Latvian]

IEI Integration Corp deklarē, ka iekārta atbilst būtiskajām prasībām un citiem ar to saistītajiem noteikumiem Direktīvas 2014/53/EU.

Lietuvių [Lithuanian]

IEI Integration Corp deklaruoja, kad šis įranga atitinka esminius reikalavimus ir kitas 2014/53/EU Direktyvos nuostatas.

Nederlands [Dutch]

IEI Integration Corp dat het toestel toestel in overeenstemming is met de essentiële eisen en de andere relevante bepalingen van richtlijn 2014/53/EU.

Malti [Maltese]

IEI Integration Corp jiddikjara li dan prodott jikkonforma mal-ftigijiet essenzjali u ma provvedimenti oħrajn rilevanti li hemm fid-Direttiva 2014/53/EU.

Magyar [Hungarian]

IEI Integration Corp nyilatkozom, hogy a berendezés megfelel a vonatkozó alapvető követelményeknek és az 2014/53/EU irányelvének egyéb előírásainak.

Polski [Polish]

IEI Integration Corp oświadcza, że wyrobu jest zgodny z zasadniczymi wymogami oraz pozostałymi stosownymi postanowieniami Dyrektywy 2014/53/EU.

Português [Portuguese]

IEI Integration Corp declara que este equipamen^{to} está conforme com os requisitos essenciais e outras disposições da Directiva 2014/53/EU.

IDS-310AI Embedded System

Româna [Romanian]

IEI Integration Corp declară că acest echipament este în conformitate cu cerințele esențiale și cu celelalte prevederi relevante ale Directivei 2014/53/EU.

Slovensko [Slovenian]

IEI Integration Corp izjavlja, da je ta opreme v skladu z bistvenimi zahtevami in ostalimi relevantnimi določili direktive 2014/53/EU.

Slovensky [Slovak]

IEI Integration Corp týmto vyhlasuje, že zariadenia spĺňa základné požiadavky a všetky príslušné ustanovenia Smernice 2014/53/EU.

Suomi [Finnish]

IEI Integration Corp vakuuttaa täten että laitteet on direktiivin 2014/53/EU oleellisten vaatimusten ja sitä koskevien direktiivin muiden ehtojen mukainen.

Svenska [Swedish]

IEI Integration Corp förklarar att denna utrustningstyp står i överensstämmelse med de väsentliga egenskapskrav och övriga relevanta bestämmelser som framgår av direktiv 2014/53/EU.

FCC WARNING

This equipment complies with Part 15 of the FCC Rules. Operation is subject to the following two conditions:

- This device may not cause harmful interference, and
- This device must accept any interference received, including interference that may cause undesired operation.

This equipment has been tested and found to comply with the limits for a Class A digital device, pursuant to part 15 of the FCC Rules. These limits are designed to provide reasonable protection against harmful interference when the equipment is operated in a commercial environment. This equipment generates, uses, and can radiate radio frequency energy and, if not installed and used in accordance with the instruction manual, may cause harmful interference to radio communications. Operation of this equipment in a residential area is likely to cause harmful interference in which case the user will be required to correct the interference at his own expense.

Federal Communication Commission Interference Statement

This equipment has been assembled with components that comply with the limits for a Class B digital device, pursuant to Part 15 of the FCC Rules. These limits are designed to provide reasonable protection against harmful interference in a residential installation. This equipment generates, uses and can radiate radio frequency energy and, if not installed and used in accordance with the instructions, may cause harmful interference to radio communications. However, there is no guarantee that interference will not occur in a particular installation. If this equipment does cause harmful interference to radio or television reception, which can be determined by turning the equipment off and on, the user is encouraged to try to correct the interference by one of the following measures:

- Reorient or relocate the receiving antenna.
- Increase the separation between the equipment and receiver.
- Connect the equipment into an outlet on a circuit different from that to which the receiver is connected.
- Consult the dealer or an experienced radio/TV technician for help.

Appendix

B

Safety Precautions

**WARNING:**

The precautions outlined in this chapter should be strictly followed. Failure to follow these precautions may result in permanent damage to the IDS-310AI.

B.1 Safety Precautions

Please follow the safety precautions outlined in the sections that follow:

B.1.1 General Safety Precautions

Please ensure the following safety precautions are adhered to at all times.

- **Follow the electrostatic precautions** outlined below whenever the device is opened.
- **Make sure the power is turned off and the power cord is disconnected** whenever the IDS-310AI is being installed, moved or modified.
- **To prevent the risk of electric shock, make sure power cord is unplugged from wall socket.** To fully disengage the power to the unit, please disconnect the power cord from the AC outlet. Refer servicing to qualified service personnel. The AC outlet shall be readily available and accessible.
- **Do not apply voltage levels that exceed the specified voltage range.** Doing so may cause fire and/or an electrical shock. Use a power cord that matches the voltage of the power outlet, which has been approved and complies with the safety standard of your particular country.
- **Electric shocks can occur** if the IDS-310AI chassis is opened when it is running. To avoid risk of electric shock, this device must only be connected to a supply mains with protective earth.
- **Do not drop or insert any objects** into the ventilation openings of the IDS-310AI.

IDS-310AI Embedded System

- **If considerable amounts of dust, water, or fluids enter the device**, turn off the power supply immediately, unplug the power cord, and contact the IDS-310AI vendor.
- **DO NOT:**
 - Drop the device against a hard surface.
 - In a site where the ambient temperature exceeds the rated temperature

B.1.2 Anti-static Precautions



WARNING:

Failure to take ESD precautions during the installation of the IDS-310AI may result in permanent damage to the IDS-310AI and severe injury to the user.

Electrostatic discharge (ESD) can cause serious damage to electronic components, including the IDS-310AI. Dry climates are especially susceptible to ESD. It is therefore critical that whenever the IDS-310AI is opened and any of the electrical components are handled, the following anti-static precautions are strictly adhered to.

- **Wear an anti-static wristband:** Wearing a simple anti-static wristband can help to prevent ESD from damaging any electrical component.
- **Self-grounding:** Before handling any electrical component, touch any grounded conducting material. During the time the electrical component is handled, frequently touch any conducting materials that are connected to the ground.
- **Use an anti-static pad:** When configuring or working with an electrical component, place it on an anti-static pad. This reduces the possibility of ESD damage.
- **Only handle the edges of the electrical component:** When handling the electrical component, hold the electrical component by its edges.

B.1.3 Product Disposal

**CAUTION:**

Risk of explosion if battery is replaced by an incorrect type. Only certified engineers should replace the on-board battery.

Dispose of used batteries according to instructions and local regulations.

- Outside the European Union–If you wish to dispose of used electrical and electronic products outside the European Union, please contact your local authority so as to comply with the correct disposal method.
- Within the European Union–The device that produces less waste and is easier to recycle is classified as electronic device in terms of the European Directive 2012/19/EU (WEEE), and must not be disposed of as domestic garbage.

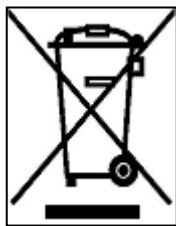

EU-wide legislation, as implemented in each Member State, requires that waste electrical and electronic products carrying the mark (left) must be disposed of separately from normal household waste. This includes monitors and electrical accessories, such as signal cables or power cords. When you need to dispose of your display products, please follow the guidance of your local authority, or ask the shop where you purchased the product. The mark on electrical and electronic products only applies to the current European Union Member States.

Please follow the national guidelines for electrical and electronic product disposal.

IDS-310AI Embedded System

B.2 Maintenance and Cleaning Precautions

When maintaining or cleaning the IDS-310AI, please follow the guidelines below.



WARNING:

- For safety reasons, turn-off the power and unplug the system before cleaning.
 - If you dropped any material or liquid such as water onto the IDS-310AI when cleaning, unplug the power cable immediately and contact your dealer or the nearest service center. Always make sure your hands are dry when unplugging the power cable.
-

B.2.1 Maintenance and Cleaning

Prior to cleaning any part or component of the IDS-310AI, please read the details below.

- Never spray or squirt liquids directly onto any other components.
- The interior of the device does not require cleaning. Keep fluids away from the device interior.
- Be cautious of all small removable components when vacuuming the device.
- Never drop any objects or liquids through the openings of the device.
- Be cautious of any possible allergic reactions to solvents or chemicals used when cleaning the device.
- Avoid eating, drinking and smoking within vicinity of the device.

B.2.2 Cleaning Tools

Some components in the IDS-310AI may only be cleaned using a product specifically designed for the purpose. In such case, the product will be explicitly mentioned in the cleaning tips. Below is a list of items to use when cleaning the IDS-310AI.

- **Cloth**— Although paper towels or tissues can be used, a soft, clean piece of cloth is recommended when cleaning the device.
- **Water or rubbing alcohol**—A cloth moistened with water or rubbing alcohol can be used to clean the device.
- **Using solvents**—The use of solvents is not recommended when cleaning the

device as they may damage the plastic parts.

- **Vacuum cleaner**—Using a vacuum specifically designed for computers is one of the best methods of cleaning the device. Dust and dirt can restrict the airflow in the device and cause its circuitry to corrode.
- **Cotton swabs**—Cotton swabs moistened with rubbing alcohol or water are excellent tools for wiping hard to reach areas.
- **Foam swabs**—Whenever possible, it is best to use lint free swabs such as foam swabs for cleaning.

Appendix

C

BIOS Menu Options

C.1 BIOS Configuration Options

Below is a list of BIOS configuration options described in **Chapter 4**.

<input type="checkbox"/>	System Date [xx/xx/xx]	31
<input type="checkbox"/>	System Time [xx:xx:xx]	31
<input type="checkbox"/>	Security Device Support [Enable]	33
<input type="checkbox"/>	TPM State [Enabled]	33
<input type="checkbox"/>	Pending Operation [None]	33
<input type="checkbox"/>	ACPI Sleep State [S3 (Suspend to RAM)]	34
<input type="checkbox"/>	Serial Port [Enabled]	36
<input type="checkbox"/>	Transfer Mode [RS232]	36
<input type="checkbox"/>	PC Health Status	37
<input type="checkbox"/>	USB Devices	38
<input type="checkbox"/>	Legacy USB Support [Enabled]	38
<input type="checkbox"/>	EIST [Enabled]	39
<input type="checkbox"/>	C-States [Disabled]	39
<input type="checkbox"/>	Intel® Virtualization Technology [Disabled]	40
<input type="checkbox"/>	VT-d [Disabled]	40
<input type="checkbox"/>	Wake system with Fixed Time [Disabled]	41
<input type="checkbox"/>	Power Saving Function(ERP) [Disabled]	42
<input type="checkbox"/>	Console Redirection [Disabled]	43
<input type="checkbox"/>	Terminal Type [ANSI]	44
<input type="checkbox"/>	Bits per second [115200]	45
<input type="checkbox"/>	Data Bits [8]	45
<input type="checkbox"/>	Parity [None]	45
<input type="checkbox"/>	Stop Bits [1]	46
<input type="checkbox"/>	Legacy Serial Redirection Port [COM1]	46
<input type="checkbox"/>	Auto Recovery Function [Disabled]	47
<input type="checkbox"/>	Primary Display [IGD]	50
<input type="checkbox"/>	DVMT Pre-Allocated [256M]	50
<input type="checkbox"/>	DVMT Total Gfx Mem [MAX]	50
<input type="checkbox"/>	Primary IGFX Boot Display [Auto]	51
<input type="checkbox"/>	HD-Audio Support [Enable]	53
<input type="checkbox"/>	M2_KEYA1 [Enable]	54

IDS-310AI Embedded System

<input type="checkbox"/>	PCIe Speed [Auto].....	54
<input type="checkbox"/>	MPCIE1 [Enable]	55
<input type="checkbox"/>	PCIe Speed [Auto].....	55
<input type="checkbox"/>	SATA Controller [Enable].....	56
<input type="checkbox"/>	SATA Mode Selection [AHCI].....	56
<input type="checkbox"/>	Hot Plug [Disabled].....	57
<input type="checkbox"/>	Administrator Password	57
<input type="checkbox"/>	User Password	57
<input type="checkbox"/>	Bootup NumLock State [On].....	58
<input type="checkbox"/>	Quiet Boot [Enabled]	59
<input type="checkbox"/>	Launch PXE OpROM [Disabled].....	59
<input type="checkbox"/>	Option ROM Messages [Force BIOS].....	59
<input type="checkbox"/>	UEFI Boot [Disabled]	59
<input type="checkbox"/>	Boot Option Priority.....	59
<input type="checkbox"/>	Save Changes and Reset	60
<input type="checkbox"/>	Discard Changes and Reset	60
<input type="checkbox"/>	Restore Defaults	60
<input type="checkbox"/>	Save as User Defaults	61
<input type="checkbox"/>	Restore User Defaults	61

Appendix

D

Watchdog Timer

IDS-310AI Embedded System

**NOTE:**

The following discussion applies to DOS environment. IEI support is contacted or the IEI website visited for specific drivers for more sophisticated operating systems, e.g., Windows and Linux.

The Watchdog Timer is provided to ensure that standalone systems can always recover from catastrophic conditions that cause the CPU to crash. This condition may have occurred by external EMI or a software bug. When the CPU stops working correctly, Watchdog Timer either performs a hardware reset (cold boot) or a Non-Maskable Interrupt (NMI) to bring the system back to a known state.

A BIOS function call (INT 15H) is used to control the Watchdog Timer:

INT 15H:

AH – 6FH Sub-function:	
AL – 2:	Sets the Watchdog Timer's period.
BL:	Time-out value (Its unit-second is dependent on the item "Watchdog Timer unit select" in CMOS setup).

Table D-1: AH-6FH Sub-function

Call sub-function 2 to set the time-out period of Watchdog Timer first. If the time-out value is not zero, the Watchdog Timer starts counting down. While the timer value reaches zero, the system resets. To ensure that this reset condition does not occur, calling sub-function 2 must periodically refresh the Watchdog Timer. However, the Watchdog timer is disabled if the time-out value is set to zero.

A tolerance of at least 10% must be maintained to avoid unknown routines within the operating system (DOS), such as disk I/O that can be very time-consuming.

**NOTE:**

When exiting a program it is necessary to disable the Watchdog Timer, otherwise the system resets.

Example program:

```
; INITIAL TIMER PERIOD COUNTER
;
W_LOOP:

    MOV     AX, 6F02H      ;setting the time-out value
    MOV     BL, 30         ;time-out value is 48 seconds
    INT     15H

;
; ADD THE APPLICATION PROGRAM HERE
;

    CMP     EXIT_AP, 1     ;is the application over?
    JNE     W_LOOP        ;No, restart the application

    MOV     AX, 6F02H     ;disable Watchdog Timer
    MOV     BL, 0         ;
    INT     15H

;
; EXIT ;
```

Appendix

E

Error Beep Code

E.1 PEI Beep Codes

Number of Beeps	Description
1	Memory not Installed
1	Memory was installed twice (InstallPeiMemory routine in PEI Core called twice)
2	Recovery started
3	DXE IPL was not found
3	DXE Core Firmware Volume was not found
4	Recovery failed
4	S3 Resume failed
7	Reset PPI is not available

E.2 DXE Beep Codes

Number of Beeps	Description
1	Invalid password
4	Some of the Architectural Protocols are not available
5	No Console Output Devices are found
5	No Console Input Devices are found
6	Flash update is failed
7	Reset protocol is not available
8	Platform PCI resource requirements cannot be met



NOTE:

If you have any question, please contact IEI for further assistance.

Appendix

F

Hazardous Materials Disclosure

F.1 RoHS II Directive (2015/863/EU)

The details provided in this appendix are to ensure that the product is compliant with the RoHS II Directive (2015/863/EU). The table below acknowledges the presences of small quantities of certain substances in the product, and is applicable to RoHS II Directive (2015/863/EU).

Please refer to the following table.

Part Name	Toxic or Hazardous Substances and Elements									
	Lead (Pb)	Mercury (Hg)	Cadmium (Cd)	Hexavalent Chromium (CR(VI))	Polybrominated Biphenyls (PBB)	Polybrominated Diphenyl Ethers (PBDE)	Bis(2-ethylhexyl) phthalate (DEHP)	Butyl benzyl phthalate (BBP)	Dibutyl phthalate (DBP)	Diisobutyl phthalate (DIBP)
Housing	O	O	O	O	O	O	O	O	O	O
Printed Circuit Board	O	O	O	O	O	O	O	O	O	O
Metal Fasteners	O	O	O	O	O	O	O	O	O	O
Cable Assembly	O	O	O	O	O	O	O	O	O	O
Fan Assembly	O	O	O	O	O	O	O	O	O	O
Power Supply Assemblies	O	O	O	O	O	O	O	O	O	O
Battery	O	O	O	O	O	O	O	O	O	O
<p>O: This toxic or hazardous substance is contained in all of the homogeneous materials for the part is below the limit requirement in Directive (EU) 2015/863.</p> <p>X: This toxic or hazardous substance is contained in at least one of the homogeneous materials for this part is above the limit requirement in Directive (EU) 2015/863.</p>										

IDS-310AI Embedded System

F.2 China RoHS

此附件旨在确保本产品符合中国 RoHS 标准。以下表格标示此产品中某有毒物质的含量符合中国 RoHS 标准规定的限量要求。

本产品上会附有“环境友好使用期限”的标签，此期限是估算这些物质“不会有泄漏或突变”的年限。本产品可能包含有较短的环境友好使用期限的可替换元件，像是电池或灯管，这些元件将会单独标示出来。

部件名称	有毒有害物质或元素					
	铅 (Pb)	汞 (Hg)	镉 (Cd)	六价铬 (CR(VI))	多溴联苯 (PBB)	多溴二苯醚 (PBDE)
壳体	○	○	○	○	○	○
印刷电路板	○	○	○	○	○	○
金属螺帽	○	○	○	○	○	○
电缆组装	○	○	○	○	○	○
风扇组装	○	○	○	○	○	○
电力供应组装	○	○	○	○	○	○
电池	○	○	○	○	○	○

○: 表示该有毒有害物质在该部件所有物质材料中的含量均在 SJ/T11364-2014 與 GB/T26572-2011 标准规定的限量要求以下。

X: 表示该有毒有害物质至少在该部件的某一均质材料中的含量超出 SJ/T11364-2014 與 GB/T26572-2011 标准规定的限量要求。