

**MODEL:  
IMBA-C2260-i2**

**ATX Motherboard Supports LGA1150 Intel® Xeon® E3, Core™ i3, Pentium® or Celeron® CPU, Intel® C226 Chipset, DDR3, VGA, iDP, Dual Intel® PCIe GbE, Six SATA 6Gb/s, Four USB 3.0, HD Audio, iRIS-2400 and RoHS**

# User Manual

# Revision

---

| Date              | Version | Changes   |
|-------------------|---------|---|
| February 25, 2015 | 1.11    | Modified <b>Expansions</b> spec on page 7   |
| November 27, 2014 | 1.10    | Updated for R11 version<br>- Changed the PCIEX4_1 slot to a PCIe x4 slot<br>- Updated Chapter 5: BIOS |
| February 18, 2014 | 1.01    | Changed the PCIEX4_1 slot to a PCIe x1 slot   |
| January 14, 2014  | 1.00    | Initial release   |

# Copyright

---

## **COPYRIGHT NOTICE**

The information in this document is subject to change without prior notice in order to improve reliability, design and function and does not represent a commitment on the part of the manufacturer.

In no event will the manufacturer be liable for direct, indirect, special, incidental, or consequential damages arising out of the use or inability to use the product or documentation, even if advised of the possibility of such damages.

This document contains proprietary information protected by copyright. All rights are reserved. No part of this manual may be reproduced by any mechanical, electronic, or other means in any form without prior written permission of the manufacturer.

## **TRADEMARKS**

All registered trademarks and product names mentioned herein are used for identification purposes only and may be trademarks and/or registered trademarks of their respective owners.

# Table of Contents

|  |           |
|--|-----------|
| <b>1 INTRODUCTION.....</b>                     | <b>1</b>  |
| 1.1 INTRODUCTION.....                          | 2         |
| 1.2 FEATURES.....                              | 3         |
| 1.3 CONNECTORS .....                           | 4         |
| 1.4 DIMENSIONS.....                            | 5         |
| 1.5 DATA FLOW .....                            | 6         |
| 1.6 TECHNICAL SPECIFICATIONS .....             | 7         |
| <b>2 PACKING LIST.....</b>                     | <b>10</b> |
| 2.1 ANTI-STATIC PRECAUTIONS .....              | 11        |
| 2.2 UNPACKING PRECAUTIONS.....                 | 11        |
| 2.3 PACKING LIST.....                          | 12        |
| 2.4 OPTIONAL ITEMS .....                       | 13        |
| <b>3 CONNECTORS .....</b>                      | <b>15</b> |
| 3.1 PERIPHERAL INTERFACE CONNECTORS.....       | 16        |
| 3.1.1 IMBA-C2260-i2 Layout .....               | 16        |
| 3.1.2 Peripheral Interface Connectors .....    | 17        |
| 3.1.3 External Interface Panel Connectors..... | 18        |
| 3.2 INTERNAL PERIPHERAL CONNECTORS .....       | 19        |
| 3.2.1 +12V ATX Power Connector .....           | 19        |
| 3.2.2 Additional Power Connector .....         | 20        |
| 3.2.3 ATX Power Connector .....                | 20        |
| 3.2.4 Battery Connector.....                   | 22        |
| 3.2.5 Chassis Intrusion Connector.....         | 23        |
| 3.2.6 DDR3 DIMM Slots.....                     | 23        |
| 3.2.7 Digital I/O Connector.....               | 24        |
| 3.2.8 EC Debug Connector.....                  | 25        |
| 3.2.9 Fan Connector (CPU).....                 | 26        |
| 3.2.10 Fan Connectors (System).....            | 27        |
| 3.2.11 Front Panel Audio Connector .....       | 27        |

## IMBA-C2260-i2 ATX Motherboard

|  |           |
|--|-----------|
| 3.2.12 Front Panel Connector .....                             | 28        |
| 3.2.13 $\Psi$ C Connector .....                                | 29        |
| 3.2.14 Internal DisplayPort Connector .....                    | 30        |
| 3.2.15 iRIS Module Slot .....                                  | 31        |
| 3.2.16 Keyboard and Mouse Connector .....                      | 32        |
| 3.2.17 LAN LED Connectors .....                                | 33        |
| 3.2.18 mSATA Card Slot.....                                    | 34        |
| 3.2.19 Parallel Port Connector .....                           | 36        |
| 3.2.20 PCI Slots .....   | 37        |
| 3.2.21 PCIe x1 Slot .....                                      | 38        |
| 3.2.22 PCIe x4 Slots.....                                      | 38        |
| 3.2.23 PCI Express x16 Slot.....                               | 39        |
| 3.2.24 Power Button .....                                      | 40        |
| 3.2.25 SATA 6Gb/s Drive Connector .....                        | 41        |
| 3.2.26 Serial Port Connector, RS-232.....                      | 42        |
| 3.2.27 Serial Port Connector, RS-422/485.....                  | 43        |
| 3.2.28 SMBus Connector .....                                   | 44        |
| 3.2.29 SPI Flash Connector.....                                | 45        |
| 3.2.30 SPI Flash Connector, EC .....                           | 46        |
| 3.2.31 TPM Connector.....                                      | 47        |
| 3.2.32 USB 2.0 Connectors.....                                 | 48        |
| <b>3.3 EXTERNAL PERIPHERAL INTERFACE CONNECTOR PANEL .....</b> | <b>49</b> |
| 3.3.1 Audio Connector .....                                    | 49        |
| 3.3.2 Ethernet and USB 3.0 Connectors .....                    | 50        |
| 3.3.3 Keyboard/Mouse and USB 2.0 Connectors .....              | 51        |
| 3.3.4 Serial Port and VGA Connector .....                      | 52        |
| 3.3.5 USB 2.0 Connectors.....                                  | 53        |
| <b>4 INSTALLATION .....</b>                                    | <b>54</b> |
| 4.1 ANTI-STATIC PRECAUTIONS .....                              | 55        |
| 4.2 INSTALLATION CONSIDERATIONS.....                           | 55        |
| 4.2.1 Socket LGA1150 CPU Installation .....                    | 57        |
| 4.2.2 Socket LGA1150 Cooling Kit Installation.....             | 60        |
| 4.2.3 DIMM Installation .....                                  | 62        |
| 4.3 IRIS MODULE INSTALLATION.....                              | 63        |

|  |           |
|--|-----------|
| 4.4 mSATA CARD INSTALLATION.....                         | 64        |
| 4.5 SYSTEM CONFIGURATION.....                            | 66        |
| 4.5.1 AT/ATX Power Mode Setting .....                    | 66        |
| 4.5.2 Clear CMOS Button.....                             | 66        |
| 4.5.3 Flash Descriptor Security Override.....            | 67        |
| 4.5.4 mSATA Slot Setup.....                              | 68        |
| 4.5.5 PCIe x16 Interface Setup .....                     | 68        |
| 4.5.6 USB Power Selection .....                          | 69        |
| 4.6 INTERNAL PERIPHERAL DEVICE CONNECTIONS.....          | 70        |
| 4.6.1 SATA Drive Connection .....                        | 70        |
| 4.7 INTEL® AMT SETUP PROCEDURE.....                      | 71        |
| 4.8 IPMI SETUP PROCEDURE .....                           | 72        |
| 4.8.1 Managed System Hardware Setup .....                | 72        |
| 4.8.2 Using the IEI iMAN Web GUI.....                    | 72        |
| <b>5 BIOS.....</b>                                       | <b>75</b> |
| 5.1 INTRODUCTION.....                                    | 76        |
| 5.1.1 Starting Setup.....                                | 76        |
| 5.1.2 Using Setup .....                                  | 76        |
| 5.1.3 Getting Help.....                                  | 77        |
| 5.1.4 Unable to Reboot after Configuration Changes ..... | 77        |
| 5.1.5 BIOS Menu Bar.....                                 | 77        |
| 5.2 MAIN.....  | 79        |
| 5.3 ADVANCED.....  | 80        |
| 5.3.1 ACPI Settings .....                                | 81        |
| 5.3.2 RTC Wake Settings .....                            | 82        |
| 5.3.3 Trusted Computing .....                            | 83        |
| 5.3.4 CPU Configuration .....                            | 84        |
| 5.3.5 SATA Configuration.....                            | 86        |
| 5.3.6 Intel(R) Rapid Start Technology.....               | 87        |
| 5.3.7 AMT Configuration .....                            | 88        |
| 5.3.8 USB Configuration.....                             | 89        |
| 5.3.9 F81866 Super IO Configuration .....                | 90        |
| 5.3.9.1 Serial Port n Configuration .....                | 91        |
| 5.3.9.2 Parallel Port Configuration .....                | 96        |

## IMBA-C2260-i2 ATX Motherboard

|          |  |            |
|----------|--|------------|
| 5.3.10   | <i>iWDD H/W Monitor</i> .....                | 98         |
| 5.3.10.1 | Smart Fan Mode Configuration .....           | 99         |
| 5.3.11   | <i>Serial Port Console Redirection</i> ..... | 101        |
| 5.3.12   | <i>iEi Feature</i> .....                     | 104        |
| 5.4      | CHIPSET .....                                | 105        |
| 5.4.1    | <i>PCH-IO Configuration</i> .....            | 106        |
| 5.4.1.1  | PCI Express Configuration .....              | 108        |
| 5.4.1.2  | PCH Azalia Configuration .....               | 110        |
| 5.4.2    | <i>System Agent (SA) Configuration</i> ..... | 111        |
| 5.4.2.1  | Graphics Configuration .....                 | 111        |
| 5.4.2.2  | NB PCIe Configuration .....                  | 114        |
| 5.4.2.3  | Memory Configuration .....                   | 116        |
| 5.5      | BOOT .....                                   | 116        |
| 5.6      | SECURITY .....                               | 118        |
| 5.7      | SAVE & EXIT .....                            | 119        |
| 5.8      | SERVER MGMT .....                            | 120        |
| 5.8.1    | <i>System Event Log</i> .....                | 121        |
| 5.8.2    | <i>BMC Network Configuration</i> .....       | 123        |
| <b>6</b> | <b>SOFTWARE DRIVERS</b> .....                | <b>125</b> |
| 6.1      | AVAILABLE SOFTWARE DRIVERS .....             | 126        |
| 6.2      | SOFTWARE INSTALLATION .....                  | 126        |
| 6.3      | CHIPSET DRIVER INSTALLATION .....            | 128        |
| 6.4      | GRAPHICS DRIVER INSTALLATION .....           | 131        |
| 6.5      | LAN DRIVER INSTALLATION .....                | 134        |
| 6.6      | USB 3.0 DRIVER INSTALLATION .....            | 138        |
| 6.7      | AUDIO DRIVER INSTALLATION .....              | 141        |
| 6.8      | INTEL® AMT DRIVER INSTALLATION .....         | 143        |
| <b>A</b> | <b>BIOS OPTIONS</b> .....                    | <b>147</b> |
| <b>B</b> | <b>TERMINOLOGY</b> .....                     | <b>151</b> |
| <b>C</b> | <b>DIGITAL I/O INTERFACE</b> .....           | <b>155</b> |
| C.1      | INTRODUCTION .....                           | 156        |
| C.2      | ASSEMBLY LANGUAGE SAMPLE 1 .....             | 157        |
| C.3      | ASSEMBLY LANGUAGE SAMPLE 2 .....             | 157        |

|   |            |
|---|------------|
| <b>D WATCHDOG TIMER .....</b>   | <b>158</b> |
| <b>E INTEL® MATRIX STORAGE MANAGER .....</b>  | <b>161</b> |
| E.1 INTRODUCTION .....  | 162        |
| <i>E.1.1 Precautions</i> .....  | 162        |
| E.2 FEATURES AND BENEFITS.....  | 163        |
| E.3 ACCESSING THE INTEL® MATRIX STORAGE MANAGER .....   | 163        |
| E.4 INSTALLING THE OPERATING SYSTEM TO THE RAID ARRAY .....   | 164        |
| <b>F HAZARDOUS MATERIALS DISCLOSURE.....</b>  | <b>165</b> |
| F.1 HAZARDOUS MATERIALS DISCLOSURE TABLE FOR IPB PRODUCTS CERTIFIED AS<br>ROHS COMPLIANT UNDER 2002/95/EC WITHOUT MERCURY ..... | 166        |



# List of Figures

|  |    |
|--|----|
| Figure 1-1: IMBA-C2260-i2 .....                            | 2  |
| Figure 1-2: Connectors .....                               | 4  |
| Figure 1-3: IMBA-C2260-i2 Dimensions (mm).....             | 5  |
| Figure 1-4: Data Flow Diagram.....                         | 6  |
| Figure 3-1: Peripheral Interface Connectors .....          | 16 |
| Figure 3-2: +12V ATX Power Connector Pinout Location ..... | 19 |
| Figure 3-3: Additional Power Connector Location.....       | 20 |
| Figure 3-4: ATX Power Connector Location .....             | 21 |
| Figure 3-5: Battery Connector Location.....                | 22 |
| Figure 3-6: Chassis Intrusion Connector Location.....      | 23 |
| Figure 3-7: DDR3 DIMM Slot Locations .....                 | 24 |
| Figure 3-8: Digital I/O Connector Location .....           | 24 |
| Figure 3-9: EC Debug Connector Location .....              | 25 |
| Figure 3-10: CPU Fan Connector Location .....              | 26 |
| Figure 3-11: System Fan Connector Locations.....           | 27 |
| Figure 3-12: Front Panel Audio Connector Location .....    | 28 |
| Figure 3-13: Front Panel Connector Location .....          | 29 |
| Figure 3-14: I <sup>2</sup> C Connector Location .....     | 30 |
| Figure 3-15: Internal DisplayPort Connector Location ..... | 31 |
| Figure 3-16: iRIS Module Slot Location.....                | 32 |
| Figure 3-17: Keyboard and Mouse Connector Location.....    | 33 |
| Figure 3-18: LAN LED Connector Locations .....             | 34 |
| Figure 3-19: mSATA Card Slot Location .....                | 35 |
| Figure 3-20: Parallel Port Connector Location .....        | 36 |
| Figure 3-21: PCI Slot Locations .....                      | 37 |
| Figure 3-22: PCIe x1 Slot Location .....                   | 38 |
| Figure 3-23: PCIe x4 Slot Locations .....                  | 39 |
| Figure 3-24: PCIe x16 Slot Location .....                  | 40 |
| Figure 3-25: Power Button Location.....                    | 40 |
| Figure 3-26: SATA 6Gb/s Drive Connector Location .....     | 41 |

|   |     |
|---|-----|
| Figure 3-27: RS-232 Serial Port Connector Location.....               | 42  |
| Figure 3-28: RS-422/485 Connector Location.....                       | 44  |
| Figure 3-29: SMBus Connector Location.....                            | 45  |
| Figure 3-30: SPI Flash Connector Location.....                        | 45  |
| Figure 3-31: SPI EC Flash Connector Location.....                     | 46  |
| Figure 3-32: TPM Connector Location.....                              | 47  |
| Figure 3-33: USB 2.0 Connector Pinout Locations .....                 | 48  |
| Figure 3-34: External Peripheral Interface Connector .....            | 49  |
| Figure 3-35: Audio Connector .....                                    | 50  |
| Figure 3-36: Serial Port Connector Pinouts.....                       | 52  |
| Figure 3-37: VGA Connector .....                                      | 53  |
| Figure 4-1: Disengage the CPU Socket Load Lever.....                  | 57  |
| Figure 4-2: Remove Protective Cover.....                              | 58  |
| Figure 4-3: Insert the Socket LGA1150 CPU.....                        | 59  |
| Figure 4-4: Close the Socket LGA1150 .....                            | 59  |
| Figure 4-5: Cooling Kit Support Bracket.....                          | 61  |
| Figure 4-6: DIMM Installation.....                                    | 62  |
| Figure 4-7: iRIS Module Installation.....                             | 63  |
| Figure 4-8: Remove the Retention Screws for the mSATA Card.....       | 64  |
| Figure 4-9: Insert the mSATA Card into the Socket at an Angle .....   | 65  |
| Figure 4-10: Secure the mSATA Card.....                               | 65  |
| Figure 4-11: AT/ATX Power Mode Switch Location .....                  | 66  |
| Figure 4-12: Clear CMOS Button Location.....                          | 67  |
| Figure 4-13: Flash Descriptor Security Override Jumper Location ..... | 67  |
| Figure 4-14: mSATA Slot Setup Jumper Location .....                   | 68  |
| Figure 4-15: SATA Drive Cable Connection.....                         | 70  |
| Figure 4-16: SATA Power Drive Connection.....                         | 71  |
| Figure 4-17: IEI iMAN Web Address.....                                | 73  |
| Figure 4-18: IEI iMAN Web GUI.....                                    | 74  |
| Figure 6-1: Introduction Screen .....                                 | 127 |
| Figure 6-2: Available Drivers .....                                   | 127 |
| Figure 6-3: Chipset Driver Welcome Screen.....                        | 128 |
| Figure 6-4: Chipset Driver License Agreement .....                    | 129 |
| Figure 6-5: Chipset Driver Read Me File .....                         | 129 |
| Figure 6-6: Chipset Driver Setup Operations .....                     | 130 |

## IMBA-C2260-i2 ATX Motherboard

|  |     |
|--|-----|
| Figure 6-7: Chipset Driver Installation Finish Screen.....     | 130 |
| Figure 6-8: Graphics Driver Welcome Screen .....               | 131 |
| Figure 6-9: Graphics Driver License Agreement.....             | 132 |
| Figure 6-10: Graphics Driver Read Me File .....                | 132 |
| Figure 6-11: Graphics Driver Setup Operations .....            | 133 |
| Figure 6-12: Graphics Driver Installation Finish Screen .....  | 133 |
| Figure 6-13: Intel® Network Connection Menu.....               | 134 |
| Figure 6-14: LAN Driver Welcome Screen .....                   | 135 |
| Figure 6-15: LAN Driver License Agreement.....                 | 135 |
| Figure 6-16: LAN Driver Setup Options.....                     | 136 |
| Figure 6-17: LAN Driver Installation .....                     | 137 |
| Figure 6-18: LAN Driver Installation Complete.....             | 137 |
| Figure 6-19: USB 3.0 Driver Welcome Screen .....               | 138 |
| Figure 6-20: USB 3.0 Driver License Agreement.....             | 139 |
| Figure 6-21: USB 3.0 Driver Read Me File .....                 | 139 |
| Figure 6-22: USB 3.0 Driver Setup Operations .....             | 140 |
| Figure 6-23: USB 3.0 Driver Installation Finish Screen .....   | 141 |
| Figure 6-24: InstallShield Wizard Welcome Screen .....         | 142 |
| Figure 6-25: Audio Driver Software Configuration.....          | 142 |
| Figure 6-26: Restart the Computer .....                        | 143 |
| Figure 6-27: Intel® ME Driver Welcome Screen .....             | 144 |
| Figure 6-28: Intel® ME Driver License Agreement.....           | 145 |
| Figure 6-29: Intel® ME Driver Setup Operations .....           | 145 |
| Figure 6-30: Intel® ME Driver Installation Finish Screen ..... | 146 |

# List of Tables

---

|  |    |
|--|----|
| Table 1-1: IMBA-C2260-i2 Specifications .....            | 9  |
| Table 2-1: Packing List.....                             | 12 |
| Table 2-2: Optional Items .....                          | 14 |
| Table 3-1: Peripheral Interface Connectors .....         | 18 |
| Table 3-2: Rear Panel Connectors .....                   | 19 |
| Table 3-3: +12V ATX Power Connector Pinouts .....        | 19 |
| Table 3-4: Additional Power Connector Pinouts .....      | 20 |
| Table 3-5: ATX Power Connector Pinouts .....             | 21 |
| Table 3-6: Chassis Intrusion Connector Pinouts .....     | 23 |
| Table 3-7: Digital I/O Connector Pinouts.....            | 25 |
| Table 3-8: EC Debug Connector Pinouts .....              | 26 |
| Table 3-9: CPU Fan Connector Pinouts.....                | 26 |
| Table 3-10: System Fan Connector Pinouts .....           | 27 |
| Table 3-11: Front Panel Audio Connector Pinouts .....    | 28 |
| Table 3-12: Front Panel Connector Pinouts.....           | 29 |
| Table 3-13: I <sup>2</sup> C Connector Pinouts.....      | 30 |
| Table 3-14: Internal DisplayPort Connector Pinouts ..... | 31 |
| Table 3-15: Keyboard and Mouse Connector Pinouts .....   | 33 |
| Table 3-16: LAN1 LED Connector (LED_LAN1) Pinouts.....   | 34 |
| Table 3-17: LAN2 LED Connector (LED_LAN2) Pinouts.....   | 34 |
| Table 3-18: mSATA Card Slot Pinouts.....                 | 36 |
| Table 3-19: Parallel Port Connector Pinouts .....        | 37 |
| Table 3-20: SATA 6Gb/s Drive Connector Pinouts.....      | 41 |
| Table 3-21: RS-232 Serial Port Connector Pinouts .....   | 43 |
| Table 3-22: RS-422/485 Connector Pinouts .....           | 44 |
| Table 3-23: DB-9 RS-422/485 Pinouts .....                | 44 |
| Table 3-24: SMBus Connector Pinouts .....                | 45 |
| Table 3-25: SPI Flash Connector Pinouts .....            | 46 |
| Table 3-26: SPI EC Flash Connector Pinouts .....         | 46 |
| Table 3-27: TPM Connector Pinouts .....                  | 47 |

## IMBA-C2260-i2 ATX Motherboard

|  |     |
|--|-----|
| Table 3-28: USB 2.0 Connector Pinouts.....                         | 48  |
| Table 3-29: USB 3.0 Port Pinouts.....                              | 50  |
| Table 3-30: LAN Pinouts .....                                      | 51  |
| Table 3-31: USB 2.0 Port Pinouts.....                              | 51  |
| Table 3-32: PS/2 Connector Pinouts.....                            | 51  |
| Table 3-33: Serial Port Connector Pinouts .....                    | 52  |
| Table 3-34: VGA Connector Pinouts.....                             | 53  |
| Table 3-35: USB 2.0 Port Pinouts.....                              | 53  |
| Table 4-1: AT/ATX Power Mode Switch Settings.....                  | 66  |
| Table 4-2: Flash Descriptor Security Override Jumper Settings..... | 67  |
| Table 4-3: mSATA Slot Setup Jumper Settings.....                   | 68  |
| Table 4-4: PCIe x16 Interface Setup.....                           | 69  |
| Table 4-5: BIOS Options and Configured USB Ports.....              | 69  |
| Table 4-6: USB Power Source Setup .....                            | 69  |
| Table 5-1: BIOS Navigation Keys .....                              | 77  |
| Table 5-2: BIOS Options and Configured USB Ports.....              | 107 |

# BIOS Menus

---

|  |     |
|--|-----|
| BIOS Menu 1: Main .....  | 79  |
| BIOS Menu 2: Advanced .....  | 80  |
| BIOS Menu 3: ACPI Configuration .....                                  | 81  |
| BIOS Menu 4: RTC Wake Settings .....                                   | 82  |
| BIOS Menu 5: Trusted Computing .....                                   | 83  |
| BIOS Menu 6: CPU Configuration .....                                   | 84  |
| BIOS Menu 7: SATA Configuration .....                                  | 86  |
| BIOS Menu 8: Intel(R) Rapid Start Technology .....                     | 87  |
| BIOS Menu 9: AMT Configuration .....                                   | 88  |
| BIOS Menu 10: USB Configuration .....                                  | 89  |
| BIOS Menu 11: F81866 Super IO Configuration .....                      | 90  |
| BIOS Menu 12: Serial Port n Configuration Menu .....                   | 91  |
| BIOS Menu 13: Parallel Port Configuration Menu .....                   | 96  |
| BIOS Menu 14: iWDD H/W Monitor .....                                   | 98  |
| BIOS Menu 15: Smart Fan Mode Configuration .....                       | 99  |
| BIOS Menu 16: Serial Port Console Redirection .....                    | 101 |
| BIOS Menu 17: iEi Feature .....  | 104 |
| BIOS Menu 18: Chipset .....  | 105 |
| BIOS Menu 19: PCH-IO Configuration .....                               | 106 |
| BIOS Menu 20: PCI Express Configuration .....                          | 108 |
| BIOS Menu 21: PCIEX1_1 Slot and PCIEX4_1 Slot Configuration Menu ..... | 108 |
| BIOS Menu 22: PCH Azalia Configuration .....                           | 110 |
| BIOS Menu 23: System Agent (SA) Configuration .....                    | 111 |
| BIOS Menu 24: Graphics Configuration .....                             | 111 |
| BIOS Menu 25: LCD Control .....  | 113 |
| BIOS Menu 26: NB PCIe Configuration .....                              | 114 |
| BIOS Menu 27: Memory Configuration .....                               | 116 |
| BIOS Menu 28: Boot .....   | 116 |
| BIOS Menu 29: Security .....   | 118 |
| BIOS Menu 30: Save & Exit .....  | 119 |

## IMBA-C2260-i2 ATX Motherboard

|                                      |     |
|--------------------------------------|-----|
| BIOS Menu 31: Server Mgmt .....      | 120 |
| BIOS Menu 32: System Event Log ..... | 121 |
| BIOS Menu 33: System Event Log ..... | 123 |

Chapter

1

# Introduction

---



## 1.1 Introduction

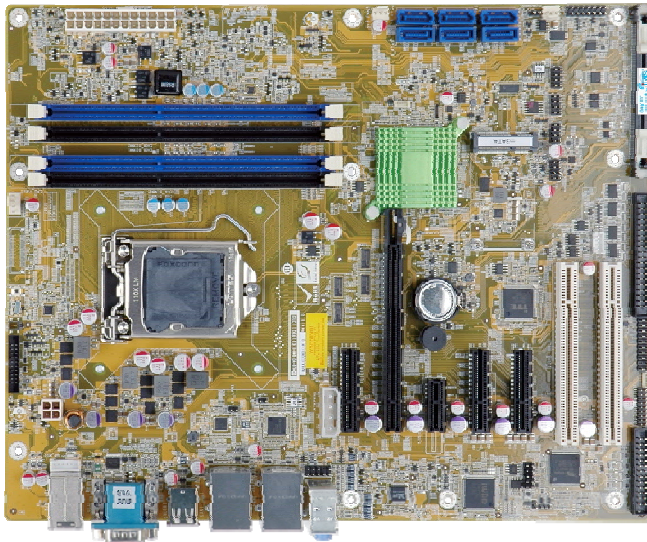

**Figure 1-1: IMBA-C2260-i2**

The IMBA-C2260-i2 is an ATX motherboard. It accepts a Socket LGA1150 Intel® Xeon® E3, Core™ i3, Pentium® or Celeron® processor and supports four 240-pin 1600/1333 MHz dual-channel DDR3 DIMM modules up to 32 GB.

The IMBA-C2260-i2 provides two GbE interfaces through the Intel® I217 (with Intel® AMT 9.0 support) and the Intel® I210 PCIe controllers. The integrated Intel® C226 chipset supports six SATA 6Gb/s drives. In addition, the IMBA-C2260-i2 includes VGA and iDP interfaces for dual independent display.

Expansion and I/O include two PCI slots, one PCIe x16 slot, three PCIe x4 slots, one PCIe x1 slot, four USB 3.0 and four USB 2.0 on the rear panel, four USB 2.0 by pin headers, six COM ports and one mSATA card slot. High Definition Audio (HDA) support ensures HDA devices can be easily implemented on the IMBA-C2260-i2.

## IMBA-C2260-i2 ATX Motherboard

### 1.2 Features

Some of the IMBA-C2260-i2 motherboard features are listed below:

- ATX form factor
- LGA1150 Intel® Xeon® E3, Core™ i3, Pentium® or Celeron® processor supported
- Intel® C226 chipset
- Four 240-pin 1600/1333 MHz dual-channel DDR3 DIMMs support up to 32 GB
- Two Intel® PCIe GbE connectors (LAN1 with Intel® AMT 9.0 support)
- Supports PCI Express Generation 3.0 at 8 GT/s I/O bandwidth
- Dual independent display by VGA and iDP interfaces
- Supports IPMI 2.0 via iRIS-2400 module
- Six SATA 6Gb/s connectors support RAID 0, 1, 5, 10
- Four USB 3.0 ports on the rear panel
- One mSATA card slot
- One PCIe x16 slot
- Three PCIe x4 slots
- One PCIe x1 slot
- Two PCI slots
- Six COM ports
- TPM V1.2 hardware security function supported by TPM module
- High Definition Audio
- RoHS compliant

### 1.3 Connectors

The connectors on the IMBA-C2260-i2 are shown in the figure below.

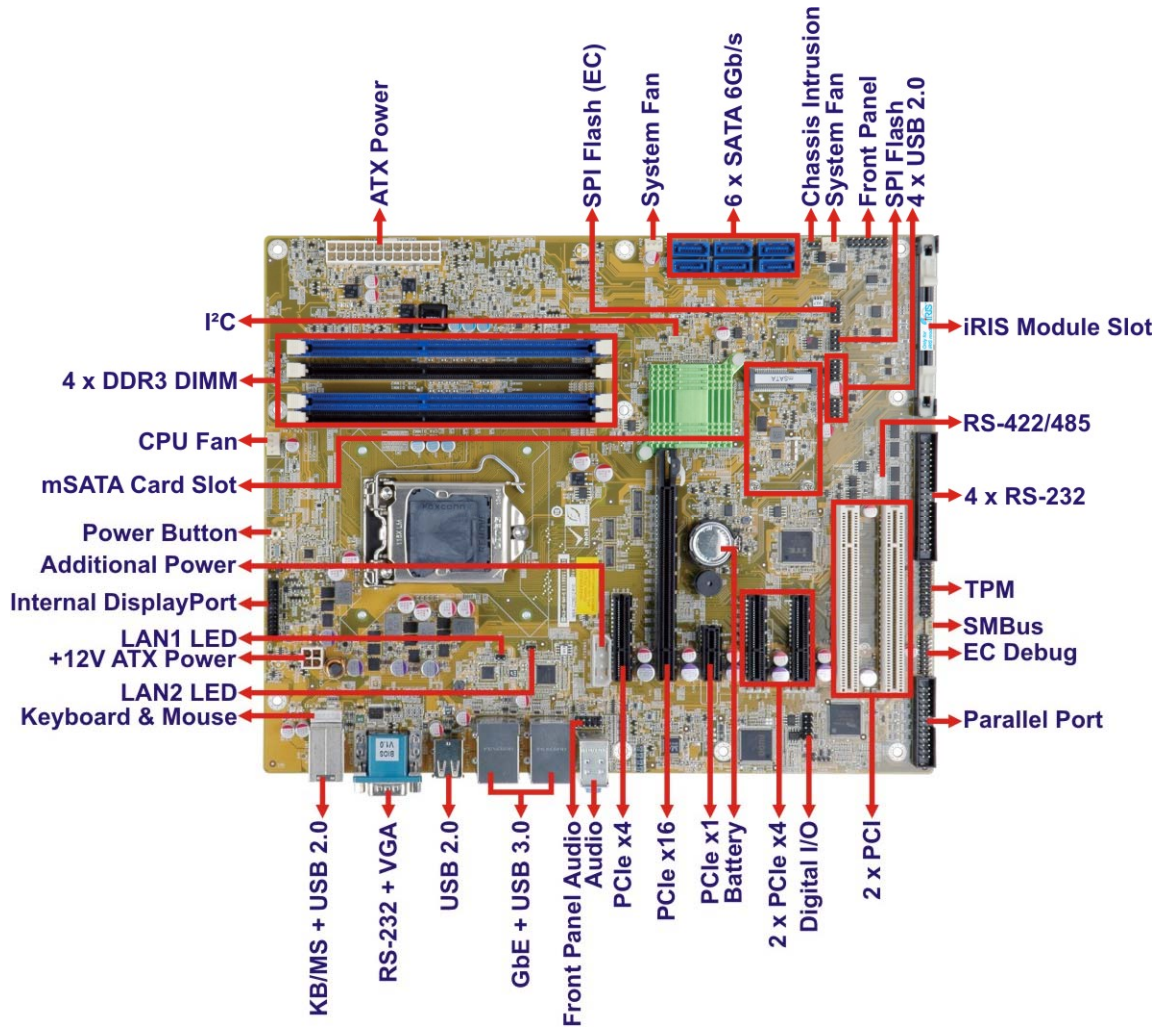
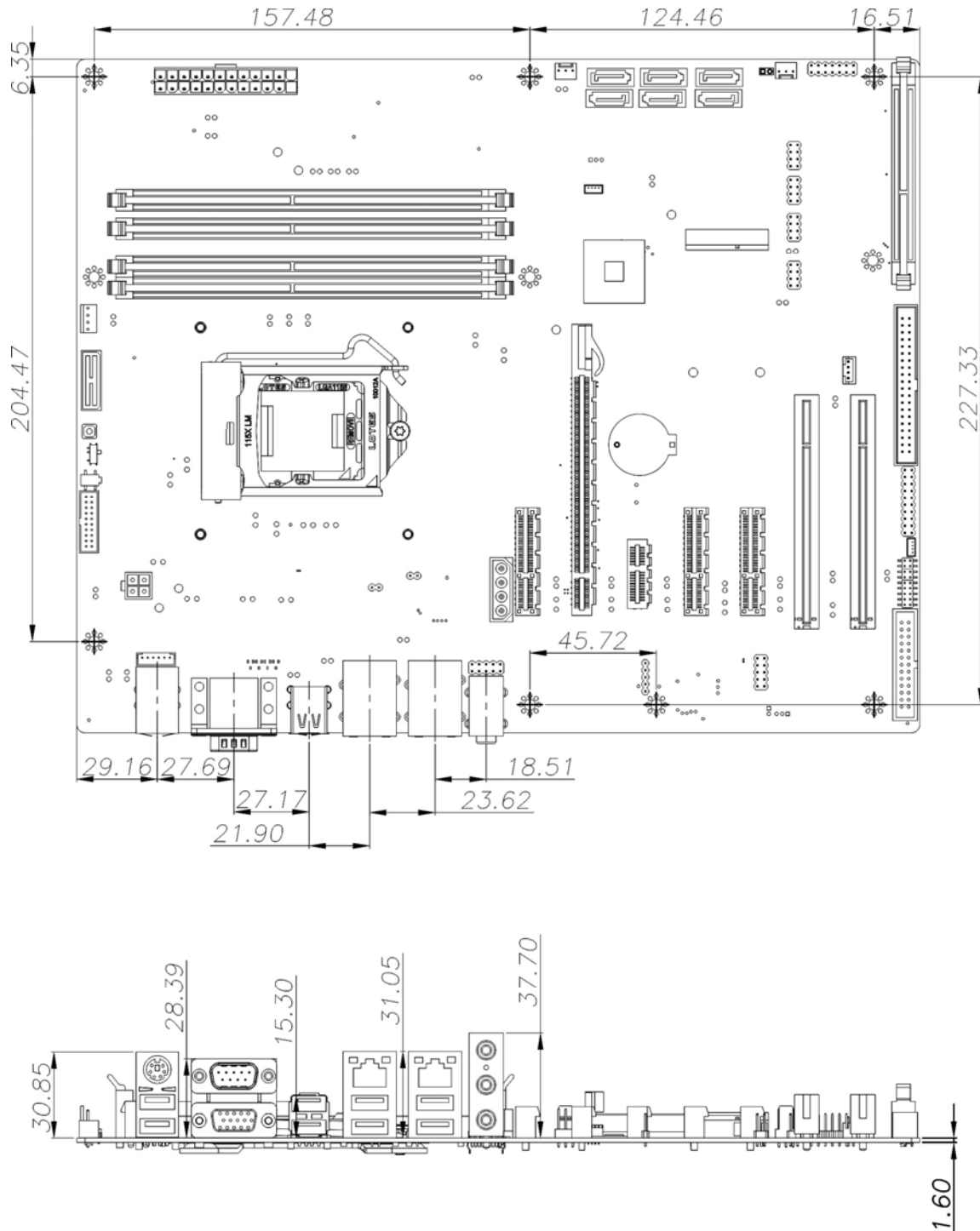

Figure 1-2: Connectors

**IMBA-C2260-i2 ATX Motherboard**

**1.4 Dimensions**

The main dimensions of the IMBA-C2260-i2 are shown in the diagram below.



**Figure 1-3: IMBA-C2260-i2 Dimensions (mm)**

### 1.5 Data Flow

Figure 1-4 shows the data flow between the system chipset, the CPU and other components installed on the motherboard.

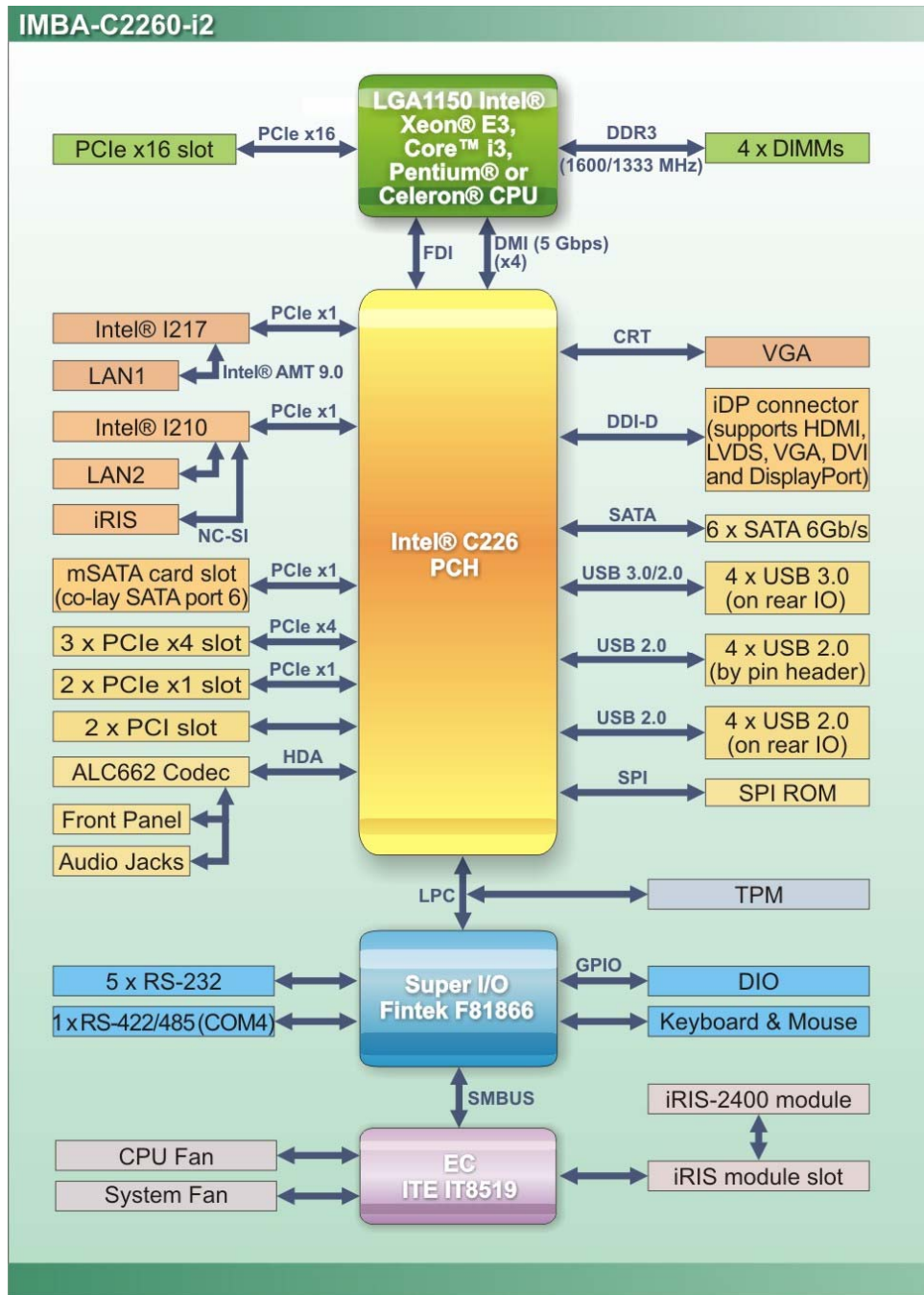

Figure 1-4: Data Flow Diagram

## IMBA-C2260-i2 ATX Motherboard

### 1.6 Technical Specifications

The IMBA-C2260-i2 technical specifications are listed below.

| Specification/Model             | IMBA-C2260-i2  |
|---------------------------------|--|
| <b>Form Factor</b>              | ATX  |
| <b>CPU Supported</b>            | LGA1150 Intel® Xeon® E3, Core™ i3, Pentium® or Celeron® CPU  |
| <b>Chipset</b>                  | Intel® C226  |
| <b>Memory</b>                   | Four 240-pin 1600/1333 MHz dual-channel ECC/non-ECC unbuffered DDR3 SDRAM DIMMs support (system max. 32 GB)  |
| <b>Graphics Engine</b>          | Intel® HD Graphics Gen 7.5 supports DirectX 11.1, OpenCL 1.2 and OpenGL 3.2<br>Full MPEG2, VC1, AVC Decode   |
| <b>Audio</b>                    | Realtek ALC662 HD Audio codec (line-in, line-out, mic-in)  |
| <b>BIOS</b>                     | UEFI BIOS  |
| <b>Ethernet Controllers</b>     | <b>LAN1:</b> Intel® I217 PHY with Intel® AMT 9.0 support (LAN1_USB1)<br><b>LAN2:</b> Intel® I210 PCIe Ethernet controller (LAN1_USB2)  |
| <b>Super I/O Controller</b>     | Fintek F81866  |
| <b>Watchdog Timer</b>           | Software programmable supports 1~255 sec. system reset   |
| <b>Expansions</b>               | One mSATA card slot (co-lay SATA port 6)<br>Two PCI slots<br>One PCIe x1 slot<br>One PCIe x4 slot (PCIEX4_1)<br>One PCIe x16 slot*<br>Two PCIe x4 slots (PCIEX4_2 and PCIEX4_3)*<br>* Default setting: One PCIe x8 Gen 3 + Two PCIe x4 Gen 3 signal<br>Operation setting: One PCIe x16 by BIOS setting |
| <b>I/O Interface Connectors</b> |  |
| <b>Audio Connectors</b>         | Line-in, line-out and mic-in audio jacks on rear panel<br>One internal front panel audio connector (10-pin header)   |

|   |   |
|---|---|
| <b>Specification/Model</b>                    | <b>IMBA-C2260-i2</b>  |
| <b>Chassis Intrusion</b>                      | One 2-pin header  |
| <b>Digital I/O</b>                            | 8-bit, 4-bit input/4-bit output   |
| <b>Display Output</b>                         | One VGA (up to 1920 x 1200, 60 Hz)<br>One iDP interface for HDMI, LVDS, VGA, DVI and DisplayPort (up to 3840 x 2160, 60 Hz) |
| <b>Ethernet</b>                               | Two RJ-45 GbE ports   |
| <b>Fan</b>                                    | One 4-pin CPU fan connector<br>One 3-pin system fan connector   |
| <b>Front Panel</b>                            | One 14-pin header (power LED, HDD LED, IPMI LED, speaker, power button, reset button)                                       |
| <b>I<sup>2</sup>C</b>                         | One 4-pin wafer connector   |
| <b>IPMI 2.0</b>                               | One iRIS module slot  |
| <b>Keyboard and Mouse</b>                     | One PS/2 keyboard/mouse connector<br>One internal keyboard and mouse connector (6-pin wafer)                                |
| <b>LAN LED</b>                                | Two 2-pin headers for LAN1 LED and LAN2 LED   |
| <b>Parallel Port</b>                          | One parallel port via internal 26-pin box header  |
| <b>Serial ATA</b>                             | Six SATA 6Gb/s connectors (support RAID 0, 1, 5, 10)  |
| <b>Serial Ports</b>                           | One external RS-232 serial port<br>Four RS-232 via internal box header<br>One RS-422/485 via internal 4-pin wafer connector |
| <b>SMBus</b>                                  | One 4-pin wafer connector   |
| <b>TPM</b>                                    | One via 20-pin header   |
| <b>USB Ports</b>                              | Four USB 3.0 ports on rear panel<br>Four USB 2.0 ports on rear panel<br>Four internal USB 2.0 ports by pin headers          |
| <b>Environmental and Power Specifications</b> |   |
| <b>Power Supply</b>                           | ATX power supply  |

## IMBA-C2260-i2 ATX Motherboard

|                                |  |
|--------------------------------|--|
| <b>Specification/Model</b>     | <b>IMBA-C2260-i2</b>   |
| <b>Power Consumption</b>       | 3.3V@0.57A, 5V@4.50A, 12V@0.14A, Vcore@5.20A, 5VSB@0.19A<br>(3.1 GHz Intel® CPU with four 2 GB 1333 MHz DDR3 memory) |
| <b>Operating Temperature</b>   | -20°C ~ 60°C   |
| <b>Storage Temperature</b>     | -30°C ~ 70°C   |
| <b>Humidity</b>                | 5% ~ 95% (non-condensing)  |
| <b>Physical Specifications</b> |  |
| <b>Dimensions</b>              | 244 mm x 305 mm  |
| <b>Weight (GW/NW)</b>          | 1200 g/700 g   |

**Table 1-1: IMBA-C2260-i2 Specifications**



Chapter

2

# Packing List

---

## IMBA-C2260-i2 ATX Motherboard

### 2.1 Anti-static Precautions

---



#### WARNING!

Static electricity can destroy certain electronics. Make sure to follow the ESD precautions to prevent damage to the product, and injury to the user.

---

Make sure to adhere to the following guidelines:

- **Wear an anti-static wristband:** Wearing an anti-static wristband can prevent electrostatic discharge.
- **Self-grounding:** Touch a grounded conductor every few minutes to discharge any excess static buildup.
- **Use an anti-static pad:** When configuring any circuit board, place it on an anti-static mat.
- **Only handle the edges of the PCB:** Don't touch the surface of the motherboard. Hold the motherboard by the edges when handling.

### 2.2 Unpacking Precautions

When the IMBA-C2260-i2 is unpacked, please do the following:

- Follow the anti-static guidelines above.
- Make sure the packing box is facing upwards when opening.
- Make sure all the packing list items are present.







## 2.3 Packing List

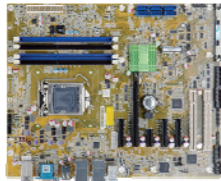

**NOTE:**

If any of the components listed in the checklist below are missing, do not proceed with the installation. Contact the IEI reseller or vendor the IMBA-C2260-i2 was purchased from or contact an IEI sales representative directly by sending an email to [sales@ieiworld.com](mailto:sales@ieiworld.com).

The IMBA-C2260-i2 is shipped with the following components:

| Quantity | Item and Part Number                       | Image   |
|----------|--|---|
| 1        | IMBA-C2260-i2 single board computer        |   |
| 2        | SATA cable<br>(P/N: 32000-062800-RS)       |  |
| 1        | I/O shielding<br>(P/N: 45014-0045C0-00-RS) |  |
| 1        | Utility CD                                 |  |
| 1        | One Key Recovery CD                        |  |
| 1        | Quick Installation Guide                   |  |







**Table 2-1: Packing List**

## IMBA-C2260-i2 ATX Motherboard

### 2.4 Optional Items

The following are optional components which may be separately purchased:

| Item and Part Number  | Image   |
|---|---|
| iRIS-2400 module, IPMI 2.0 adapter card with AST2400 BMC chip for DDR3 SO-DIMM socket interface<br>(P/N: iRIS-2400-R10) |    |
| Dual-port USB cable with bracket<br>(P/N: 19800-003100-300-RS)  |    |
| RS-422/485 cable, 200 mm<br>(P/N: 32205-003800-300-RS)  |    |
| RS-232 cable, 40-pin to four DB-9<br>(P/N: 32205-001203-200-RS)   |   |
| PS/2 KB/MS Y-cable with bracket<br>(P/N: 19800-000075-RS)   |  |
| SATA power cable<br>(P/N: 32102-000100-200-RS)  |  |
| LPT cable<br>(P/N: 19800-000049-RS)   |  |
| LGA1155/LGA1156 cooler kit (1U chassis compatible, 73W)<br>(P/N: CF-1156A-RS-R11)                                       |  |

| Item and Part Number  | Image   |
|---|---|
| LGA1155/LGA1156 cooler kit (95W)<br><b>(P/N: CF-1156E-R11)</b>  |    |
| DisplayPort to HDMI converter board for IEI IDP connector<br><b>(P/N: DP-HDMI-R10)</b>                |    |
| DisplayPort to LVDS converter board for IEI IDP connector<br><b>(P/N: DP-LVDS-R10)</b>                |    |
| DisplayPort to VGA converter board for IEI IDP connector<br><b>(P/N: DP-VGA-R10)</b>                  |   |
| DisplayPort to DVI-D converter board for IEI IDP connector<br><b>(P/N: DP-DVI-R10)</b>                |  |
| DisplayPort to DisplayPort converter board for IEI iDP connector<br><b>(P/N: DP-DP-R10)</b>           |  |
| 20-pin Infineon TPM module, software management tool,<br>firmware v3.17<br><b>(P/N: TPM-IN01-R11)</b> |  |

**Table 2-2: Optional Items**

Chapter

**3**

# Connectors

---

### 3.1 Peripheral Interface Connectors

This chapter details all the peripheral interface connectors.

#### 3.1.1 IMBA-C2260-i2 Layout

The figures below show all the peripheral interface connectors.

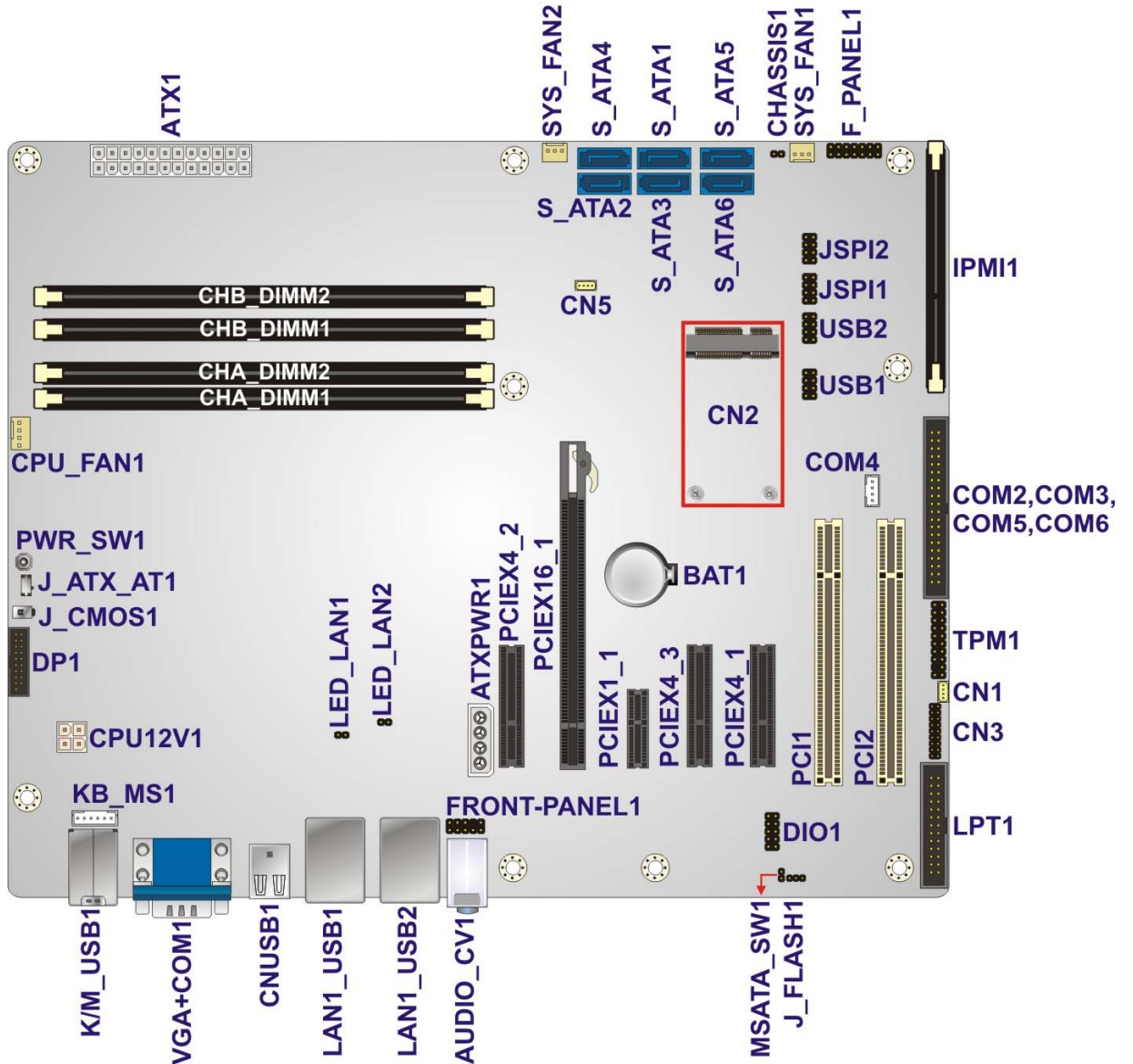

Figure 3-1: Peripheral Interface Connectors

## IMBA-C2260-i2 ATX Motherboard

### 3.1.2 Peripheral Interface Connectors

The table below lists all the connectors on the board.

| Connector                      | Type                        | Label   |
|--------------------------------|-----------------------------|---|
| +12V ATX power connector       | 4-pin Molex power connector | CPU12V1   |
| Additional power connector     | 4-pin connector             | ATXPWR1   |
| ATX power connector            | 24-pin connector            | ATX1  |
| Battery connector              | Battery holder              | BAT1  |
| Chassis intrusion connector    | 2-pin header                | CHASSIS1  |
| DDR3 DIMM sockets              | 240-pin socket              | CHA_DIMM1,<br>CHA_DIMM2,<br>CHB_DIMM1,<br>CHB_DIMM2 |
| Digital I/O connector          | 10-pin header               | DIO1  |
| EC debug connector             | 18-pin header               | CN3   |
| Fan connector (CPU)            | 4-pin wafer                 | CPU_FAN1  |
| Fan connectors (system)        | 3-pin wafer                 | SYS_FAN1,<br>SYS_FAN2                               |
| Front panel audio connector    | 10-pin header               | FRONT-PANEL1  |
| Front panel connector          | 14-pin header               | F_PANEL1  |
| I <sup>2</sup> C connector     | 4-pin wafer                 | CN5   |
| Internal DisplayPort connector | 19-pin box header           | DP1   |
| iRIS module slot               | iRIS module slot            | IPMI1   |
| Keyboard and mouse connector   | 6-pin wafer                 | KB_MS1  |
| LAN1 LED connector             | 2-pin header                | LED_LAN1  |
| LAN2 LED connector             | 2-pin header                | LED_LAN2  |
| mSATA card slot                | PCIe Mini slot              | CN2   |
| Parallel port connector        | 26-pin box header           | LPT1  |



| Connector                  | Type                 | Label  |
|----------------------------|----------------------|--|
| PCI slots                  | PCI slot             | PCI1, PCI2   |
| PCIe x1 slot               | PCIe x1 slot         | PCIEX1_1   |
| PCIe x4 slots              | PCIe x4 slot         | PCIEX4_1,<br>PCIEX4_2,<br>PCIEX4_3                   |
| PCIe x16 slot              | PCIe x16 slot        | PCIEX16_1  |
| Power button               | Push button          | PWR_SW1  |
| SATA 6Gb/s drive connector | 7-pin SATA connector | S_ATA1, S_ATA2,<br>S_ATA3, S_ATA4,<br>S_ATA5, S_ATA6 |
| Serial port, RS-232        | 40-pin box header    | COM2,COM3,<br>COM5,COM6                              |
| Serial port, RS-422/485    | 4-pin wafer          | COM4   |
| SMBus connector            | 4-pin wafer          | CN1  |
| SPI flash connector        | 8-pin header         | JSPI1  |
| SPI flash connector, EC    | 8-pin header         | JSPI2  |
| TPM connector              | 20-pin header        | TPM1   |
| USB 2.0 connectors         | 8-pin header         | USB1, USB2   |

**Table 3-1: Peripheral Interface Connectors**

### 3.1.3 External Interface Panel Connectors

The table below lists the connectors on the external I/O panel.

| Connector                        | Type           | Label                   |
|----------------------------------|----------------|-------------------------|
| Audio connector                  | Audio jacks    | AUDIO_CV1               |
| Ethernet and USB 3.0 ports       | RJ-45, USB 3.0 | LAN1_USB1,<br>LAN1_USB2 |
| Keyboard/mouse and USB 2.0 ports | PS/2, USB 2.0  | K/M_USB1                |

## IMBA-C2260-i2 ATX Motherboard

| Connector                     | Type                              | Label   |
|-------------------------------|-----------------------------------|---------|
| Serial port and VGA connector | 9-pin male DB-9,<br>15-pin female | VGACOM1 |
| USB 2.0 ports                 | USB 2.0                           | CNUSB1  |

**Table 3-2: Rear Panel Connectors**

### 3.2 Internal Peripheral Connectors

The section describes all of the connectors on the IMBA-C2260-i2.

#### 3.2.1 +12V ATX Power Connector

- CN Label:** CPU12V1
- CN Type:** 4-pin Molex power connector
- CN Location:** See **Figure 3-2**
- CN Pinouts:** See **Table 3-3**

This connector provides power to the CPU.

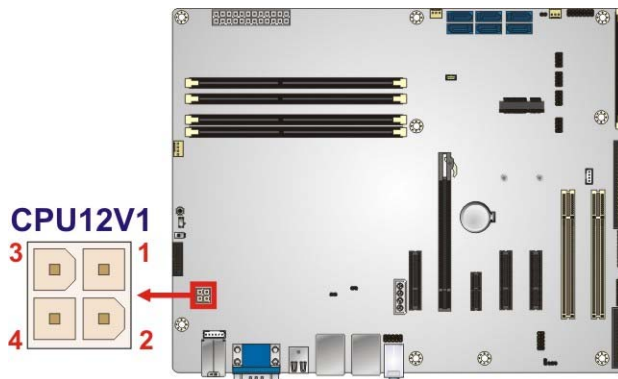

**Figure 3-2: +12V ATX Power Connector Pinout Location**

| Pin | Description | Pin | Description |
|-----|-------------|-----|-------------|
| 1   | GND         | 2   | GND         |
| 3   | +12V        | 4   | +12V        |

**Table 3-3: +12V ATX Power Connector Pinouts**

### 3.2.2 Additional Power Connector

- CN Label:** ATXPWR1
- CN Type:** 4-pin connector
- CN Location:** See **Figure 3-3**
- CN Pinouts:** See **Table 3-4**

The additional power connector provides extra +12V and +5V power to the system.

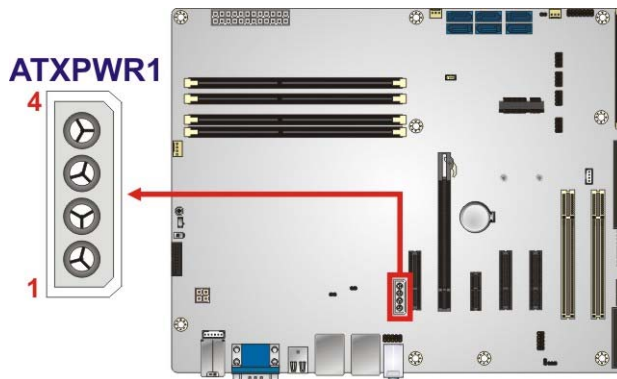

**Figure 3-3: Additional Power Connector Location**

| Pin | Description |
|-----|-------------|
| 1   | +12V        |
| 2   | GND         |
| 3   | GND         |
| 4   | VCC         |

**Table 3-4: Additional Power Connector Pinouts**

### 3.2.3 ATX Power Connector

- CN Label:** ATX1
- CN Type:** 24-pin connector
- CN Location:** See **Figure 3-4**
- CN Pinouts:** See **Table 3-5**

The ATX power connector connects to an ATX power supply.

IMBA-C2260-i2 ATX Motherboard

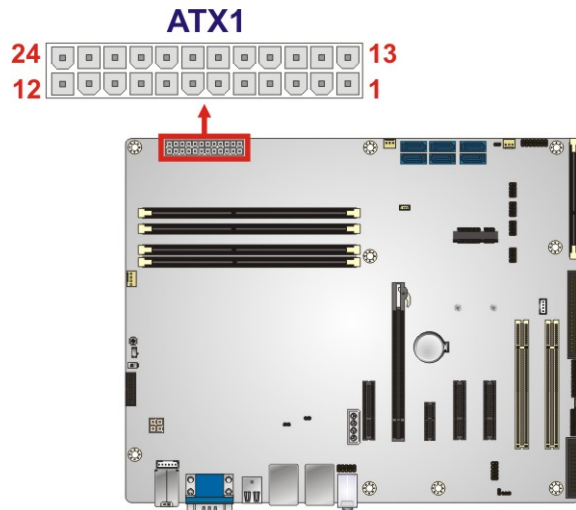

Figure 3-4: ATX Power Connector Location

| Pin | Description | Pin | Description |
|-----|-------------|-----|-------------|
| 1   | +3.3V       | 13  | +3.3V       |
| 2   | +3.3V       | 14  | -12V        |
| 3   | GND         | 15  | GND         |
| 4   | +5V         | 16  | PS_ON       |
| 5   | GND         | 17  | GND         |
| 6   | +5V         | 18  | GND         |
| 7   | GND         | 19  | GND         |
| 8   | Power good  | 20  | -5V         |
| 9   | 5VSB        | 21  | +5V         |
| 10  | +12V        | 22  | +5V         |
| 11  | +12V        | 23  | +5V         |
| 12  | +3.3V       | 24  | GND         |

Table 3-5: ATX Power Connector Pinouts

### 3.2.4 Battery Connector

**CAUTION:**

Risk of explosion if battery is replaced by an incorrect type. Only certified engineers should replace the on-board battery.

Dispose of used batteries according to instructions and local regulations.

---

|                     |                       |
|---------------------|-----------------------|
| <b>CN Label:</b>    | <b>BAT1</b>           |
| <b>CN Type:</b>     | Battery holder        |
| <b>CN Location:</b> | See <b>Figure 3-5</b> |

A system battery is placed in the battery holder. The battery provides power to the system clock to retain the time when power is turned off.

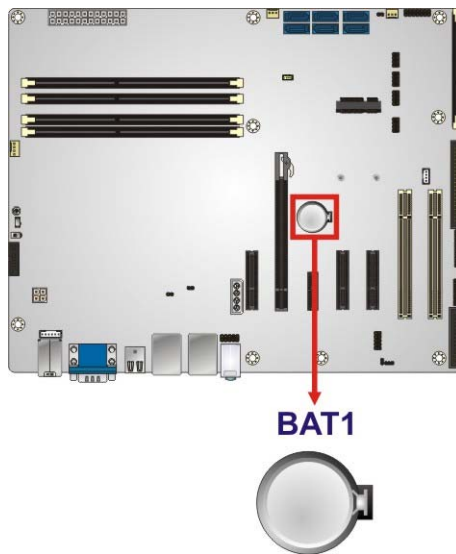

**Figure 3-5: Battery Connector Location**

## IMBA-C2260-i2 ATX Motherboard

### 3.2.5 Chassis Intrusion Connector

- CN Label:** CHASSIS1
- CN Type:** 2-pin header
- CN Location:** See **Figure 3-6**
- CN Pinouts:** See **Table 3-6**

The chassis intrusion connector is for a chassis intrusion detection sensor or switch that detects if a chassis component is removed or replaced.

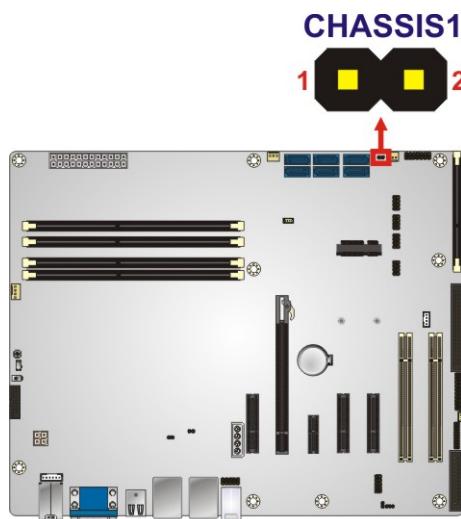

**Figure 3-6: Chassis Intrusion Connector Location**

| Pin | Description  |
|-----|--------------|
| 1   | +3.3VSB      |
| 2   | CHASSIS OPEN |

**Table 3-6: Chassis Intrusion Connector Pinouts**

### 3.2.6 DDR3 DIMM Slots

- CN Label:** CHA\_DIMM1, CHA\_DIMM2, CHB\_DIMM1, CHB\_DIMM2
- CN Type:** DDR3 DIMM slot
- CN Location:** See **Figure 3-7**

The DIMM slots are for DDR3 DIMM memory modules.

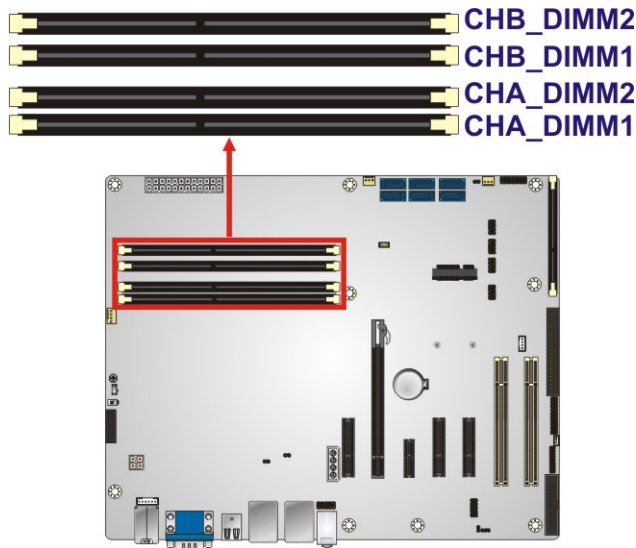

**Figure 3-7: DDR3 DIMM Slot Locations**

### 3.2.7 Digital I/O Connector

- CN Label:** DIO1
- CN Type:** 10-pin header
- CN Location:** See **Figure 3-8**
- CN Pinouts:** See **Table 3-7**

The digital I/O connector provides programmable input and output for external devices. The digital I/O provides 4-bit output and 4-bit input.



**Figure 3-8: Digital I/O Connector Location**

## IMBA-C2260-i2 ATX Motherboard

| Pin | Description | Pin | Description |
|-----|-------------|-----|-------------|
| 1   | GND         | 2   | VCC         |
| 3   | Output 3    | 4   | Output 2    |
| 5   | Output 1    | 6   | Output 0    |
| 7   | Input 3     | 8   | Input 2     |
| 9   | Input 1     | 10  | Input 0     |

**Table 3-7: Digital I/O Connector Pinouts**

### 3.2.8 EC Debug Connector

- CN Label:** CN3
- CN Type:** 18-pin header
- CN Location:** See **Figure 3-9**
- CN Pinouts:** See **Table 3-8**

The EC debug connector is used for EC debug.

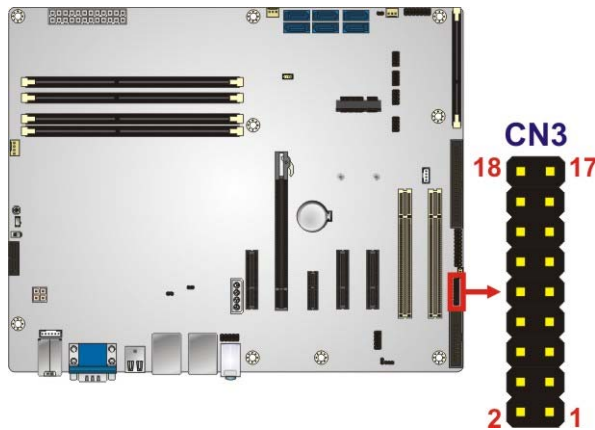

**Figure 3-9: EC Debug Connector Location**

| Pin | Description | Pin | Description  |
|-----|-------------|-----|--------------|
| 1   | EC_EPP_STB# | 2   | EC_EPP_AFD#  |
| 3   | EC_EPP_PDO  | 4   | NC           |
| 5   | EC_EPP_PD1  | 6   | EC_EPP_INIT# |
| 7   | EC_EPP_PD2  | 8   | EC_EPP_SLIN# |
| 9   | EC_EPP_PD3  | 10  | GND          |



| Pin | Description | Pin | Description |
|-----|-------------|-----|-------------|
| 11  | EC_EPP_PD4  | 12  | NC          |
| 13  | EC_EPP_PD5  | 14  | EC_EPP_BUSY |
| 15  | EC_EPP_PD6  | 16  | EC_EPP_KSI5 |
| 17  | EC_EPP_PD7  | 18  | EC_EPP_KSI4 |

**Table 3-8: EC Debug Connector Pinouts**

### 3.2.9 Fan Connector (CPU)

- CN Label:** CPU\_FAN1
- CN Type:** 4-pin wafer
- CN Location:** See **Figure 3-10**
- CN Pinouts:** See **Table 3-9**

The fan connector attaches to a CPU cooling fan.

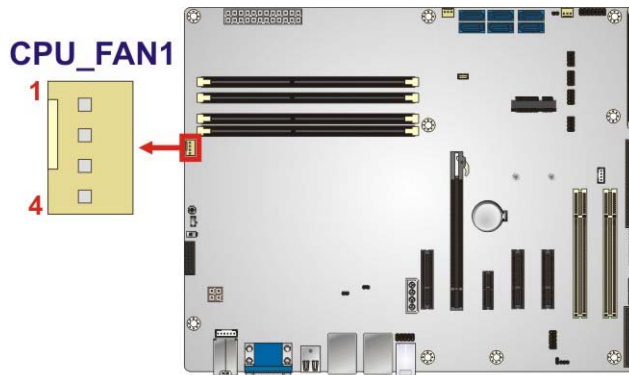

**Figure 3-10: CPU Fan Connector Location**

| Pin | Description |
|-----|-------------|
| 1   | GND         |
| 2   | +12V        |
| 3   | FANIO       |
| 4   | PWM         |

**Table 3-9: CPU Fan Connector Pinouts**

## IMBA-C2260-i2 ATX Motherboard

### 3.2.10 Fan Connectors (System)

**CN Label:** SYS\_FAN1, SYS\_FAN2

**CN Type:** 3-pin wafer

**CN Location:** See **Figure 3-11**

**CN Pinouts:** See **Table 3-10**

Each fan connector attaches to a system cooling fan.

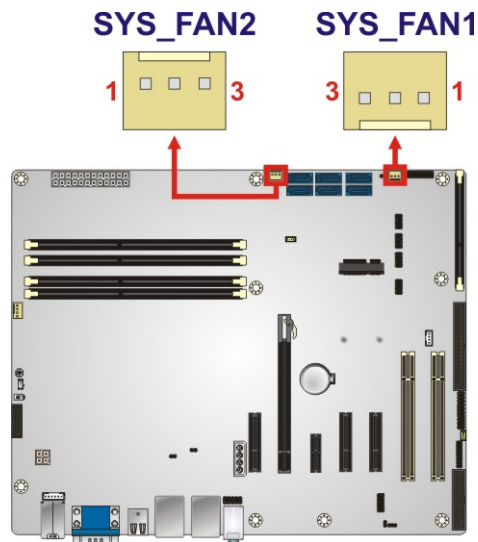

**Figure 3-11: System Fan Connector Locations**

| Pin | Description |
|-----|-------------|
| 1   | FANIO       |
| 2   | +12V (PWM)  |
| 3   | GND         |

**Table 3-10: System Fan Connector Pinouts**

### 3.2.11 Front Panel Audio Connector

**CN Label:** FRONT-PANEL1

**CN Type:** 10-pin header

**CN Location:** See **Figure 3-12**

**CN Pinouts:** See **Table 3-11**

This connector connects to speakers, a microphone and an audio input.

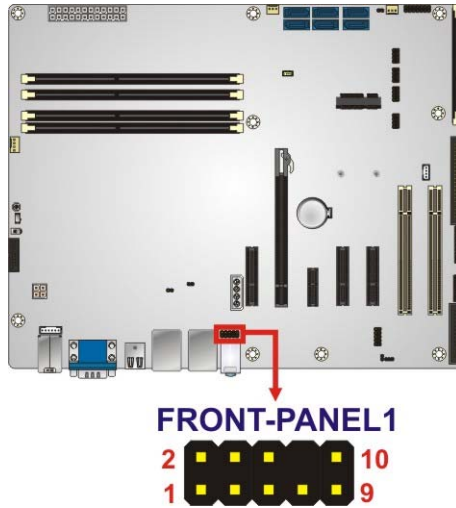

**Figure 3-12: Front Panel Audio Connector Location**

| Pin | Description | Pin | Description |
|-----|-------------|-----|-------------|
| 1   | MIC2-L      | 2   | GND         |
| 3   | MIC2-R      | 4   | Presence#   |
| 5   | LINE2-R     | 6   | MIC2-JD     |
| 7   | FRONT-IO    | 8   | NC          |
| 9   | LINE2-L     | 10  | LINE2-JD    |

**Table 3-11: Front Panel Audio Connector Pinouts**

### 3.2.12 Front Panel Connector

- CN Label:** F\_PANEL1
- CN Type:** 14-pin header
- CN Location:** See **Figure 3-13**
- CN Pinouts:** See **Table 3-12**

The front panel connector connects to the indicator LEDs and buttons on the computer's front panel.

## IMBA-C2260-i2 ATX Motherboard

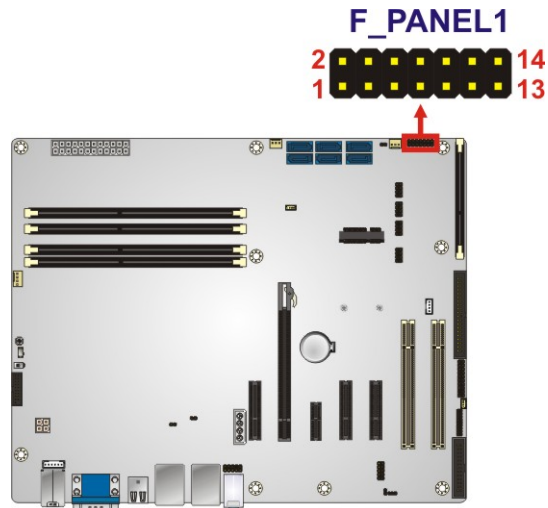

Figure 3-13: Front Panel Connector Location

| Function     | Pin | Description | Function | Pin | Description  |
|--------------|-----|-------------|----------|-----|--------------|
| Power LED    | 1   | +5V         | Speaker  | 2   | BEEP_PWR     |
|              | 3   | NC          | IPMI LED | 4   | IPMI ID_LED+ |
|              | 5   | GND         |          | 6   | IPMI ID_LED- |
| Power Button | 7   | PWRBTN_SW#  | Speaker  | 8   | PC_BEEP      |
|              | 9   | GND         |          | 10  | NC           |
| HDD LED      | 11  | +5V         | Reset    | 12  | EXTRST-      |
|              | 13  | SATA_LED#   |          | 14  | GND          |

Table 3-12: Front Panel Connector Pinouts

### 3.2.13 I<sup>2</sup>C Connector

- CN Label:** CN5
- CN Type:** 4-pin wafer
- CN Location:** See Figure 3-14
- CN Pinouts:** See Table 3-13

The I<sup>2</sup>C connector is used to connect I<sup>2</sup>C-bus devices to the mainboard.

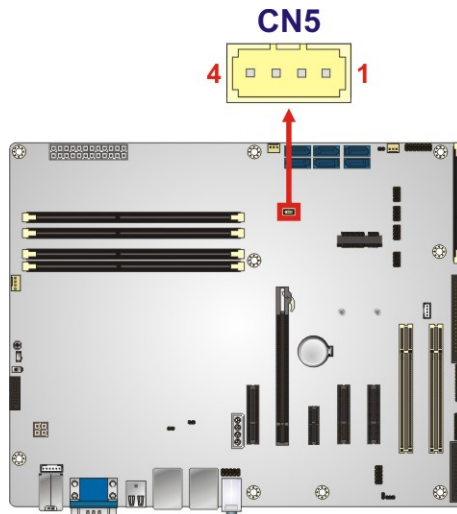

**Figure 3-14: I<sup>2</sup>C Connector Location**

| Pin | Description |
|-----|-------------|
| 1   | GND         |
| 2   | PCH_GP38    |
| 3   | PCH_GP39    |
| 4   | +5V         |

**Table 3-13: I<sup>2</sup>C Connector Pinouts**

### 3.2.14 Internal DisplayPort Connector

- CN Label:** DP1
- CN Type:** 19-pin box header
- CN Location:** See **Figure 3-15**
- CN Pinouts:** See **Table 3-14**

The DisplayPort connector supports HDMI, LVDS, VGA, DVI and DisplayPort graphics interfaces with up to 3840x2160 resolution.

**IMBA-C2260-i2 ATX Motherboard**

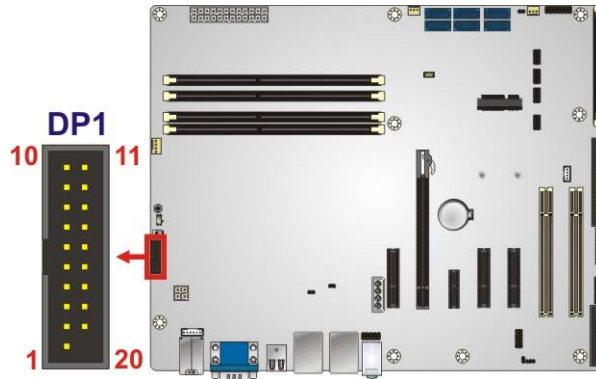

**Figure 3-15: Internal DisplayPort Connector Location**

| Pin | Description    | Pin | Description |
|-----|----------------|-----|-------------|
| 1   | +5V            | 11  | AUXP        |
| 2   | LANE1N         | 12  | AUXN        |
| 3   | LANE1P         | 13  | GND         |
| 4   | GND            | 14  | LANE2P      |
| 5   | LANE3N         | 15  | LANE2N      |
| 6   | LANE3P         | 16  | GND         |
| 7   | GND            | 17  | LANE0P      |
| 8   | AUX_CTRL_DET_D | 18  | LANE0N      |
| 9   | GND            | 19  | +3.3V       |
| 10  | HPD            |     |             |

**Table 3-14: Internal DisplayPort Connector Pinouts**

**3.2.15 iRIS Module Slot**

- CN Label:** IPMI1
- CN Type:** iRIS module slot
- CN Location:** See **Figure 3-16**

The iRIS module slot allows installation of the iRIS-2400 module.

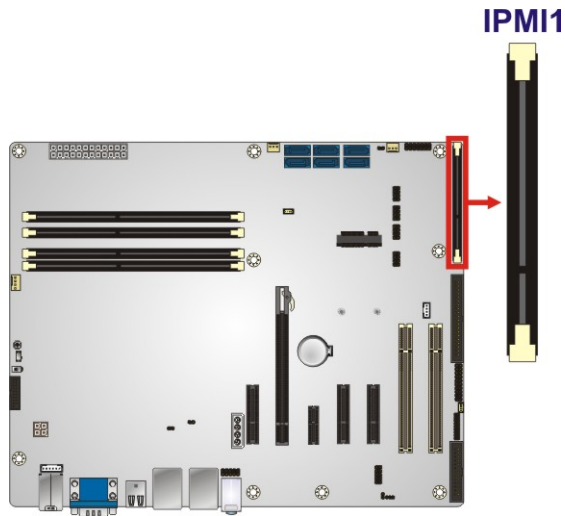

**Figure 3-16: iRIS Module Slot Location**



**WARNING:**

The iRIS module slot is designed to install the iRIS-2400 module only. DO NOT install other modules into the iRIS module slot. Doing so may cause damage to the IMBA-C2260-i2.

### 3.2.16 Keyboard and Mouse Connector

- CN Label:** KB\_MS1
- CN Type:** 6-pin wafer
- CN Location:** See **Figure 3-17**
- CN Pinouts:** See **Table 3-15**

The keyboard and mouse connector connects to a PS/2 Y-cable that can be connected to a PS/2 keyboard and mouse.

**IMBA-C2260-i2 ATX Motherboard**

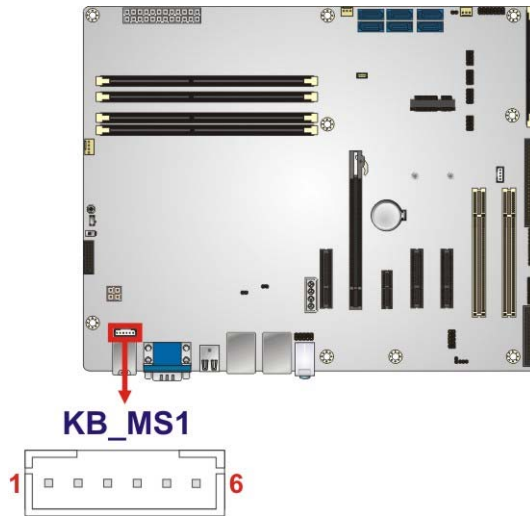

**Figure 3-17: Keyboard and Mouse Connector Location**

| Pin | Description    |
|-----|----------------|
| 1   | VCC            |
| 2   | Mouse Data     |
| 3   | Mouse Clock    |
| 4   | Keyboard Data  |
| 5   | Keyboard Clock |
| 6   | GND            |

**Table 3-15: Keyboard and Mouse Connector Pinouts**

**3.2.17 LAN LED Connectors**

- CN Label:** LED\_LAN1, LED\_LAN2
- CN Type:** 2-pin header
- CN Location:** See **Figure 3-18**
- CN Pinouts:** See **Table 3-16** and **Table 3-17**

The LAN LED connectors are used to connect to the LAN LED indicators on the chassis to indicate users the link activities of the two LAN ports.



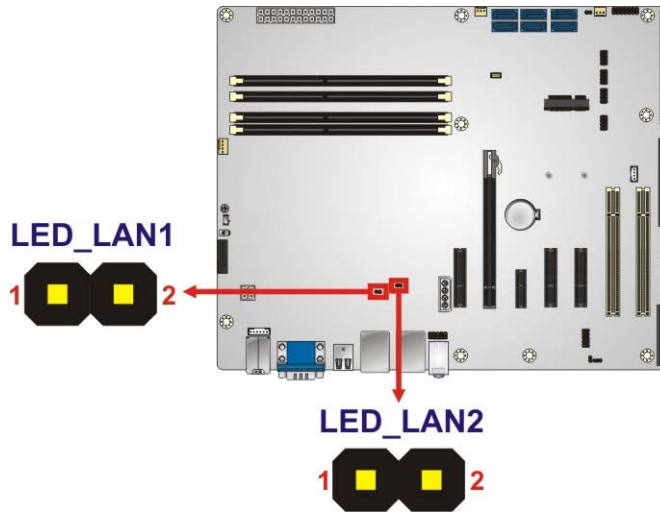

**Figure 3-18: LAN LED Connector Locations**

| Pin | Description        |
|-----|--------------------|
| 1   | +3.3V              |
| 2   | LAN1_LED_LINK#_ACT |

**Table 3-16: LAN1 LED Connector (LED\_LAN1) Pinouts**

| Pin | Description        |
|-----|--------------------|
| 1   | +3.3V              |
| 2   | LAN2_LED_LINK#_ACT |

**Table 3-17: LAN2 LED Connector (LED\_LAN2) Pinouts**

### 3.2.18 mSATA Card Slot

- CN Label:** CN2
- CN Type:** PCIe Mini slot
- CN Location:** See **Figure 3-19**
- CN Pinouts:** See **Table 3-18**

The mSATA card slot is for installing mSATA cards or USB devices only

IMBA-C2260-i2 ATX Motherboard



**NOTE:**

If the user shorts the mSATA Slot Setup jumper (MSATA\_SW1) to force the system to enable mSATA device, the S\_ATA6 connector will be disabled. Please refer to **Section 4.5.4**.

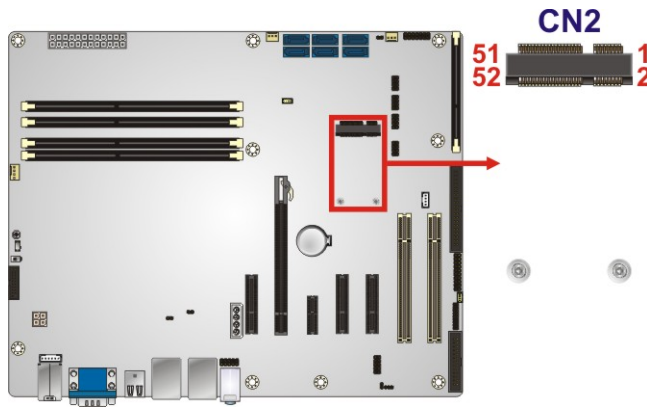

**Figure 3-19: mSATA Card Slot Location**

| Pin | Description | Pin | Description |
|-----|-------------|-----|-------------|
| 1   | PCIE_WAKE#  | 2   | +3.3V       |
| 3   | N/C         | 4   | GND         |
| 5   | N/C         | 6   | 1.5V        |
| 7   | N/C         | 8   | N/C         |
| 9   | GND         | 10  | N/C         |
| 11  | MSATA_CLK#  | 12  | N/C         |
| 13  | MSATA_CLK   | 14  | N/C         |
| 15  | GND         | 16  | N/C         |
| 17  | PLTRST_N    | 18  | GND         |
| 19  | N/C         | 20  | +3.3V       |
| 21  | GND         | 22  | PLTRST_N    |
| 23  | SATA_RX+    | 24  | +3.3V       |
| 25  | SATA_RX-    | 26  | GND         |
| 27  | GND         | 28  | 1.5V        |
| 29  | GND         | 30  | SMB_CLK     |

| Pin | Description | Pin | Description |
|-----|-------------|-----|-------------|
| 31  | SATA_TX-    | 32  | SMB_DATA    |
| 33  | SATA_TX+    | 34  | GND         |
| 35  | GND         | 36  | USB_DATA-   |
| 37  | GND         | 38  | USB_DATA+   |
| 39  | +3.3V       | 40  | GND         |
| 41  | +3.3V       | 42  | N/C         |
| 43  | +3.3V       | 44  | N/C         |
| 45  | CLINK_CLK   | 46  | N/C         |
| 47  | CLINK_DATA  | 48  | 1.5V        |
| 49  | CLINK_RST#  | 50  | GND         |
| 51  | MSATA_DET   | 52  | +3.3V       |

**Table 3-18: mSATA Card Slot Pinouts**

### 3.2.19 Parallel Port Connector

- CN Label:** LPT1
- CN Type:** 26-pin box header
- CN Location:** See **Figure 3-20**
- CN Pinouts:** See **Table 3-19**

The parallel port connector connects to a parallel port connector interface or some other parallel port device such as a printer.

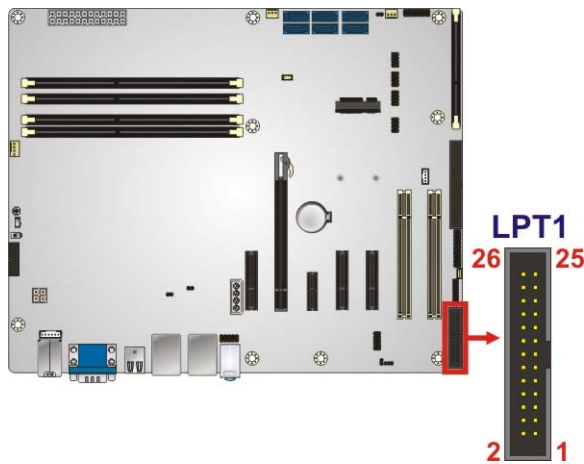

**Figure 3-20: Parallel Port Connector Location**

**IMBA-C2260-i2 ATX Motherboard**

| Pin | Description        | Pin | Description      |
|-----|--------------------|-----|------------------|
| 1   | STROBE#            | 2   | DATA0            |
| 3   | DATA1              | 4   | DATA2            |
| 5   | DATA3              | 6   | DATA4            |
| 7   | DATA5              | 8   | DATA6            |
| 9   | DATA7              | 10  | ACKNOWLEDGE#     |
| 11  | BUSY               | 12  | PAPER EMPTY      |
| 13  | PRINTER SELECT     | 14  | AUTO FORM FEED # |
| 15  | ERROR#             | 16  | INITIALIZE#      |
| 17  | PRINTER SELECT LN# | 18  | GND              |
| 19  | GND                | 20  | GND              |
| 21  | GND                | 22  | GND              |
| 23  | GND                | 24  | GND              |
| 25  | GND                |     |                  |

**Table 3-19: Parallel Port Connector Pinouts**

**3.2.20 PCI Slots**

- CN Label:** PCI1, PCI2
- CN Type:** PCI Slot
- CN Location:** See **Figure 3-21**

The PCI slot enables a PCI expansion module to be connected to the board.

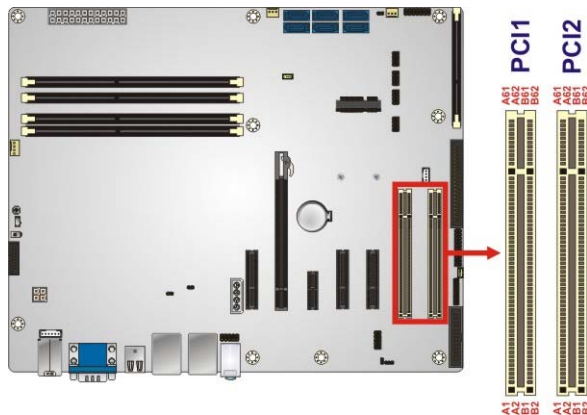
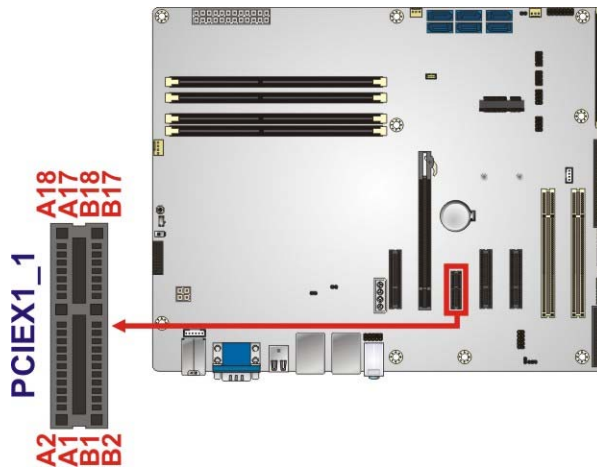

**Figure 3-21: PCI Slot Locations**

### 3.2.21 PCIe x1 Slot

- CN Label:** PCIEX1\_1
- CN Type:** PCIe x1 slot
- CN Location:** See **Figure 3-22**

The PCIe x1 slot is for PCIe x1 expansion card.



**Figure 3-22: PCIe x1 Slot Location**

### 3.2.22 PCIe x4 Slots

- CN Label:** PCIEX4\_1, PCIEX4\_2, PCIEX4\_3
- CN Type:** PCIe x4 slot
- CN Location:** See **Figure 3-23**

The PCIe x4 expansion card slots are for PCIe x4 expansion cards.

## IMBA-C2260-i2 ATX Motherboard

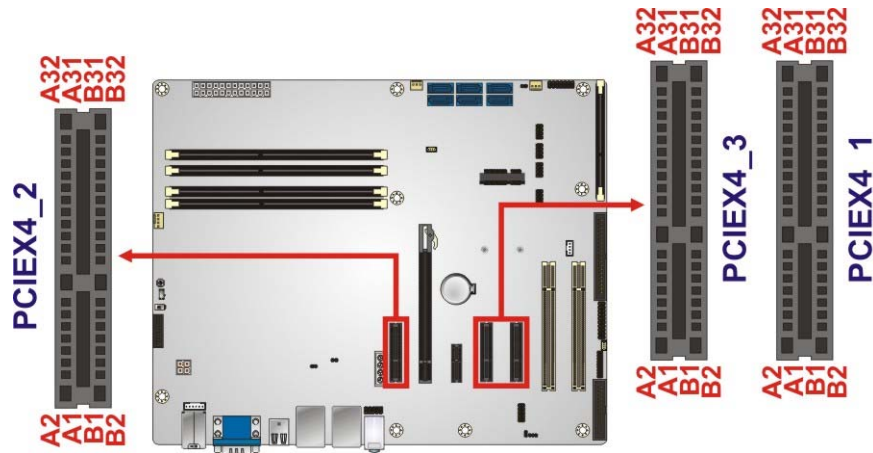

Figure 3-23: PCIe x4 Slot Locations

### 3.2.23 PCI Express x16 Slot

|              |                 |
|--------------|-----------------|
| CN Label:    | PCIEX16_1       |
| CN Type:     | PCIe x16 slot   |
| CN Location: | See Figure 3-24 |



#### NOTE:

The PCIe x16 interface setup is made through the BIOS menu in “Chipset → PCH-IO Configuration”. Use the **PEG port configuration** BIOS option to configure the PCIe x16 channel mode. Please refer to **Section 5.4.1** for detailed information.

The PCIe x16 expansion card slot is for PCIe x16 expansion card.

**PCIEX16\_1**

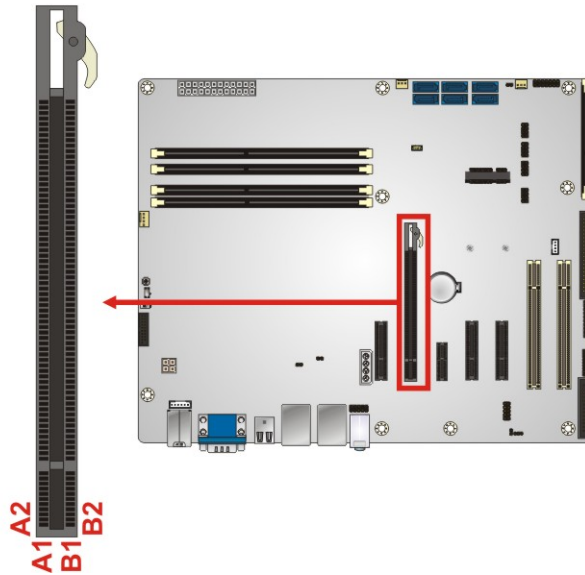
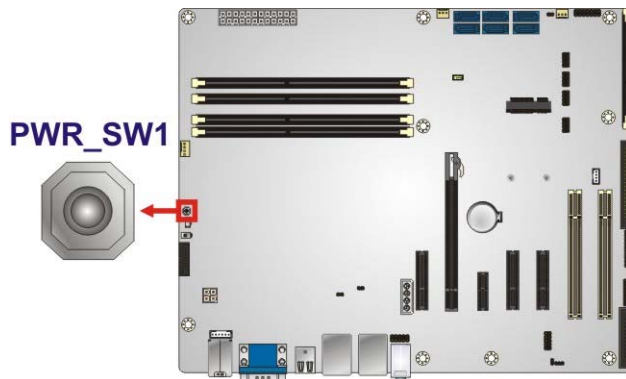

**Figure 3-24: PCIe x16 Slot Location**

### 3.2.24 Power Button

- CN Label:** PWR\_SW1
- CN Type:** Push button
- CN Location:** See **Figure 3-25**

The on-board power button controls system power.



**Figure 3-25: Power Button Location**

## IMBA-C2260-i2 ATX Motherboard

### 3.2.25 SATA 6Gb/s Drive Connector

**CN Label:** S\_ATA1, S\_ATA2, S\_ATA3, S\_ATA4, S\_ATA5, S\_ATA6

**CN Type:** 7-pin SATA drive connector

**CN Location:** See Figure 3-26

**CN Pinouts:** See Table 3-20

The SATA drive connectors can be connected to SATA drives and support up to 6Gb/s data transfer rate.

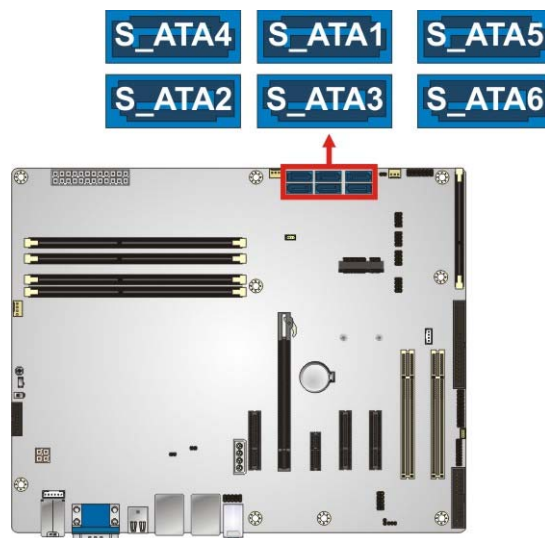

**Figure 3-26: SATA 6Gb/s Drive Connector Location**

| Pin | Description |
|-----|-------------|
| 1   | GND         |
| 2   | SATA_TX+    |
| 3   | SATA_TX-    |
| 4   | GND         |
| 5   | SATA_RX-    |
| 6   | SATA RX+    |
| 7   | GND         |

**Table 3-20: SATA 6Gb/s Drive Connector Pinouts**





**NOTE:**

If the user shorts the mSATA Slot Setup jumper (MSATA\_SW1) to force the system to enable mSATA device, the S\_ATA6 connector will be disabled. Please refer to **Section 4.5.4**.

**3.2.26 Serial Port Connector, RS-232**

- CN Label:** COM2,COM3,COM5,COM6
- CN Type:** 40-pin box header
- CN Location:** See **Figure 3-27**
- CN Pinouts:** See **Table 3-21**

The connector provides four RS-232 ports connection.

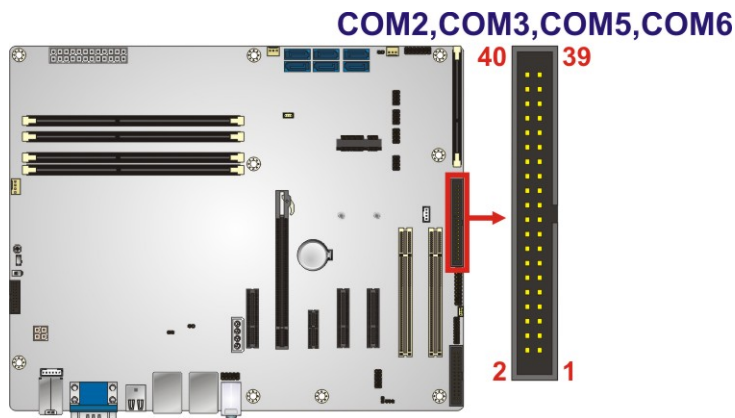

**Figure 3-27: RS-232 Serial Port Connector Location**

|      | Pin | Description | Pin | Description |
|------|-----|-------------|-----|-------------|
| COM2 | 1   | DCD         | 2   | DSR         |
|      | 3   | RXD         | 4   | RTS         |
|      | 5   | TXD         | 6   | CTS         |
|      | 7   | DTR         | 8   | RI          |
|      | 9   | GND         | 10  | GND         |

## IMBA-C2260-i2 ATX Motherboard

|      | Pin | Description | Pin | Description |
|------|-----|-------------|-----|-------------|
| COM3 | 11  | DCD         | 12  | DSR         |
|      | 13  | RXD         | 14  | RTS         |
|      | 15  | TXD         | 16  | CTS         |
|      | 17  | DTR         | 18  | RI          |
|      | 19  | GND         | 20  | GND         |
| COM5 | 21  | DCD         | 22  | DSR         |
|      | 23  | RXD         | 24  | RTS         |
|      | 25  | TXD         | 26  | CTS         |
|      | 27  | DTR         | 28  | RI          |
|      | 29  | GND         | 30  | GND         |
| COM6 | 31  | DCD         | 32  | DSR         |
|      | 33  | RXD         | 34  | RTS         |
|      | 35  | TXD         | 36  | CTS         |
|      | 37  | DTR         | 38  | RI          |
|      | 39  | GND         | 40  | GND         |

**Table 3-21: RS-232 Serial Port Connector Pinouts**

### 3.2.27 Serial Port Connector, RS-422/485

- CN Label:** COM4
- CN Type:** 4-pin wafer
- CN Location:** See **Figure 3-28**
- CN Pinouts:** See **Table 3-22**

This connector provides RS-422 or RS-485 communications.



**Figure 3-28: RS-422/485 Connector Location**

| Pin | Description | Pin | Description     |
|-----|-------------|-----|-----------------|
| 1   | RXD422-     | 3   | TXD422+/TXD485+ |
| 2   | RXD422+     | 4   | TXD422-/TXD485- |

**Table 3-22: RS-422/485 Connector Pinouts**

Use the optional RS-422/485 cable to connect to a serial device. The pinouts of the DB-9 connector are listed below.

| RS-422 Pinouts | RS-485 Pinouts |
|----------------|----------------|
|                |                |

**Table 3-23: DB-9 RS-422/485 Pinouts**

### 3.2.28 SMBus Connector

- CN Label:** CN1
- CN Type:** 4-pin wafer
- CN Location:** See **Figure 3-29**
- CN Pinouts:** See **Table 3-24**

The SMBus (System Management Bus) connector provides low-speed system management communications.

IMBA-C2260-i2 ATX Motherboard



Figure 3-29: SMBus Connector Location

| Pin | Description |
|-----|-------------|
| 1   | GND         |
| 2   | SMB_DATA    |
| 3   | SMB_CLK     |
| 4   | +5V         |

Table 3-24: SMBus Connector Pinouts

3.2.29 SPI Flash Connector

- CN Label:** JSPI1
- CN Type:** 8-pin header
- CN Location:** See Figure 3-30
- CN Pinouts:** See Table 3-25

The SPI flash connector is used to flash the SPI ROM.



Figure 3-30: SPI Flash Connector Location

| Pin | Description | Pin | Description |
|-----|-------------|-----|-------------|
| 1   | +3.3V       | 2   | SPI_CS#     |
| 3   | SPI_SO      | 4   | NC          |
| 5   | GND         | 6   | SPI_CLK     |
| 7   | SPI_SI      | 8   | NC          |

**Table 3-25: SPI Flash Connector Pinouts**

### 3.2.30 SPI Flash Connector, EC

- CN Label:** JSPI2
- CN Type:** 8-pin header
- CN Location:** See **Figure 3-31**
- CN Pinouts:** See **Table 3-26**

The SPI flash connector is used to flash the EC ROM.

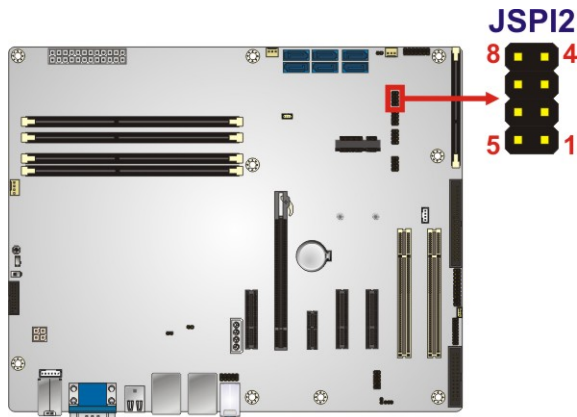

**Figure 3-31: SPI EC Flash Connector Location**

| Pin | Description | Pin | Description |
|-----|-------------|-----|-------------|
| 1   | +3.3V       | 2   | SPI_CS#     |
| 3   | SPI_SO      | 4   | NC          |
| 5   | GND         | 6   | SPI_CLK     |
| 7   | SPI_SI      | 8   | NC          |

**Table 3-26: SPI EC Flash Connector Pinouts**

## IMBA-C2260-i2 ATX Motherboard

### 3.2.31 TPM Connector

- CN Label:** TPM1
- CN Type:** 20-pin header
- CN Location:** See **Figure 3-32**
- CN Pinouts:** See **Table 3-27**

The TPM connector connects to a TPM module.

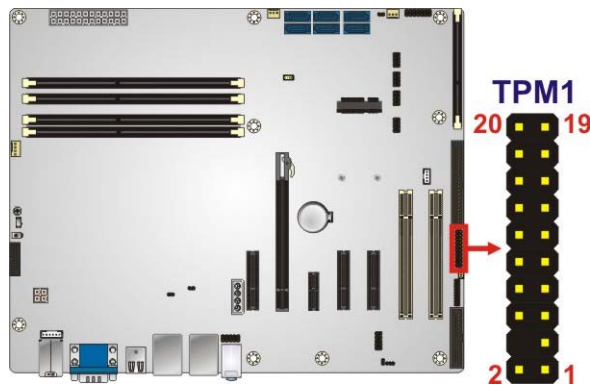

**Figure 3-32: TPM Connector Location**

| Pin | Description | Pin | Description |
|-----|-------------|-----|-------------|
| 1   | LCLK        | 2   | GND         |
| 3   | LFRAME#     | 4   | KEY         |
| 5   | LRERST#     | 6   | +5V         |
| 7   | LAD3        | 8   | LAD2        |
| 9   | +3.3V       | 10  | LAD1        |
| 11  | LAD0        | 12  | GND         |
| 13  | SCL         | 14  | SDA         |
| 15  | SB3V        | 16  | SERIRQ      |
| 17  | GND         | 18  | GLKRUN#     |
| 19  | LPCPD#      | 20  | LDRO#       |

**Table 3-27: TPM Connector Pinouts**

**3.2.32 USB 2.0 Connectors**

- CN Label:** USB1, USB2
- CN Type:** 8-pin header
- CN Location:** See **Figure 3-33**
- CN Pinouts:** See **Table 3-28**

The USB 2.0 connectors connect to USB 2.0 devices. Each pin header provides two USB 2.0 ports.

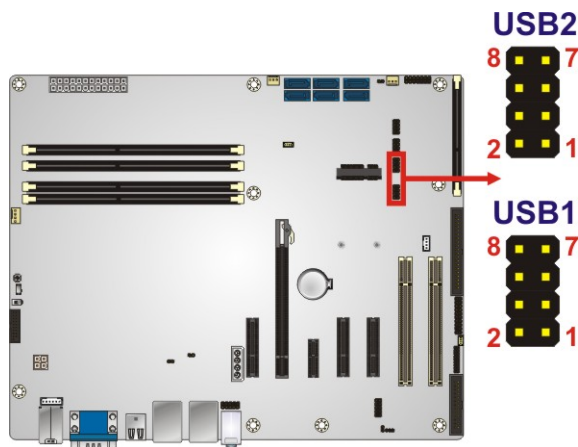

**Figure 3-33: USB 2.0 Connector Pinout Locations**

| Pin | Description | Pin | Description |
|-----|-------------|-----|-------------|
| 1   | VCC         | 2   | GND         |
| 3   | USB_DATA-   | 4   | USB_DATA+   |
| 5   | USB_DATA+   | 6   | USB_DATA-   |
| 7   | GND         | 8   | VCC         |

**Table 3-28: USB 2.0 Connector Pinouts**

## IMBA-C2260-i2 ATX Motherboard

### 3.3 External Peripheral Interface Connector Panel

The figure below shows the external peripheral interface connector (EPIC) panel. The EPIC panel consists of the following:

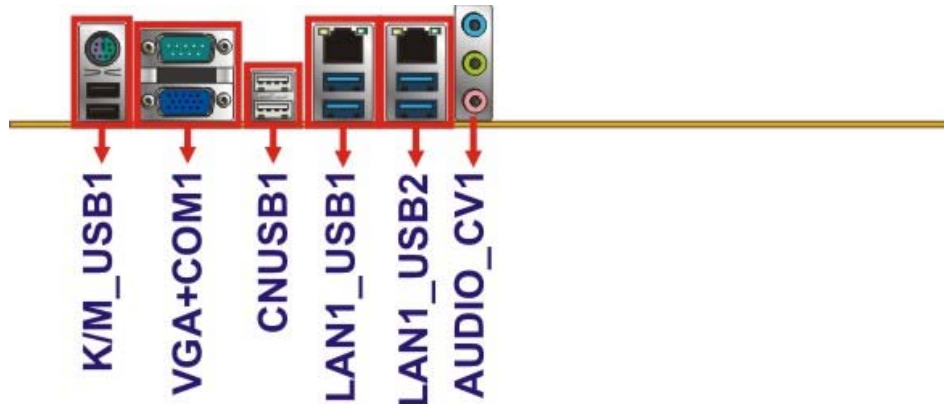

Figure 3-34: External Peripheral Interface Connector

#### 3.3.1 Audio Connector

|                     |                        |
|---------------------|------------------------|
| <b>CN Label:</b>    | <b>AUDIO_CV1</b>       |
| <b>CN Type:</b>     | Audio jack             |
| <b>CN Location:</b> | See <b>Figure 3-34</b> |

The audio jacks connect to external audio devices.

- **Line In port (Light Blue):** Connects a CD-ROM, DVD player, or other audio devices.
- **Line Out port (Lime):** Connects to a headphone or a speaker. With multi-channel configurations, this port can also connect to front speakers.
- **Microphone (Pink):** Connects a microphone.



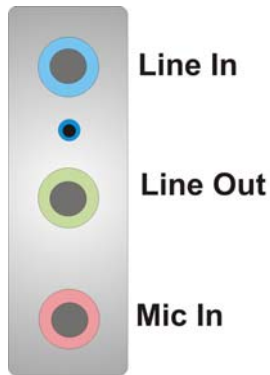

**Figure 3-35: Audio Connector**

### 3.3.2 Ethernet and USB 3.0 Connectors

- CN Label:** LAN1\_USB1, LAN1\_USB2
- CN Type:** RJ-45, USB 3.0
- CN Location:** See **Figure 3-34**
- CN Pinouts:** See **Table 3-29** and **Table 3-30**

There are four external USB 3.0 connectors on the IMBA-C2260-i2.

| Pin | Description | Pin | Description |
|-----|-------------|-----|-------------|
| 1   | VCC         | 10  | VCC         |
| 2   | USB_DATA-   | 11  | USB_DATA-   |
| 3   | USB_DATA+   | 12  | USB_DATA+   |
| 4   | GND         | 13  | GND         |
| 5   | USB3_RX-    | 14  | USB3_RX-    |
| 6   | USB3_RX+    | 15  | USB3_RX+    |
| 7   | GND         | 16  | GND         |
| 8   | USB3_TX-    | 17  | USB3_TX-    |
| 9   | USB3_TX+    | 18  | USB3_TX+    |

**Table 3-29: USB 3.0 Port Pinouts**

Each LAN connector connects to a local network

## IMBA-C2260-i2 ATX Motherboard

| Pin | Description | Pin | Description |
|-----|-------------|-----|-------------|
| 20  | LAN1_MDI0P  | 24  | LAN1_MDI2P  |
| 21  | LAN1_MDI0N  | 25  | LAN1_MDI2N  |
| 22  | LAN1_MDI1P  | 26  | LAN1_MDI3P  |
| 23  | LAN1_MDI1N  | 27  | LAN1_MDI3N  |

**Table 3-30: LAN Pinouts**

### 3.3.3 Keyboard/Mouse and USB 2.0 Connectors

**CN Label:** K/M\_USB1

**CN Type:** PS/2, USB 2.0

**CN Location:** See **Figure 3-34**

**CN Pinouts:** See **Table 3-31** and **Table 3-32**

The USB 2.0 connector can be connected to a USB device.

| Pin | Description | Pin | Description |
|-----|-------------|-----|-------------|
| 1   | VCC         | 5   | VCC         |
| 2   | USB_DATA-   | 6   | USB_DATA-   |
| 3   | USB_DATA+   | 7   | USB_DATA+   |
| 4   | GND         | 8   | GND         |

**Table 3-31: USB 2.0 Port Pinouts**

The PS/2 port is for connecting a PS/2 mouse and a PS/2 keyboard.

| Pin | Description    |
|-----|----------------|
| 9   | GND            |
| 10  | Keyboard Data  |
| 11  | Mouse Data     |
| 12  | VCC            |
| 13  | Keyboard Clock |
| 14  | Mouse Clock    |

**Table 3-32: PS/2 Connector Pinouts**

**3.3.4 Serial Port and VGA Connector**

- CN Label:** VGACOM1
- CN Type:** DB-9 and 15-pin VGA connector
- CN Location:** See **Figure 3-34**
- CN Pinouts:** See **Table 3-33**

The serial port connects to a RS-232 serial communications device.

| Pin | Description | Pin | Description |
|-----|-------------|-----|-------------|
| 1   | DCD1        | 6   | DSR1        |
| 2   | RXD1        | 7   | RTS1        |
| 3   | TXD1        | 8   | CTS1        |
| 4   | DTR1        | 9   | RI1         |
| 5   | GND         |     |             |

**Table 3-33: Serial Port Connector Pinouts**

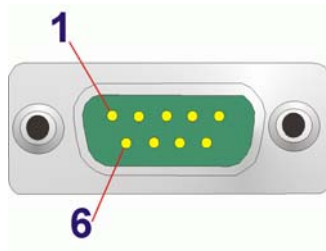

**Figure 3-36: Serial Port Connector Pinouts**

The 15-pin VGA connector connects to a monitor that accepts a standard VGA input.

| Pin | Description | Pin | Description |
|-----|-------------|-----|-------------|
| 1   | RED         | 2   | GREEN       |
| 3   | BLUE        | 4   | NC          |
| 5   | GND         | 6   | GND         |
| 7   | GND         | 8   | GND         |
| 9   | VCC         | 10  | GND         |
| 11  | NC          | 12  | DCCDA       |

## IMBA-C2260-i2 ATX Motherboard

| Pin | Description | Pin | Description |
|-----|-------------|-----|-------------|
| 13  | HSYNC       | 14  | VSYNC       |
| 15  | DDCCLK      |     |             |

**Table 3-34: VGA Connector Pinouts**

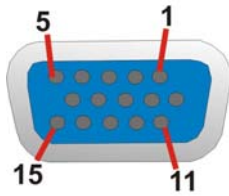

**Figure 3-37: VGA Connector**

### 3.3.5 USB 2.0 Connectors

- CN Label:** CNUSB1
- CN Type:** USB 2.0
- CN Location:** See **Figure 3-34**
- CN Pinouts:** See **Table 3-35**

Each USB 2.0 connector can be connected to a USB 2.0 device.

| Pin | Description | Pin | Description |
|-----|-------------|-----|-------------|
| 1   | VCC         | 5   | VCC         |
| 2   | USB_DATA-   | 6   | USB_DATA-   |
| 3   | USB_DATA+   | 7   | USB_DATA+   |
| 4   | GND         | 8   | GND         |

**Table 3-35: USB 2.0 Port Pinouts**

Chapter

4

# Installation

---

## IMBA-C2260-i2 ATX Motherboard

### 4.1 Anti-static Precautions

---



#### WARNING:

Failure to take ESD precautions during the installation of the IMBA-C2260-i2 may result in permanent damage to the IMBA-C2260-i2 and severe injury to the user.

---

Electrostatic discharge (ESD) can cause serious damage to electronic components, including the IMBA-C2260-i2. Dry climates are especially susceptible to ESD. It is therefore critical that whenever the IMBA-C2260-i2 or any other electrical component is handled, the following anti-static precautions are strictly adhered to.

- ***Wear an anti-static wristband:*** - Wearing a simple anti-static wristband can help to prevent ESD from damaging the board.
- ***Self-grounding:***- Before handling the board touch any grounded conducting material. During the time the board is handled, frequently touch any conducting materials that are connected to the ground.
- ***Use an anti-static pad:*** When configuring the IMBA-C2260-i2, place it on an anti-static pad. This reduces the possibility of ESD damaging the IMBA-C2260-i2.
- ***Only handle the edges of the PCB:-:*** When handling the PCB, hold the PCB by the edges.

### 4.2 Installation Considerations

---



#### NOTE:

The following installation notices and installation considerations should be read and understood before installation. All installation notices must be strictly adhered to. Failing to adhere to these precautions may lead to severe damage and injury to the person performing the installation.

---

**WARNING:**

The installation instructions described in this manual should be carefully followed in order to prevent damage to the components and injury to the user.

Before and during the installation please **DO** the following:

- Read the user manual:
  - The user manual provides a complete description of the IMBA-C2260-i2 installation instructions and configuration options.
- Wear an electrostatic discharge cuff (ESD):
  - Electronic components are easily damaged by ESD. Wearing an ESD cuff removes ESD from the body and helps prevent ESD damage.
- Place the IMBA-C2260-i2 on an anti-static pad:
  - When installing or configuring the motherboard, place it on an anti-static pad. This helps to prevent potential ESD damage.
- Turn all power to the IMBA-C2260-i2 off:
  - When working with the IMBA-C2260-i2, make sure that it is disconnected from all power supplies and that no electricity is being fed into the system.

Before and during the installation of the IMBA-C2260-i2, **DO NOT:**

- Remove any of the stickers on the PCB board. These stickers are required for warranty validation.
- Use the product before verifying all the cables and power connectors are properly connected.
- Allow screws to come in contact with the PCB circuit, connector pins, or its components.

## IMBA-C2260-i2 ATX Motherboard

### 4.2.1 Socket LGA1150 CPU Installation



#### **WARNING:**

CPUs are expensive and sensitive components. When installing the CPU please be careful not to damage it in anyway. Make sure the CPU is installed properly and ensure the correct cooling kit is properly installed.

DO NOT touch the pins at the bottom of the CPU. When handling the CPU, only hold it on the sides.

To install the CPU, follow the steps below.

**Step 1:** **Disengage the load lever** by pressing the lever down and slightly outward to clear the retention tab. Fully open the lever. See **Figure 4-1**.

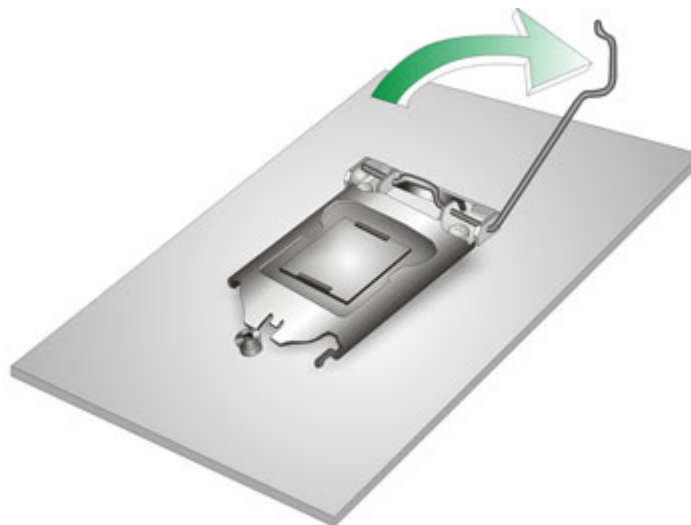

**Figure 4-1: Disengage the CPU Socket Load Lever**

**Step 2:** **Open the socket and remove the protective cover.** The black protective cover can be removed by pulling up on the tab labeled "Remove". See **Figure 4-2**.



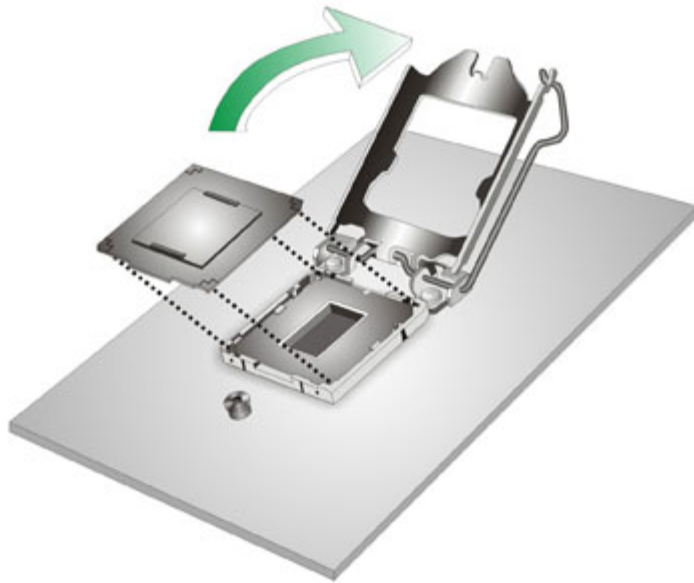

**Figure 4-2: Remove Protective Cover**

- Step 3: Inspect the CPU socket.** Make sure there are no bent pins and make sure the socket contacts are free of foreign material. If any debris is found, remove it with compressed air.
- Step 4: Orientate the CPU properly.** The contact array should be facing the CPU socket.



**WARNING:**

DO NOT touch the pins at the bottom of the CPU. When handling the CPU, only hold it on the sides.

- 
- Step 5: Correctly position the CPU.** Match the Pin 1 mark with the cut edge on the CPU socket.
- Step 6: Align the CPU pins.** Locate pin 1 and the two orientation notches on the CPU. Carefully match the two orientation notches on the CPU with the socket alignment keys.

## IMBA-C2260-i2 ATX Motherboard

**Step 7: Insert the CPU.** Gently insert the CPU into the socket. If the CPU pins are properly aligned, the CPU should slide into the CPU socket smoothly. See **Figure 4-3**.

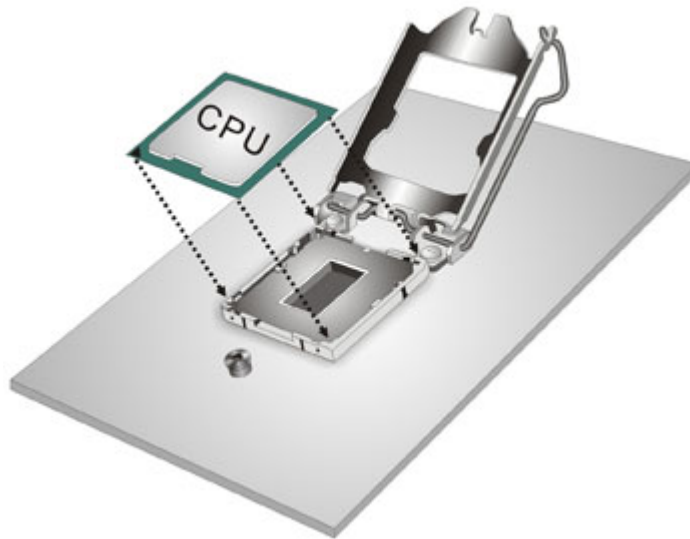

**Figure 4-3: Insert the Socket LGA1150 CPU**

**Step 8: Close the CPU socket.** Close the load plate and pull the load lever back a little to have the load plate be able to secure to the knob. Engage the load lever by pushing it back to its original position (**Figure 4-4**). There will be some resistance, but will not require extreme pressure.

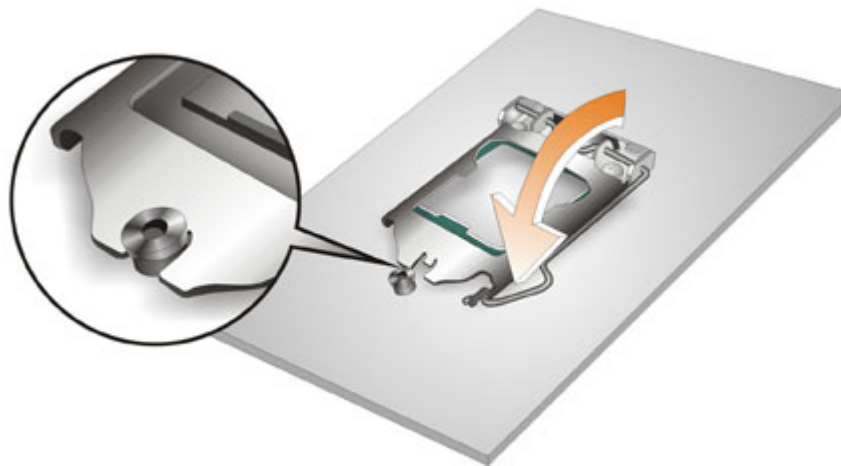

**Figure 4-4: Close the Socket LGA1150**

**Step 9:** Connect the 12 V power to the board. Connect the 12 V power from the power supply to the board.

#### 4.2.2 Socket LGA1150 Cooling Kit Installation

---



**WARNING:**

**DO NOT** attempt to install a push-pin cooling fan.

The pre-installed support bracket prevents the board from bending and is **ONLY** compatible with captive screw type cooling fans.

---

The cooling kit can be bought from IEI. The cooling kit has a heat sink and fan.

---



**WARNING:**

Do not wipe off (accidentally or otherwise) the pre-sprayed layer of thermal paste on the bottom of the heat sink. The thermal paste between the CPU and the heat sink is important for optimum heat dissipation.

---

To install the cooling kit, follow the instructions below.

**Step 1:** A cooling kit bracket is pre-installed on the rear of the motherboard. See **Figure 4-5**.

## IMBA-C2260-i2 ATX Motherboard

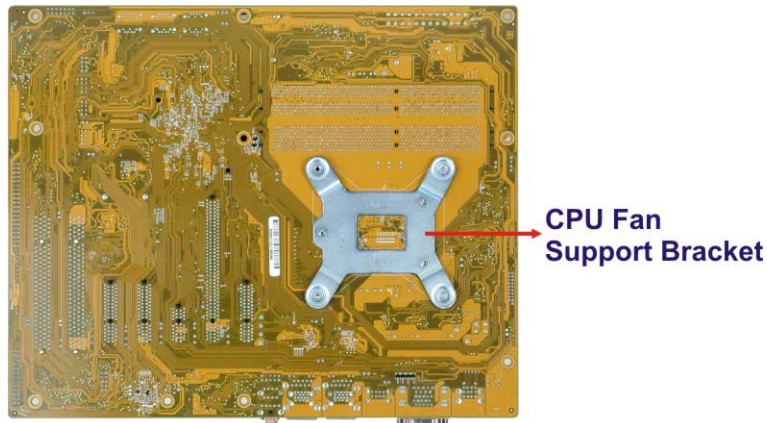
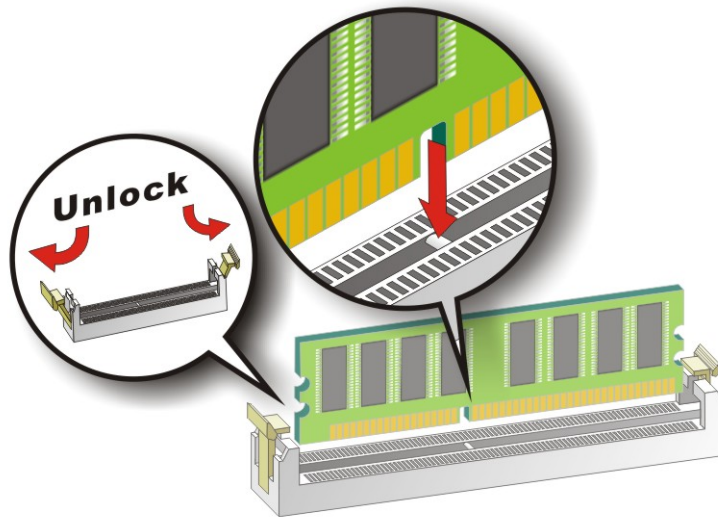

**Figure 4-5: Cooling Kit Support Bracket**

- Step 2:** Place the cooling kit onto the socket LGA1150 CPU. Make sure the CPU cable can be properly routed when the cooling kit is installed.
- Step 3:** Mount the cooling kit. Gently place the cooling kit on top of the CPU. Make sure the four threaded screws on the corners of the cooling kit properly pass through the holes of the cooling kit bracket.
- Step 4:** Secure the cooling kit by fastening the four retention screws of the cooling kit.
- Step 5:** Connect the fan cable. Connect the cooling kit fan cable to the CPU fan connector on the IMBA-C2260-i2. Carefully route the cable and avoid heat generating chips and fan blades.

### 4.2.3 DIMM Installation

To install a DIMM, please follow the steps below and refer to **Figure 4-6**.



**Figure 4-6: DIMM Installation**

- Step 1: Open the DIMM socket handles.** Open the two handles outwards as far as they can. See **Figure 4-6**.
- Step 2: Align the DIMM with the socket.** Align the DIMM so the notch on the memory lines up with the notch on the memory socket. See **Figure 4-6**.
- Step 3: Insert the DIMM.** Once aligned, press down until the DIMM is properly seated. Clip the two handles into place. See **Figure 4-6**.
- Step 4: Removing a DIMM.** To remove a DIMM, push both handles outward. The memory module is ejected by a mechanism in the socket.

## IMBA-C2260-i2 ATX Motherboard

## 4.3 iRIS Module Installation

**WARNING:**

The iRIS module slot is designed to install the iRIS-2400 module only. DO NOT install other modules into the iRIS module slot. Doing so may cause damage to the IMBA-C2260-i2.

To install the iRIS-2400 module, please follow the steps below and refer to **Figure 4-7**.

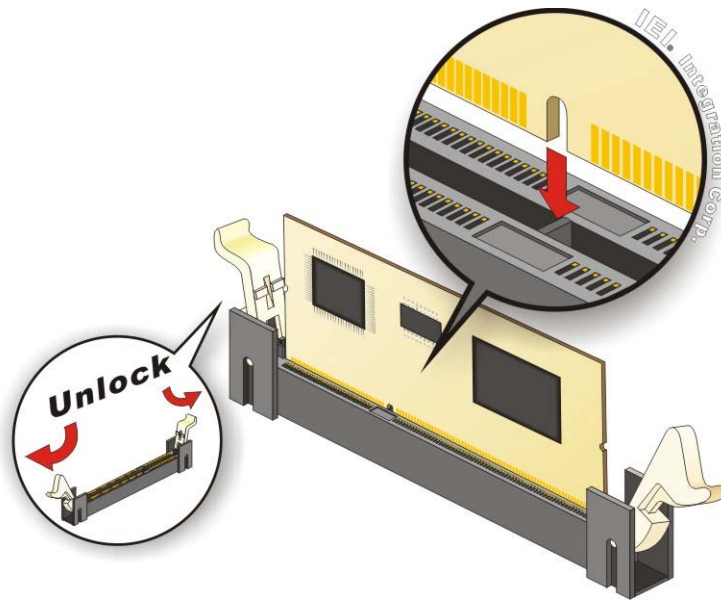

**Figure 4-7: iRIS Module Installation**

- Step 1:** Locate the iRIS module slot. See **Figure 3-16**.
- Step 2:** **Open the socket handles.** Open the two handles outwards as far as they can. See **Figure 4-7**.
- Step 3:** **Align the iRIS-2400 module with the socket.** Align the iRIS-2400 module so the notch on the module lines up with the notch on the socket. See **Figure 4-7**.
- Step 4:** **Insert the iRIS-2400 module.** Once aligned, press down until the iRIS-2400 module is properly seated. Clip the two handles into place. See **Figure 4-7**.

**Step 5: Removing the iRIS-2400 module.** To remove the iRIS-2400 module, push both handles outward. The module is ejected by a mechanism in the socket.

**NOTE:**

After installing the iRIS-2400 module, use **LAN1\_USB2** port to establish a network connection. Please refer to **Section 4.8** for IPMI setup procedures.

---

## 4.4 mSATA Card Installation

To install an mSATA card, please follow the steps below.

**Step 1: Locate the mSATA card slot.** The location of the mSATA card slot is shown in **Chapter 3**.

**Step 2: Remove the retention screws.** Remove the two retention screws secured on the motherboard as shown in **Figure 4-8**.

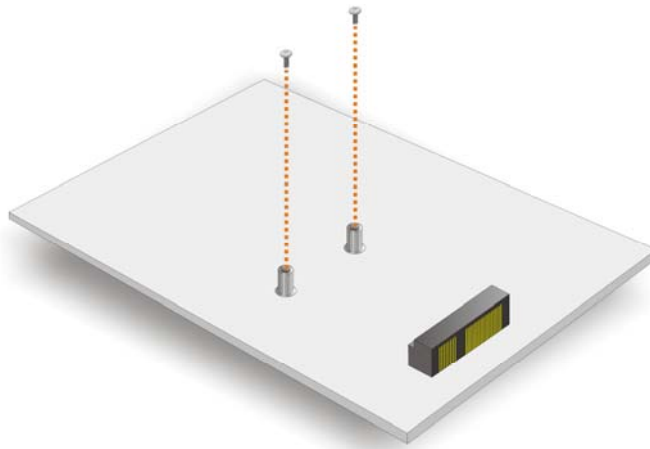

**Figure 4-8: Remove the Retention Screws for the mSATA Card**

**Step 3: Insert into the socket at an angle.** Line up the notch on the card with the notch on the connector. Slide the mSATA card into the socket at an angle of about 20° (**Figure 4-9**).

## IMBA-C2260-i2 ATX Motherboard

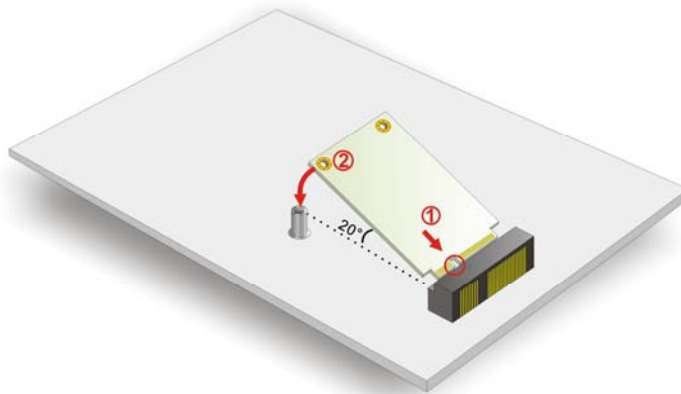

Figure 4-9: Insert the mSATA Card into the Socket at an Angle

**Step 4:** **Secure the mSATA card.** Secure the mSATA card with the retention screws previously removed (Figure 4-10).

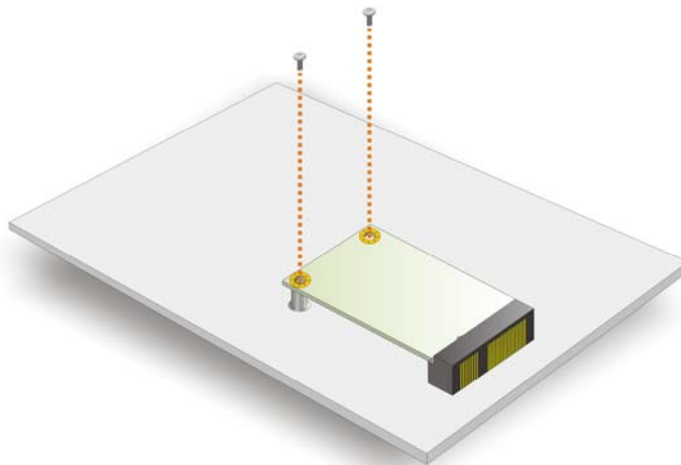

Figure 4-10: Secure the mSATA Card



## 4.5 System Configuration

The system configuration should be performed before installation.

### 4.5.1 AT/ATX Power Mode Setting

The AT and ATX power mode selection is made through the AT/ATX power mode switch which is shown in **Figure 4-11**.

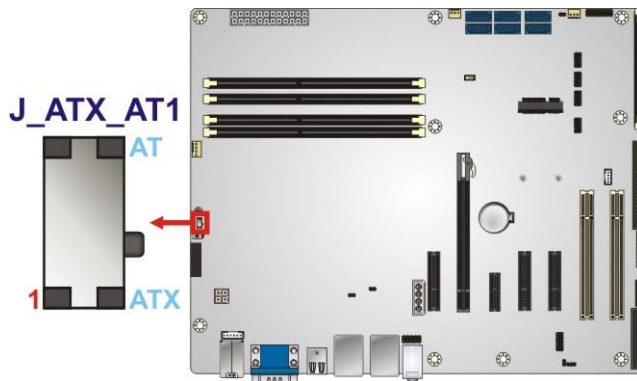

**Figure 4-11: AT/ATX Power Mode Switch Location**

| Setting | Description              |
|---------|--------------------------|
| 1-2     | ATX power mode (default) |
| 2-3     | AT power mode            |

**Table 4-1: AT/ATX Power Mode Switch Settings**

### 4.5.2 Clear CMOS Button

To reset the BIOS, remove the on-board battery and press the clear CMOS button for three seconds or more. The clear CMOS button location is shown in **Figure 4-12**.

## IMBA-C2260-i2 ATX Motherboard



Figure 4-12: Clear CMOS Button Location

### 4.5.3 Flash Descriptor Security Override

The Flash Descriptor Security Override jumper specifies whether to override the flash descriptor.

| Setting   | Description           |
|-----------|-----------------------|
| Short 1-2 | No override (default) |
| Short 2-3 | Override              |

Table 4-2: Flash Descriptor Security Override Jumper Settings

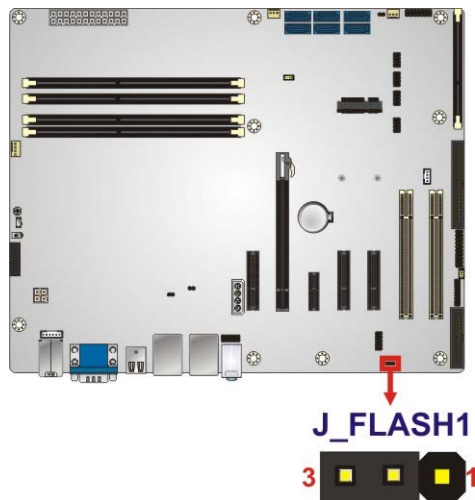

Figure 4-13: Flash Descriptor Security Override Jumper Location

### 4.5.4 mSATA Slot Setup

The mSATA Slot Setup jumper specifies whether to automatically detect the mSATA device installed in the mSATA card slot (CN2). If the user shorts the mSATA Slot Setup jumper to force the system to enable mSATA device, the S\_ATA6 connector will be disabled.

| Setting   | Description   |
|-----------|---|
| Open      | Automatically detect mSATA device (Default)                             |
| Short 1-2 | Force to enable mSATA device<br>(The S_ATA6 connector will be disabled) |

**Table 4-3: mSATA Slot Setup Jumper Settings**

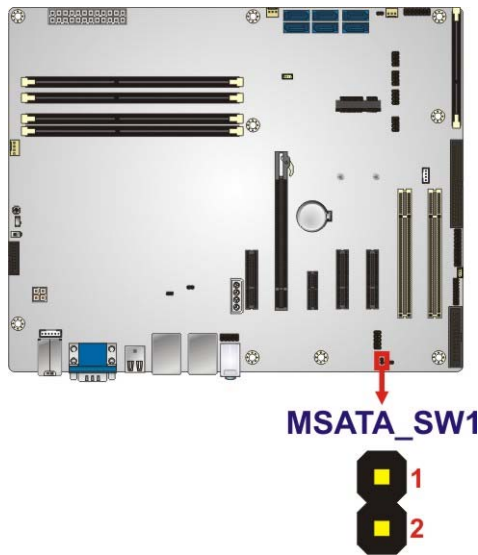

**Figure 4-14: mSATA Slot Setup Jumper Location**

### 4.5.5 PCIe x16 Interface Setup

The PCIe x16 interface setup is made through the BIOS menu in “Chipset → PCH-IO Configuration”. Use the **PEG port configuration** BIOS option to configure the PCIe x16 channel mode.

## IMBA-C2260-i2 ATX Motherboard

| Options         | Description  |
|-----------------|--|
| 1 x16 PCIE      | Sets the PCIe x16 slot as one PCIe x16                         |
| 2 x8 PCIE       | Sets the PCIe x16 slot as two PCIe x8                          |
| 1 x8, 2 x4 PCIE | Sets the PCIe x16 slot as one PCIe x8 or two PCIe x4 (default) |

**Table 4-4: PCIe x16 Interface Setup**



**NOTE:**

When setting to **1 x16 PCIE** option, the PCIEX4\_2 and PCIEX4\_3 slots will be disabled.

Please refer to **Section 5.4.1** for detailed information.

### 4.5.6 USB Power Selection

The USB power selection is made through the BIOS menu in “Chipset → PCH-IO Configuration”. Use the **USB Power SW1** and the **USB Power SW2** BIOS options to configure the correspondent USB ports (see **Table 4-5**) and refer to **Table 4-6** to select the USB power source.

| BIOS Options  | Configured USB Ports   |
|---------------|--|
| USB Power SW1 | K/M_USB1 (external USB 2.0 ports)<br>LAN1_USB1 (external USB 3.0 ports)                              |
| USB Power SW2 | USB1 (internal USB 2.0 ports)<br>USB2 (internal USB 2.0 ports)<br>LAN1_USB2 (external USB 3.0 ports) |

**Table 4-5: BIOS Options and Configured USB Ports**

| Options  | Description        |
|----------|--------------------|
| +5V DUAL | +5V dual (default) |
| +5V      | +5V                |

**Table 4-6: USB Power Source Setup**

Please refer to **Section 5.4.1** for detailed information.

## 4.6 Internal Peripheral Device Connections

This section outlines the installation of peripheral devices to the onboard connectors.

### 4.6.1 SATA Drive Connection

The IMBA-C2260-i2 is shipped with two SATA drive cables. To connect the SATA drives to the connectors, please follow the steps below.

**Step 1: Locate the connectors.** The locations of the SATA drive connectors are shown in **Chapter 3**.

**Step 2: Insert the cable connector.** Insert the cable connector into the on-board SATA drive connector until it clips into place. See **Figure 4-15**.

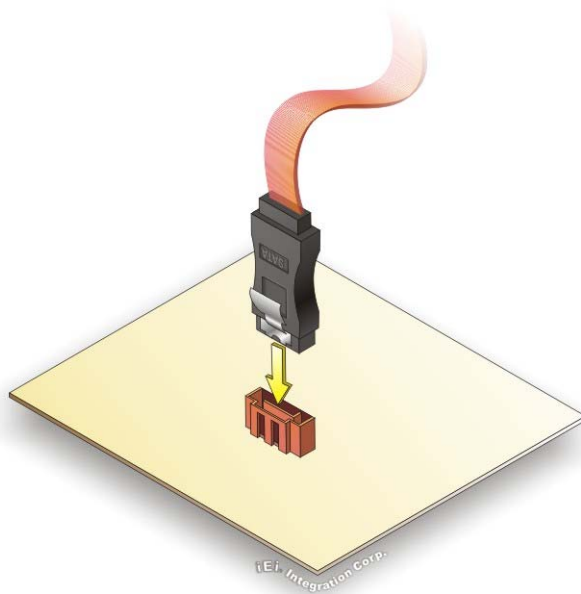
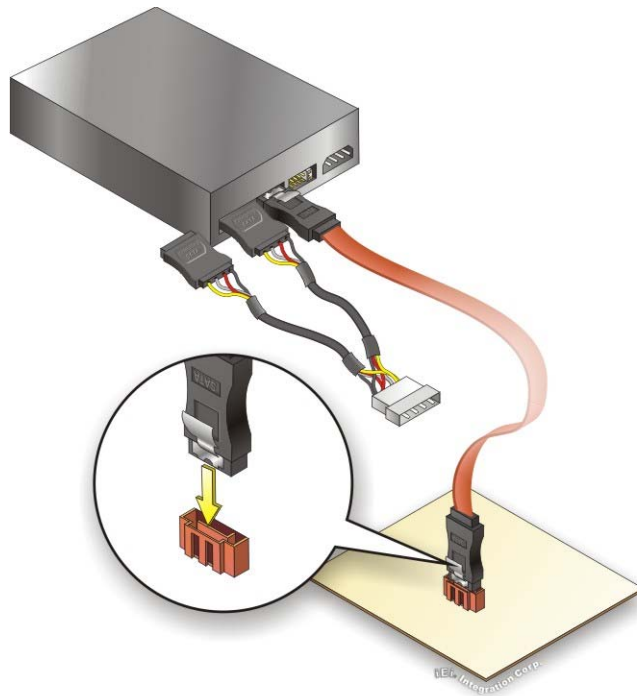

**Figure 4-15: SATA Drive Cable Connection**

**Step 3: Connect the cable to the SATA disk.** Connect the connector on the other end of the cable to the connector at the back of the SATA drive. See **Figure 4-16**.

**Step 4: Connect the SATA power cable.** Connect the SATA power connector to the back of the SATA drive. See **Figure 4-16**.

## IMBA-C2260-i2 ATX Motherboard



**Figure 4-16: SATA Power Drive Connection**

The SATA power cable can be bought from IEI. See Optional Items in Section 2.4.

### 4.7 Intel® AMT Setup Procedure

The IMBA-C2260-i2 is featured with the Intel® Active Management Technology (AMT). To enable the Intel® AMT function, follow the steps below.

- Step 1:** Make sure at least one of the memory sockets is installed with a DDR3 DIMM.
- Step 2:** Connect an Ethernet cable to the RJ-45 connector labeled **LAN1\_USB1**.
- Step 3:** The AMI BIOS options regarding the Intel® ME or Intel® AMT must be enabled,
- Step 4:** Properly install the Intel® Management Engine Components drivers from the iAMT Driver & Utility directory in the driver CD. See **Section 6.8**.
- Step 5:** Configure the Intel® Management Engine BIOS extension (MEBx). To get into the Intel® MEBx settings, press <Ctrl+P> after a single beep during boot-up process. Enter the Intel® current ME password as it requires (the Intel® default password is **admin**).

**NOTE:**

To change the password, enter a new password following the strong password rule (containing at least one upper case letter, one lower case letter, one digit and one special character, and be at least eight characters).

## 4.8 IPMI Setup Procedure

The IMBA-C2260-i2 features Intelligent Platform Management Interface (IPMI) that helps lower the overall costs of server management by enabling users to maximize IT resources, save time and manage multiple systems. The IMBA-C2260-i2 supports IPMI 2.0 through the optional iRIS-2400 module. Follow the steps below to setup IPMI.

### 4.8.1 Managed System Hardware Setup

The hardware configuration of the managed system (IMBA-C2260-i2) is described below.

**Step 1:** Install an iRIS-2400 module to the IPMI module socket (refer to **Section 4.3**).

**Step 2:** Make sure at least one DDR3 DIMM is installed in one of the DIMM sockets. If multiple DIMMs are installed, all of the DIMMs must be same size, same speed and same brand to get the best performance.

**Step 3:** Connect an Ethernet cable to the RJ-45 connector labeled **LAN1\_USB2** (**Figure 3-34**).

### 4.8.2 Using the IEI iMAN Web GUI

To manage a client system from a remote console using IEI iMAN Web GUI, follow the steps below.

**Step 1:** Obtain the IP address of the managed system. It is recommended to use the IPMI Tool on the managed system to obtain the IP address. To use IPMI Tool to obtain IP address, follow the steps below:

## IMBA-C2260-i2 ATX Motherboard

- a. Copy the **Ipmitool.exe** file to a bootable USB flash drive.
- b. Insert the USB flash drive to the IMBA-C2260-i2
- c. The IMBA-C2260-i2 boots from the USB flash drive
- d. Enter the following command: **ipmitool 20 30 02 01 03 00 00**  
(there is a space between each two-digit number)
- e. A serial of number shows. The last four two-digit hexadecimal numbers are the IP address. Convert the hexadecimal numbers to decimal numbers.

**Step 2:** On the remote management console, open a web browser. Enter the managed system IP address in the web browser (**Figure 4-17**).

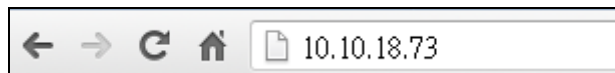

**Figure 4-17: IEI iMAN Web Address**

- Step 3:** The login page appears in the web browser.
- Step 4:** Enter the user name and password to login the system. The default login username and password are:
- Username: **admin**
  - Password: **admin**
- Step 5:** Press the login button to login the system.
- Step 6:** The IEI iMAN Web Interface appears.



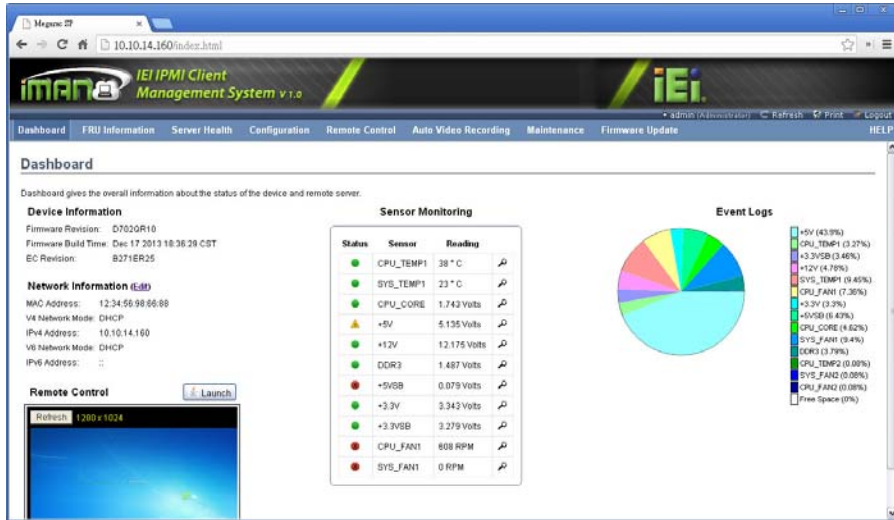

**Figure 4-18: IEI iMAN Web GUI**



**NOTE:**

To understand how to use the IEI iMAN Web GUI, please refer to the iRIS-2400 Web GUI user manual in the utility CD came with the IMBA-C2260-i2. The user manual describes each function in detail.

Chapter

**5**

# **BIOS**

---

## 5.1 Introduction

The BIOS is programmed onto the BIOS chip. The BIOS setup program allows changes to certain system settings. This chapter outlines the options that can be changed.



### NOTE:

Some of the BIOS options may vary throughout the life cycle of the product and are subject to change without prior notice.

---

### 5.1.1 Starting Setup

The UEFI BIOS is activated when the computer is turned on. The setup program can be activated in one of two ways.

1. Press the **DEL** or **F2** key as soon as the system is turned on or
2. Press the **DEL** or **F2** key when the “**Press DEL or F2 to enter SETUP**” message appears on the screen.

If the message disappears before the **DEL** or **F2** key is pressed, restart the computer and try again.

### 5.1.2 Using Setup

Use the arrow keys to highlight items, press **ENTER** to select, use the PageUp and PageDown keys to change entries, press **F1** for help and press **ESC** to quit. Navigation keys are shown in **Table 5-1**.

| Key         | Function                                   |
|-------------|--|
| Up arrow    | Move to previous item                      |
| Down arrow  | Move to next item                          |
| Left arrow  | Move to the item on the left hand side     |
| Right arrow | Move to the item on the right hand side    |
| +           | Increase the numeric value or make changes |

## IMBA-C2260-i2 ATX Motherboard

| Key     | Function   |
|---------|--|
| -       | Decrease the numeric value or make changes   |
| Page Up | Move to the previous page  |
| Page Dn | Move to the next page  |
| Esc     | Main Menu – Quit and not save changes into CMOS<br>Status Page Setup Menu and Option Page Setup Menu --<br>Exit current page and return to Main Menu |
| F1      | General help, only for Status Page Setup Menu and Option<br>Page Setup Menu  |
| F2      | Load previous values   |
| F3      | Load optimized defaults  |
| F4      | Save changes and Exit BIOS   |

Table 5-1: BIOS Navigation Keys

### 5.1.3 Getting Help

When **F1** is pressed a small help window describing the appropriate keys to use and the possible selections for the highlighted item appears. To exit the Help Window press **Esc** or the **F1** key again.

### 5.1.4 Unable to Reboot after Configuration Changes

If the computer cannot boot after changes to the system configuration is made, CMOS defaults. Use the clear CMOS button described in Chapter 4.

### 5.1.5 BIOS Menu Bar

The **menu bar** on top of the BIOS screen has the following main items:

- Main – Changes the basic system configuration.
- Advanced – Changes the advanced system settings.
- Chipset – Changes the chipset settings.
- Boot – Changes the system boot configuration.

- Security – Sets User and Supervisor Passwords.
- Save & Exit – Selects exit options and loads default settings

The following sections completely describe the configuration options found in the menu items at the top of the BIOS screen and listed above.

## IMBA-C2260-i2 ATX Motherboard

### 5.2 Main

The **Main** BIOS menu (**BIOS Menu 1**) appears when the **BIOS Setup** program is entered.

The **Main** menu gives an overview of the basic system information.

| Aptio Setup Utility - Copyright (C) 2012 American Megatrends, Inc. |          |         |                          |          |             |  |
|--|----------|---------|--------------------------|----------|-------------|--|
| Main   | Advanced | Chipset | Boot                     | Security | Save & Exit | Server Mgmt  |
| BIOS Information   |          |         |                          |          |             | Set the Date. Use Tab to switch between Data elements. |
| BIOS Vendor  |          |         | American Megatrends      |          |             |  |
| Core Version   |          |         | 4.6.5.4                  |          |             |  |
| Compliance   |          |         | UEFI 2.3.1; PI 1.2       |          |             |  |
| Project Version  |          |         | B269AR32.ROM             |          |             |  |
| Build Date and Time  |          |         | 10/08/2014 11:53:40      |          |             |  |
| iWDD Vendor  |          |         | iEi                      |          |             |  |
| iWDD Version   |          |         | B269ER27.bin             |          |             |  |
| IPMI Module  |          |         | iRIS-2100                |          |             |  |
| Processor Information  |          |         |                          |          |             |  |
| Name   |          |         | Haswell                  |          |             |  |
| Brand String   |          |         | Intel(R) Core(TM) i3-433 |          |             |  |
| Frequency  |          |         | 3500 MHz                 |          |             |  |
| Processor ID   |          |         | 306c3                    |          |             |  |
| Stepping   |          |         | C0                       |          |             |  |
| Number of Processors   |          |         | 2Core(s) / 4Thread(s)    |          |             |  |
| Microcode Revision   |          |         | 17                       |          |             |  |
| GT Info  |          |         | GT2 (700 MHz)            |          |             |  |
| IGFX VBIOS Version   |          |         | 2164                     |          |             |  |
| Memory RC Version  |          |         | 1.6.2.1                  |          |             |  |
| Total Memory   |          |         | 2048 MB (DDR3)           |          |             |  |
| Memory Frequency   |          |         | 1333 MHz                 |          |             |  |
| PCH Information  |          |         |                          |          |             |  |
| Name   |          |         | LynxPoint                |          |             | →←: Select Screen                                      |
| PCH SKU  |          |         | C226                     |          |             | ↑ ↓: Select Item                                       |
| Stepping   |          |         | 05/C2                    |          |             | Enter: Select  |
| LAN PHY Revision   |          |         | A3                       |          |             | +/-: Change Opt.                                       |
| ME FW Version  |          |         | 9.1.2.1010               |          |             | F1: General Help                                       |
| ME Firmware SKU  |          |         | 5MB                      |          |             | F2: Previous Values                                    |
| SPI Clock Frequency  |          |         |                          |          |             | F3: Optimized Defaults                                 |
| DOFR Support   |          |         | Supported                |          |             | F4: Save & Exit  |
| Read Status Clock Frequency  |          |         | 50 MHz                   |          |             | ESC: Exit  |
| Write Status Clock Frequency                                       |          |         | 50 MHz                   |          |             |  |
| Fast Read Status Clock Frequency                                   |          |         | 50 MHz                   |          |             |  |
| System Date  |          |         | [Wed 11/26/2014]         |          |             |  |
| System Time  |          |         | [15:10:27]               |          |             |  |
| Access Level   |          |         | Administrator            |          |             |  |
| Version 2.15.1236. Copyright (C) 2012 American Megatrends, Inc.    |          |         |                          |          |             |  |

**BIOS Menu 1: Main**

The **Main** menu has two user configurable fields:

→ **System Date [xx/xx/xx]**

Use the **System Date** option to set the system date. Manually enter the day, month and year.

→ **System Time [xx:xx:xx]**

Use the **System Time** option to set the system time. Manually enter the hours, minutes and seconds.

### 5.3 Advanced

Use the **Advanced** menu (**BIOS Menu 2**) to configure the CPU and peripheral devices through the following sub-menus:



#### WARNING!

Setting the wrong values in the sections below may cause the system to malfunction. Make sure that the settings made are compatible with the hardware.

```

Aptio Setup Utility - Copyright (C) 2012 American Megatrends, Inc.
Main  Advanced  Chipset  Boot  Security  Save & Exit  Server Mgmt
-----
> ACPI Settings
> RTC Wake Settings
> Trusted Computing
> CPU Configuration
> SATA Configuration
> Intel(R) Rapid Start Technology
> AMT Configuration
> USB Configuration
> F81866 Super IO Configuration
> iWDD H/M Monitor
> Serial Port Console Redirection
> iEi Feature

System ACPI Parameters
-----
→←: Select Screen
↑↓: Select Item
Enter: Select
+/-: Change Opt.
F1: General Help
F2: Previous Values
F3: Optimized Defaults
F4: Save & Exit
ESC: Exit

Version 2.15.1236. Copyright (C) 2012 American Megatrends, Inc.
    
```

**BIOS Menu 2: Advanced**

## IMBA-C2260-i2 ATX Motherboard

### 5.3.1 ACPI Settings

The **ACPI Settings** menu (**BIOS Menu 3**) configures the Advanced Configuration and Power Interface (ACPI) options.

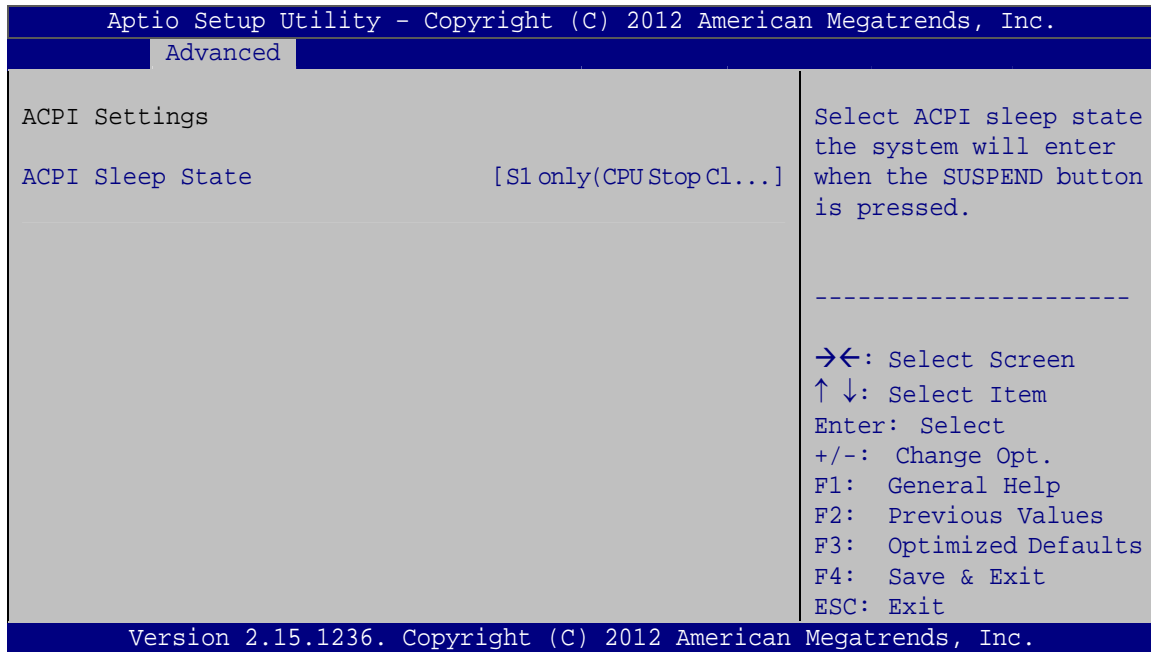

#### BIOS Menu 3: ACPI Configuration

##### → **ACPI Sleep State [S1 only (CPU Stop Cl...)]**

Use the **ACPI Sleep State** option to specify the sleep state the system enters when it is not being used.

- **S1 only (CPU Stop Clock)** **DEFAULT** The system enters S1(POS) sleep state. The system appears off. The CPU is stopped; RAM is refreshed; the system is running in a low power mode.
- **S3 only (Suspend to RAM)** The caches are flushed and the CPU is powered off. Power to the RAM is maintained. The computer returns slower to a working state, but more power is saved.



### 5.3.2 RTC Wake Settings

The **RTC Wake Settings** menu (**BIOS Menu 4**) enables the system to wake at the specified time.

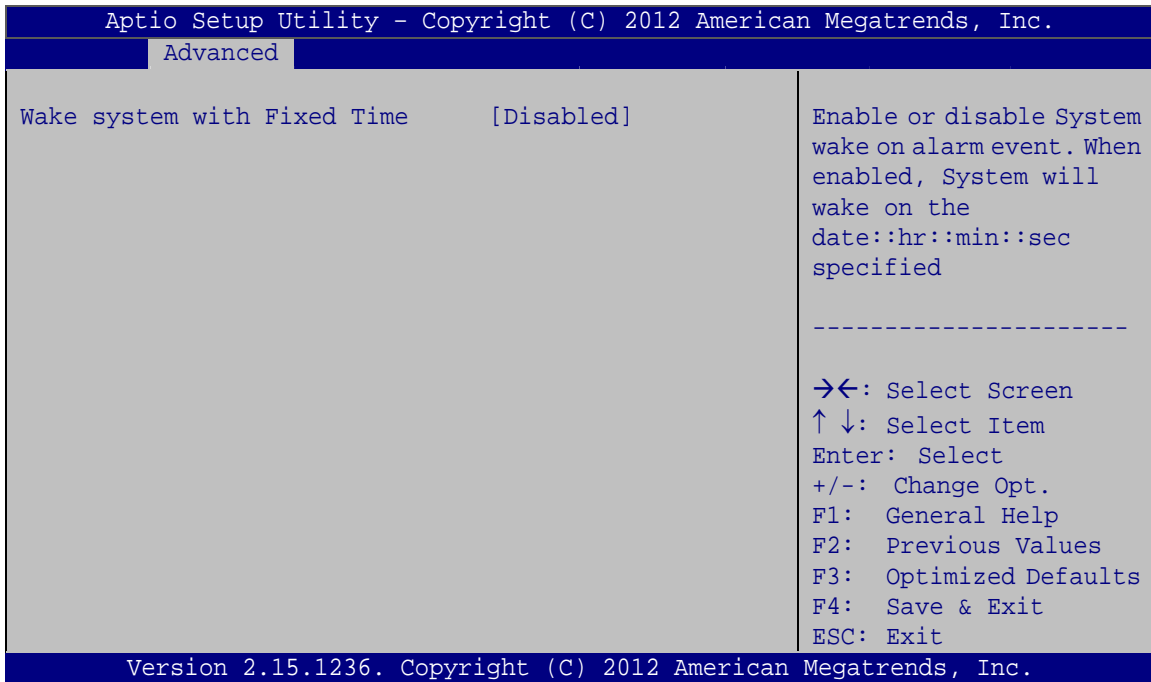

#### BIOS Menu 4: RTC Wake Settings

##### → Wake system with Fixed Time [Disabled]

Use the **Wake system with Fixed Time** option to enable or disable the system wake on alarm event.

- **Disabled**      **DEFAULT**      The real time clock (RTC) cannot generate a wake event
  
- **Enabled**      If selected, the **Wake up every day** option appears allowing you to enable to disable the system to wake every day at the specified time. Besides, the following options appear with values that can be selected:

Wake up date

Wake up hour

## IMBA-C2260-i2 ATX Motherboard

Wake up minute

Wake up second

After setting the alarm, the computer turns itself on from a suspend state when the alarm goes off.

### 5.3.3 Trusted Computing

Use the **Trusted Computing** menu (**BIOS Menu 5**) to configure settings related to the Trusted Computing Group (TCG) Trusted Platform Module (TPM).

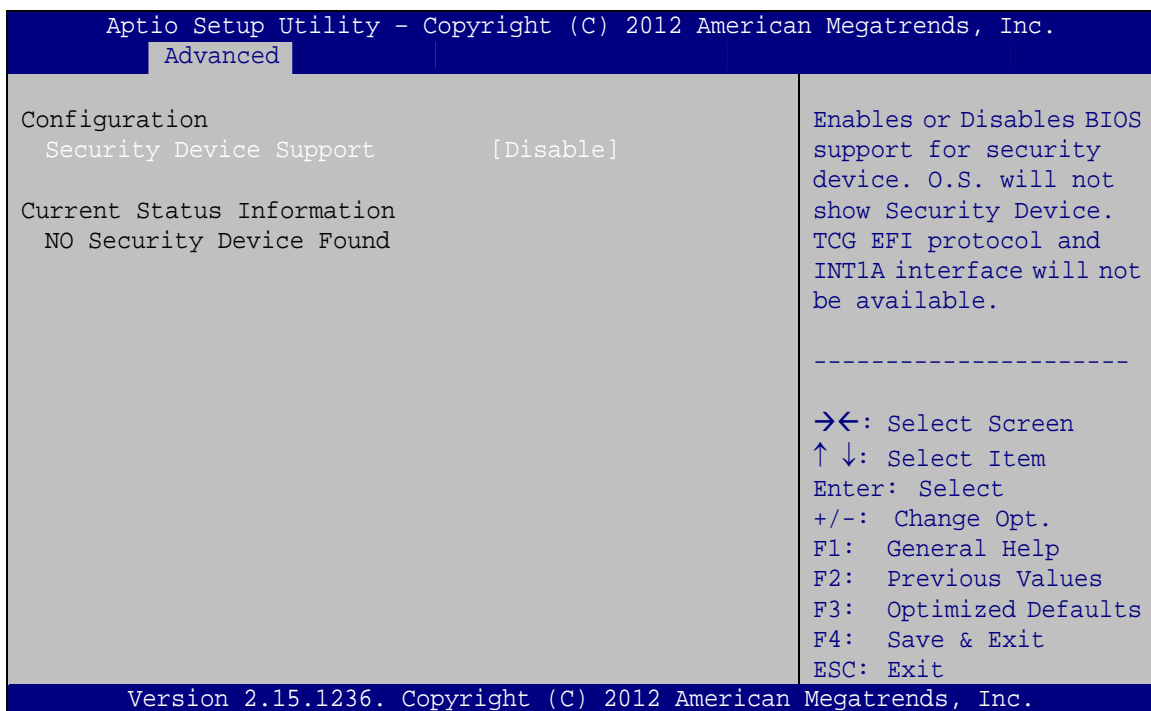

#### BIOS Menu 5: Trusted Computing

##### → Security Device Support [Disable]

Use the **Security Device Support** option to configure support for the TPM.

→ **Disable** **DEFAULT** TPM support is disabled.

→ **Enable** TPM support is enabled.

### 5.3.4 CPU Configuration

Use the **CPU Configuration** menu (**BIOS Menu 6**) to view detailed CPU specifications or enable the Intel Virtualization Technology.

```

Aptio Setup Utility - Copyright (C) 2012 American Megatrends, Inc.
  Advanced
CPU Configuration
Intel(R) Core(TM) i3-4330 CPU @ 3.50GHz
CPU Signature          306c3
Microcode Patch       17
Max CPU Speed         3500 MHz
Min CPU Speed         800 MHz
CPU Speed             3500 MHz
Processor Cores       2
Intel HT Technology   Supported
Intel VT-x Technology Supported
Intel SMX Technology  Not Supported
64-bit               Supported
EIST Technology       Supported

L1 Data Cache        32 kB x 2
L1 Code Cache        32 kB x 2
L2 Cache             256 kB x 2
L3 Cache             4096 kB

Hyper-threading      [Enabled]
Active Processor Cores [All]
Intel Virtualization Technology [Disabled]
EIST                 [Enabled]

-----
-><: Select Screen
↑↓: Select Item
Enter: Select
+/-: Change Opt.
F1:  General Help
F2:  Previous Values
F3:  Optimized Defaults
F4:  Save & Exit
ESC: Exit

Version 2.15.1236. Copyright (C) 2012 American Megatrends, Inc.
    
```

#### BIOS Menu 6: CPU Configuration

##### → Hyper-threading [Enabled]

Use the **Hyper-threading** BIOS option to enable or disable the Intel Hyper-Threading Technology.

- **Disabled**                      Disables the Intel Hyper-Threading Technology.
- **Enabled**    **DEFAULT**      Enables the Intel Hyper-Threading Technology.

## IMBA-C2260-i2 ATX Motherboard

### → Active Processor Cores [All]

Use the **Active Processor Cores** BIOS option to enable numbers of cores in the processor package.

- **All**                      **DEFAULT**      Enable all cores in the processor package.
- **1**    Enable one core in the processor package.

### → Intel Virtualization Technology [Disabled]

Use the **Intel Virtualization Technology** option to enable or disable virtualization on the system. When combined with third party software, Intel® Virtualization technology allows several OSs to run on the same system at the same time.

- **Disabled**                      **DEFAULT**      Disables Intel Virtualization Technology.
- **Enabled**    Enables Intel Virtualization Technology.

### → EIST [Enabled]

Use the **EIST** option to enable or disable the Enhanced Intel® SpeedStep Technology (EIST).

- **Disabled**    Disables Enhanced Intel® SpeedStep Technology
- **Enabled**                      **DEFAULT**      Enables Enhanced Intel® SpeedStep Technology

### 5.3.5 SATA Configuration

Use the **SATA Configuration** menu (**BIOS Menu 7**) to change and/or set the configuration of the SATA devices installed in the system.

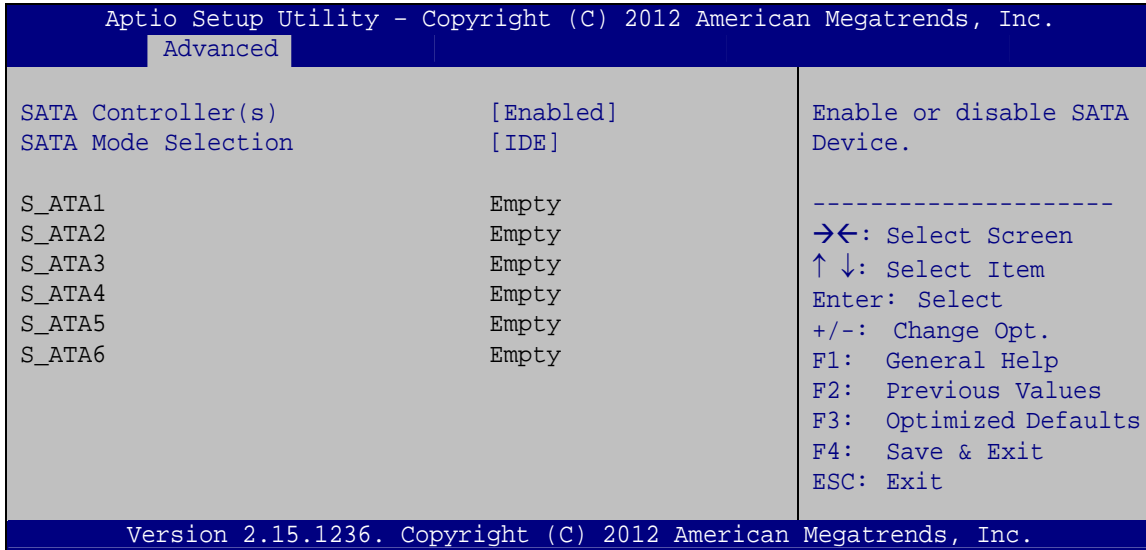

#### BIOS Menu 7: SATA Configuration

##### → SATA Controller(s) [Enabled]

Use the **SATA Controller(s)** option to configure the SATA controller(s).

- **Enabled**      **DEFAULT**      Enables the on-board SATA controller(s).
- **Disabled**                      Disables the on-board SATA controller(s).

##### → SATA Mode Selection [IDE]

Use the **SATA Mode Selection** option to configure SATA devices as normal IDE devices.

- **IDE**              **DEFAULT**      Configures SATA devices as normal IDE device.
- **AHCI**                              Configures SATA devices as AHCI device.
- **RAID**                              Configures SATA devices as RAID device.

## IMBA-C2260-i2 ATX Motherboard

### 5.3.6 Intel(R) Rapid Start Technology

Use the **Intel(R) Rapid Start Technology (BIOS Menu 8)** menu to configure Intel® Rapid Start Technology support.

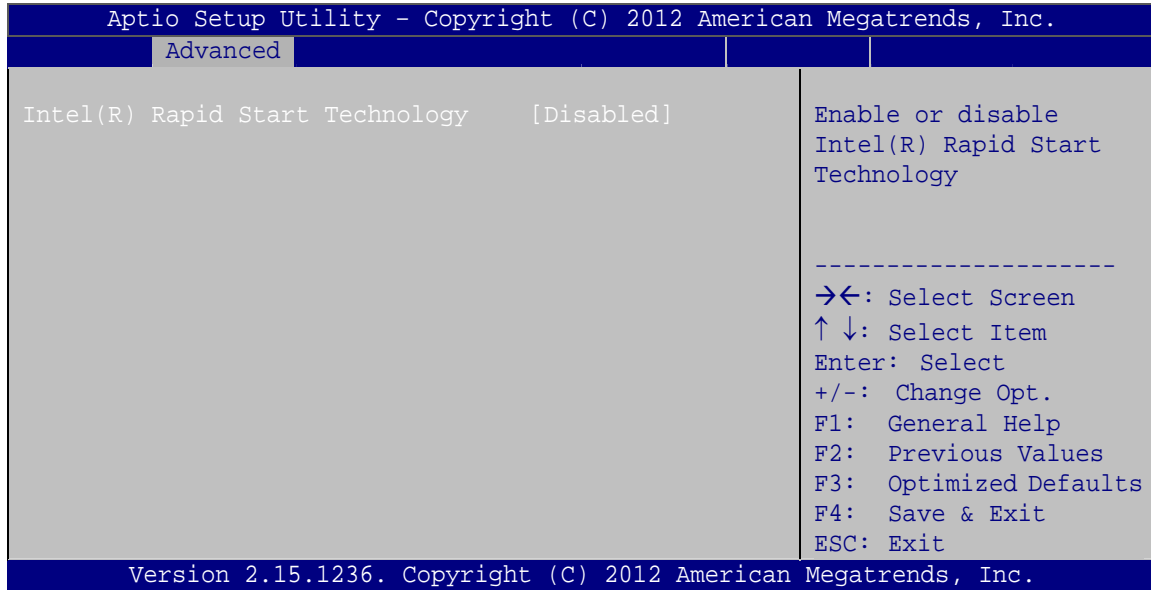

#### BIOS Menu 8: Intel(R) Rapid Start Technology

##### → Intel(R) Rapid Start Technology [Disabled]

Use **Intel(R) Rapid Start Technology** option to enable or disable the Intel® Rapid Start Technology function.

- **Disabled**      **DEFAULT**      Intel® Rapid Start Technology is disabled
- **Enabled**                      Intel® Rapid Start Technology is enabled

### 5.3.7 AMT Configuration

The **AMT Configuration** menu (**BIOS Menu 9**) allows the Intel® AMT options to be configured.

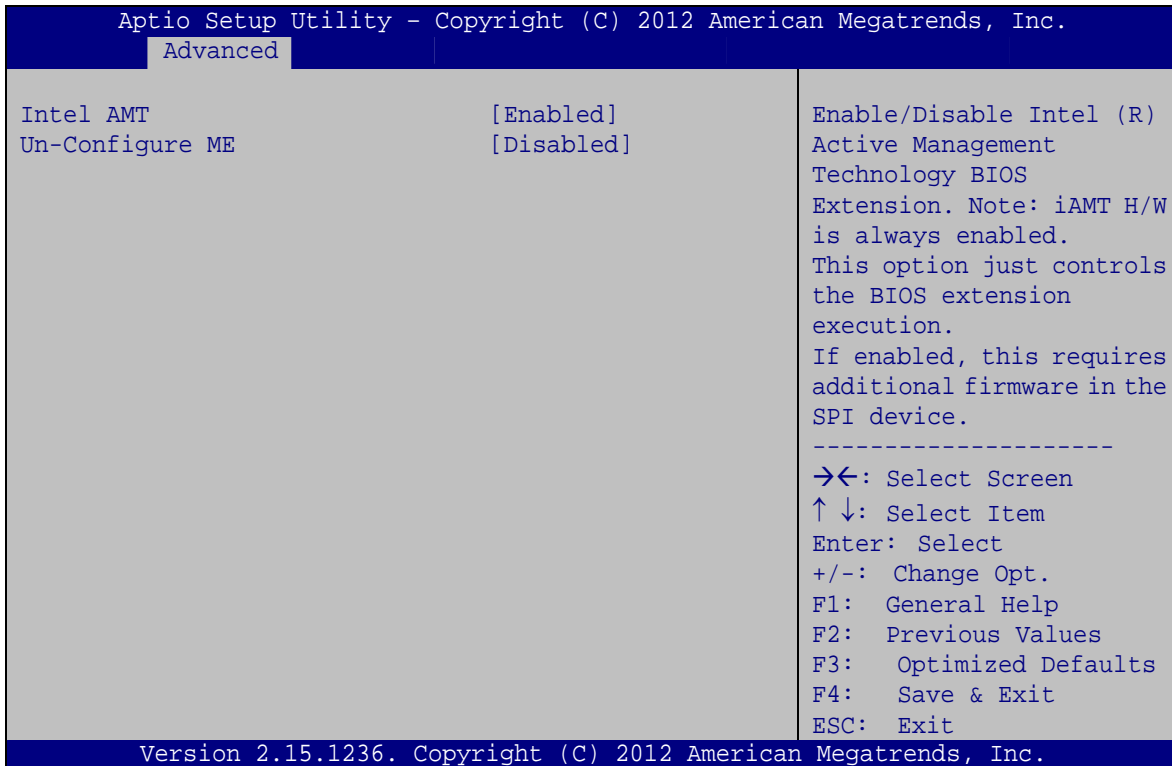

#### BIOS Menu 9: AMT Configuration

##### → Intel AMT [Enabled]

Use **Intel AMT** option to enable or disable the Intel® AMT function.

- **Disabled** Intel® AMT is disabled
- **Enabled** **DEFAULT** Intel® AMT is enabled

##### → Un-Configure ME [Disabled]

Use the **Un-Configure ME** option to perform ME unconfigure without password operation.

- **Disabled** **DEFAULT** Not perform ME unconfigure
- **Enabled** To perform ME unconfigure

## IMBA-C2260-i2 ATX Motherboard

### 5.3.8 USB Configuration

Use the **USB Configuration** menu (**BIOS Menu 10**) to read USB configuration information and configure the USB settings.

```

Aptio Setup Utility - Copyright (C) 2012 American Megatrends, Inc.
  Advanced
-----
USB Configuration
USB Devices:
  1 Keyboard, 1 Mouse, 2 Hubs
Legacy USB Support          [Enabled]
-----
-><: Select Screen
↑↓: Select Item
Enter: Select
+/-: Change Opt.
F1: General Help
F2: Previous Values
F3: Optimized Defaults
F4: Save & Exit
ESC: Exit
-----
Version 2.15.1236. Copyright (C) 2012 American Megatrends, Inc.

```

#### BIOS Menu 10: USB Configuration

##### → USB Devices

The **USB Devices** field lists the USB devices that are enabled on the system

##### → Legacy USB Support [Enabled]

Use the **Legacy USB Support** BIOS option to enable USB mouse and USB keyboard support. Normally if this option is not enabled, any attached USB mouse or USB keyboard does not become available until a USB compatible operating system is fully booted with all USB drivers loaded. When this option is enabled, any attached USB mouse or USB keyboard can control the system even when there is no USB driver loaded onto the system.



- ➔ **Enabled**      **DEFAULT**      Legacy USB support enabled
- ➔ **Disabled**                      Legacy USB support disabled
- ➔ **Auto**                              Legacy USB support disabled if no USB devices are connected

### 5.3.9 F81866 Super IO Configuration

Use the **F81866 Super IO Configuration** menu (**BIOS Menu 11**) to set or change the configurations for the parallel ports and serial ports.

```

Aptio Setup Utility - Copyright (C) 2012 American Megatrends, Inc.
  Advanced
F81866 Super IO Configuration
F81866 Super IO Chip          F81866
> Serial Port 1 Configuration
> Serial Port 2 Configuration
> Serial Port 3 Configuration
> Serial Port 4 Configuration
> Serial Port 5 Configuration
> Serial Port 6 Configuration
> Parallel Port Configuration

Set Parameters of Serial
Port 1 (COMA)
-----
-><: Select Screen
↑↓: Select Item
Enter: Select
+/-: Change Opt.
F1: General Help
F2: Previous Values
F3: Optimized Defaults
F4: Save & Exit
ESC: Exit

Version 2.15.1236. Copyright (C) 2012 American Megatrends, Inc.
  
```

**BIOS Menu 11: F81866 Super IO Configuration**

## IMBA-C2260-i2 ATX Motherboard

### 5.3.9.1 Serial Port n Configuration

Use the **Serial Port n Configuration** menu (**BIOS Menu 12**) to configure the serial port n.

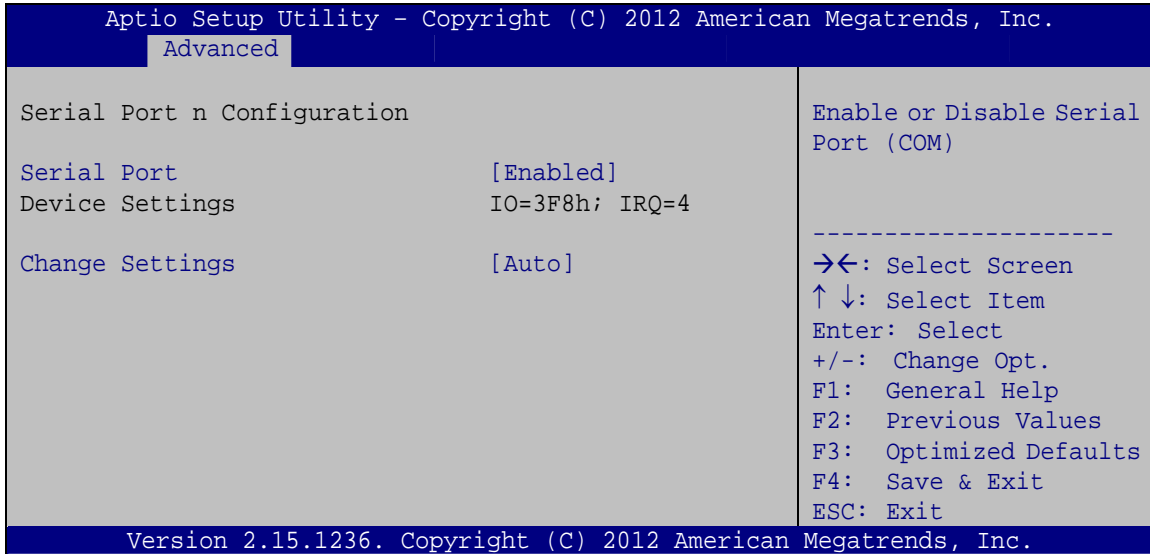

#### BIOS Menu 12: Serial Port n Configuration Menu

#### 5.3.9.1.1 Serial Port 1 Configuration

##### → Serial Port [Enabled]

Use the **Serial Port** option to enable or disable the serial port.

- **Disabled**                      Disable the serial port
- **Enabled**            **DEFAULT**      Enable the serial port

##### → Change Settings [Auto]

Use the **Change Settings** option to change the serial port IO port address and interrupt address.

- **Auto**            **DEFAULT**      The serial port IO port address and interrupt address are automatically detected.
- **IO=3F8h;**  
**IRQ=4**                      Serial Port I/O port address is 3F8h and the interrupt address is IRQ4

- **IO=3F8h;**  
**IRQ=3, 4**                      Serial Port I/O port address is 3F8h and the interrupt address is IRQ3, 4
- **IO=2C0h;**  
**IRQ=3, 4**                      Serial Port I/O port address is 2C0h and the interrupt address is IRQ3, 4
- **IO=2C8h;**  
**IRQ=3, 4**                      Serial Port I/O port address is 2C8h and the interrupt address is IRQ3, 4

### 5.3.9.1.2 Serial Port 2 Configuration

#### → Serial Port [Enabled]

Use the **Serial Port** option to enable or disable the serial port.

- **Disabled**                      Disable the serial port
- **Enabled**                      **DEFAULT**                      Enable the serial port

#### → Change Settings [Auto]

Use the **Change Settings** option to change the serial port IO port address and interrupt address.

- **Auto**                      **DEFAULT**                      The serial port IO port address and interrupt address are automatically detected.
- **IO=2F8h;**  
**IRQ=3**                      Serial Port I/O port address is 2F8h and the interrupt address is IRQ3
- **IO=3F8h;**  
**IRQ=3, 4**                      Serial Port I/O port address is 3F8h and the interrupt address is IRQ3, 4
- **IO=2F8h;**  
**IRQ=3, 4**                      Serial Port I/O port address is 2F8h and the interrupt address is IRQ3, 4
- **IO=2C0h;**  
**IRQ=3, 4**                      Serial Port I/O port address is 2C0h and the interrupt address is IRQ3, 4
- **IO=2C8h;**  
**IRQ=3, 4**                      Serial Port I/O port address is 2C8h and the interrupt address is IRQ3, 4

## IMBA-C2260-i2 ATX Motherboard

### 5.3.9.1.3 Serial Port 3 Configuration

#### → Serial Port [Enabled]

Use the **Serial Port** option to enable or disable the serial port.

- **Disabled**                      Disable the serial port
- **Enabled**      **DEFAULT**      Enable the serial port

#### → Change Settings [Auto]

Use the **Change Settings** option to change the serial port IO port address and interrupt address.

- **Auto**              **DEFAULT**      The serial port IO port address and interrupt address are automatically detected.
- **IO=2D0h;**  
**IRQ=11**                      Serial Port I/O port address is 2D0h and the interrupt address is IRQ11
- **IO=2D0h;**  
**IRQ=10, 11**                      Serial Port I/O port address is 2D0h and the interrupt address is IRQ10, 11
- **IO=2E8h;**  
**IRQ=10, 11**                      Serial Port I/O port address is 2E8h and the interrupt address is IRQ10, 11
- **IO=2D8h;**  
**IRQ=10, 11**                      Serial Port I/O port address is 2D8h and the interrupt address is IRQ10, 11

### 5.3.9.1.4 Serial Port 4 Configuration

#### → Serial Port [Enabled]

Use the **Serial Port** option to enable or disable the serial port.

- **Disabled**                      Disable the serial port
- **Enabled**      **DEFAULT**      Enable the serial port

### → Change Settings [Auto]

Use the **Change Settings** option to change the serial port IO port address and interrupt address.

- |   |                                |                |   |
|---|--------------------------------|----------------|---|
| → | <b>Auto</b>                    | <b>DEFAULT</b> | The serial port IO port address and interrupt address are automatically detected. |
| → | <b>IO=2E8h;<br/>IRQ=10</b>     |                | Serial Port I/O port address is 2E8h and the interrupt address is IRQ10           |
| → | <b>IO=2E8h;<br/>IRQ=10, 11</b> |                | Serial Port I/O port address is 2E8h and the interrupt address is IRQ10, 11       |
| → | <b>IO=2D0h;<br/>IRQ=10, 11</b> |                | Serial Port I/O port address is 2D0h and the interrupt address is IRQ10, 11       |
| → | <b>IO=2D8h;<br/>IRQ=10, 11</b> |                | Serial Port I/O port address is 2D8h and the interrupt address is IRQ10, 11       |

### → Device Mode [RS422/485]

The serial port 4 is set to RS-422/485 mode.

## 5.3.9.1.5 Serial Port 5 Configuration

### → Serial Port [Enabled]

Use the **Serial Port** option to enable or disable the serial port.

- |   |                 |                |                         |
|---|-----------------|----------------|-------------------------|
| → | <b>Disabled</b> |                | Disable the serial port |
| → | <b>Enabled</b>  | <b>DEFAULT</b> | Enable the serial port  |

### → Change Settings [Auto]

Use the **Change Settings** option to change the serial port IO port address and interrupt address.

- |   |             |                |   |
|---|-------------|----------------|---|
| → | <b>Auto</b> | <b>DEFAULT</b> | The serial port IO port address and interrupt address are automatically detected. |
|---|-------------|----------------|---|

## IMBA-C2260-i2 ATX Motherboard

- **IO=2C0h;**  
**IRQ=11**                      Serial Port I/O port address is 2C0h and the interrupt address is IRQ11
- **IO=2C0h;**  
**IRQ=10, 11**                Serial Port I/O port address is 2C0h and the interrupt address is IRQ10, 11
- **IO=2C8h;**  
**IRQ=10, 11**                Serial Port I/O port address is 2C8h and the interrupt address is IRQ10, 11
- **IO=2D0h;**  
**IRQ=10, 11**                Serial Port I/O port address is 2D0h and the interrupt address is IRQ10, 11
- **IO=2D8h;**  
**IRQ=10, 11**                Serial Port I/O port address is 2D8h and the interrupt address is IRQ10, 11
- **IO=2E0h;**  
**IRQ=10, 11**                Serial Port I/O port address is 2E0h and the interrupt address is IRQ10, 11
- **IO=2E8h;**  
**IRQ=10, 11**                Serial Port I/O port address is 2E8h and the interrupt address is IRQ10, 11

### 5.3.9.1.6 Serial Port 6 Configuration

#### → Serial Port [Enabled]

Use the **Serial Port** option to enable or disable the serial port.

- **Disabled**                      Disable the serial port
- **Enabled      DEFAULT**      Enable the serial port

#### → Change Settings [Auto]

Use the **Change Settings** option to change the serial port IO port address and interrupt address.

- **Auto              DEFAULT**      The serial port IO port address and interrupt address are automatically detected.
- **IO=2D8h;**  
**IRQ=10**                      Serial Port I/O port address is 2D8h and the interrupt address is IRQ10



## IMBA-C2260-i2 ATX Motherboard

- **Disabled**                      Disable the parallel port
- **Enabled**      **DEFAULT**      Enable the parallel port

### → Change Settings [Auto]

Use the **Change Settings** option to change the parallel port IO port address and interrupt address.

- **Auto**              **DEFAULT**      The parallel port IO port address and interrupt address are automatically detected.
- **IO=378h;**  
**IRQ=5**                      Parallel Port I/O port address is 378h and the interrupt address is IRQ5
- **IO=378h;**  
**IRQ=5, 7**                      Parallel Port I/O port address is 378h and the interrupt address is IRQ5, 7
- **IO=278h;**  
**IRQ=5, 7**                      Parallel Port I/O port address is 278h and the interrupt address is IRQ5, 7
- **IO=3BCh;**  
**IRQ=5, 7**                      Parallel Port I/O port address is 3BCh and the interrupt address is IRQ5, 7

### → Device Mode [STD Printer Mode]

Use the **Device Mode** option to select the mode the parallel port operates in. Configuration options are listed below.

- STD Printer Mode                      **Default**
- SPP Mode
- EPP-1.9 and SPP Mode
- EPP-1.7 and SPP Mode
- ECP Mode
- ECP and EPP 1.9 Mode
- ECP and EPP 1.7 Mode



### 5.3.10 iWDD H/W Monitor

The **iWDD H/W Monitor** menu (**BIOS Menu 14**) contains the fan configuration submenu, and displays the system temperature and CPU fan speed.

```

Aptio Setup Utility - Copyright (C) 2012 American Megatrends, Inc.
-----
Advanced
-----
PC Health Status
> Smart Fan Mode Configuration
CPU temperature           :+40 C
System temperature       :+36 C
CPU_FAN1 Speed           :3456 RPM
SYS_FAN1 Speed           :N/A
CPU_CORE                  :N/A
+5V                       :N/A
+12V                      :N/A
DDR                       :N/A
+5VSB                     :+6.120 V
+3.3V                     :N/A
+3.3VSB                   :N/A

Smart Fan Mode Select
-----
-><: Select Screen
↑↓: Select Item
Enter: Select
+/-: Change Opt.
F1: General Help
F2: Previous Values
F3: Optimized Defaults
F4: Save & Exit
ESC: Exit

Version 2.15.1236. Copyright (C) 2012 American Megatrends, Inc.
    
```

#### **BIOS Menu 14: iWDD H/W Monitor**

##### **→ PC Health Status**

The following system parameters and values are shown. The system parameters that are monitored are:

- System Temperatures:
  - CPU Temperature
  - System Temperature
- Fan Speeds:
  - CPU Fan Speed
  - System Fan Speed
- Voltages:
  - CPU\_CORE
  - +5V
  - +12V
  - DDR

## IMBA-C2260-i2 ATX Motherboard

- +5VSB
- +3.3V
- +3.3VSB

### 5.3.10.1 Smart Fan Mode Configuration

Use the **Smart Fan Mode Configuration** submenu (**BIOS Menu 15**) to configure fan 1 temperature and speed settings.

```

Aptio Setup Utility - Copyright (C) 2012 American Megatrends, Inc.
-----
Advanced
-----
Smart Fan Mode Configuration
CPU_FAN1 Smart Fan Control      [Auto Mode]
Fan start temperature           50
Fan off temperature             40
Fan start PWM                   30
Fan slope PWM                   1
SYS_FAN1 Smart Fan Control      [Auto Mode]
Fan start temperature           50
Fan off temperature             40
Fan start PWM                   30
Fan slope PWM                   1

Smart Fan Mode Select
-----
-><: Select Screen
↑↓: Select Item
Enter: Select
+/-: Change Opt.
F1: General Help
F2: Previous Values
F3: Optimized Defaults
F4: Save & Exit
ESC: Exit

Version 2.15.1236. Copyright (C) 2012 American Megatrends, Inc.
  
```

#### BIOS Menu 15: Smart Fan Mode Configuration

##### → CPU\_FAN1 Smart Fan Control/SYS\_FAN1 Smart Fan Control [Auto Mode]

Use the **CPU\_FAN1 Smart Fan Control/SYS\_FAN1 Smart Fan Control** option to configure the CPU/System Smart Fan.

→ **Auto Mode**      **DEFAULT**      The fan adjusts its speed using Auto Mode settings.

→ **Manual Mode**                      The fan spins at the speed set in Manual Mode settings.

##### → Fan start/off temperature

Use the + or – key to change the **Fan start/off temperature** value. Enter a decimal number between 1 and 100.

→ **Fan start PWM**

Use the + or – key to change the **Fan start PWM** value. Enter a decimal number between 1 and 100.

→ **Fan slope PWM**

Use the + or – key to change the **Fan slope PWM** value. Enter a decimal number between 1 and 8.

## IMBA-C2260-i2 ATX Motherboard

### 5.3.11 Serial Port Console Redirection

The **Serial Port Console Redirection** menu (**BIOS Menu 16**) allows the console redirection options to be configured. Console redirection allows users to maintain a system remotely by re-directing keyboard input and text output through the serial port.

```

Aptio Setup Utility - Copyright (C) 2012 American Megatrends, Inc.
  Advanced
COM1
  Console Redirection      [Disabled]      Console Redirection
  > Console Redirection Settings      Enable or Disable

COM2
  Console Redirection      [Disabled]
  > Console Redirection Settings

COM3
  Console Redirection      [Disabled]
  > Console Redirection Settings

COM4
  Console Redirection      [Disabled]
  > Console Redirection Settings

COM5
  Console Redirection      [Disabled]
  > Console Redirection Settings

COM6
  Console Redirection      [Disabled]
  > Console Redirection Settings

COM7 (BMC) (Disabled)
  Console Redirection      Port IS Disabled

iAMT SOL

COM8(Pci Bus0,Dev22,Func3)
  Console Redirection      [Disabled]
  > Console Redirection Settings

-----
-><: Select Screen
↑↓: Select Item
Enter: Select
+/-: Change Opt.
F1: General Help
F2: Previous Values
F3: Optimized Defaults
F4: Save & Exit
ESC: Exit

Version 2.15.1236. Copyright (C) 2012 American Megatrends, Inc.
  
```

#### BIOS Menu 16: Serial Port Console Redirection

##### → Console Redirection [Disabled]

Use **Console Redirection** option to enable or disable the console redirection function.

- **Disabled**      **DEFAULT**      Disabled the console redirection function
- **Enabled**                      Enabled the console redirection function

The following options are available in the **Console Redirection Settings** submenu when the **Console Redirection** option is enabled.

→ **Terminal Type [ANSI]**

Use the **Terminal Type** option to specify the remote terminal type.

- **VT100**                      The target terminal type is VT100
- **VT100+**                      The target terminal type is VT100+
- **VT-UTF8**                      The target terminal type is VT-UTF8
- **ANSI**              **DEFAULT**      The target terminal type is ANSI

→ **Bits per second [115200]**

Use the **Bits per second** option to specify the serial port transmission speed. The speed must match the other side. Long or noisy lines may require lower speeds.

- **9600**                      Sets the serial port transmission speed at 9600.
- **19200**                      Sets the serial port transmission speed at 19200.
- **57600**                      Sets the serial port transmission speed at 57600.
- **115200**              **DEFAULT**      Sets the serial port transmission speed at 115200.

→ **Data Bits [8]**

Use the **Data Bits** option to specify the number of data bits.

- **7**                      Sets the data bits at 7.
- **8**                      **DEFAULT**      Sets the data bits at 8.

## IMBA-C2260-i2 ATX Motherboard

### → Parity [None]

Use the **Parity** option to specify the parity bit that can be sent with the data bits for detecting the transmission errors.

- |   |              |                |   |
|---|--------------|----------------|---|
| → | <b>None</b>  | <b>DEFAULT</b> | No parity bit is sent with the data bits.                                 |
| → | <b>Even</b>  |                | The parity bit is 0 if the number of ones in the data bits is even.       |
| → | <b>Odd</b>   |                | The parity bit is 0 if the number of ones in the data bits is odd.        |
| → | <b>Mark</b>  |                | The parity bit is always 1. This option does not provide error detection. |
| → | <b>Space</b> |                | The parity bit is always 0. This option does not provide error detection. |

### → Stop Bits [1]

Use the **Stop Bits** option to specify the number of stop bits used to indicate the end of a serial data packet. Communication with slow devices may require more than 1 stop bit.

- |   |          |                |                                    |
|---|----------|----------------|------------------------------------|
| → | <b>1</b> | <b>DEFAULT</b> | Sets the number of stop bits at 1. |
| → | <b>2</b> |                | Sets the number of stop bits at 2. |

**5.3.12 iEi Feature**

Use the **iEi Feature** menu (**BIOS Menu 17**) to configure One Key Recovery function.

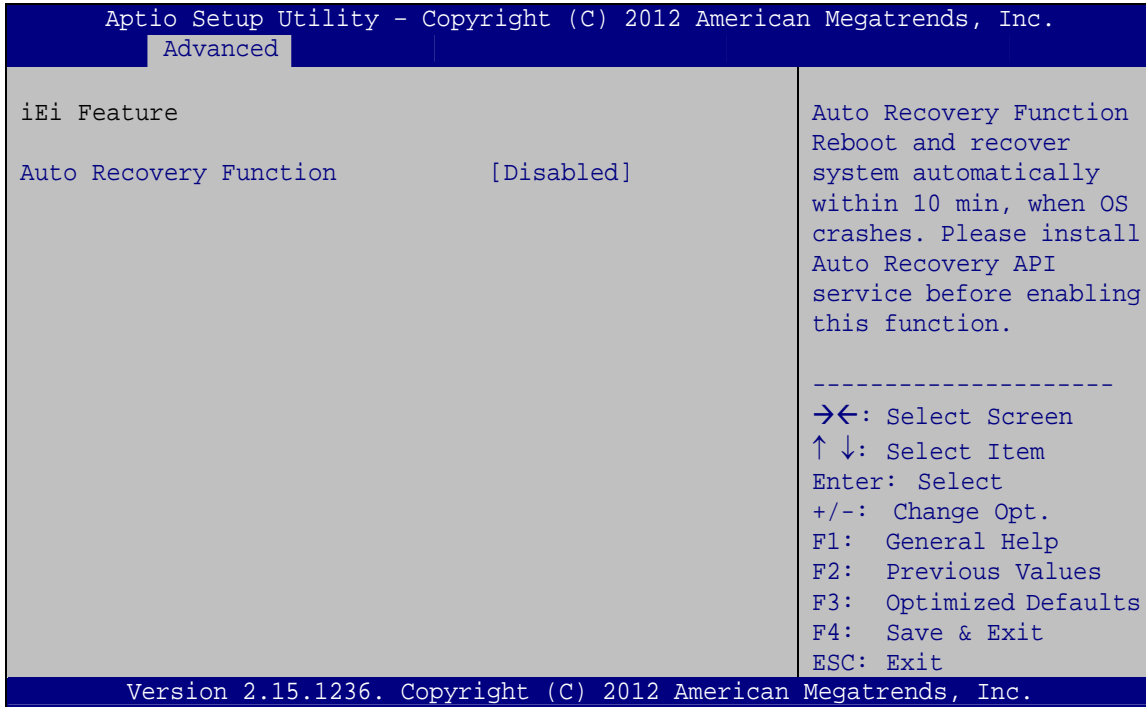

**BIOS Menu 17: iEi Feature**

➔ **Auto Recovery Function [Disabled]**

Use the **Auto Recovery Function** BIOS option to enable or disable the auto recovery function of the IEI One Key Recovery.

- ➔ **Disabled**      **DEFAULT**      Auto recovery function disabled
- ➔ **Enabled**        Auto recovery function enabled

## IMBA-C2260-i2 ATX Motherboard

## 5.4 Chipset

Use the **Chipset** menu (**BIOS Menu 18**) to access the PCH IO and System Agent (SA) configuration menus.

**WARNING!**

Setting the wrong values for the Chipset BIOS selections in the Chipset BIOS menu may cause the system to malfunction.

```
Aptio Setup Utility - Copyright (C) 2012 American Megatrends, Inc.
Main   Advanced  Chipset  Boot   Security  Save & Exit  Server Mgmt
-----
> PCH-IO Configuration
> System Agent (SA) Configuration

PCH Parameters
-----
-><: Select Screen
↑ ↓: Select Item
Enter: Select
+/-: Change Opt.
F1: General Help
F2: Previous Values
F3: Optimized Defaults
F4: Save & Exit
ESC: Exit

Version 2.15.1236. Copyright (C) 2012 American Megatrends, Inc.
```

**BIOS Menu 18: Chipset**



### 5.4.1 PCH-IO Configuration

Use the **PCH-IO Configuration** menu (**BIOS Menu 19**) to configure the PCH parameters.

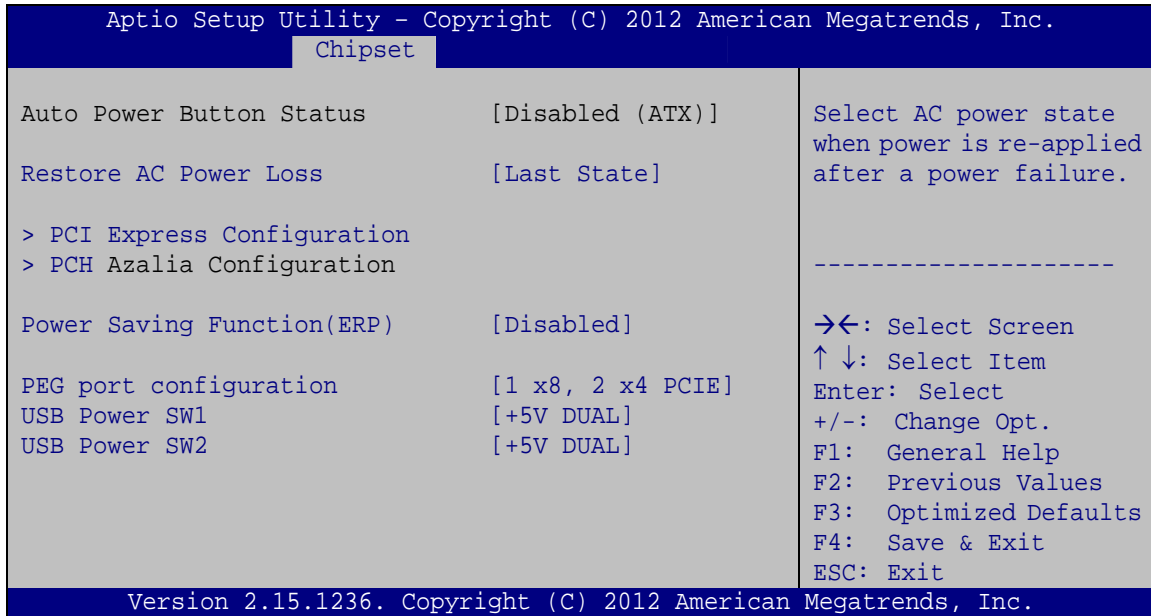

#### BIOS Menu 19: PCH-IO Configuration

##### → Restore AC Power Loss [Last State]

Use the **Restore AC Power Loss** BIOS option to specify what state the system returns to if there is a sudden loss of power to the system.

- **Power Off**                      The system remains turned off
- **Power On**                        The system turns on
- **Last State**    **DEFAULT**      The system returns to its previous state. If it was on, it turns itself on. If it was off, it remains off.

##### → Power Saving Function(ERP) [Disabled]

Use the **Power Saving Function(ERP)** BIOS option to enable or disable the power saving function.

- **Disabled**            **DEFAULT**      Power saving function is disabled.
- **Enabled**                Power saving function is enabled. It will reduce power consumption when the system is off.

## IMBA-C2260-i2 ATX Motherboard

### → PEG port configuration [1 x8, 2 x4 PCIE]

Use the **PEG port configuration** BIOS option to configure the channel mode for the PCIe x16 slot. When setting to **1 x16 PCIE** option, the PCIEX4\_2 and PCIEX4\_3 slots will be disabled.

- **1 x16 PCIE** Sets the PCIe x16 slot as one PCIe x16
- **1 x8, 2 x4 PCIE** **DEFAULT** Sets the PCIe x16 slot as one PCIe x8 or two PCIe x4

### → USB Power SW1 [+5V DUAL]

Use the **USB Power SW1** BIOS option to configure the USB power source for the corresponding USB connectors (**Table 5-2**).

- **+5V** Sets the USB power source to +5V
- **+5V DUAL** **DEFAULT** Sets the USB power source to +5V dual

### → USB Power SW2 [+5V DUAL]

Use the **USB Power SW2** BIOS option to configure the USB power source for the corresponding USB connectors (**Table 5-2**).

- **+5V** Sets the USB power source to +5V
- **+5V DUAL** **DEFAULT** Sets the USB power source to +5V dual

| BIOS Options  | Configured USB Ports   |
|---------------|--|
| USB Power SW1 | K/M_USB1 (external USB 2.0 ports)<br>LAN1_USB1 (external USB 3.0 ports)                              |
| USB Power SW2 | USB1 (internal USB 2.0 ports)<br>USB2 (internal USB 2.0 ports)<br>LAN1_USB2 (external USB 3.0 ports) |

**Table 5-2: BIOS Options and Configured USB Ports**

### 5.4.1.1 PCI Express Configuration

Use the **PCI Express Configuration** menu (**BIOS Menu 20**) to configure the PCI Express slots.

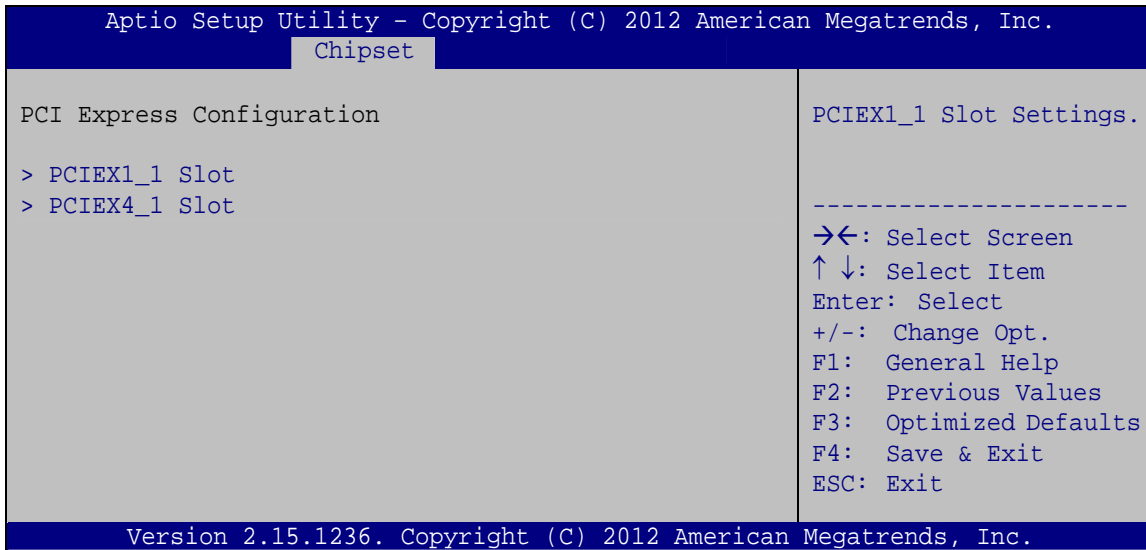

**BIOS Menu 20: PCI Express Configuration**

#### 5.4.1.1.1 PCIEX1\_1 Slot and PCIEX4\_1 Slot

Use the **PCIEX1\_1 Slot** and **PCIEX4\_1 Slot** menus (**BIOS Menu 21**) to configure the **PCIEX1\_1** and **PCIEX4\_1** slot settings.

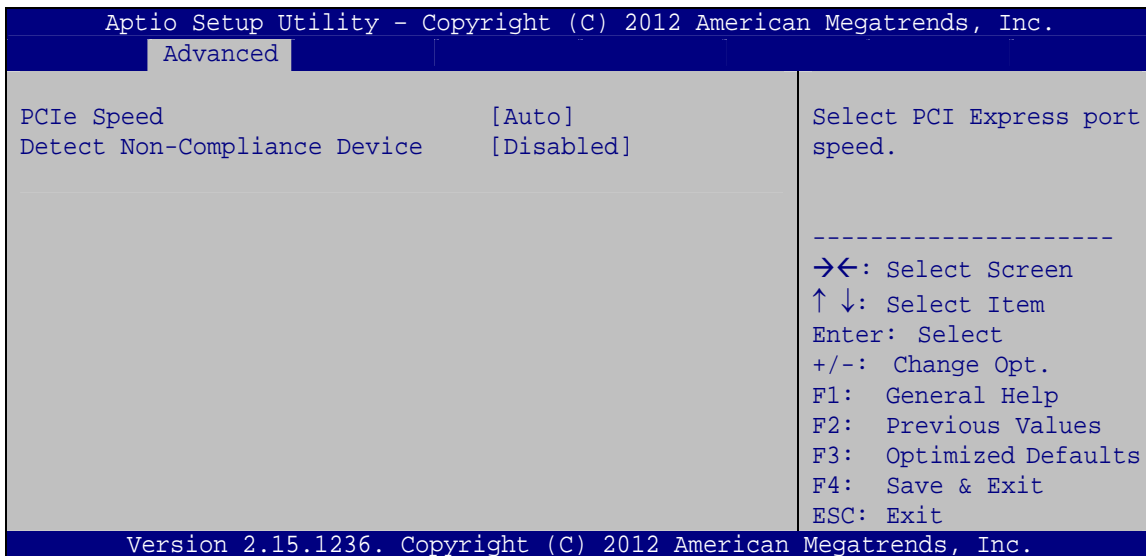

**BIOS Menu 21: PCIEX1\_1 Slot and PCIEX4\_1 Slot Configuration Menu**

## IMBA-C2260-i2 ATX Motherboard

### → PCIe Speed [Gen1]

Use this option to select the support type of the PCI Express slots. The following options are available:

- Auto                    **Default**
- Gen1
- Gen2

### → Detect Non-Compliance Device [Disabled]

Use the **Detect Non-Compliance Device** option to enable or disable detecting if a non-compliance PCI Express device is connected to the PCI Express slot.

- **Disabled**                    **DEFAULT**      Disables to detect if a non-compliance PCI Express device is connected to the PCI Express slot.
  
- **Enabled**                      Enables to detect if a non-compliance PCI Express device is connected to the PCI Express slot.

### 5.4.1.2 PCH Azalia Configuration

Use the **PCH Azalia Configuration** menu (**BIOS Menu 20**) to configure the PCH Azalia settings.

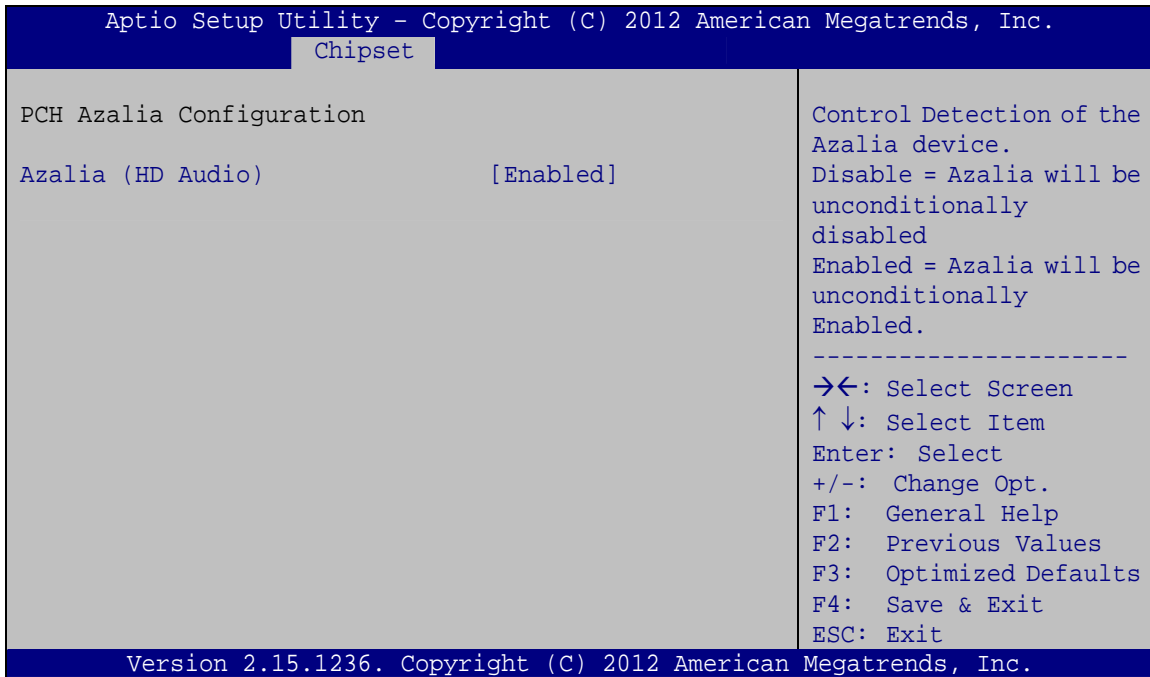

#### BIOS Menu 22: PCH Azalia Configuration

##### → Azalia (HD Audio) [Enabled]

Use the **Azalia (HD Audio)** option to enable or disable the High Definition Audio controller.

- **Disabled**                      The onboard High Definition Audio controller is disabled
- **Enabled**    **DEFAULT**      The onboard High Definition Audio controller automatically detected and enabled

## IMBA-C2260-i2 ATX Motherboard

### 5.4.2 System Agent (SA) Configuration

Use the **System Agent (SA) Configuration** menu (**BIOS Menu 23**) to configure the System Agent (SA) parameters.

```

Aptio Setup Utility - Copyright (C) 2012 American Megatrends, Inc.
Chipset
-----
> Graphics Configuration
> NB PCIe Configuration
> Memory Configuration

Config Graphics
Settings.

-----
-><: Select Screen
↑ ↓: Select Item
Enter: Select
+/-: Change Opt.
F1: General Help
F2: Previous Values
F3: Optimized Defaults
F4: Save & Exit
ESC: Exit

Version 2.15.1236. Copyright (C) 2012 American Megatrends, Inc.
    
```

**BIOS Menu 23: System Agent (SA) Configuration**

#### 5.4.2.1 Graphics Configuration

Use the **Graphics Configuration** (**BIOS Menu 24**) menu to configure the video device connected to the system.

```

Aptio Setup Utility - Copyright (C) 2012 American Megatrends, Inc.
Chipset
-----
Graphics Configuration

Primary Display           [Auto]
DVTM Pre-Allocated       [256M]
DVTM Total Gfx Mem       [MAX]
> LCD Control

Select which of
IGFX/PEG/PCI Graphics
device should be Primary
Display Or select SG for
Switchable Gfx.

-----
-><: Select Screen
↑ ↓: Select Item
Enter: Select
+/-: Change Opt.
F1: General Help
F2: Previous Values
F3: Optimized Defaults
F4: Save & Exit
ESC: Exit

Version 2.15.1236. Copyright (C) 2012 American Megatrends, Inc.
    
```

**BIOS Menu 24: Graphics Configuration**

**→ Primary Display [Auto]**

Use the **Primary Display** option to select the primary graphics controller the system uses.

The following options are available:

- Auto                   **Default**
- IGFX
- PEG
- PCIE/PCI

**→ DVMT Pre-Allocated [256M]**

Use the **DVMT Pre-Allocated** option to set the amount of system memory allocated to the integrated graphics processor when the system boots. The system memory allocated can then only be used as graphics memory, and is no longer available to applications or the operating system. Configuration options are listed below:

- 32M
- 64M
- 128M
- 256M                   **Default**
- 512M

**→ DVMT Total Gfx Mem [MAX]**

Use the **DVMT Total Gfx Mem** option to select DVMT5.0 total graphic memory size used by the internal graphic device. The following options are available:

- 128M
- 256M
- MAX                   **Default**

## IMBA-C2260-i2 ATX Motherboard

### 5.4.2.1.1 LCD Control

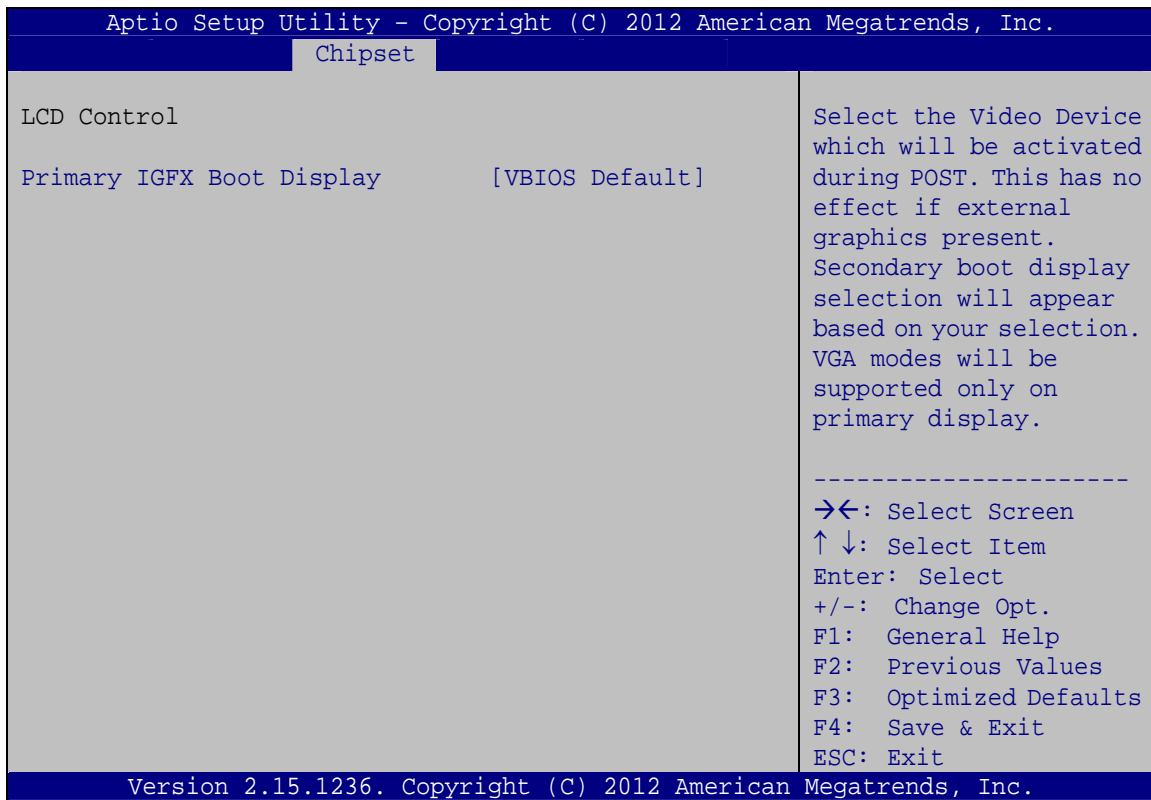

#### BIOS Menu 25: LCD Control

#### → Primary IGFX Boot Display [VBIOS Default]

Use the **Primary IGFX Boot Display** option to select the display device used by the system when it boots. Configuration options are listed below.

- VBIOS Default      **DEFAULT**
- CRT
- DP



### 5.4.2.2 NB PCIe Configuration

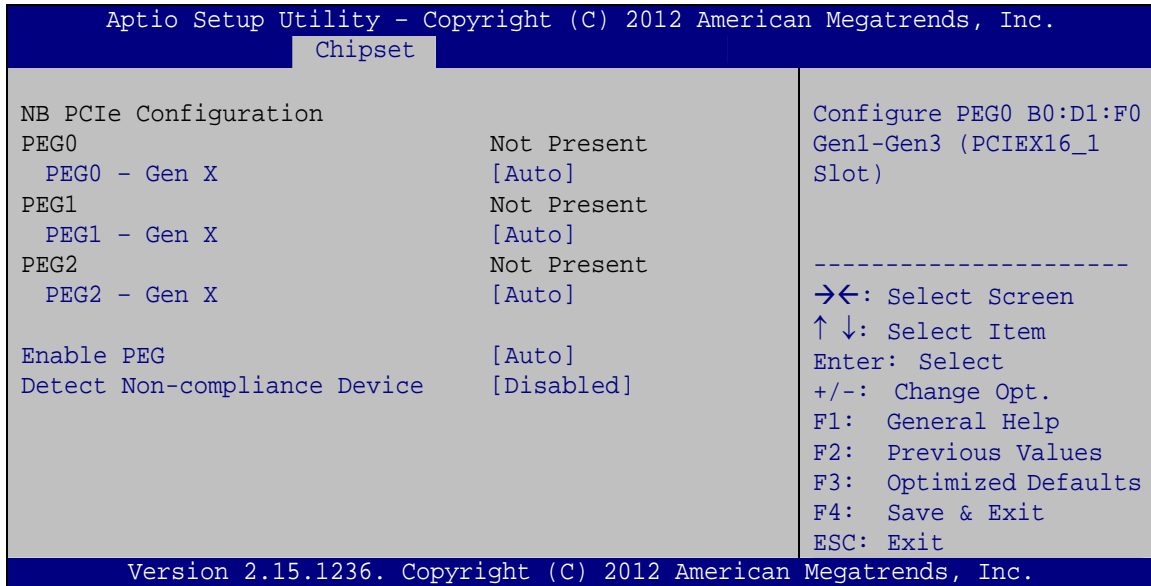

#### BIOS Menu 26: NB PCIe Configuration

##### → PEG0 – Gen X [Auto]

Use the **PEG0 – Gen X** option to select the support type of the PCI Express x16 slot (PCIEX16\_1). The following options are available:

- Auto                      **Default**
- Gen1
- Gen2
- Gen3

##### → PEG1 – Gen X [Auto]

Use the **PEG1 – Gen X** option to select the support type of the PCI Express x4 slot (PCIEX4\_2). The following options are available:

- Auto                      **Default**
- Gen1
- Gen2
- Gen3

## IMBA-C2260-i2 ATX Motherboard

### → PEG2 – Gen X [Auto]

Use the **PEG2– Gen X** option to select the support type of the PCI Express x4 slot (PCIEX4\_3). The following options are available:

- Auto                   **Default**
- Gen1
- Gen2
- Gen3

### → Enable PEG [Auto]

Use the **Enable PEG** option to enable or disable the PCI Express (PEG) controller.

- **Disabled**                                   Disables the PCI Express (PEG) controller.
- **Enabled**                                   Enables the PCI Express (PEG) controller.
- **Auto**                                   **DEFAULT**   The PCI Express (PEG) controller is disabled if no PCI Express devices are connected.

### → Detect Non-Compliance Device [Enabled]

Use the **Detect Non-Compliance Device** option to enable or disable detecting if a non-compliance PCI Express device is connected to the PCI Express port.

- **Disabled**                                   Disables to detect if a non-compliance PCI Express device is connected to the PCI Express port.
- **Enabled**                                   **DEFAULT**   Enables to detect if a non-compliance PCI Express device is connected to the PCI Express port.

### 5.4.2.3 Memory Configuration

Use the **Memory Configuration** submenu (**BIOS Menu 27**) to view memory information.

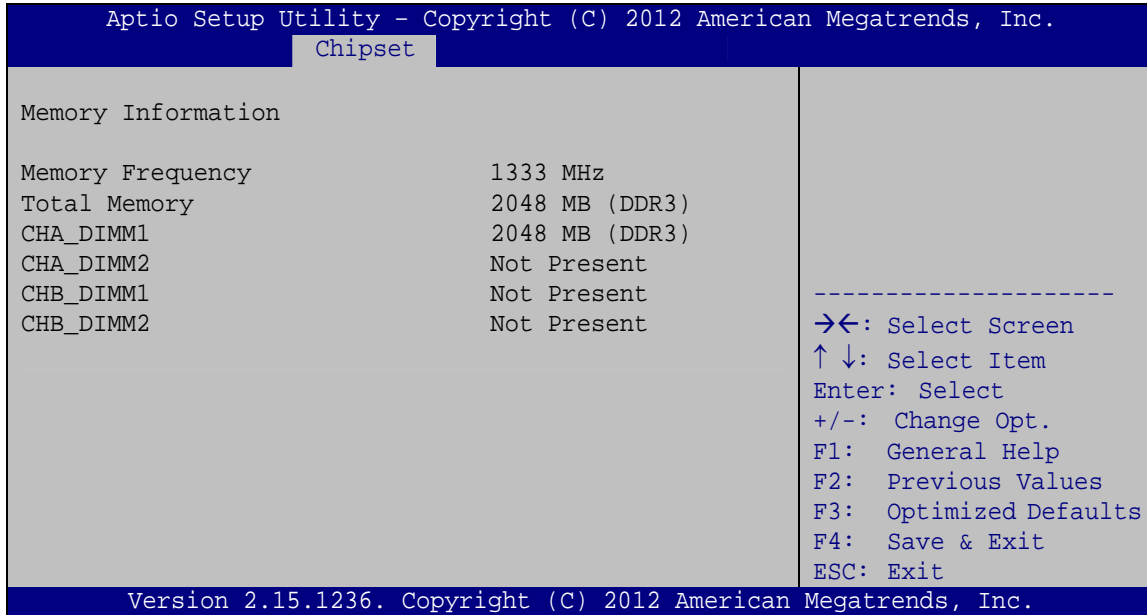

**BIOS Menu 27: Memory Configuration**

## 5.5 Boot

Use the **Boot** menu (**BIOS Menu 28**) to configure system boot options.

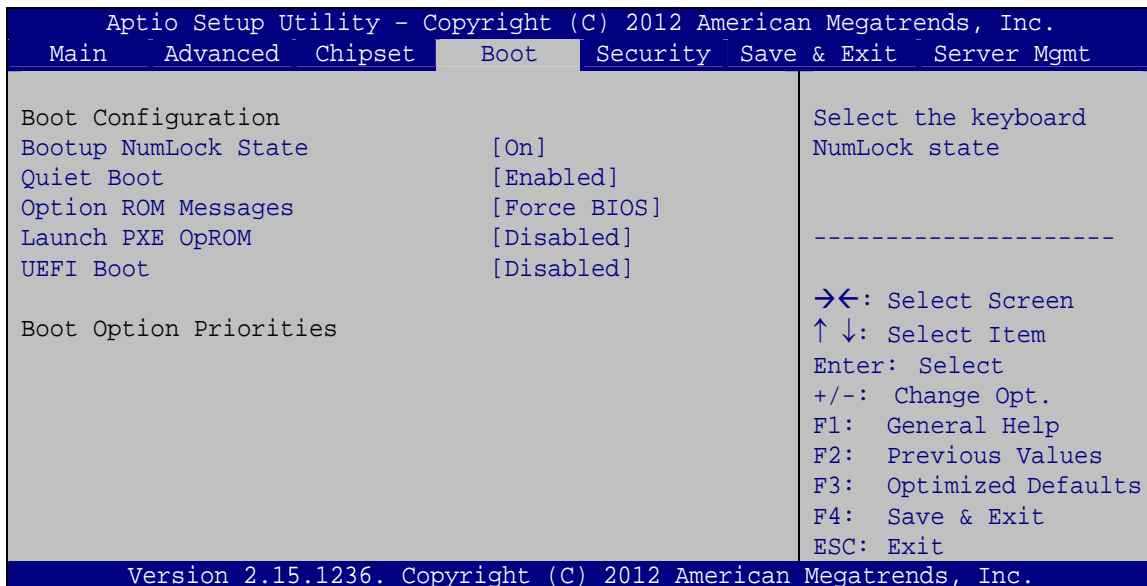

**BIOS Menu 28: Boot**

## IMBA-C2260-i2 ATX Motherboard

### → **Bootup NumLock State [On]**

Use the **Bootup NumLock State** BIOS option to specify if the number lock setting must be modified during boot up.

- **On**                      **DEFAULT**                      Allows the Number Lock on the keyboard to be enabled automatically when the computer system boots up. This allows the immediate use of the 10-key numeric keypad located on the right side of the keyboard. To confirm this, the Number Lock LED light on the keyboard is lit.
  
- **Off**                                      Does not enable the keyboard Number Lock automatically. To use the 10-keys on the keyboard, press the Number Lock key located on the upper left-hand corner of the 10-key pad. The Number Lock LED on the keyboard lights up when the Number Lock is engaged.

### → **Quiet Boot [Enabled]**

Use the **Quiet Boot** BIOS option to select the screen display when the system boots.

- **Disabled**                                      Normal POST messages displayed
  
- **Enabled**                      **DEFAULT**                      OEM Logo displayed instead of POST messages

### → **Option ROM Messages [Force BIOS]**

Use the **Option ROM Messages** option to set the Option ROM display mode.

- **Force BIOS**                      **DEFAULT**                      Sets display mode to force BIOS.
  
- **Keep Current**                                      Sets display mode to current.

### → Launch PXE OpROM [Disabled]

Use the **Launch PXE OpROM** option to enable or disable boot option for legacy network devices.

- **Disabled**     **DEFAULT**     Ignore all PXE Option ROMs
- **Enabled**                     Load PXE Option ROMs.

### → UEFI Boot [Disabled]

Use the **UEFI Boot** option to enable or disable to boot from the UEFI devices.

- **Enabled**                     Boot from UEFI devices is enabled.
- **Disabled**     **DEFAULT**     Boot from UEFI devices is disabled.

## 5.6 Security

Use the **Security** menu (**BIOS Menu 29**) to set system and user passwords.

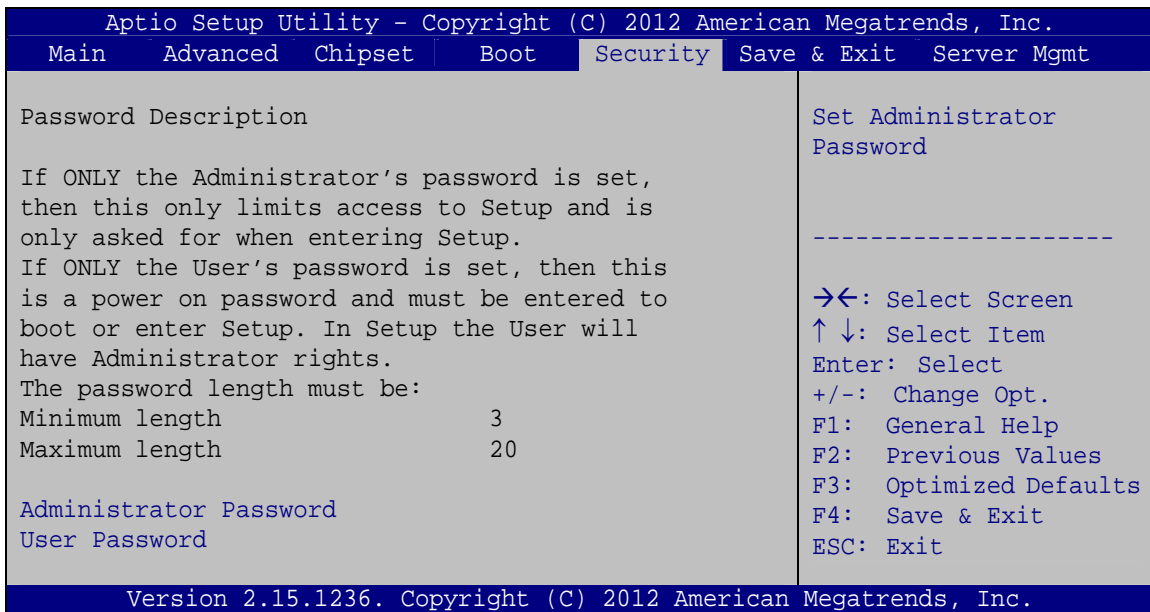

### BIOS Menu 29: Security

#### → Administrator Password

Use the **Administrator Password** to set or change a administrator password.

## IMBA-C2260-i2 ATX Motherboard

### → User Password

Use the **User Password** to set or change a user password.

## 5.7 Save & Exit

Use the **Safe & Exit** menu (**BIOS Menu 30**) to load default BIOS values, optimal failsafe values and to save configuration changes.

```

Aptio Setup Utility - Copyright (C) 2012 American Megatrends, Inc.
Main   Advanced  Chipset  Boot   Security  Save & Exit  Server Mgmt
-----
Save Changes and Reset
Discard Changes and Reset

Restore Defaults
Save as User Defaults
Restore User Defaults

Exit the system after
saving the changes.

-----
→←: Select Screen
↑↓: Select Item
Enter: Select
+/-: Change Opt.
F1: General Help
F2: Previous Values
F3: Optimized Defaults
F4: Save & Exit
ESC: Exit

Version 2.15.1236. Copyright (C) 2012 American Megatrends, Inc.

```

### BIOS Menu 30: Save & Exit

#### → Save Changes and Reset

Use the **Save Changes and Reset** option to save the changes made to the BIOS options and reset the system.

#### → Discard Changes and Reset

Use the **Discard Changes and Reset** option to exit the system without saving the changes made to the BIOS configuration setup program.

#### → Restore Defaults

Use the **Restore Defaults** option to load the optimal default values for each of the parameters on the Setup menus. **F3 key can be used for this operation.**

→ **Save as User Defaults**

Use the **Save as User Defaults** option to save the changes done so far as user defaults.

→ **Restore User Defaults**

Use the **Restore User Defaults** option to restore the user defaults to all the setup options.

### 5.8 Server Mgmt

Use the **Server Mgmt** menu (**BIOS Menu 31**) to configure system event log and BMC network parameters.

```

Aptio Setup Utility - Copyright (C) 2012 American Megatrends, Inc.
Main   Advanced  Chipset  Boot   Security  Save & Exit  Server Mgmt
-----
BMC Self Test Status
> System Event Log
> BMC network configuration

Press <Enter> to change
the SEL event log
configuration.

-----
-><: Select Screen
↑↓: Select Item
Enter: Select
+/-: Change Opt.
F1:  General Help
F2:  Previous Values
F3:  Optimized Defaults
F4:  Save & Exit
ESC: Exit

Version 2.15.1236. Copyright (C) 2012 American Megatrends, Inc.
    
```

**BIOS Menu 31: Server Mgmt**

## IMBA-C2260-i2 ATX Motherboard

### 5.8.1 System Event Log

Use the **System Event Log** menu (**BIOS Menu 32**) to configure system event log options.

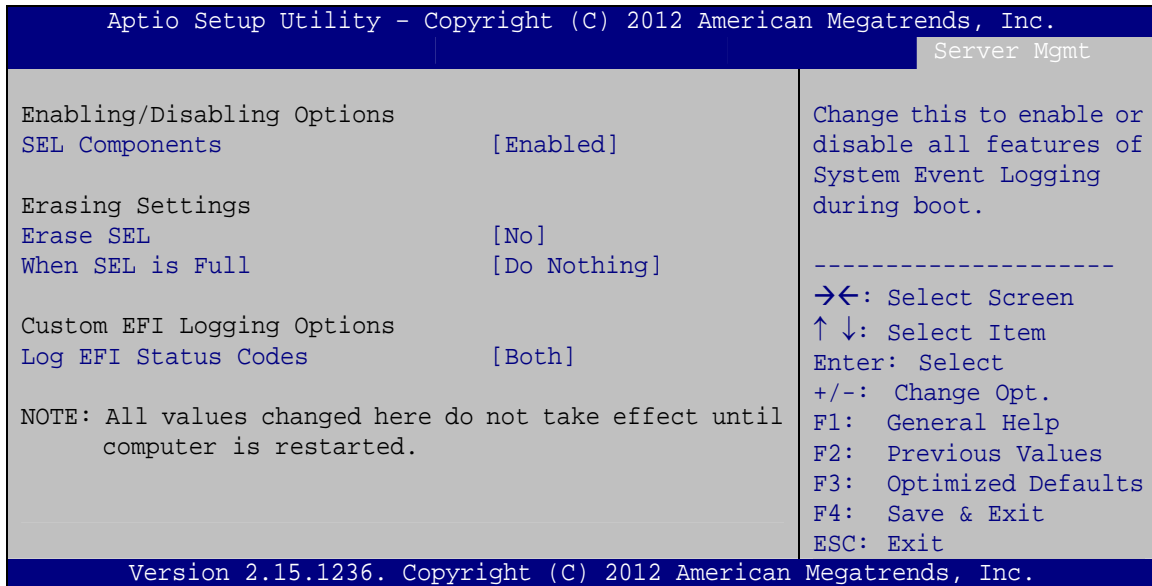

#### BIOS Menu 32: System Event Log

##### → SEL Components [Enabled]

Use the **SEL Components** option to enable or disable all features of System Event Log during boot.

- **Disabled** System Event Log features disabled.
- **Enabled** **DEFAULT** System Event Log features enabled.

##### → Erase SEL [No]

Use the **Erase SEL** option to select an option for erasing SEL (system event log).

- **No** **DEFAULT** Do not erase SEL
- **Yes,**  
**On next reset** Erase SEL on next reset
- **Yes,**  
**On every reset** Erase SEL on every reset





## IMBA-C2260-i2 ATX Motherboard

### 5.8.2 BMC Network Configuration

Use the **BMC Network Configuration** menu (**BIOS Menu 33**) to configure BMC network parameters.

```

Aptio Setup Utility - Copyright (C) 2012 American Megatrends, Inc.
Server Mgmt
-----
BMC network configuration
Lan channel 1
Configuration Address source      [Unspecified]
Station IP address                -
Subnet mask                       -
Station MAC address               -
Router IP address                 -
Router MAC address                -

Select to configure LAN
channel parameters
statically or
dynamically (by BIOS or
BMC). Unspecified option
will not modify any BMC
network parameters
during BIOS phase

-----
-><: Select Screen
↑↓: Select Item
Enter: Select
+/-: Change Opt.
F1: General Help
F2: Previous Values
F3: Optimized Defaults
F4: Save & Exit
ESC: Exit

Version 2.15.1236. Copyright (C) 2012 American Megatrends, Inc.
  
```

#### BIOS Menu 33: System Event Log

##### → Configuration Address source [Unspecified]

Use the **Configuration Address source** to configure LAN channel parameters statically or dynamically (by BIOS or BMC).

- **Unspecified**                      **DEFAULT**      BMC network parameters will not be modified during BIOS phase.
  
- **Static**                              Select to modify the following BMC network parameters:
  - Station IP address
  - Subnet mask
  - Station MAC address
  - Router IP address
  - Router MAC address

## IMBA-C2260-i2 ATX Motherboard

- **Dynamic-Obtained by BMC**  
Select to configure LAN channel parameters dynamically by BMC
- **Dynamic-Loaded by BIOS**  
Select to configure LAN channel parameters dynamically by BIOS
- **Dynamic-BMC running Other Protocol**  
Select to configure LAN channel parameters dynamically by BMC running other protocol

Chapter

**6**

# Software Drivers

---

## 6.1 Available Software Drivers

---



### NOTE:

The content of the CD may vary throughout the life cycle of the product and is subject to change without prior notice. Visit the IEI website or contact technical support for the latest updates.

---

The following drivers can be installed on the system:

- Chipset
- VGA
- LAN
- USB 3.0
- Audio
- Intel® AMT

Installation instructions are given below.

## 6.2 Software Installation

All the drivers for the IMBA-C2260-i2 are on the CD that came with the system. To install the drivers, please follow the steps below.

**Step 1:** Insert the CD into a CD drive connected to the system.

---



### NOTE:

If the installation program doesn't start automatically:  
Click "Start->My Computer->CD Drive->autorun.exe"

---

**Step 2:** The driver main menu appears (**Figure 6-1**).

**IMBA-C2260-i2 ATX Motherboard**



**Figure 6-1: Introduction Screen**

**Step 3:** Click IMBA-C2260-i2.

**Step 4:** A new screen with a list of available drivers appears (**Figure 6-2**).



**Figure 6-2: Available Drivers**

**Step 5:** Install all of the necessary drivers in this menu.

## 6.3 Chipset Driver Installation

To install the chipset driver, please do the following.

**Step 1:** Access the driver list. (See **Section 6.2**)

**Step 2:** Click “1-Chipset”.

**Step 3:** Locate the setup file and double click on it.

**Step 4:** When the setup files are completely extracted, the **Welcome Screen** in **Figure 6-3** appears.

**Step 5:** Click **Next** to continue.



**Figure 6-3: Chipset Driver Welcome Screen**

**Step 6:** The license agreement in **Figure 6-4** appears.

**Step 7:** Read the **License Agreement**.

**Step 8:** Click **Yes** to continue.

IMBA-C2260-i2 ATX Motherboard



Figure 6-4: Chipset Driver License Agreement

**Step 9:** The Read Me file in Figure 6-5 appears.

**Step 10:** Click **Next** to continue.

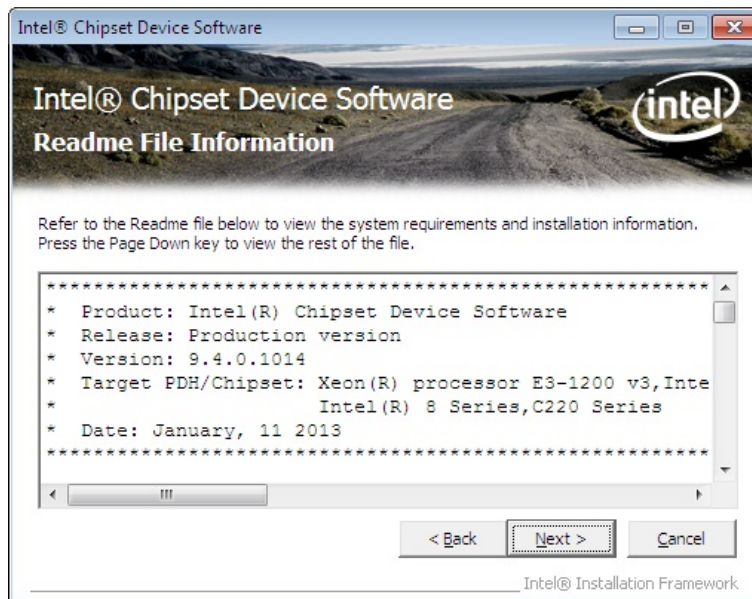
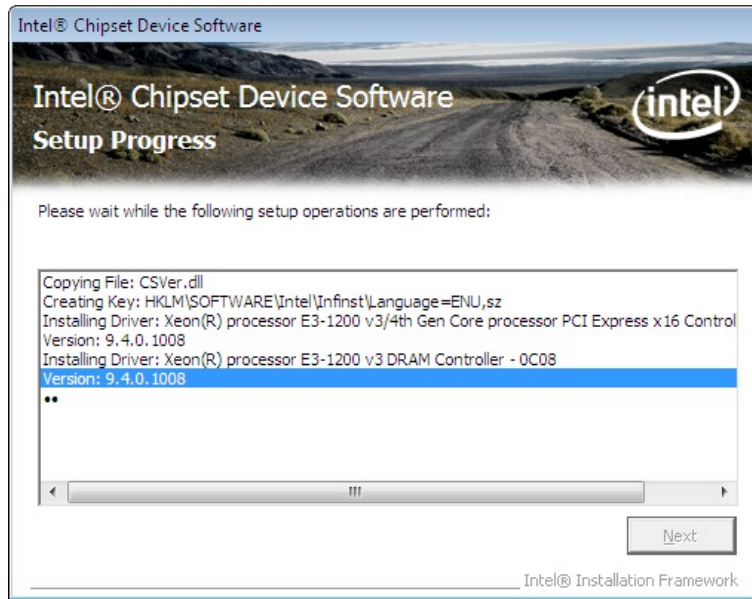

Figure 6-5: Chipset Driver Read Me File

**Step 11:** Setup Operations are performed as shown in Figure 6-6.

**Step 12:** Once the Setup Operations are complete, click **Next** to continue.





**Figure 6-6: Chipset Driver Setup Operations**

**Step 13:** The **Finish** screen in **Figure 6-7** appears.

**Step 14:** Select **“Yes, I want to restart this computer now”** and click **Finish**.



**Figure 6-7: Chipset Driver Installation Finish Screen**

## IMBA-C2260-i2 ATX Motherboard

### 6.4 Graphics Driver Installation

To install the Graphics driver, please do the following.

- Step 1:** Access the driver list. (See **Section 6.2**)
- Step 2:** Click “**2-Graphic**” and select the folder which corresponds to the operating system.
- Step 3:** Locate the setup file and double click on it.
- Step 4:** The **Welcome Screen** in **Figure 6-8** appears.
- Step 5:** Click **Next** to continue.



**Figure 6-8: Graphics Driver Welcome Screen**

- Step 6:** The **License Agreement** in **Figure 6-9** appears.
- Step 7:** Click **Yes** to accept the agreement and continue.



**Figure 6-9: Graphics Driver License Agreement**

**Step 8:** The **Read Me** file in **Figure 6-10** appears. Click **Next** to continue.

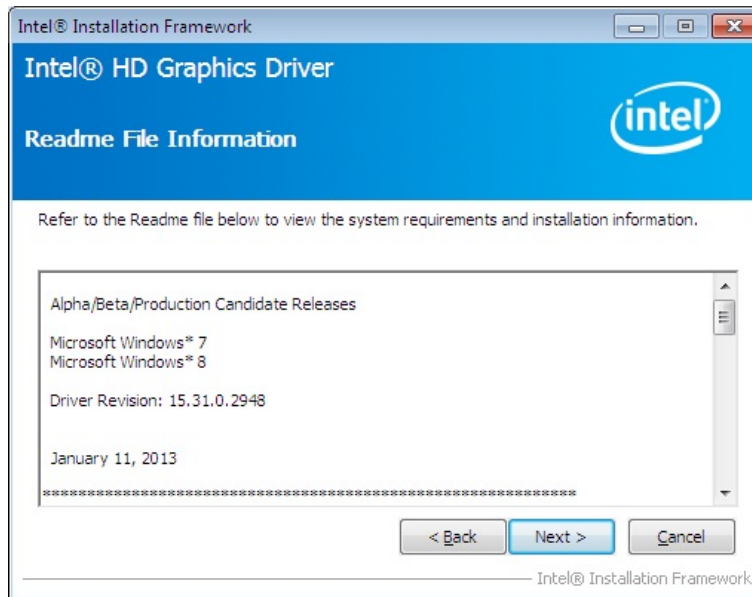

**Figure 6-10: Graphics Driver Read Me File**

**Step 9:** **Setup Operations** are performed as shown in **Figure 6-11**.

**Step 10:** Once the **Setup Operations** are complete, click **Next** to continue.

## IMBA-C2260-i2 ATX Motherboard

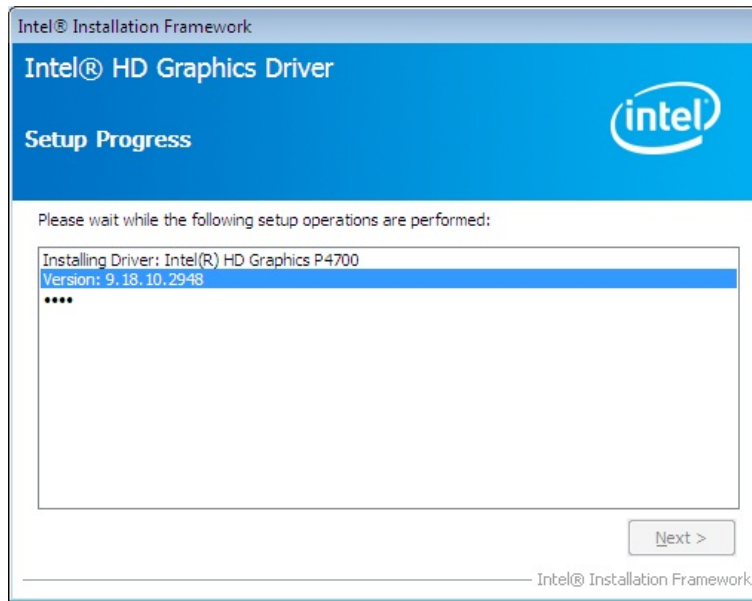

Figure 6-11: Graphics Driver Setup Operations

**Step 11:** The **Finish** screen in Figure 6-12 appears.

**Step 12:** Select “**Yes, I want to restart this computer now**” and click **Finish**.

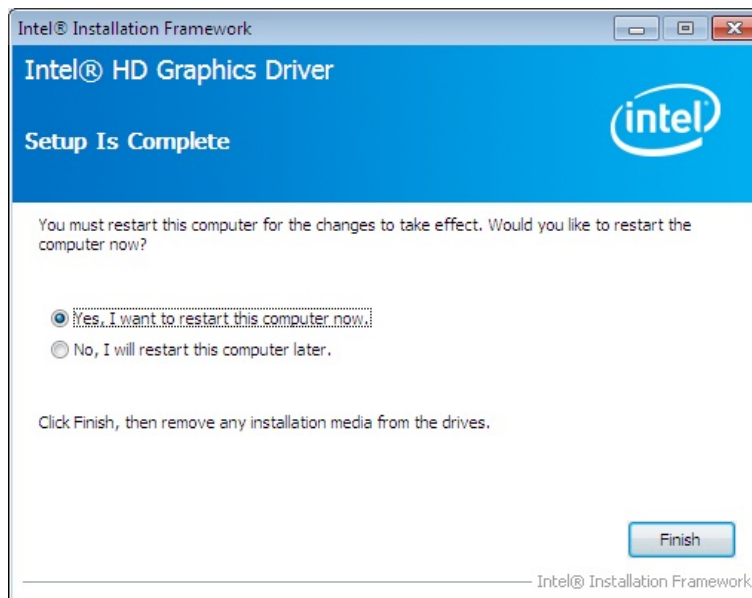

Figure 6-12: Graphics Driver Installation Finish Screen

## 6.5 LAN Driver Installation

To install the LAN driver, please do the following.

**Step 1:** Access the driver list. (See **Section 6.2**)

**Step 2:** Click “3-LAN”.

**Step 3:** Select the folder with the driver of correspondent LAN controller.

**Step 4:** Locate the Autorun file and double click on it.

**Step 5:** The Intel® Network Connection menu in **Figure 6-13** appears.

**Step 6:** Click **Install Drivers and Software**.

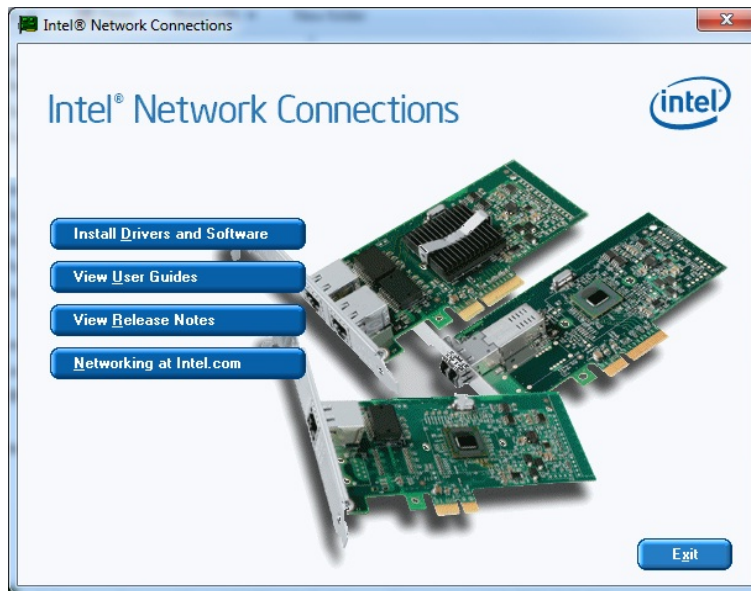

**Figure 6-13: Intel® Network Connection Menu**

**Step 7:** The **Welcome** screen in **Figure 6-14** appears.

## IMBA-C2260-i2 ATX Motherboard



Figure 6-14: LAN Driver Welcome Screen

**Step 8:** Click **Next** to continue.

**Step 9:** The **License Agreement** in Figure 6-15 appears.

**Step 10:** Accept the agreement by selecting "I accept the terms in the license agreement".

**Step 11:** Click **Next** to continue.

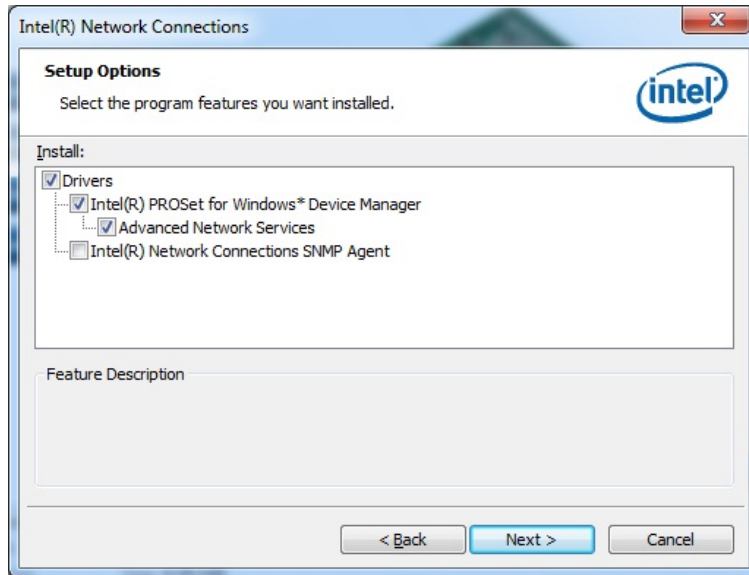

Figure 6-15: LAN Driver License Agreement

**Step 12:** The **Setup Options** screen in **Figure 6-16** appears.

**Step 13:** Select program features to install.

**Step 14:** Click **Next** to continue.

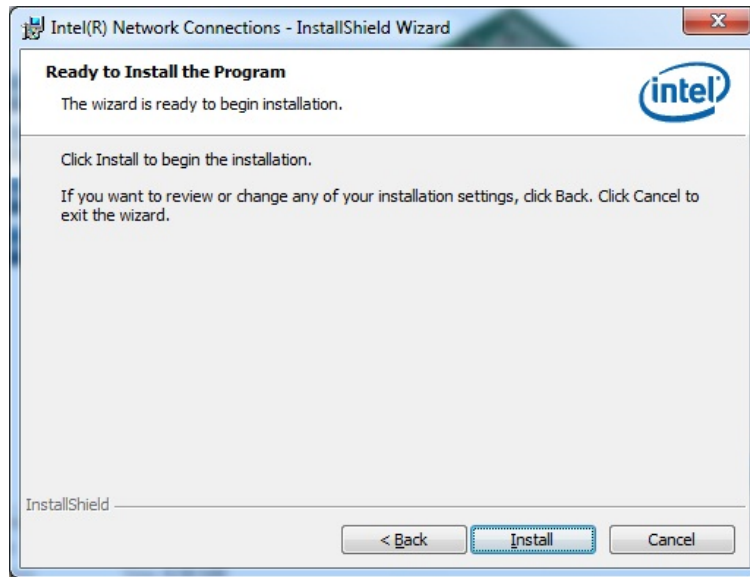

**Figure 6-16: LAN Driver Setup Options**

**Step 15:** The **Ready to Install the Program** screen in **Figure 6-17** appears.

**Step 16:** Click **Install** to proceed with the installation.

## IMBA-C2260-i2 ATX Motherboard

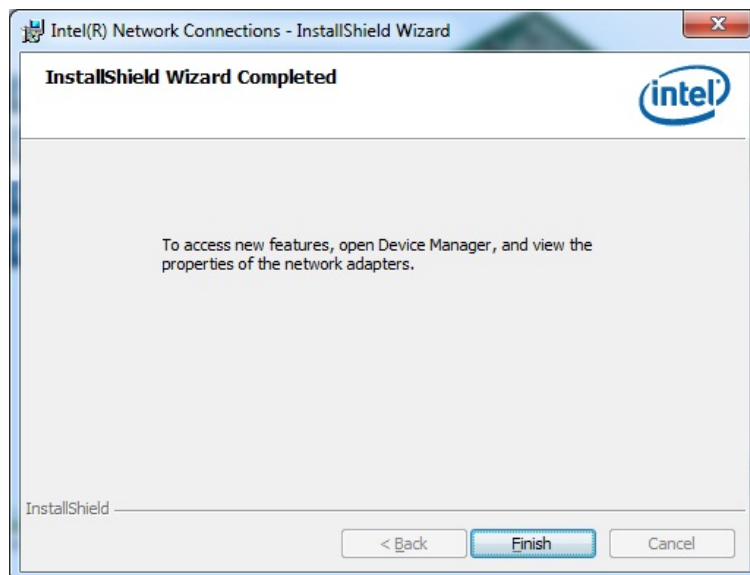

**Figure 6-17: LAN Driver Installation**

**Step 17:** The program begins to install.

**Step 18:** When the driver installation is complete, the screen in **Figure 6-18** appears.

**Step 19:** Click **Finish** to exit.



**Figure 6-18: LAN Driver Installation Complete**



## 6.6 USB 3.0 Driver Installation



### WARNING:

Do not run this driver's installer (Setup.exe) from a USB storage device (ie. external USB hard drive or USB thumb drive). For proper installation, please copy driver files to a local hard drive folder and run from there.

To install the USB 3.0 driver, please follow the steps below.

- Step 1:** Access the driver list. (See **Section 6.2**)
- Step 2:** Click “4-USB3.0”.
- Step 3:** Locate the setup file and double click on it.
- Step 4:** A **Welcome Screen** appears (**Figure 6-19**).
- Step 5:** Click **Next** to continue.



**Figure 6-19: USB 3.0 Driver Welcome Screen**

- Step 6:** The license agreement in **Figure 6-20** appears.

## IMBA-C2260-i2 ATX Motherboard

**Step 7:** Read the **License Agreement**.

**Step 8:** Click **Yes** to continue.



**Figure 6-20: USB 3.0 Driver License Agreement**

**Step 9:** The **Read Me** file in **Figure 6-21** appears.

**Step 10:** Click **Next** to continue.



**Figure 6-21: USB 3.0 Driver Read Me File**

**Step 11:** Setup Operations are performed as shown in Figure 6-22.

**Step 12:** Once the Setup Operations are complete, click **Next** to continue.

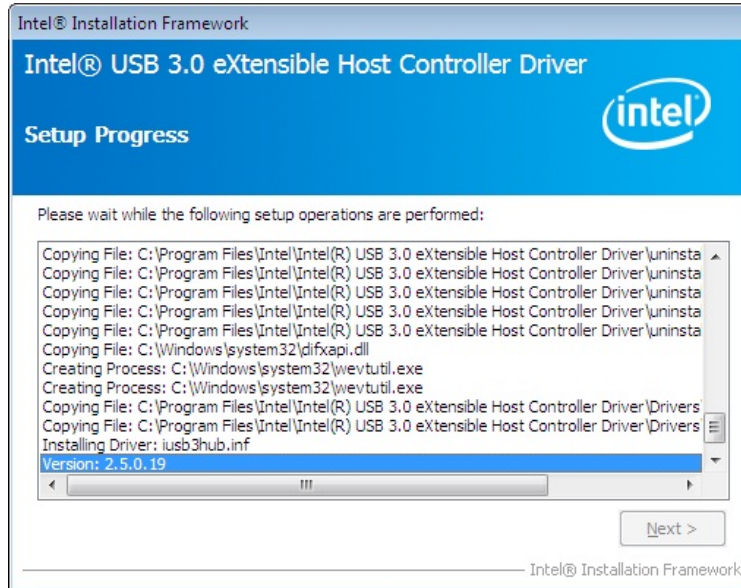

**Figure 6-22: USB 3.0 Driver Setup Operations**

**Step 13:** The **Finish** screen in Figure 6-23 appears.

**Step 14:** Select “**Yes, I want to restart this computer now**” and click **Finish**.

## IMBA-C2260-i2 ATX Motherboard

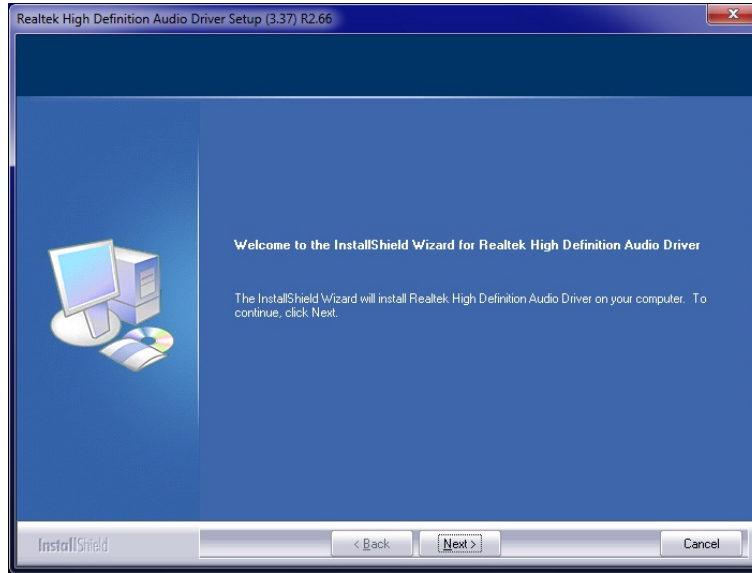

Figure 6-23: USB 3.0 Driver Installation Finish Screen

## 6.7 Audio Driver Installation

To install the audio driver, please do the following.

- Step 1:** Access the driver list. (See **Section 6.2**)
- Step 2:** Click “**5-Audio**” and select the folder which corresponds to the operating system.
- Step 3:** Double click the setup file.
- Step 4:** The **InstallShield Wizard** is prepared to guide the user through the rest of the process.
- Step 5:** Once initialized, the **InstallShield Wizard** welcome screen appears (**Figure 6-24**).



**Figure 6-24: InstallShield Wizard Welcome Screen**

**Step 6:** Click **Next** to continue the installation.

**Step 7:** InstallShield starts to install the new software as shown in **Figure 6-25**.

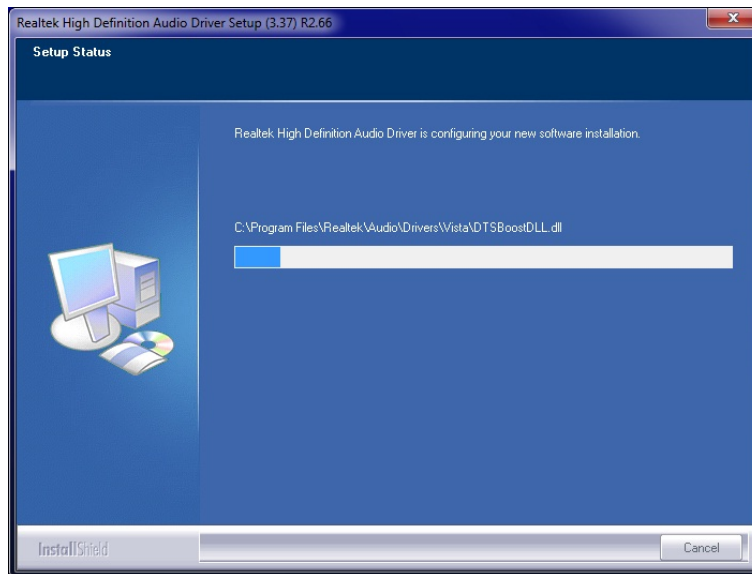

**Figure 6-25: Audio Driver Software Configuration**

**Step 8:** After the driver installation process is complete, a confirmation screen appears (Figure 6-26).

## IMBA-C2260-i2 ATX Motherboard

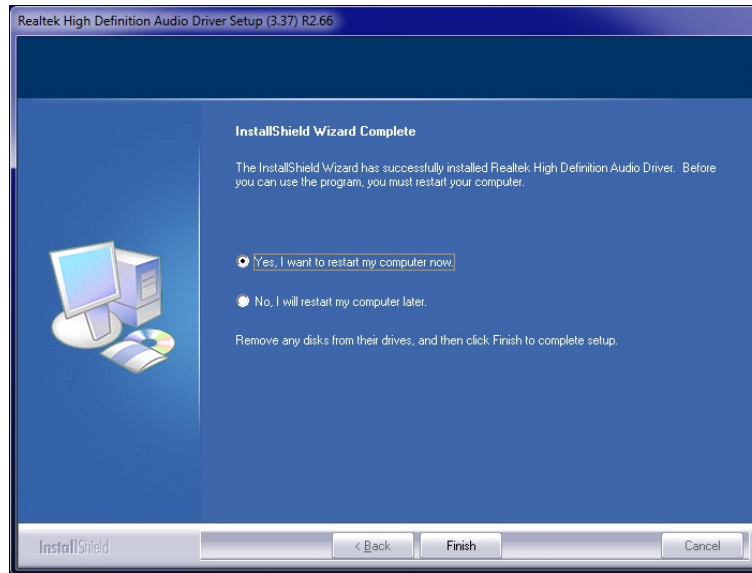

Figure 6-26: Restart the Computer

- Step 9:** The confirmation screen offers the option of restarting the computer now or later. For the settings to take effect, the computer must be restarted. Click **Finish** to restart the computer.

## 6.8 Intel® AMT Driver Installation

The package of the Intel® ME components includes

- Intel® Management Engine Interface (Intel® ME Interface)
- Intel® Dynamic Application Loader
- Intel® Identity Protection Technology (Intel® IPT)
- Serial Over LAN (SOL) driver
- Intel® Management and Security Status Application
- Local Manageability Service (LMS)

To install these Intel® ME components, please do the following.

- Step 1:** Access the driver list. (See **Section 6.2**)
- Step 2:** Click “7-iAMT Driver & Utility”.
- Step 3:** Double click the setup file in the **ME\_SW** folder.

**Step 4:** When the setup files are completely extracted the **Welcome Screen** in **Figure 6-27** appears.

**Step 5:** Click **Next** to continue.

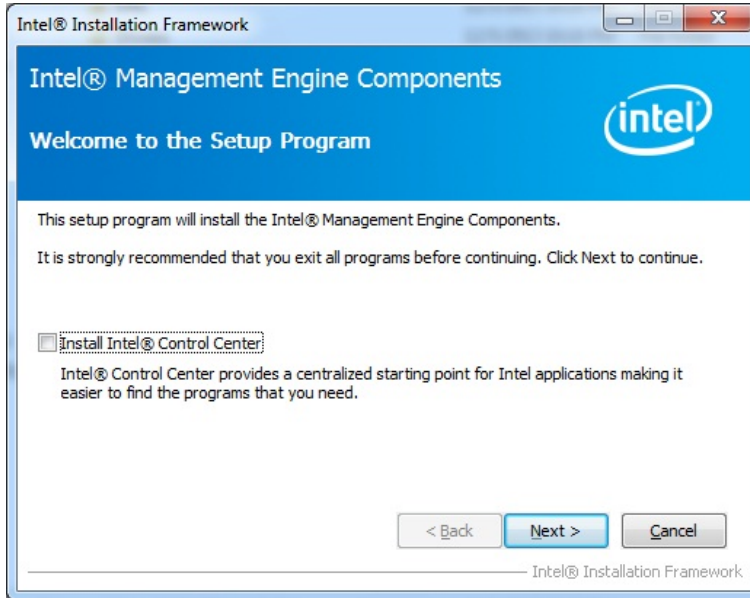

**Figure 6-27: Intel® ME Driver Welcome Screen**

**Step 6:** The license agreement in **Figure 6-28** appears.

**Step 7:** Read the **License Agreement**.

**Step 8:** Click **Yes** to continue.

IMBA-C2260-i2 ATX Motherboard

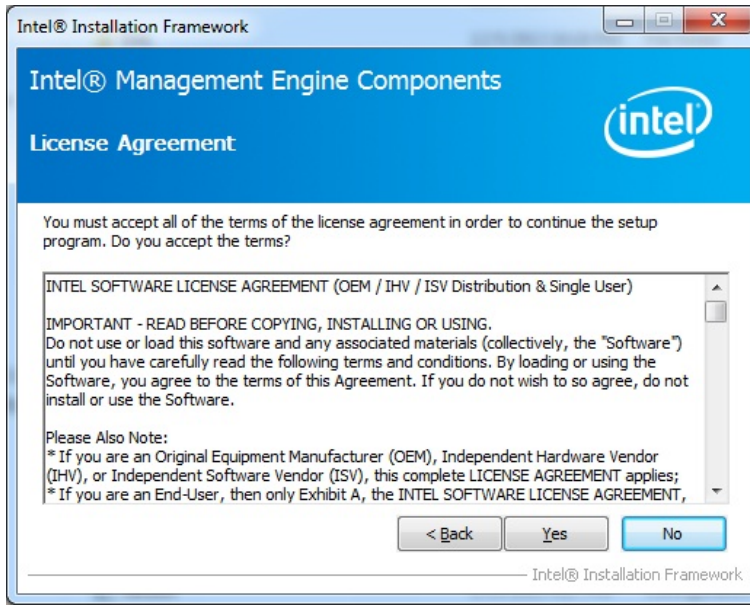

Figure 6-28: Intel® ME Driver License Agreement

**Step 9:** Setup Operations are performed as shown in Figure 6-29.

**Step 10:** Once the Setup Operations are complete, click Next to continue.

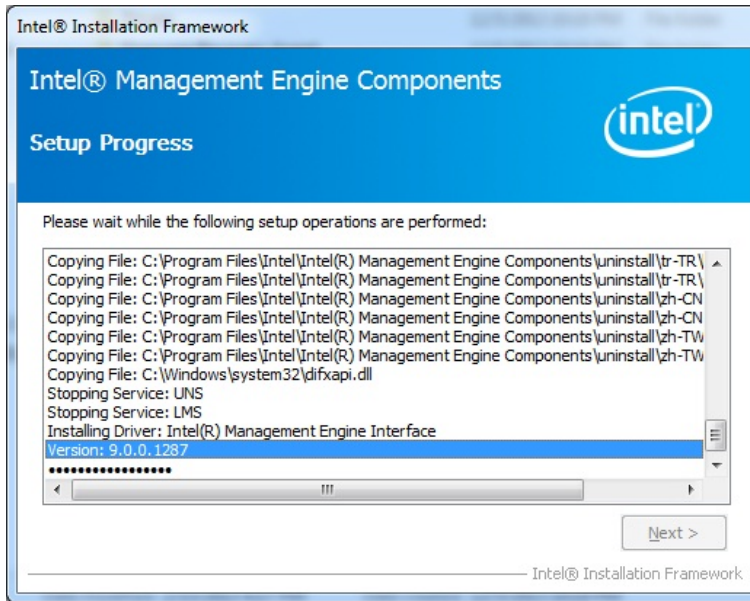
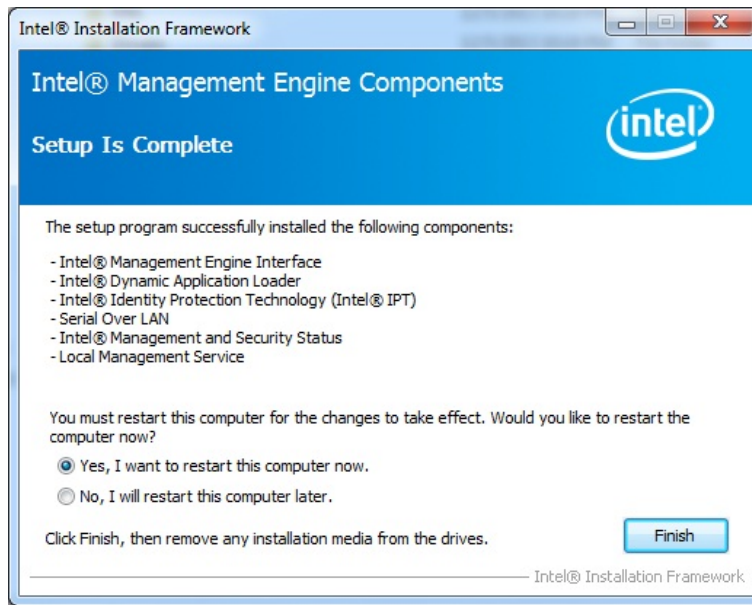

Figure 6-29: Intel® ME Driver Setup Operations

**Step 11:** The Finish screen in Figure 6-30 appears.

**Step 12:** Select “Yes, I want to restart this computer now” and click Finish.





**Figure 6-30: Intel® ME Driver Installation Finish Screen**

Appendix

**A**

# BIOS Options

---

Below is a list of BIOS configuration options in the BIOS chapter.

|   |           |
|---|-----------|
| <b>System Date [xx/xx/xx]</b> .....                     | <b>80</b> |
| <b>System Time [xx:xx:xx]</b> .....                     | <b>80</b> |
| <b>ACPI Sleep State [S1 only (CPU Stop Cl...]</b> ..... | <b>81</b> |
| <b>Wake system with Fixed Time [Disabled]</b> .....     | <b>82</b> |
| <b>Security Device Support [Disable]</b> .....          | <b>83</b> |
| <b>Hyper-threading [Enabled]</b> .....                  | <b>84</b> |
| <b>Active Processor Cores [All]</b> .....               | <b>85</b> |
| <b>Intel Virtualization Technology [Disabled]</b> ..... | <b>85</b> |
| <b>EIST [Enabled]</b> .....                             | <b>85</b> |
| <b>SATA Controller(s) [Enabled]</b> .....               | <b>86</b> |
| <b>SATA Mode Selection [IDE]</b> .....                  | <b>86</b> |
| <b>Intel(R) Rapid Start Technology [Disabled]</b> ..... | <b>87</b> |
| <b>Intel AMT [Enabled]</b> .....                        | <b>88</b> |
| <b>Un-Configure ME [Disabled]</b> .....                 | <b>88</b> |
| <b>USB Devices</b> .....                                | <b>89</b> |
| <b>Legacy USB Support [Enabled]</b> .....               | <b>89</b> |
| <b>Serial Port [Enabled]</b> .....                      | <b>91</b> |
| <b>Change Settings [Auto]</b> .....                     | <b>91</b> |
| <b>Serial Port [Enabled]</b> .....                      | <b>92</b> |
| <b>Change Settings [Auto]</b> .....                     | <b>92</b> |
| <b>Serial Port [Enabled]</b> .....                      | <b>93</b> |
| <b>Change Settings [Auto]</b> .....                     | <b>93</b> |
| <b>Serial Port [Enabled]</b> .....                      | <b>93</b> |
| <b>Change Settings [Auto]</b> .....                     | <b>94</b> |
| <b>Device Mode [RS422/485]</b> .....                    | <b>94</b> |
| <b>Serial Port [Enabled]</b> .....                      | <b>94</b> |
| <b>Change Settings [Auto]</b> .....                     | <b>94</b> |
| <b>Serial Port [Enabled]</b> .....                      | <b>95</b> |
| <b>Change Settings [Auto]</b> .....                     | <b>95</b> |
| <b>Parallel Port [Enabled]</b> .....                    | <b>96</b> |
| <b>Change Settings [Auto]</b> .....                     | <b>97</b> |
| <b>Device Mode [STD Printer Mode]</b> .....             | <b>97</b> |
| <b>PC Health Status</b> .....                           | <b>98</b> |

## IMBA-C2260-i2 ATX Motherboard

|   |     |
|---|-----|
| CPU_FAN1 Smart Fan Control/SYS_FAN1 Smart Fan Control [Auto Mode] ..... | 99  |
| Fan start/off temperature .....   | 99  |
| Fan start PWM .....   | 100 |
| Fan slope PWM .....   | 100 |
| Console Redirection [Disabled] .....                                    | 101 |
| Terminal Type [ANSI].....   | 102 |
| Bits per second [115200].....   | 102 |
| Data Bits [8] .....   | 102 |
| Parity [None].....  | 103 |
| Stop Bits [1].....  | 103 |
| Auto Recovery Function [Disabled].....                                  | 104 |
| Restore AC Power Loss [Last State] .....                                | 106 |
| Power Saving Function(ERP) [Disabled].....                              | 106 |
| PEG port configuration [1 x8, 2 x4 PCIE] .....                          | 107 |
| USB Power SW1 [+5V DUAL].....   | 107 |
| USB Power SW2 [+5V DUAL].....   | 107 |
| PCIe Speed [Gen1].....  | 109 |
| Detect Non-Compliance Device [Disabled] .....                           | 109 |
| Azalia (HD Audio) [Enabled] .....                                       | 110 |
| Primary Display [Auto] .....  | 112 |
| DVMT Pre-Allocated [256M] .....   | 112 |
| DVMT Total Gfx Mem [MAX].....   | 112 |
| Primary IGFX Boot Display [VBIOS Default] .....                         | 113 |
| PEG0 – Gen X [Auto] .....   | 114 |
| PEG1 – Gen X [Auto] .....   | 114 |
| PEG2 – Gen X [Auto] .....   | 115 |
| Enable PEG [Auto].....  | 115 |
| Detect Non-Compliance Device [Enabled] .....                            | 115 |
| Bootup NumLock State [On].....  | 117 |
| Quiet Boot [Enabled] .....  | 117 |
| Option ROM Messages [Force BIOS].....                                   | 117 |
| Launch PXE OpROM [Disabled] .....                                       | 118 |
| UEFI Boot [Disabled] .....  | 118 |
| Administrator Password .....  | 118 |
| User Password .....   | 119 |

|   |            |
|---|------------|
| <b>Save Changes and Reset .....</b>                     | <b>119</b> |
| <b>Discard Changes and Reset .....</b>                  | <b>119</b> |
| <b>Restore Defaults .....</b>                           | <b>119</b> |
| <b>Save as User Defaults .....</b>                      | <b>120</b> |
| <b>Restore User Defaults .....</b>                      | <b>120</b> |
| <b>SEL Components [Enabled].....</b>                    | <b>121</b> |
| <b>Erase SEL [No] .....</b>                             | <b>121</b> |
| <b>When SEL is Full [Do Nothing].....</b>               | <b>122</b> |
| <b>Log EFI Status Codes [Both] .....</b>                | <b>122</b> |
| <b>Configuration Address source [Unspecified] .....</b> | <b>123</b> |

Appendix

**B**

# Terminology

---

|               |   |
|---------------|---|
| <b>AC '97</b> | Audio Codec 97 (AC'97) refers to a codec standard developed by Intel® in 1997.  |
| <b>ACPI</b>   | Advanced Configuration and Power Interface (ACPI) is an OS-directed configuration, power management, and thermal management interface.  |
| <b>AHCI</b>   | Advanced Host Controller Interface (AHCI) is a SATA Host controller register-level interface.   |
| <b>ATA</b>    | The Advanced Technology Attachment (ATA) interface connects storage devices including hard disks and CD-ROM drives to a computer.   |
| <b>ARMD</b>   | An ATAPI Removable Media Device (ARMD) is any ATAPI device that supports removable media, besides CD and DVD drives.  |
| <b>ASKIR</b>  | Amplitude Shift Keyed Infrared (ASKIR) is a form of modulation that represents a digital signal by varying the amplitude (“volume”) of the signal. A low amplitude signal represents a binary 0, while a high amplitude signal represents a binary 1. |
| <b>BIOS</b>   | The Basic Input/Output System (BIOS) is firmware that is first run when the computer is turned on and can be configured by the end user   |
| <b>CODEC</b>  | The Compressor-Decompressor (CODEC) encodes and decodes digital audio data on the system.   |
| <b>CMOS</b>   | Complimentary metal-oxide-conductor is an integrated circuit used in chips like static RAM and microprocessors.   |
| <b>COM</b>    | COM refers to serial ports. Serial ports offer serial communication to expansion devices. The serial port on a personal computer is usually a male DB-9 connector.  |
| <b>DAC</b>    | The Digital-to-Analog Converter (DAC) converts digital signals to analog signals.   |
| <b>DDR</b>    | Double Data Rate refers to a data bus transferring data on both the rising and falling edges of the clock signal.   |
| <b>DMA</b>    | Direct Memory Access (DMA) enables some peripheral devices to bypass the system processor and communicate directly with the system memory.  |

**IMBA-C2260-i2 ATX Motherboard**

|                 |  |
|-----------------|--|
| <b>DIMM</b>     | Dual Inline Memory Modules are a type of RAM that offer a 64-bit data bus and have separate electrical contacts on each side of the module.  |
| <b>DIO</b>      | The digital inputs and digital outputs are general control signals that control the on/off circuit of external devices or TTL devices. Data can be read or written to the selected address to enable the DIO functions.                                  |
| <b>EHCI</b>     | The Enhanced Host Controller Interface (EHCI) specification is a register-level interface description for USB 2.0 Host Controllers.  |
| <b>EIDE</b>     | Enhanced IDE (EIDE) is a newer IDE interface standard that has data transfer rates between 4.0 MBps and 16.6 MBps.   |
| <b>EIST</b>     | Enhanced Intel® SpeedStep Technology (EIST) allows users to modify the power consumption levels and processor performance through application software. The application software changes the bus-to-core frequency ratio and the processor core voltage. |
| <b>FSB</b>      | The Front Side Bus (FSB) is the bi-directional communication channel between the processor and the Northbridge chipset.  |
| <b>GbE</b>      | Gigabit Ethernet (GbE) is an Ethernet version that transfers data at 1.0 Gbps and complies with the IEEE 802.3-2005 standard.  |
| <b>GPIO</b>     | General purpose input  |
| <b>HDD</b>      | Hard disk drive (HDD) is a type of magnetic, non-volatile computer storage device that stores digitally encoded data.  |
| <b>ICH</b>      | The Input/Output Control Hub (ICH) is an Intel® Southbridge chipset.   |
| <b>IrDA</b>     | Infrared Data Association (IrDA) specify infrared data transmission protocols used to enable electronic devices to wirelessly communicate with each other.   |
| <b>L1 Cache</b> | The Level 1 Cache (L1 Cache) is a small memory cache built into the system processor.  |
| <b>L2 Cache</b> | The Level 2 Cache (L2 Cache) is an external processor memory cache.  |
| <b>LCD</b>      | Liquid crystal display (LCD) is a flat, low-power display device that consists of two polarizing plates with a liquid crystal panel in between.  |



|                  |   |
|------------------|---|
| <b>LVDS</b>      | Low-voltage differential signaling (LVDS) is a dual-wire, high-speed differential electrical signaling system commonly used to connect LCD displays to a computer.  |
| <b>POST</b>      | The Power-on Self Test (POST) is the pre-boot actions the system performs when the system is turned-on.   |
| <b>RAM</b>       | Random Access Memory (RAM) is volatile memory that loses data when power is lost. RAM has very fast data transfer rates compared to other storage like hard drives.   |
| <b>SATA</b>      | Serial ATA (SATA) is a serial communications bus designed for data transfers between storage devices and the computer chipsets. The SATA bus has transfer speeds up to 1.5 Gbps and the SATA II bus has data transfer speeds of up to 3.0 Gbps. |
| <b>S.M.A.R.T</b> | Self Monitoring Analysis and Reporting Technology (S.M.A.R.T) refers to automatic status checking technology implemented on hard disk drives.   |
| <b>UART</b>      | Universal Asynchronous Receiver-transmitter (UART) is responsible for asynchronous communications on the system and manages the system's serial communication (COM) ports.  |
| <b>UHCI</b>      | The Universal Host Controller Interface (UHCI) specification is a register-level interface description for USB 1.1 Host Controllers.  |
| <b>USB</b>       | The Universal Serial Bus (USB) is an external bus standard for interfacing devices. USB 1.1 supports 12Mbps data transfer rates and USB 2.0 supports 480Mbps data transfer rates.   |
| <b>VGA</b>       | The Video Graphics Array (VGA) is a graphics display system developed by IBM.   |

Appendix

C

# Digital I/O Interface

---

## C.1 Introduction

The DIO connector on the IMBA-C2260-i2 is interfaced to GPIO ports on the Super I/O chipset. The DIO has both 4-bit digital inputs and 4-bit digital outputs. The digital inputs and digital outputs are generally control signals that control the on/off circuit of external devices or TTL devices. Data can be read or written to the selected address to enable the DIO functions.



### NOTE:

For further information, please refer to the datasheet for the Super I/O chipset.

---

The BIOS interrupt call **INT 15H** controls the digital I/O.

### INT 15H:

|                      |                                 |
|----------------------|---------------------------------|
| <b>AH – 6FH</b>      |                                 |
| <u>Sub-function:</u> |                                 |
| <b>AL – 8</b>        | : Set the digital port as INPUT |
| <b>AL</b>            | : Digital I/O input value       |

## IMBA-C2260-i2 ATX Motherboard

## C.2 Assembly Language Sample 1

```

MOV     AX, 6F08H      ;setting the digital port as input
INT     15H           ;

```

AL low byte = value

|  |
|--|
| <b>AH – 6FH</b>                                |
| <u>Sub-function:</u>                           |
| <b>AL – 9</b> : Set the digital port as OUTPUT |
| <b>BL</b> : Digital I/O input value            |

## C.3 Assembly Language Sample 2

```

MOV     AX, 6F09H      ;setting the digital port as output
MOV     BL, 09H        ;digital value is 09H
INT     15H           ;

```

Digital Output is 1001b

Appendix

**D**

# Watchdog Timer

---

## IMBA-C2260-i2 ATX Motherboard



### NOTE:

The following discussion applies to DOS environment. Contact IEI support or visit the IEI website for specific drivers for other operating systems.

The Watchdog Timer is provided to ensure that standalone systems can always recover from catastrophic conditions that cause the CPU to crash. This condition may have occurred by external EMIs or a software bug. When the CPU stops working correctly, Watchdog Timer either performs a hardware reset (cold boot) or a Non-Maskable Interrupt (NMI) to bring the system back to a known state.

A BIOS function call (INT 15H) is used to control the Watchdog Timer.

INT 15H:

| AH – 6FH Sub-function: |   |
|------------------------|---|
| AL – 2:                | Sets the Watchdog Timer's period.   |
| BL:                    | Time-out value (Its unit-second is dependent on the item "Watchdog Timer unit select" in CMOS setup). |

**Table D-1: AH-6FH Sub-function**

Call sub-function 2 to set the time-out period of Watchdog Timer first. If the time-out value is not zero, the Watchdog Timer starts counting down. When the timer value reaches zero, the system resets. To ensure that this reset condition does not occur, calling sub-function 2 must periodically refresh the Watchdog Timer. However, the watchdog timer is disabled if the time-out value is set to zero.

A tolerance of at least 10% must be maintained to avoid unknown routines within the operating system (DOS), such as disk I/O that can be very time-consuming.

**NOTE:**

When exiting a program it is necessary to disable the Watchdog Timer, otherwise the system resets.

**EXAMPLE PROGRAM:**

```
; INITIAL TIMER PERIOD COUNTER
```

```
;
```

```
W_LOOP:
```

```
;
```

```
    MOV     AX, 6F02H      ;setting the time-out value  
    MOV     BL, 30        ;time-out value is 48 seconds  
    INT     15H
```

```
;
```

```
; ADD THE APPLICATION PROGRAM HERE
```

```
;
```

```
    CMP     EXIT_AP, 1    ;is the application over?  
    JNE     W_LOOP       ;No, restart the application
```

```
    MOV     AX, 6F02H    ;disable Watchdog Timer  
    MOV     BL, 0        ;  
    INT     15H
```

```
;
```

```
; EXIT ;
```

Appendix

**E**

# Intel® Matrix Storage Manager

---



## E.1 Introduction

The IMBA-C2260-i2 can provide data protection for serial ATA (SATA) disks via the Intel® Matrix Storage Manager using one of three fault-tolerant RAID levels: RAID 1, 5 or 10. When using two hard drives, matrix RAID allows RAID 0 and RAID 1 functions to be combined, where critical files can be stored on RAID 1, and RAID 0 can be used for non-critical items such as software. RAID 5 and RAID 0 can be combined to provide higher performance, capacity, and fault tolerance.



### **CAUTION!**

A configured RAID volume (which may consist of multiple hard drives) appears to an operating system as a contingent storage space. The operating system will not be able to distinguish the physical disk drives contained in a RAID configuration.

---

### E.1.1 Precautions

One key benefit a RAID configuration brings is that a single hard drive can fail within a RAID array without damaging data. With RAID1 array, a failed drive can be replaced and the RAID configuration restored.



### **WARNING!**

Irrecoverable data loss occurs if a working drive is removed when trying to remove a failed drive. It is strongly recommended to mark the physical connections of all SATA disk drives. Drive locations can be identified by attaching stickers to the drive bays. If a drive member of a RAID array should fail, the failed drive can then be correctly identified.

---

## IMBA-C2260-i2 ATX Motherboard

---



### CAUTION!

Do not accidentally disconnect the SATA drive cables. Carefully route the cables within the chassis to avoid system down time.

---

## E.2 Features and Benefits

- Supports RAID levels 0, 1, 5 and 10
- Supports connectivity to two or more disk drives
- Supported Operating Systems include: Windows XP, Windows Server 2003, Windows Server 2008, Windows Vista and Windows 7

## E.3 Accessing the Intel® Matrix Storage Manager

To access the Intel® Matrix Storage Manager, please follow the steps below.

**Step 1: Connect SATA drives to the system.** Connect two or more SATA drives to the system. Make sure the drives have the same capacity, are the same type and have the same speed.

---



### NOTE:

Make sure the SATA drives are EXACTLY the same when they are configured in a RAID configuration. If they are not the same size, disk drive capacity is sacrificed and overall performance affected.

---

**Step 2: Enable SATA drives in BIOS.** Start the computer and access the BIOS setup program. Enable RAID support for all SATA devices. Refer to the applicable BIOS configuration section in this user manual.

**Step 3: Configure “Option ROM Messages” BIOS option to Force BIOS.** This is to allow the “Press <CTRL+I> to enter Configuration Utility.....” message to

appear during the POST. Refer to the applicable BIOS configuration section in this user manual.

- Step 4: Save and Exit BIOS.** After the SATA support option is enabled, save and exit the BIOS.
- Step 5: Reboot the system.** Reboot the system after saving and exiting the BIOS.
- Step 6: Press Ctrl+I. during the system boot process.** Press Ctrl+I when prompted to enter the RAID configuration software.
- Step 7: Configure the RAID settings.** Use the Intel® Matrix Storage Manager to configure the RAID array. Brief descriptions of configuration options are given below.

## E.4 Installing the Operating System to the RAID Array

To install the operating system to the RAID array some extra steps are necessary during the installation process.

- Step 1: Prepare a RAID driver floppy disk on another computer.** If installing on the RAID array a RAID driver floppy disk must be made. The RAID driver floppy disk utility is on the CD in the “5-SATA/Floppy Configuration Utility” folder. The floppy disk will be formatted and the drivers installed.
- Step 2: Restart the system with a floppy drive attached.** Attach a normal floppy drive or USB floppy drive to the system.
- Step 3: Press F6 when prompted.** During the installation process, Windows OS prompts the user to press F6 to install the RAID drivers. Press F6 and choose from the drivers on the floppy disk.
- Step 4: Install the OS.** Continue with OS installation as usual.

Appendix

F

# Hazardous Materials Disclosure

---

## **F.1 Hazardous Materials Disclosure Table for IPB Products Certified as RoHS Compliant Under 2002/95/EC Without Mercury**

The details provided in this appendix are to ensure that the product is compliant with the Peoples Republic of China (China) RoHS standards. The table below acknowledges the presences of small quantities of certain materials in the product, and is applicable to China RoHS only.

A label will be placed on each product to indicate the estimated “Environmentally Friendly Use Period” (EFUP). This is an estimate of the number of years that these substances would “not leak out or undergo abrupt change.” This product may contain replaceable sub-assemblies/components which have a shorter EFUP such as batteries and lamps. These components will be separately marked.

Please refer to the table on the next page.

## IMBA-C2260-i2 ATX Motherboard

| Part Name               | Toxic or Hazardous Substances and Elements |                       |                       |                              |                                |                                       |
|-------------------------|--|-----------------------|-----------------------|------------------------------|--------------------------------|---------------------------------------|
|                         | Lead (Pb)                                  | Mercury (Hg)          | Cadmium (Cd)          | Hexavalent Chromium (CR(VI)) | Polybrominated Biphenyls (PBB) | Polybrominated Diphenyl Ethers (PBDE) |
| Housing                 | <input type="radio"/>                      | <input type="radio"/> | <input type="radio"/> | <input type="radio"/>        | <input type="radio"/>          | <input type="radio"/>                 |
| Display                 | <input type="radio"/>                      | <input type="radio"/> | <input type="radio"/> | <input type="radio"/>        | <input type="radio"/>          | <input type="radio"/>                 |
| Printed Circuit Board   | <input type="radio"/>                      | <input type="radio"/> | <input type="radio"/> | <input type="radio"/>        | <input type="radio"/>          | <input type="radio"/>                 |
| Metal Fasteners         | <input type="radio"/>                      | <input type="radio"/> | <input type="radio"/> | <input type="radio"/>        | <input type="radio"/>          | <input type="radio"/>                 |
| Cable Assembly          | <input type="radio"/>                      | <input type="radio"/> | <input type="radio"/> | <input type="radio"/>        | <input type="radio"/>          | <input type="radio"/>                 |
| Fan Assembly            | <input type="radio"/>                      | <input type="radio"/> | <input type="radio"/> | <input type="radio"/>        | <input type="radio"/>          | <input type="radio"/>                 |
| Power Supply Assemblies | <input type="radio"/>                      | <input type="radio"/> | <input type="radio"/> | <input type="radio"/>        | <input type="radio"/>          | <input type="radio"/>                 |
| Battery                 | <input type="radio"/>                      | <input type="radio"/> | <input type="radio"/> | <input type="radio"/>        | <input type="radio"/>          | <input type="radio"/>                 |

O: This toxic or hazardous substance is contained in all of the homogeneous materials for the part is below the limit requirement in SJ/T11363-2006

X: This toxic or hazardous substance is contained in at least one of the homogeneous materials for this part is above the limit requirement in SJ/T11363-2006

此附件旨在确保本产品符合中国 RoHS 标准。以下表格标示此产品中某有毒物质的含量符合中国 RoHS 标准规定的限量要求。

本产品上会附有“环境友好使用期限”的标签，此期限是估算这些物质“不会有泄漏或突变”的年限。本产品可能包含有较短的环境友好使用期限的可替换元件，像是电池或灯管，这些元件将会单独标示出来。

| 部件名称   | 有毒有害物质或元素 |           |           |                 |               |                     |
|--------|-----------|-----------|-----------|-----------------|---------------|---------------------|
|        | 铅<br>(Pb) | 汞<br>(Hg) | 镉<br>(Cd) | 六价铬<br>(CR(VI)) | 多溴联苯<br>(PBB) | 多溴二苯<br>醚<br>(PBDE) |
| 壳体     | ○         | ○         | ○         | ○               | ○             | ○                   |
| 显示     | ○         | ○         | ○         | ○               | ○             | ○                   |
| 印刷电路板  | ○         | ○         | ○         | ○               | ○             | ○                   |
| 金属螺帽   | ○         | ○         | ○         | ○               | ○             | ○                   |
| 电缆组装   | ○         | ○         | ○         | ○               | ○             | ○                   |
| 风扇组装   | ○         | ○         | ○         | ○               | ○             | ○                   |
| 电力供应组装 | ○         | ○         | ○         | ○               | ○             | ○                   |
| 电池     | ○         | ○         | ○         | ○               | ○             | ○                   |

○: 表示该有毒有害物质在该部件所有物质材料中的含量均在 SJ/T11363-2006 标准规定的限量要求以下。  
 X: 表示该有毒有害物质至少在该部件的某一均质材料中的含量超出 SJ/T11363-2006 标准规定的限量要求。