

MODEL:
WAFER-ULT5

**3.5" SBC with 14nm Intel® Core™ i7/i5/i3 or Celeron® On-board SoC,
LVDS, HDMI, Triple PCIe GbE, USB 3.2 Gen 2, M.2, PCIe Mini,
SATA 6Gb/s, RS-232/422/485, Audio and RoHS**

User Manual

Revision

Date	Version	Changes
December 30, 2019	1.00	Initial release

Copyright

COPYRIGHT NOTICE

The information in this document is subject to change without prior notice in order to improve reliability, design and function and does not represent a commitment on the part of the manufacturer.

In no event will the manufacturer be liable for direct, indirect, special, incidental, or consequential damages arising out of the use or inability to use the product or documentation, even if advised of the possibility of such damages.

This document contains proprietary information protected by copyright. All rights are reserved. No part of this manual may be reproduced by any mechanical, electronic, or other means in any form without prior written permission of the manufacturer.

TRADEMARKS

All registered trademarks and product names mentioned herein are used for identification purposes only and may be trademarks and/or registered trademarks of their respective owners.

Manual Conventions



WARNING

Warnings appear where overlooked details may cause damage to the equipment or result in personal injury. Warnings should be taken seriously.



CAUTION

Cautionary messages should be heeded to help reduce the chance of losing data or damaging the product.



NOTE

These messages inform the reader of essential but non-critical information. These messages should be read carefully as any directions or instructions contained therein can help avoid making mistakes.

Table of Contents

1 INTRODUCTION.....	1
1.1 INTRODUCTION.....	2
1.2 MODEL VARIATIONS	3
1.3 FEATURES.....	3
1.4 CONNECTORS	4
1.5 DIMENSIONS.....	5
1.6 DATA FLOW	6
1.7 TECHNICAL SPECIFICATIONS	7
2 UNPACKING	9
2.1 ANTI-STATIC PRECAUTIONS	10
2.2 UNPACKING PRECAUTIONS.....	10
2.3 PACKING LIST.....	11
2.4 OPTIONAL ITEMS	12
3 CONNECTORS	13
3.1 PERIPHERAL INTERFACE CONNECTORS.....	14
3.1.1 WAFER-ULT5 Layout	14
3.1.2 Peripheral Interface Connectors	14
3.1.3 External Interface Panel Connectors.....	15
3.2 INTERNAL PERIPHERAL CONNECTORS	16
3.2.1 Audio Connector	16
3.2.2 Battery Connector.....	17
3.2.3 Digital I/O Connector	18
3.2.4 Fan Connector	19
3.2.5 Front Panel Connector	20
3.2.6 LAN LED Connectors	21
3.2.7 LVDS LCD Connector	21
3.2.8 LVDS Backlight Inverter Connector	23
3.2.9 M.2 Slot, A-key.....	24
3.2.10 DDR4 SO-DIMM Socket.....	26

3.2.11 PCIe Mini Card Slot, Full-size.....	26
3.2.12 Power Connector	28
3.2.13 Power Button Connector.....	29
3.2.14 Reset Button Connector	30
3.2.15 RS-232 Serial Port Connector	31
3.2.16 RS-232/422/485 Serial Port Connector	32
3.2.17 SATA 6Gb/s Drive Connector	33
3.2.18 SATA Power Connector.....	34
3.2.19 SMBus/I ² C Connector.....	35
3.2.20 SPI Flash Connector.....	36
3.2.21 USB 2.0 Connector	37
3.3 EXTERNAL PERIPHERAL INTERFACE CONNECTOR PANEL	38
3.3.1 HDMI Connectors.....	39
3.3.2 LAN Connectors.....	40
3.3.3 USB 3.2 Gen 2 Connectors	41
4 INSTALLATION	42
4.1 ANTI-STATIC PRECAUTIONS.....	43
4.2 INSTALLATION CONSIDERATIONS.....	43
4.3 SO-DIMM INSTALLATION	45
4.4 M.2 MODULE INSTALLATION.....	46
4.5 PCIe MINI CARD INSTALLATION	47
4.6 SYSTEM CONFIGURATION.....	48
4.6.1 AT/ATX Mode Select Switch.....	48
4.6.2 Clear CMOS Button.....	49
4.6.3 Flash Descriptor Security Override Jumper.....	50
4.6.4 LCD Voltage Selection	51
4.7 CHASSIS INSTALLATION.....	52
4.7.1 Heat Spreader	52
4.7.2 Motherboard Installation Example.....	53
4.8 INTERNAL PERIPHERAL DEVICE CONNECTIONS.....	54
4.8.1 AT Power Connection	54
4.8.2 7.1 Channel Audio Kit Installation	55
4.8.3 RS-232 Cable Connection.....	56
4.8.4 SATA Drive Connection	57

WAFER-ULT5 SBC

5 BIOS	59
5.1 INTRODUCTION.....	60
5.1.1 Starting Setup.....	60
5.1.2 Using Setup.....	60
5.1.3 Getting Help.....	61
5.1.4 Unable to Reboot after Configuration Changes.....	61
5.1.5 BIOS Menu Bar.....	61
5.2 MAIN.....	62
5.3 ADVANCED.....	63
5.3.1 CPU Configuration.....	64
5.3.2 PCH-FW Configuration.....	66
5.3.2.1 PTT Configuration.....	67
5.3.3 ACPI Settings.....	68
5.3.4 RTC Wake Settings.....	69
5.3.5 iWDD H/W Monitor.....	70
5.3.5.1 Smart Fan Mode Configuration.....	71
5.3.6 F81866 Super IO Configuration.....	73
5.3.6.1 Serial Port n Configuration.....	74
5.3.7 Serial Port Console Redirection.....	75
5.3.7.1 Legacy Console Redirection Settings.....	76
5.3.7.2 Console Redirection Settings.....	77
5.3.8 USB Configuration.....	79
5.3.9 NVMe Configuration.....	80
5.3.10 IEI Feature.....	81
5.4 CHIPSET.....	82
5.4.1 System Agent (SA) Configuration.....	82
5.4.1.1 Memory Configuration.....	83
5.4.1.2 Graphics Configuration.....	84
5.4.2 PCH-IO Configuration.....	86
5.4.2.1 PCI Express Configuration.....	88
5.4.2.1.1 MINI_PCIE1 / M2_A1 Configuration.....	88
5.4.2.2 SATA And RST Configuration.....	90
5.5 SECURITY.....	92
5.6 BOOT.....	93

5.7 EXIT	95
6 SOFTWARE DRIVERS	97
6.1 AVAILABLE DRIVERS	98
6.2 DRIVER DOWNLOAD	98
A REGULATORY COMPLIANCE	101
B PRODUCT DISPOSAL	103
C BIOS MENU OPTIONS.....	105
D DIGITAL I/O INTERFACE.....	108
E WATCHDOG TIMER.....	111
F ERROR BEEP CODE	114
F.1 PEI BEEP CODES	115
F.2 DXE BEEP CODES	115
G HAZARDOUS MATERIALS DISCLOSURE	116
G.1 RoHS II DIRECTIVE (2015/863/EU)	117
G.2 CHINA RoHS.....	118

List of Figures

Figure 1-1: WAFER-ULT5	2
Figure 1-2: Connectors	4
Figure 1-3: Dimensions (mm)	5
Figure 1-4: Data Flow Diagram	6
Figure 3-1: Connector and Jumper Locations	14
Figure 3-2: Audio Connector Location	16
Figure 3-3: Battery Connector Location	17
Figure 3-4: Digital I/O Connector Location	18
Figure 3-5: Fan Connector Location	19
Figure 3-6: Front Panel Connector Location	20
Figure 3-8: LAN LED Connector Locations	21
Figure 3-9: LVDS Connector Location	22
Figure 3-10: Backlight Inverter Connector Location	23
Figure 3-11: M.2 A-key Slot Location	24
Figure 3-13: DDR4 SO-DIMM Socket Location	26
Figure 3-14: Full-size PCIe Mini Card Slot Location	26
Figure 3-15: +12V DC-IN Power Connector Location	28
Figure 3-16: Power Button Connector Location	29
Figure 3-17: Reset Button Connector Location	30
Figure 3-18: RS-232 Serial Port Connector Location	31
Figure 3-19: RS-232/422/485 Connector Location	32
Figure 3-20: SATA 6Gb/s Drive Connectors Location	33
Figure 3-21: SATA Power Connector Location	34
Figure 3-22: SMBus Connector Location	35
Figure 3-24: SPI Flash Connector Location	36
Figure 3-26: USB Connector Location	37
Figure 3-27: External Peripheral Interface Connector	38
Figure 3-29: HDMI Connector Pinout Locations	39
Figure 3-30: LAN Connector	40
Figure 3-32: USB 3.2 Gen 2 Port Pinouts	41
Figure 4-1: SO-DIMM Installation	45

Figure 4-2: Inserting the M.2 Module into the Slot at an Angle	46
Figure 4-3: Securing the M.2 Module.....	46
Figure 4-4: Removing the Retention Screw	47
Figure 4-5: Inserting the Full-size PCIe Mini Card into the Slot at an Angle	47
Figure 4-6: Securing the Full-size PCIe Mini Card	48
Figure 4-10: AT/ATX Mode Select Switch	48
Figure 4-11: Clear CMOS Button Location.....	49
Figure 4-13: Flash Descriptor Security Override Jumper Location	50
Figure 4-14: LCD Voltage Selection Jumper Location.....	51
Figure 4-16: Heat Sink Retention Screws	53
Figure 4-17: Motherboard Installation Example	53
Figure 4-18: Power Cable to Motherboard Connection	54
Figure 4-19: Connect Power Cable to Power Supply.....	55
Figure 1-72: 7.1 Channel Audio Kit.....	56
Figure 4-21: Single RS-232 Cable Installation	57
Figure 4-22: SATA Drive Cable Connection.....	58
Figure 6-1: IEI Resource Download Center.....	98

List of Tables

Table 1-1: WAFER-ULT5 Model Variations	3
Table 1-2: Technical Specifications	8
Table 3-1: Peripheral Interface Connectors	15
Table 3-2: Rear Panel Connectors	16
Table 3-3: Audio Connector Pinouts	16
Table 3-4: Battery Connector Pinouts	18
Table 3-5: Digital I/O Connector Pinouts	18
Table 3-6: Fan Connector Pinouts	19
Table 3-7: Front Panel Connector Pinouts	20
Table 3-9: LAN LED Connector Pinouts	21
Table 3-10: LVDS Connector Pinouts	22
Table 3-11: Backlight Inverter Connector Pinouts	23
Table 3-12: M.2 A-Key Slot Pinouts	25
Table 3-14: Full-size PCIe Mini Card Slot Pinouts	27
Table 3-15: +12V DC-IN Power Connector Pinouts	28
Table 3-16: Power Button Connector Pinouts	29
Table 3-17: Reset Button Connector Pinouts	30
Table 3-18: RS-232 Serial Port Connector Pinouts	31
Table 3-19: RS-232/422/485 Serial Port Connector Pinouts	32
Table 3-18: DB-9 RS-232/422/485 Pinouts	33
Table 3-20: SATA Power Connector Pinouts	34
Table 3-21: SMBus Connector Pinouts	35
Table 3-22: SPI Flash Connector Pinouts	36
Table 3-24: USB Connector Pinouts	37
Table 3-26: HDMI Connector Pinouts	39
Table 3-27: LAN Pinouts	40
Table 3-28: LAN Connector LEDs	40
Table 3-30: USB 3.2 Gen 2 Port Pinouts	41
Table 4-3: Flash Descriptor Security Override Jumper Settings	50
Table 4-4: LCD Voltage Selection Jumper Settings	51

List of BIOS Menus

BIOS Menu 1: Main	62
BIOS Menu 2: Advanced	63
BIOS Menu 3: CPU Configuration	64
BIOS Menu 4: PCH-FW Configuration	66
BIOS Menu 3: PTT Configuration	67
BIOS Menu 6: ACPI Settings	68
BIOS Menu 7: RTC Wake Settings	69
BIOS Menu 8: iWDD H/W Monitor	70
BIOS Menu 9: Smart Fan Mode Configuration	71
BIOS Menu 10: F81866 Super IO Configuration	73
BIOS Menu 11: Serial Port n Configuration	74
BIOS Menu 12: Serial Port Console Redirection	75
BIOS Menu 13: Legacy Console Redirection Settings	76
BIOS Menu 14: Console Redirection Settings	77
BIOS Menu 15: USB Configuration	79
BIOS Menu 17: NVMe Configuration	80
BIOS Menu 18: IEI Feature	81
BIOS Menu 19: Chipset	82
BIOS Menu 20: System Agent (SA) Configuration	82
BIOS Menu 21: Memory Configuration	83
BIOS Menu 22: Graphics Configuration	84
BIOS Menu 23: PCH-IO Configuration	86
BIOS Menu 24: PCI Express Configuration	88
BIOS Menu 25: MINI_PCIE1 / M2_A1 Configuration	88
BIOS Menu 26: SATA and RST Configuration	90
BIOS Menu 27: Security	92
BIOS Menu 28: Boot	93
BIOS Menu 29: Exit	95

Chapter

1

Introduction

1.1 Introduction



Figure 1-1: WAFER-ULT5

The WAFER-ULT5 series is a 3.5" form factor single board computer. It has an on-board 8th generation 14nm Intel® Core™ i7/i5/i3 or Celeron® processor, and supports one 260-pin 2400 MHz dual-channel DDR4 SDRAM SO-DIMM slot with up to 32.0 GB of memory.

The WAFER-ULT5 series includes two HDMI connectors and an 18-/24-bit LVDS connector for triple independent display.

Expansion and I/O include one full-size PCIe Mini slot supporting mSATA modules, one M.2 A-key slot for expansions, four USB 3.2 Gen 2 connectors on the rear panel, two USB 2.0 connectors by pin header and one SATA 6Gb/s connector. Serial device connectivity is provided by one internal RS-232 connector and one internal RS-232/422/485 connector. Three RJ-45 GbE connectors provide the system with smooth connections to an external LAN.

WAFER-ULT5 SBC

1.2 Model Variations

The model variations of the WAFER-ULT5 series are listed below.

Model No.	SoC
WAFER-ULT5-i7	Intel® Core™ i7-8665UE on-board SoC (1.9 GHz, quad-core, 8 MB cache, TDP=15 W)
WAFER-ULT5-i5	Intel® Core™ i5-8365UE on-board SoC (1.6 GHz, quad-core, 6 MB cache, TDP=15 W)
WAFER-ULT5-i3	Intel® Core™ i3-8145UE on-board SoC (2.1 GHz, dual-core, 4 MB cache, TDP=15 W)
WAFER-ULT5-C	Intel® Celeron® 4305UE on-board SoC (2.2 GHz, dual-core, 2 MB cache, TDP=15 W)
WAFER-ULT5-CE	Intel® Celeron® 4205U on-board SoC (1.8 GHz, dual-core, 2 MB cache, TDP=15 W)

Table 1-1: WAFER-ULT5 Model Variations

1.3 Features

Some of the WAFER-ULT5 motherboard features are listed below:

- 3.5" SBC with 8th generation Intel® ULT processor
- Triple independent display via dual HDMI and LVDS
- One 260-pin 2400 MHz dual-channel DDR4 SO-DIMM slot (system max. 32 GB)
- Easy assembly heat spreader for thermal management
- Three RJ-45 Ethernet ports
- One M.2 2230 A-key slot for function expansions
- Full-size PCIe Mini card slot with mSATA support
- One SATA 6Gb/s connectors with power output
- Four USB 3.2 Gen 2 external connectors
- One RS-232 connector and one RS-232/422/485 connector

1.4 Connectors

The connectors on the WAFER-ULT5 are shown in the figure below.

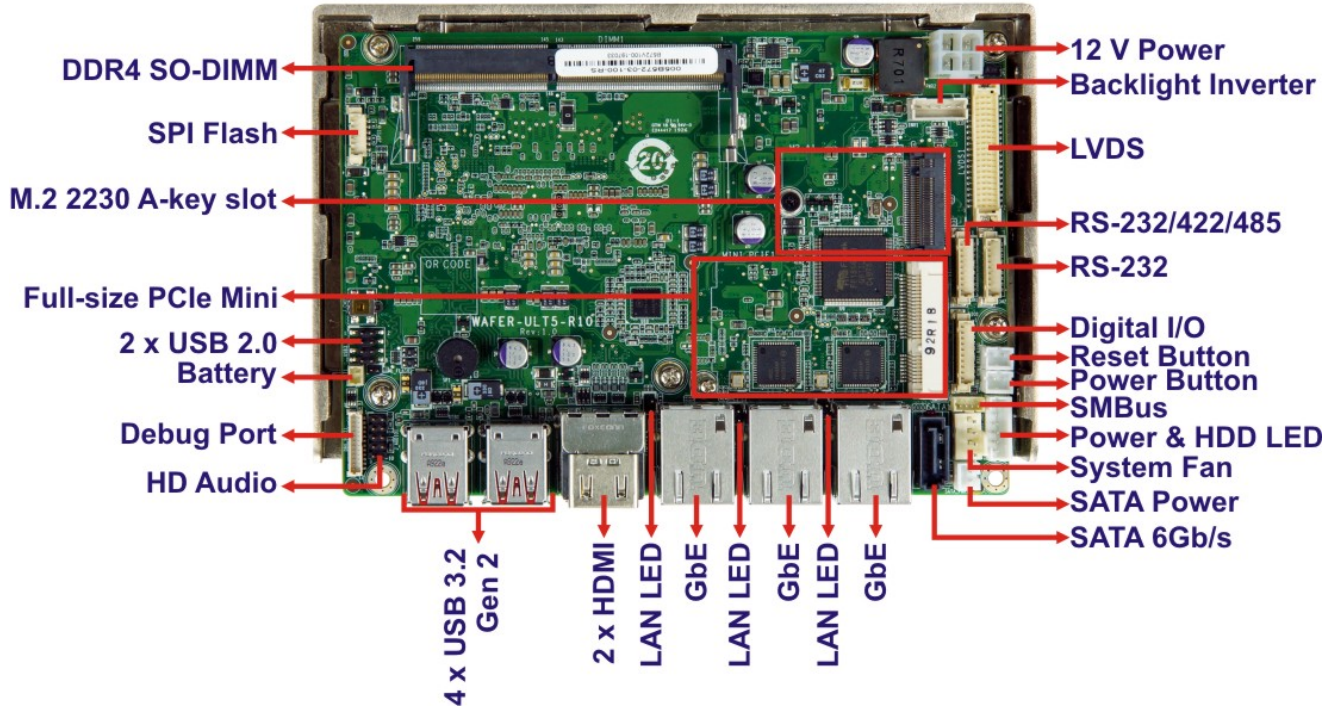

Figure 1-2: Connectors

WAFER-ULT5 SBC

1.5 Dimensions

The dimensions of the board are listed below:

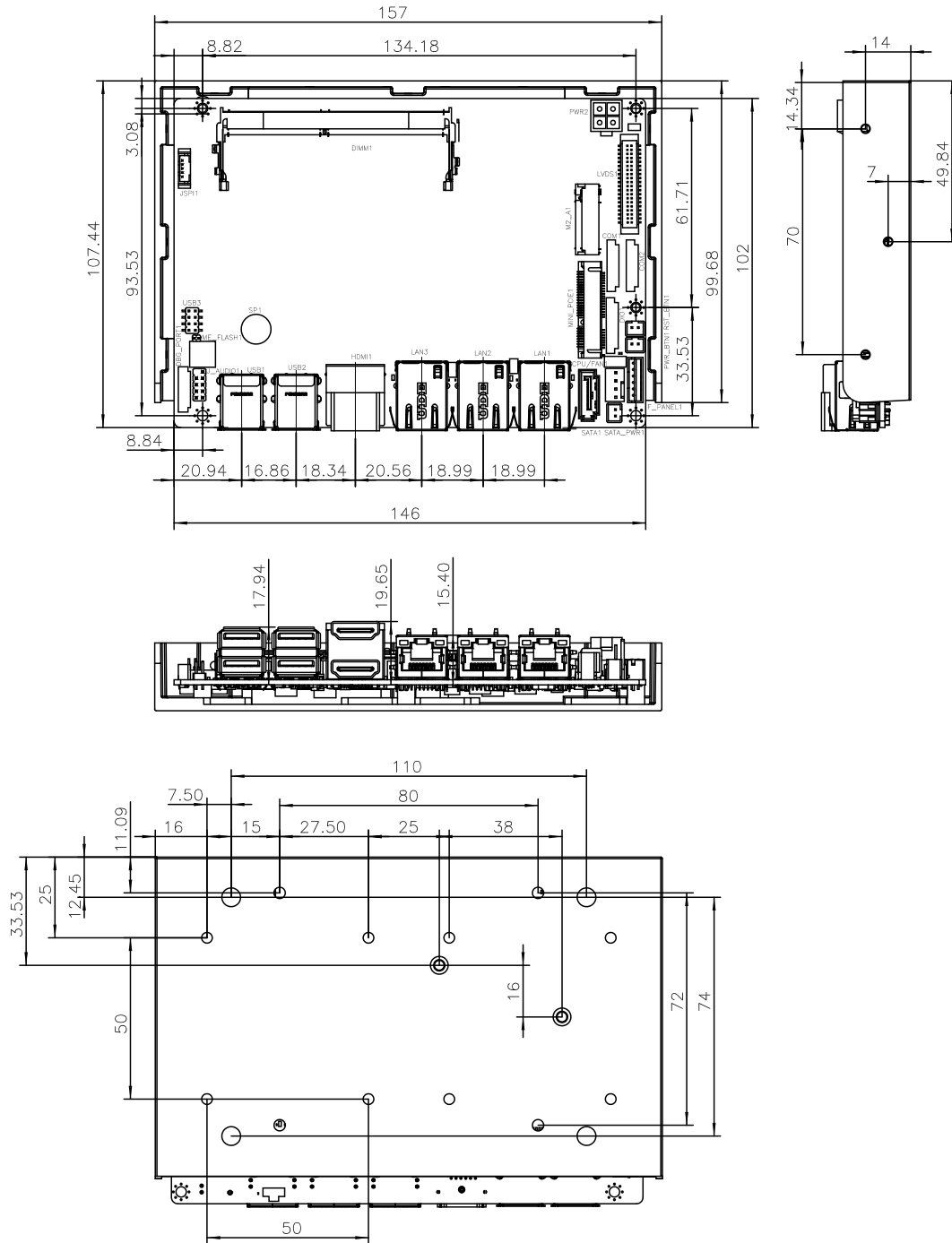

Figure 1-3: Dimensions (mm)

1.6 Data Flow

Figure 1-4 shows the data flow between the system chipset, the CPU and other components installed on the motherboard.

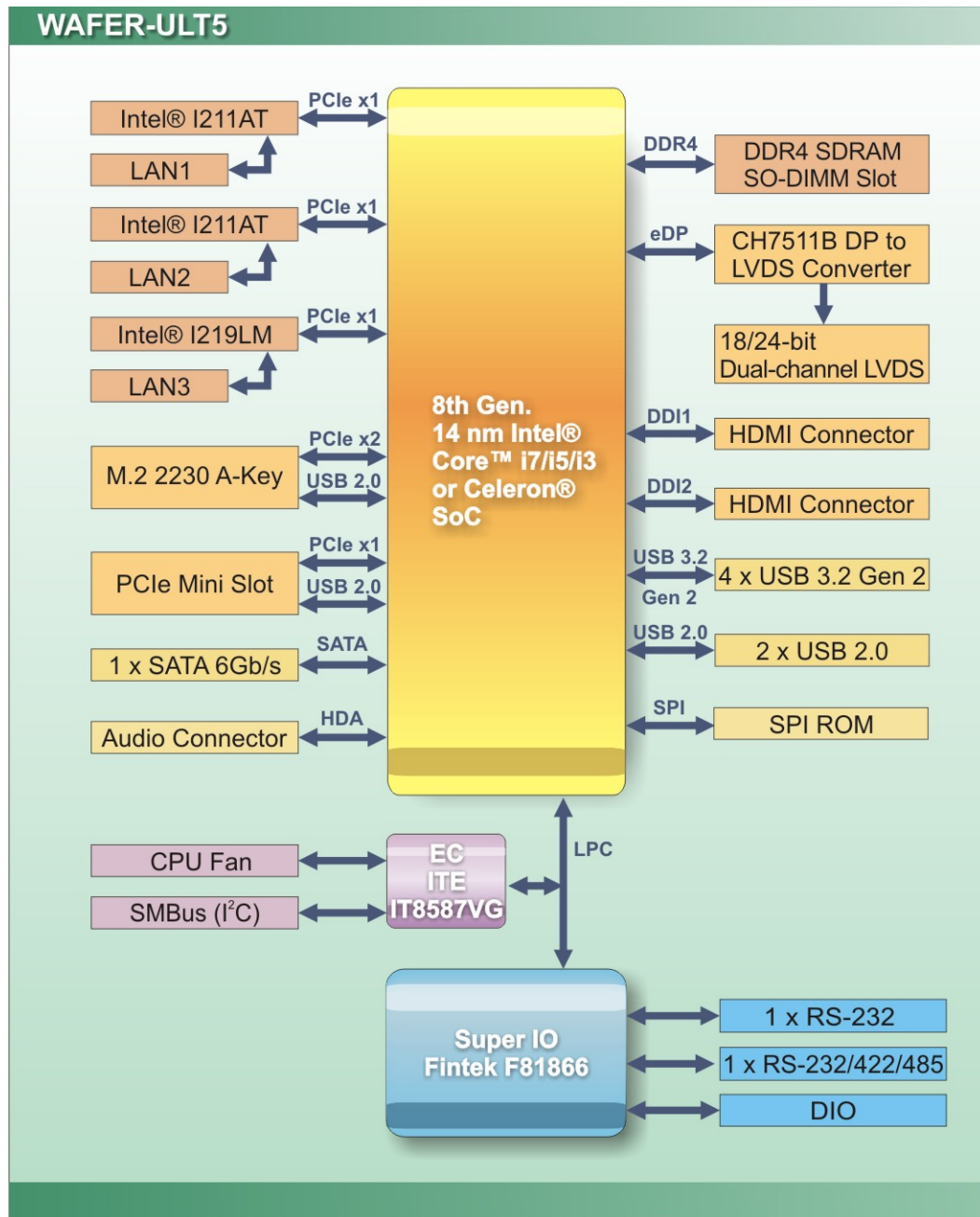

Figure 1-4: Data Flow Diagram

WAFER-ULT5 SBC

1.7 Technical Specifications

WAFER-ULT5 technical specifications are listed below.

Specification	WAFER-ULT5
SoC	8 th generation Intel® mobile ULT on-board SoC: <ul style="list-style-type: none"> ▪ Intel® Core™ i7-8665UE on-board SoC (1.9 GHz, quad-core, 8 MB cache, TDP=15 W) ▪ Intel® Core™ i5-8365UE on-board SoC (1.6 GHz, quad-core, 6 MB cache, TDP=15 W) ▪ Intel® Core™ i3-8145UE on-board SoC (2.1 GHz, dual-core, 4 MB cache, TDP=15 W) ▪ Intel® Celeron® 4305UE on-board SoC (2.2 GHz, dual-core, 2 MB cache, TDP=15 W) ▪ Intel® Celeron® 4205U on-board SoC (1.8 GHz, dual-core, 2 MB cache, TDP=15 W)
BIOS	AMI UEFI BIOS
Memory	One 260-pin 2400 MHz dual-channel DDR4 SO-DIMM slots (system max. 32 GB)
Graphics	Intel® UHD Graphics 620
Display Output	Triple independent display 2 x HDMI (up to 4096x2160@30Hz) 1 x 18/24-bit dual-channel LVDS by CH7511B DP to LVDS converter (up to 1920x1200@60Hz)
Ethernet	LAN1/LAN2: Intel® I211-AT PCIe GbE controller (colay with Intel® I210) LAN3: Intel® I219-LM PHY
Digital I/O	8-bit digital I/O by 10-pin (1x10) header
Super IO	Fintek F81866D-I
Embedded Controller	ITE IT8587VG
Watchdog Timer	Software programmable support 1~255 sec. system reset

I/O Interface	
Audio Connector	1 x HD Audio (2x5 pin, support 7.1 channel HD audio by AC-KIT-892HD-R10)
Ethernet	3 x RJ-45 GbE port
Serial Ports	1 x RS-232 by 9-pin (1x9) wafer 1 x RS-232/422/485 by 9-pin (1x9) wafer
USB Ports	4 x USB 3.2 Gen 2 on rear I/O 2 x USB 2.0 by 8-pin (2x4) header
Front Panel	1 x Power LED and HDD LED connector by 6-pin (1x6) wafer 1 x Power button connector by 2-pin wafer 1 x Reset button connector by 2-pin wafer
LAN LED	3 x LAN link LED connector by 2-pin header
Fan	1 x Smart fan connector by 4-pin (1x4) wafer
SMBus/I²C	1 x SMBus/I ² C connector by 4-pin (1x4) wafer
Storage	1 x SATA 6Gb/s with 5 V SATA power connectors
Expansions	1 x M.2 2230 A-key slot (USB 2.0 / PCIe x2) 1 x Full-size PCIe Mini card slot (PCIe x1 / USB 2.0 / SATA)
Environmental and Power Specifications	
Power Supply	12 V DC input only (AT/ATX support)
Power Connector	1 x Internal power connector by 4-pin (2x2) connector
Power Consumption	12V@3.38A (Intel® Core™ i7-8665UE CPU with two 16 GB 2666 MHz DDR4 memory modules)
Operating Temperature	-20°C ~ 60°C
Storage Temperature	-30°C ~ 70°C
Humidity	5% ~ 95%, non-condensing
Physical Specifications	
Dimensions	107mm x 157 mm
Weight GW/NW	600g / 250g

Table 1-2: Technical Specifications

Chapter

2

Unpacking

2.1 Anti-static Precautions



WARNING!

Static electricity can destroy certain electronics. Make sure to follow the ESD precautions to prevent damage to the product, and injury to the user.

Make sure to adhere to the following guidelines:

- **Wear an anti-static wristband:** Wearing an anti-static wristband can prevent electrostatic discharge.
- **Self-grounding:** Touch a grounded conductor every few minutes to discharge any excess static buildup.
- **Use an anti-static pad:** When configuring any circuit board, place it on an anti-static mat.
- **Only handle the edges of the PCB:** Don't touch the surface of the motherboard. Hold the motherboard by the edges when handling.

2.2 Unpacking Precautions

When the WAFER-ULT5 is unpacked, please do the following:

- Follow the antistatic guidelines above.
- Make sure the packing box is facing upwards when opening.
- Make sure all the packing list items are present.

WAFER-ULT5 SBC





2.3 Packing List



NOTE:



If any of the components listed in the checklist below are missing, do not proceed with the installation. Contact the IEI reseller or vendor the WAFER-ULT5 was purchased from or contact an IEI sales representative directly by sending an email to sales@ieiworld.com.

The WAFER-ULT5 is shipped with the following components:

Quantity	Item and Part Number	Image
1	WAFER-ULT5 single board computer	
1	Power cable	
2	RS-232/422/485 cable	
1	SATA with power cable kit	
1	Quick Installation Guide	

2.4 Optional Items

The following are optional components which may be separately purchased:

Item and Part Number	Image
RS-232 cable, 250 mm, p=1.25 (P/N : 32005-003500-200-RS)	
Audio kit, 7.1 Channel (P/N: AC-KIT-892HD-R10)	

Chapter

3

Connectors

3.1 Peripheral Interface Connectors

This chapter details all the jumpers and connectors.

3.1.1 WAFER-ULT5 Layout

The figures below show all the connectors and jumpers.

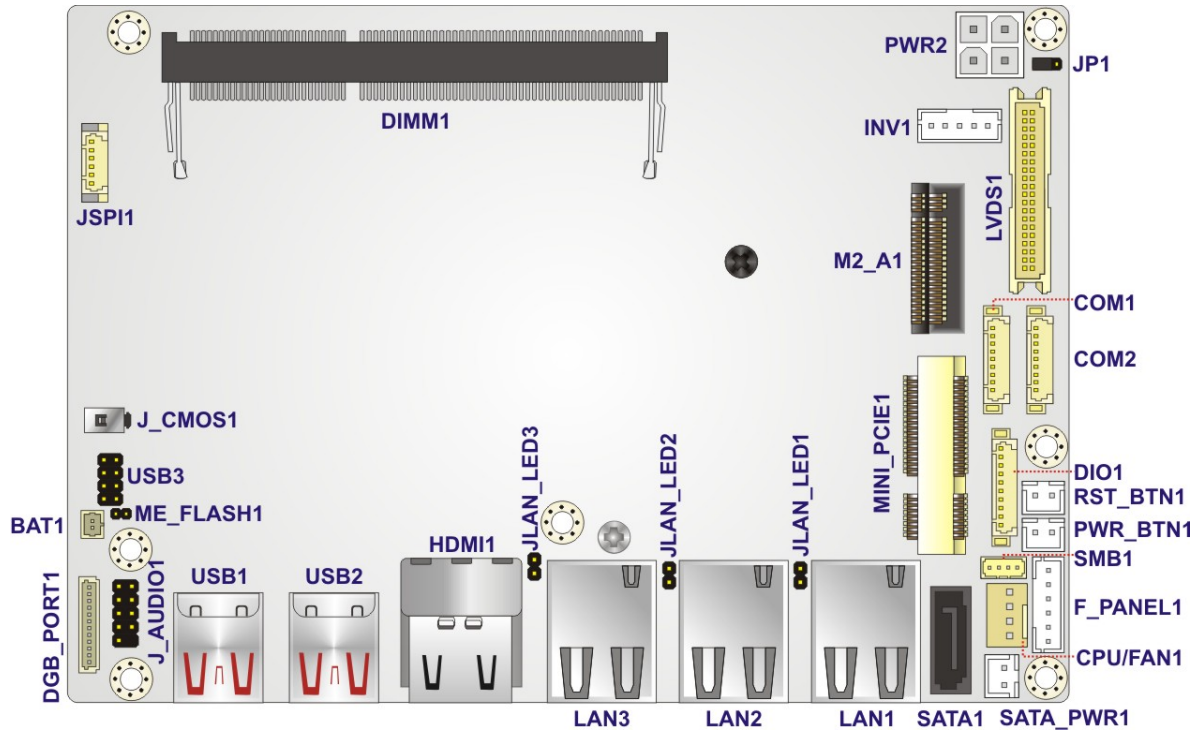

Figure 3-1: Connector and Jumper Locations

3.1.2 Peripheral Interface Connectors

The table below lists all the connectors on the board.

Connector	Type	Label
Audio connector	10-pin header	J_AUDIO1
Battery connector	2-pin wafer	BAT1
Debug port	12-pin wafer	DBG_PORT1
Digital I/O connector	10-pin wafer	DIO1

WAFFER-ULT5 SBC

Fan connector	4-pin wafer	CPU/FAN1
Front panel connector	6-pin wafer	F_PANEL1
LAN LED connector	2-pin header	JLAN_LED1, JLAN_LED2, JLAN_LED3
LVDS connector	40-pin crimp	LVDS1
LVDS backlight connector	5-pin wafer	INV1
M.2 2230 A-key slot	M.2 A-key slot	M2_A1
Memory module slot	260-pin DDR4 SO-DIMM	DIMM1
PCIe Mini card slot	Full-size PCIe Mini slot	MINI_PCIE1
Power connector	4-pin Molex	PWR2
Power button connector	2-pin wafer	PWR_BTN1
Reset button connector	2-pin wafer	RST_BTN1
RS-232 serial port connector	9-pin wafer	COM2
RS-232/422/485 serial port connector	9-pin wafer	COM1
Serial ATA connector	7-pin SATA connector	SATA1
SATA power connector	2-pin wafer	SATA_PWR1
SMBus/I ² C connector	4-pin wafer	SMB1
SPI flash connector	6-pin wafer	JSPI1
USB 2.0 connector	8-pin header	USB3

Table 3-1: Peripheral Interface Connectors

3.1.3 External Interface Panel Connectors

The table below lists the connectors on the external I/O panel.

Connector	Type	Label
HDMI connector	HDMI	HDMI1
LAN connectors	RJ-45	LAN1, LAN2, LAN3

USB 3.2 Gen 2 connectors	USB 3.2 Gen 2	USB1, USB2
--------------------------	---------------	------------

Table 3-2: Rear Panel Connectors

3.2 Internal Peripheral Connectors

The section describes all of the connectors on the WAFER-ULT5.

3.2.1 Audio Connector

- CN Label:** J_AUDIO1
- CN Type:** 10-pin header, p=2.00 mm
- CN Location:** See **Figure 3-2**
- CN Pinouts:** See **Table 3-3**

The audio connector is connected to external audio devices including speakers and microphones for the input and output of audio signals to and from the system.

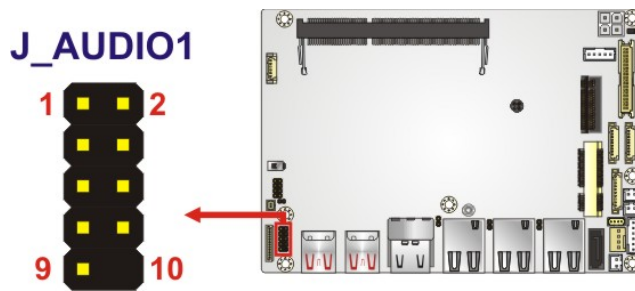

Figure 3-2: Audio Connector Location

PIN NO.	DESCRIPTION	PIN NO.	DESCRIPTION
1	HDA_SYNC	2	HAD_BCLK
3	HDA_SDO	4	HDA_PCBEEP
5	HAD_SDI0	6	HDA_RST#
7	+5V	8	GND
9	+12V	10	N/C

Table 3-3: Audio Connector Pinouts

WAFER-ULT5 SBC

3.2.2 Battery Connector



CAUTION:

Risk of explosion if battery is replaced by an incorrect type. Only certified engineers should replace the on-board battery.

Dispose of used batteries according to instructions and local regulations.



NOTE:

It is recommended to attach the RTC battery onto the system chassis in which the WAFER-ULT5 is installed.

CN Label:	BAT1
CN Type:	2-pin wafer, p=1.25 mm
CN Location:	See Figure 3-3
CN Pinouts:	See Table 3-4

The battery connector is connected to the system battery. The battery provides power to the system clock to retain the time when power is turned off.

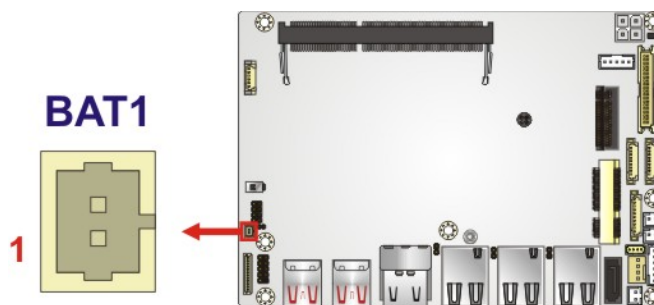

Figure 3-3: Battery Connector Location

Pin	Description
1	VBAT+
2	GND

Table 3-4: Battery Connector Pinouts

3.2.3 Digital I/O Connector

- CN Label:** DIO1
- CN Type:** 10-pin wafer, p=1.25 mm
- CN Location:** See **Figure 3-4**
- CN Pinouts:** See **Table 3-5**

The 8-bit digital I/O connector provides programmable input and output for external devices.

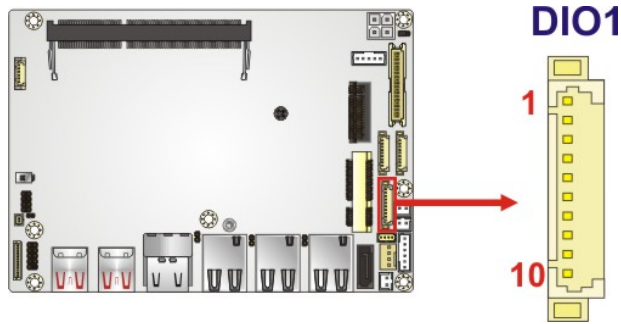

Figure 3-4: Digital I/O Connector Location

PIN NO.	DESCRIPTION	PIN NO.	DESCRIPTION
1	GND	6	DOUT0
2	+5V	7	DIN3
3	DOUT3	8	DIN2
4	DOUT2	9	DIN1
5	DOUT1	10	DIN0

Table 3-5: Digital I/O Connector Pinouts

WAFER-ULT5 SBC

3.2.4 Fan Connector

- CN Label:** CPU/FAN1
- CN Type:** 4-pin wafer, p=2.54 mm
- CN Location:** See **Figure 3-5**
- CN Pinouts:** See **Table 3-6**

The fan connector attaches to a smart cooling fan.

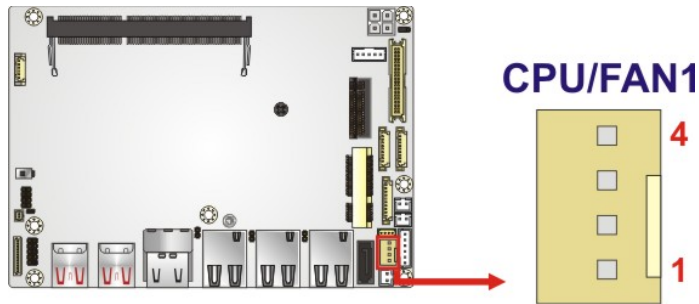

Figure 3-5: Fan Connector Location

Pin	Description
1	GND
2	+12V
3	Rotation Signal
4	PWM Control Signal

Table 3-6: Fan Connector Pinouts

3.2.5 Front Panel Connector

- CN Label:** F_PANEL1
- CN Type:** 6-pin wafer, p=2.00 mm
- CN Location:** See **Figure 3-6**
- CN Pinouts:** See **Table 3-7**

The front panel connector connects to the power LED indicator and HDD LED indicator on the system front panel.

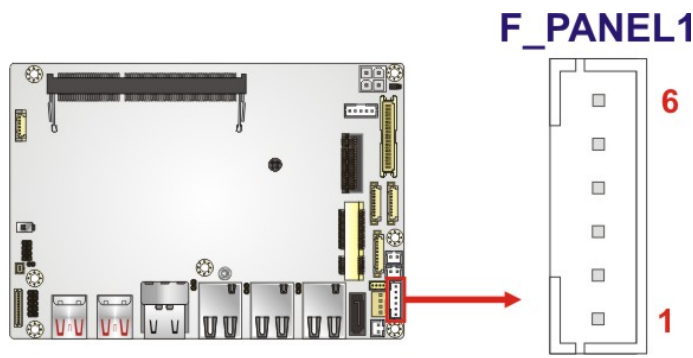

Figure 3-6: Front Panel Connector Location

Pin	Description
1	VCC
2	GND
3	PWR_LED+
4	PWR_LED-
5	HDD_LED+
6	HDD_LED-

Table 3-7: Front Panel Connector Pinouts

WAFER-ULT5 SBC

3.2.6 LAN LED Connectors

CN Label: JLAN_LED1, JLAN_LED2, JLAN_LED3

CN Type: 2-pin header, p=2.00 mm

CN Location: See **Figure 3-7**

CN Pinouts: See **Table 3-8**

The LAN LED connectors connect to the LAN link LEDs on the system.

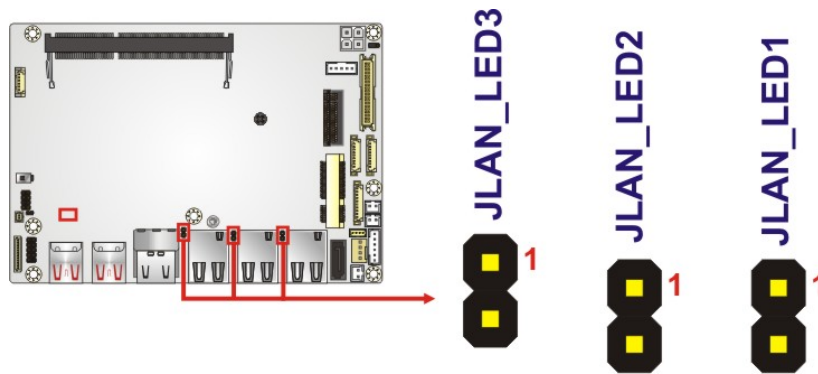

Figure 3-7: LAN LED Connector Locations

Pin	Description
1	LED+
2	LED-

Table 3-8: LAN LED Connector Pinouts

3.2.7 LVDS LCD Connector

CN Label: LVDS1

CN Type: 40-pin crimp, p=1.25 mm

CN Location: See **Figure 3-8**

CN Pinouts: See **Table 3-9**

The LVDS connector is for an LCD panel to connect to the board.

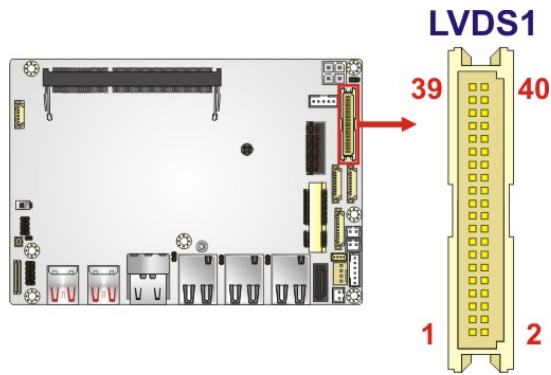

Figure 3-8: LVDS Connector Location

Pin	Description	Pin	Description
1	GROUND	2	GROUND
3	LVDS_A_TX0-N	4	LVDS_A_TX1-N
5	LVDS_A_TX0-P	6	LVDS_A_TX1-P
7	GROUND	8	GROUND
9	LVDS_A_TX2-N	10	LVDS_A_TXCLK-N
11	LVDS_A_TX2-P	12	LVDS_A_TXCLK-P
13	GROUND	14	GROUND
15	LVDS_A_TX3-N	16	LVDS_B_TX0-N
17	LVDS_A_TX3-P	18	LVDS_B_TX0-P
19	GROUND	20	GROUND
21	LVDS_B_TX1-N	22	LVDS_B_TX2-N
23	LVDS_B_TX1-P	24	LVDS_B_TX2-P
25	GROUND	26	GROUND
27	LVDS_B_TXCLK-N	28	LVDS_B_TX3-N
29	LVDS_B_TXCLK-P	30	LVDS_B_TX3-P
31	GROUND	32	GROUND
33	GROUND	34	GROUND
35	+LCD VCC	36	+LCD VCC
37	+LCD VCC	38	+LCD VCC
39	+LCD VCC	40	+LCD VCC

Table 3-9: LVDS Connector Pinouts

WAFER-ULT5 SBC

3.2.8 LVDS Backlight Inverter Connector

- CN Label:** INV1
- CN Type:** 5-pin wafer, p=2.00 mm
- CN Location:** See **Figure 3-9**
- CN Pinouts:** See **Table 3-10**

The backlight inverter connector provides power to an LCD panel.

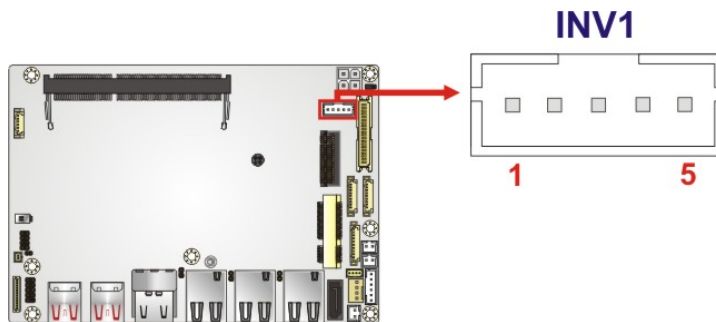

Figure 3-9: Backlight Inverter Connector Location

Pin	Description
1	LCD_BKLTCTL
2	GND
3	+12V
4	GND
5	BACKLIGHT_ENABLE

Table 3-10: Backlight Inverter Connector Pinouts

3.2.9 M.2 Slot, A-key

- CN Label:** M2_A1
- CN Type:** M.2 A-key slot
- CN Location:** See **Figure 3-10**
- CN Pinouts:** See **Table 3-11**

The M.2 slot is keyed in the A position and accepts 2230 size of M.2 modules. The M.2 slot supports PCIe x2 and USB 2.0 signals.

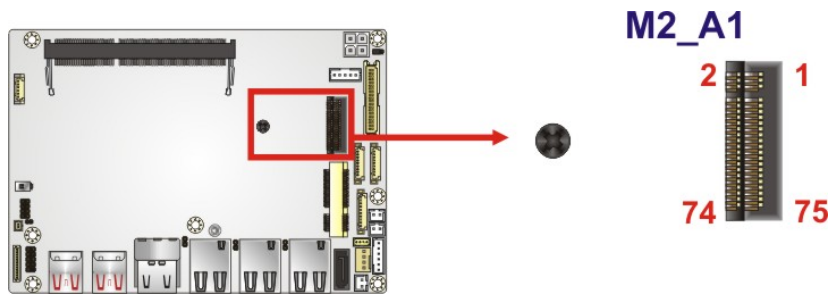

Figure 3-10: M.2 A-key Slot Location

Pin	Description	Pin	Description
1	GND	2	+V3.3A
3	USB+	4	+V3.3A
5	USB-	6	NC
7	GND	8	Module Key
9	Module Key	10	Module Key
11	Module Key	12	Module Key
13	Module Key	14	Module Key
15	Module Key	16	NC
17	NC	18	GND
19	NC	20	NC
21	NC	22	NC
23	GND	24	GND
25	NC	26	NC
27	NC	28	NC
29	GND	30	GND

WAFER-ULT5 SBC

Pin	Description	Pin	Description
31	NC	32	NC
33	GND	34	NC
35	PCIE_TX0+	36	GND
37	PCIE_TX0-	38	NC
39	GND	40	NC
41	PCIE_RX0+	42	NC
43	PCIE_RX0-	44	NC
45	GND	46	NC
47	CLK_PCIE0+	48	NC
49	CLK_PCIE0-	50	NC
51	GND	52	BUF_PLT_RST#
53	PCIE_CLKREQ#	54	Pull Up +V3.3A
55	PCIE_WAKE#	56	Pull Up +V3.3A
57	GND	58	NC
59	PCIE_TX1+	60	NC
61	PCIE_TX1-	62	NC
63	GND	64	NC
65	PCIE_RX1+	66	NC
67	PCIE_RX1-	68	NC
69	GND	70	NC
71	CLK_PCIE1+	72	+V3.3A
73	CLK_PCIE1-	74	+V3.3A
75	GND		

Table 3-11: M.2 A-Key Slot Pinouts

3.2.10 DDR4 SO-DIMM Socket

- CN Label:** DIMM1
- CN Type:** 260-pin DDR4 SO-DIMM socket
- CN Location:** See **Figure 3-11**

The SO-DIMM slot is for installing the DDR4 SO-DIMM.

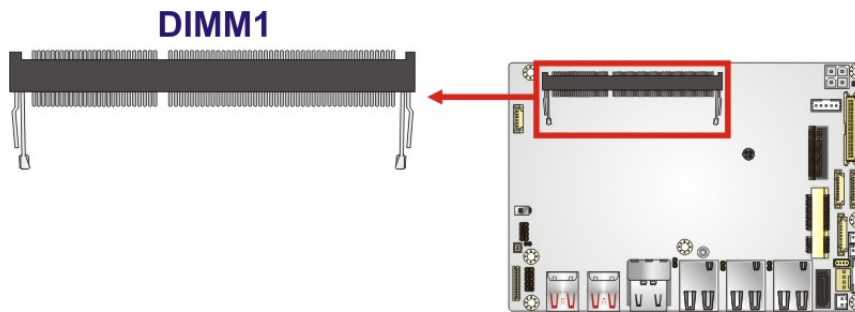

Figure 3-11: DDR4 SO-DIMM Socket Location

3.2.11 PCIe Mini Card Slot, Full-size

- CN Label:** MINI_PCIE1
- CN Type:** Full-size PCIe Mini card slot
- CN Location:** See **Figure 3-12**
- CN Pinouts:** See **Table 3-12**

The PCIe Mini card slot supports PCIe Mini cards with USB and PCIe interface such as 3G modules.

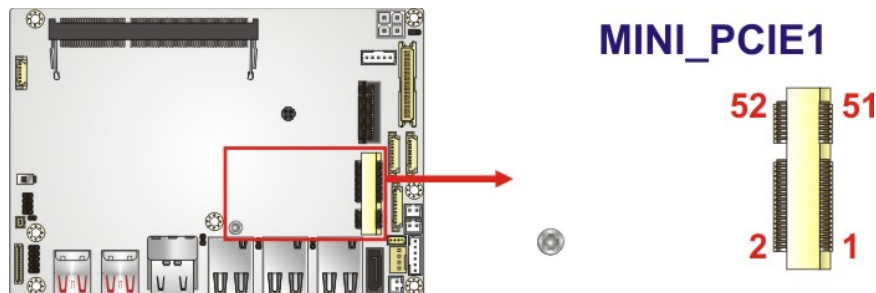

Figure 3-12: Full-size PCIe Mini Card Slot Location

WAFER-ULT5 SBC

Pin	Description	Pin	Description
1	PCIE_WAKE#	2	VCC3
3	N/C	4	GND
5	N/C	6	1.5V
7	N/C	8	N/C
9	GND	10	N/C
11	PCIE_CLK#	12	N/C
13	PCIE_CLK	14	N/C
15	GND	16	N/C
17	N/C	18	GND
19	N/C	20	N/C
21	GND	22	PCIRST#
23	PCIE_RXN	24	N/C
25	PCIE_RXP	26	GND
27	GND	28	1.5V
29	GND	30	SMBCLK
31	PCIE_TXN	32	SMBDATA
33	PCIE_TXP	34	GND
35	GND	36	USBD-
37	GND	38	USBD+
39	VCC3	40	GND
41	VCC3	42	N/C
43	GND	44	N/C
45	N/C	46	N/C
47	N/C	48	1.5V
49	N/C	50	GND
51	N/C	52	VCC3

Table 3-12: Full-size PCIe Mini Card Slot Pinouts

3.2.12 Power Connector

- CN Label:** PWR2
- CN Type:** 4-pin Molex, p=4.2 mm
- CN Location:** See **Figure 3-13**
- CN Pinouts:** See **Table 3-13**

The connector supports the +12V power supply.

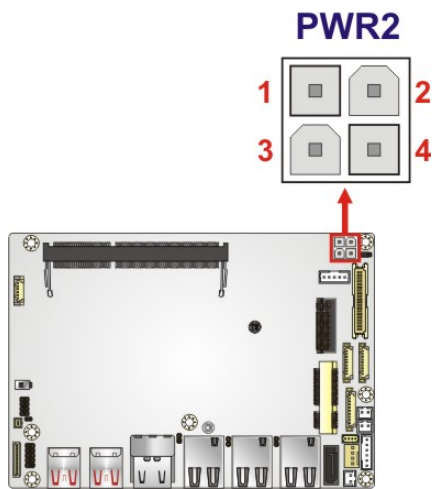

Figure 3-13: +12V DC-IN Power Connector Location

PIN NO.	DESCRIPTION	PIN NO.	DESCRIPTION
1	GND	2	GND
3	+12V	4	+12V

Table 3-13: +12V DC-IN Power Connector Pinouts

WAFER-ULT5 SBC

3.2.13 Power Button Connector

- CN Label:** PWR_BTN1
- CN Type:** 2-pin wafer, p=2.00 mm
- CN Location:** See **Figure 3-14**
- CN Pinouts:** See **Table 3-14**

The power button connector is connected to a power switch on the system chassis to enable users to turn the system on and off.

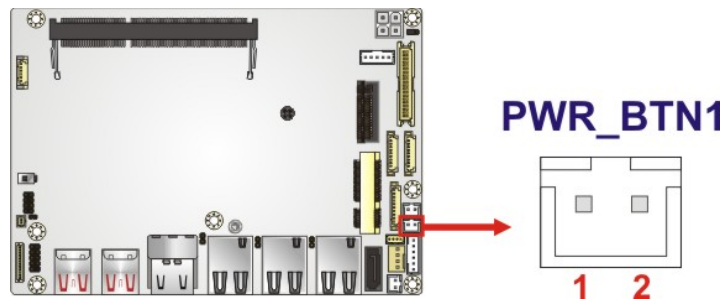

Figure 3-14: Power Button Connector Location

Pin	Description
1	PWR_BTN+
2	PWR_BTN-

Table 3-14: Power Button Connector Pinouts

3.2.14 Reset Button Connector

- CN Label:** RST_BTN1
- CN Type:** 2-pin wafer, p=2.00 mm
- CN Location:** See **Figure 3-15**
- CN Pinouts:** See **Table 3-15**

The reset button connector is connected to a reset switch on the system chassis to enable users to reboot the system when the system is turned on.

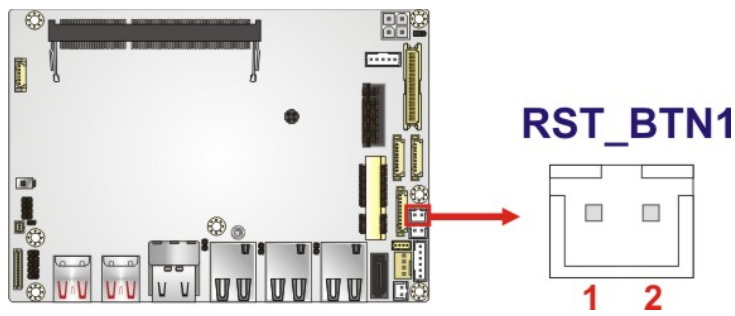

Figure 3-15: Reset Button Connector Location

Pin	Description
1	RESET+
2	RESET-

Table 3-15: Reset Button Connector Pinouts

WAFER-ULT5 SBC

3.2.15 RS-232 Serial Port Connector

- CN Label:** COM2
- CN Type:** 9-pin wafer, p=1.25 mm
- CN Location:** See **Figure 3-16**
- CN Pinouts:** See **Table 3-16**

The serial connector provides RS-232 connection.

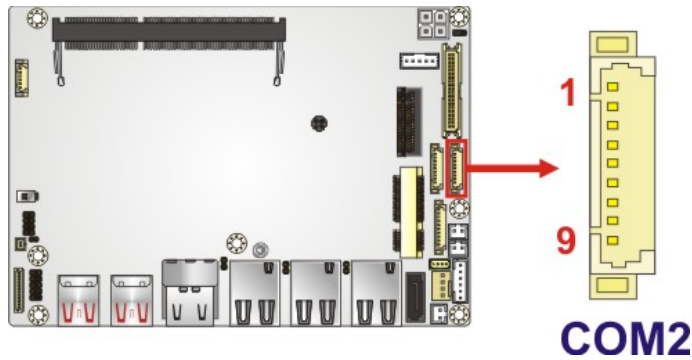

Figure 3-16: RS-232 Serial Port Connector Location

PIN NO.	DESCRIPTION	PIN NO.	DESCRIPTION
1	DCD	2	DSR
3	RXD	4	RTS
5	TXD	6	CTS
7	DTR	8	RI
9	GND		

Table 3-16: RS-232 Serial Port Connector Pinouts

3.2.16 RS-232/422/485 Serial Port Connector

- CN Label:** COM1
- CN Type:** 9-pin wafer, p=1.25 mm
- CN Location:** See **Figure 3-17**
- CN Pinouts:** See **Table 3-17**

This connector provides RS-232, RS-422 or RS-485 communications. The default mode is set to RS-232. To configure the connectors as RS-422 or RS-485, please refer to **Section 5.3.6.1**.

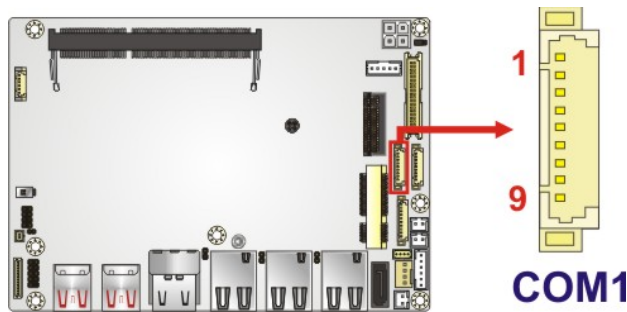

Figure 3-17: RS-232/422/485 Connector Location

Pin	RS-232	RS-422	RS-485
1	DCD	TXD-	DATA-
2	DSR	N/A	N/A
3	RXD	TXD+	DATA+
4	RTS	N/A	N/A
5	TXD	RXD+	N/A
6	CTS	N/A	N/A
7	DTR	RXD-	N/A
8	RI	N/A	N/A
9	GND	N/A	N/A

Table 3-17: RS-232/422/485 Serial Port Connector Pinouts

Use the optional RS-232/422/485 cable to connect to a serial device. The pinouts of the DB-9 connector are listed below.

WAFER-ULT5 SBC

Pin	RS-232	RS-422	RS-485
1	DCD	TXD422-	TXD485-
2	RXD	TXD422+	TXD485+
3	TXD	RXD422+	--
4	DTR	RXD422-	--
5	GND	--	--
6	DSR	--	--
7	RTS	--	--
8	CTS	--	--
9	RI	--	--

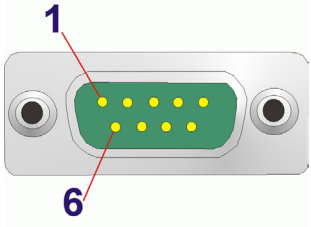

Table 3-18: DB-9 RS-232/422/485 Pinouts

3.2.17 SATA 6Gb/s Drive Connector

- CN Label:** SATA1
- CN Type:** 7-pin SATA connector
- CN Location:** See **Figure 3-18**

The SATA 6Gb/s drive connector is connected to a SATA 6Gb/s drive. The SATA 6Gb/s drive transfers data at speeds as high as 6Gb/s.

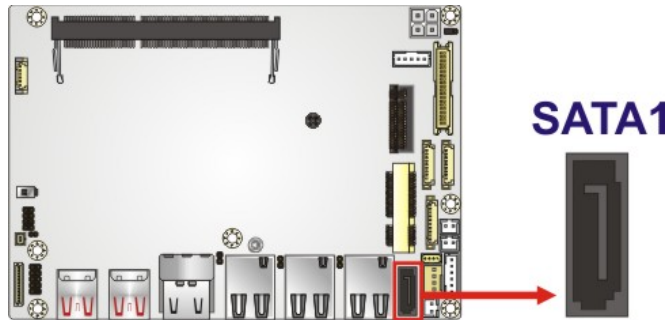

Figure 3-18: SATA 6Gb/s Drive Connectors Location

3.2.18 SATA Power Connector

- CN Label:** SATA_PWR1
- CN Type:** 2-pin wafer, p=2.00 mm
- CN Location:** See **Figure 3-19**
- CN Pinouts:** See **Table 3-19**

The SATA power connector provides +5 V power output to the SATA connector.

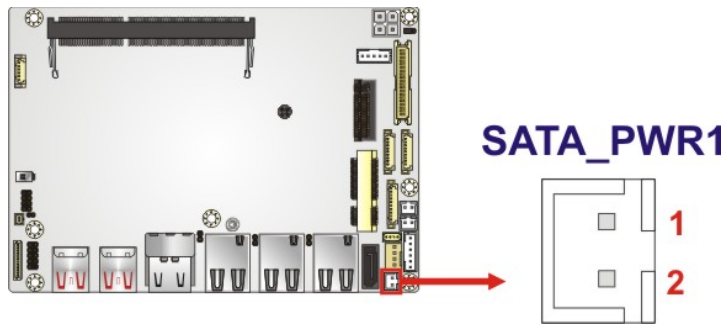

Figure 3-19: SATA Power Connector Location

Pin	Description
1	+5V
2	GND

Table 3-19: SATA Power Connector Pinouts

WAFER-ULT5 SBC

3.2.19 SMBus/I²C Connector

- CN Label:** SMB1
- CN Type:** 4-pin wafer, p=1.25 mm
- CN Location:** See **Figure 3-20**
- CN Pinouts:** See **Table 3-20**

The SMBus (System Management Bus) connector provides low-speed system management communications.

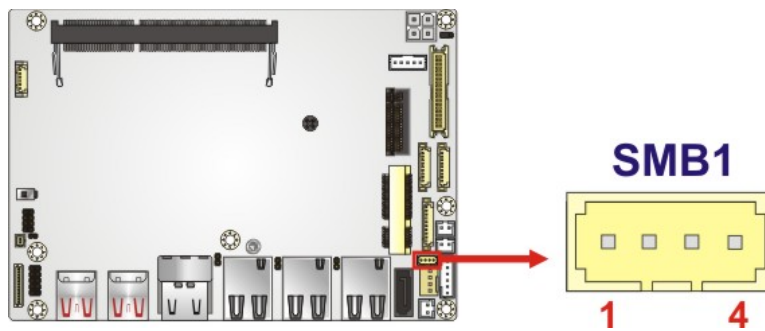

Figure 3-20: SMBus Connector Location

Pin	Description
1	GND
2	SMBus (I ² C) DATA
3	SMBus (I ² C) CLK
4	+5V

Table 3-20: SMBus Connector Pinouts

3.2.20 SPI Flash Connector

- CN Label:** JSPI1
- CN Type:** 6-pin wafer, p=1.25 mm
- CN Location:** See **Figure 3-21**
- CN Pinouts:** See **Table 3-21**

The 6-pin SPI Flash connector is used to flash the BIOS.

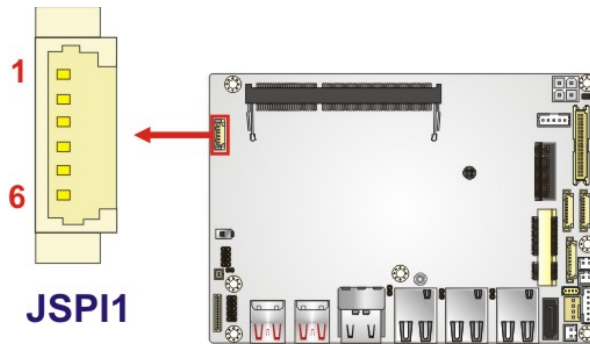

Figure 3-21: SPI Flash Connector Location

Pin	Description
1	+3.3V
2	SPI_CS#_SW
3	SPI_SO_SW
4	SPI_CLK_SW
5	SPI_SI_SW
6	GND

Table 3-21: SPI Flash Connector Pinouts

WAFER-ULT5 SBC

3.2.21 USB 2.0 Connector

- CN Label:** USB3
- CN Type:** 8-pin header, p=2.00 mm
- CN Location:** See **Figure 3-22**
- CN Pinouts:** See **Table 3-22**

The USB connector provides two USB 2.0 ports by dual-port USB cable.

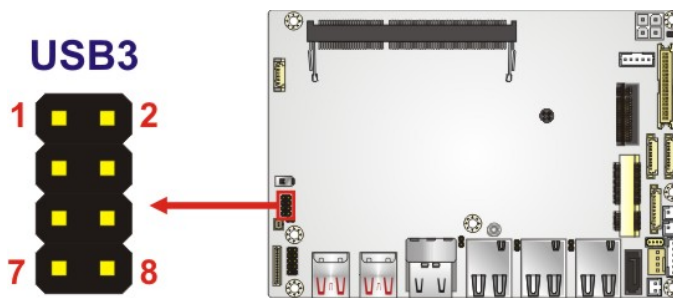

Figure 3-22: USB Connector Location

PIN NO.	DESCRIPTION	PIN NO.	DESCRIPTION
1	VCC	2	GND
3	DATA-	4	DATA+
5	DATA+	6	DATA-
7	GND	8	VCC

Table 3-22: USB Connector Pinouts

3.3 External Peripheral Interface Connector Panel

Figure 3-23 shows the WAFER-ULT5 external peripheral interface connector (EPIC) panel. The EPIC panel consists of the following:

- 2 x HDMI connector
- 3 x GbE RJ-45 connector
- 4 x USB 3.2 Gen 2 connector

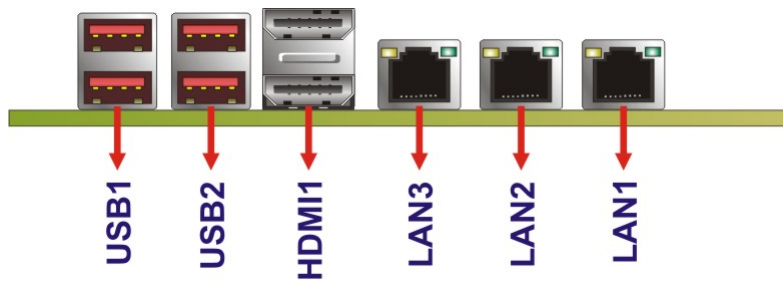

Figure 3-23: External Peripheral Interface Connector

WAFER-ULT5 SBC

3.3.1 HDMI Connectors

- CN Label:** HDMI1
- CN Type:** HDMI connector
- CN Location:** See **Figure 3-23**
- CN Pinouts:** See **Table 3-23** and **Figure 3-24**

The HDMI connectors can connect to HDMI devices.

Pin	Description	Pin	Description
1	HDMI_DATA2	2	GND
3	HDMI_DATA2#	4	HDMI_DATA1
5	GND	6	HDMI_DATA1#
7	HDMI_DATA0	8	GND
9	HDMI_DATA0#	10	HDMI_CLK
11	GND	12	HDMI_CLK#
13	N/C	14	N/C
15	HDMI_SCL	16	HDMI_SDA
17	GND	18	+5V
19	HDMI_HPD		

Table 3-23: HDMI Connector Pinouts

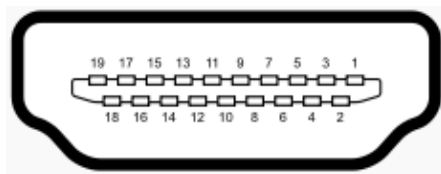

Figure 3-24: HDMI Connector Pinout Locations

3.3.2 LAN Connectors

- CN Label:** LAN1, LAN2, LAN3
- CN Type:** RJ-45
- CN Location:** See **Figure 3-23**
- CN Pinouts:** See **Figure 3-25** and **Table 3-24**

The LAN connector connects to a local network.

Pin	Description	Pin	Description
1	MDIA0+	5	MDIA2-
2	MDIA0-	6	MDIA1-
3	MDIA1+	7	MDIA3+
4	MDIA2+	8	MDIA3-

Table 3-24: LAN Pinouts

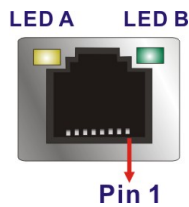

Figure 3-25: LAN Connector

LED	Description	LED	Description
A	on: linked blinking: data is being sent/received	B	off: 10 Mb/s green: 100 Mb/s orange: 1000 Mb/s

Table 3-25: LAN Connector LEDs

WAFER-ULT5 SBC

3.3.3 USB 3.2 Gen 2 Connectors

- CN Label:** USB1, USB2
- CN Type:** USB 3.2 Gen 2 port
- CN Location:** See **Figure 3-23**
- CN Pinouts:** See **Table 3-26** and **Figure 3-26**

The WAFER-ULT5 has four external USB 3.2 Gen 2 ports. The USB connector can be connected to a USB 2.0 or USB 3.2 device. The pinouts of USB 3.2 Gen 2 connectors are shown below.

Pin	Description	Pin	Description
1	USB_VCC	2	USB2_D0-
3	USB2_D0-	4	GND
5	USB3_RXD0-	6	USB3_RXD0+
7	GND	8	USB3_TXD0-
9	USB3_TXD0+	10	USB_VCC
11	USB2_D1-	12	USB2_D1+
13	GND	14	USB3_RXD1-
15	USB3_RXD1+	16	GND
17	USB3_TXD1-	18	USB3_TXD1+

Table 3-26: USB 3.2 Gen 2 Port Pinouts

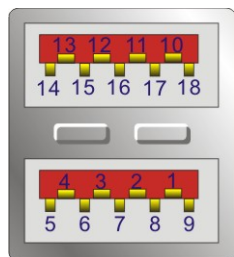

Figure 3-26: USB 3.2 Gen 2 Port Pinouts

Chapter

4

Installation

WAFER-ULT5 SBC

4.1 Anti-static Precautions



WARNING:

Failure to take ESD precautions during the installation of the WAFER-ULT5 may result in permanent damage to the WAFER-ULT5 and severe injury to the user.

Electrostatic discharge (ESD) can cause serious damage to electronic components, including the WAFER-ULT5. Dry climates are especially susceptible to ESD. It is therefore critical that whenever the WAFER-ULT5 or any other electrical component is handled, the following anti-static precautions are strictly adhered to.

- ***Wear an anti-static wristband:*** Wearing a simple anti-static wristband can help to prevent ESD from damaging the board.
- ***Self-grounding*** Before handling the board, touch any grounded conducting material. During the time the board is handled, frequently touch any conducting materials that are connected to the ground.
- ***Use an anti-static pad:*** When configuring the WAFER-ULT5, place it on an anti-static pad. This reduces the possibility of ESD damaging the WAFER-ULT5.
- ***Only handle the edges of the PCB:*** When handling the PCB, hold the PCB by the edges.

4.2 Installation Considerations



NOTE:

The following installation notices and installation considerations should be read and understood before installation. All installation notices must be strictly adhered to. Failing to adhere to these precautions may lead to severe damage and injury to the person performing the installation.

**WARNING:**

The installation instructions described in this manual should be carefully followed in order to prevent damage to the WAFER-ULT5, WAFER-ULT5 components and injury to the user.

Before and during the installation please **DO** the following:

- Read the user manual:
 - The user manual provides a complete description of the WAFER-ULT5 installation instructions and configuration options.
- Wear an electrostatic discharge cuff (ESD):
 - Electronic components are easily damaged by ESD. Wearing an ESD cuff removes ESD from the body and helps prevent ESD damage.
- Place the WAFER-ULT5 on an antistatic pad:
 - When installing or configuring the motherboard, place it on an antistatic pad. This helps to prevent potential ESD damage.
- Turn all power to the WAFER-ULT5 off:
 - When working with the WAFER-ULT5, make sure that it is disconnected from all power supplies and that no electricity is being fed into the system.

Before and during the installation of the WAFER-ULT5 **DO NOT:**

- Remove any of the stickers on the PCB board. These stickers are required for warranty validation.
- Use the product before verifying all the cables and power connectors are properly connected.
- Allow screws to come in contact with the PCB circuit, connector pins, or its components.

4.3 SO-DIMM Installation

To install an SO-DIMM, please follow the steps below and refer to **Figure 4-1**.

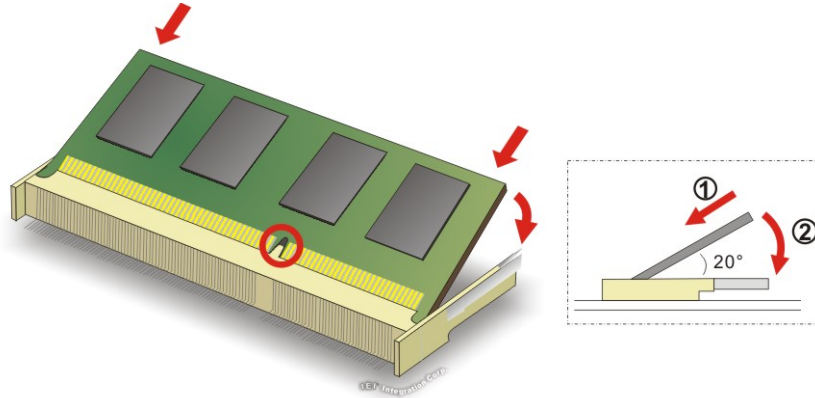

Figure 4-1: SO-DIMM Installation

- Step 1:** Locate the SO-DIMM socket. Place the board on an anti-static mat.
- Step 2:** Align the SO-DIMM with the socket. Align the notch on the memory with the notch on the memory socket.
- Step 3:** Insert the SO-DIMM. Push the memory in at a 20° angle. (See **Figure 4-1**)
- Step 4:** Seat the SO-DIMM. Gently push downwards and the arms clip into place. (See **Figure 4-1**)



CAUTION:

For dual channel configuration, always install two identical memory modules that feature the same capacity, timings, voltage, number of ranks and the same brand.

4.4 M.2 Module Installation

To install an M.2 module, please follow the steps below.

- Step 1:** Locate the M.2 module slot. See **Chapter 3**.
- Step 2:** Remove the retention screw secured on the motherboard.
- Step 3:** Line up the notch on the module with the notch on the slot. Slide the M.2 module into the socket at an angle of about 20° (**Figure 4-5**).

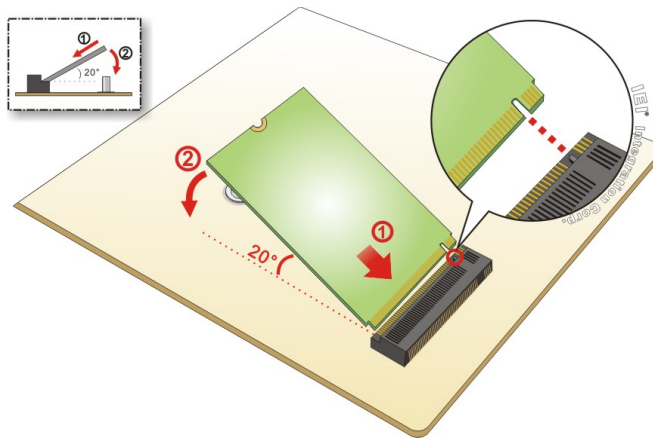

Figure 4-2: Inserting the M.2 Module into the Slot at an Angle

- Step 4:** Secure the M.2 module with the previously removed retention screw (**Figure 4-6**).

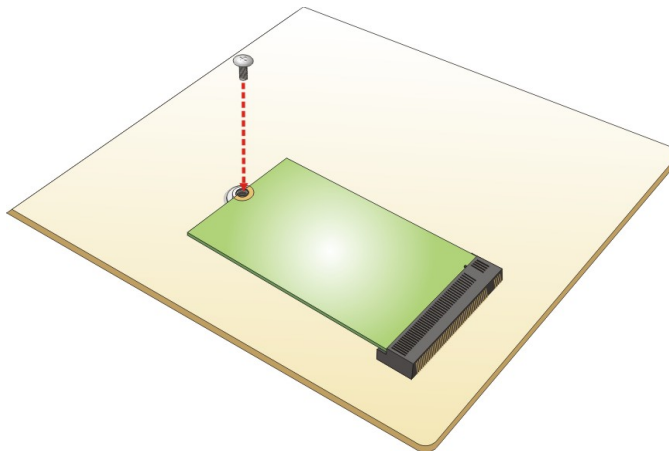

Figure 4-3: Securing the M.2 Module

WAFER-ULT5 SBC

4.5 PCIe Mini Card Installation

To install a full-size PCIe Mini card, please follow the steps below.

Step 1: Locate the full-size PCIe Mini card slot. See **Chapter 3**.

Step 2: Remove the retention screw as shown in **Figure 4-4**.

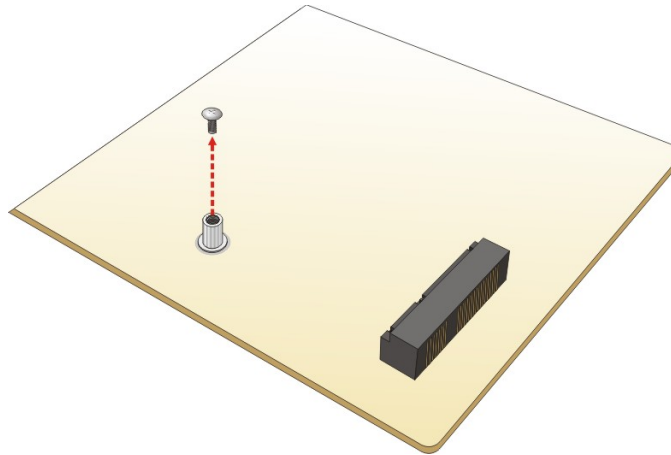

Figure 4-4: Removing the Retention Screw

Step 3: Line up the notch on the card with the notch on the slot. Slide the PCIe Mini card into the socket at an angle of about 20° (**Figure 4-5**).

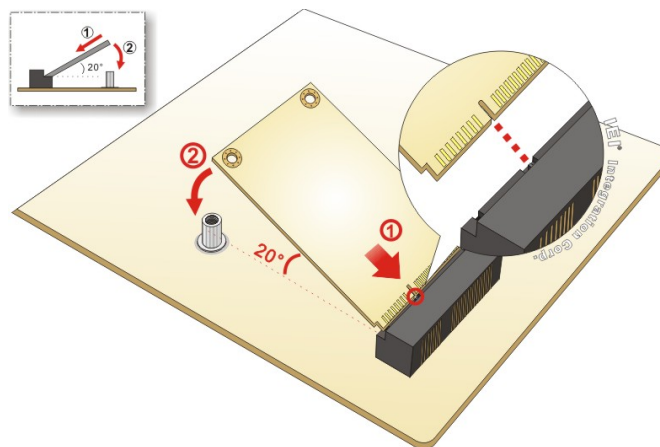

Figure 4-5: Inserting the Full-size PCIe Mini Card into the Slot at an Angle

Step 4: Secure the full-size PCIe Mini card with the retention screw previously removed (**Figure 4-6**).

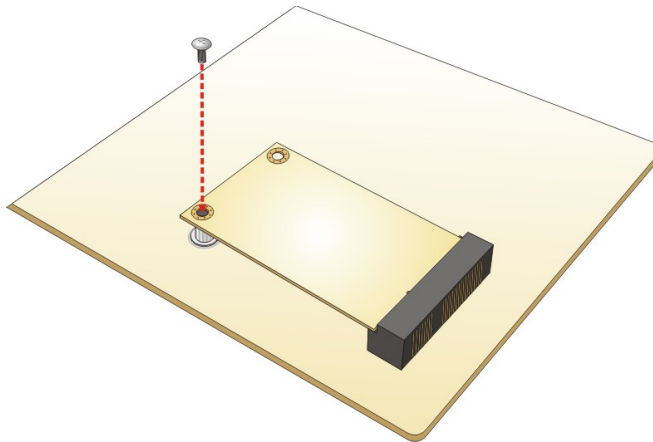

Figure 4-6: Securing the Full-size PCIe Mini Card

4.6 System Configuration

The system configuration is controlled by buttons, jumpers and switches. The system configuration should be performed before installation.

4.6.1 AT/ATX Mode Select Switch

The AT/ATX mode select switch specifies the systems power mode as AT or ATX. AT/ATX mode select switch settings are shown in **Figure 4-7** below.

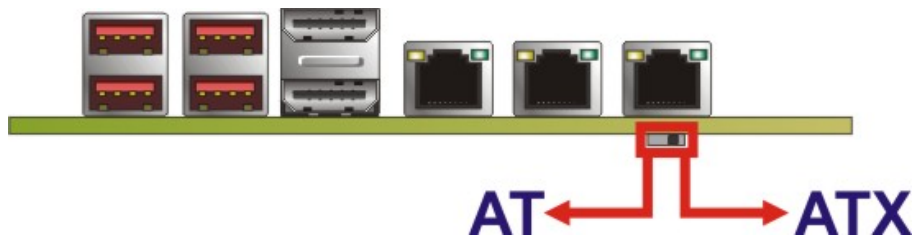

Figure 4-7: AT/ATX Mode Select Switch

WAFER-ULT5 SBC

4.6.2 Clear CMOS Button

CN Label:	J_CMOS1
CN Type:	Button
CN Location:	See Figure 4-8

If the WAFER-ULT5 fails to boot due to improper BIOS settings, use the button to clear the CMOS data and reset the system BIOS information.

The location of the clear CMOS button is shown in **Figure 4-8**

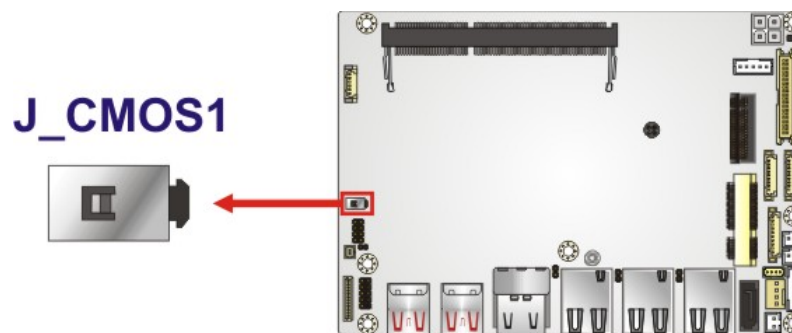

Figure 4-8: Clear CMOS Button Location

4.6.3 Flash Descriptor Security Override Jumper

CN Label:	ME_FLASH1
CN Type:	2-pin header, p=1.27 mm
CN Location:	See Figure 4-9
CN Settings:	See Table 4-1

The Flash Descriptor Security Override jumper (ME_FLASH1) allows to enable or disable the ME firmware update. Refer to **Figure 4-9** and **Table 4-1** for the jumper location and settings.

Setting	Description
Open	Disabled (Default)
Short	Enabled

Table 4-1: Flash Descriptor Security Override Jumper Settings

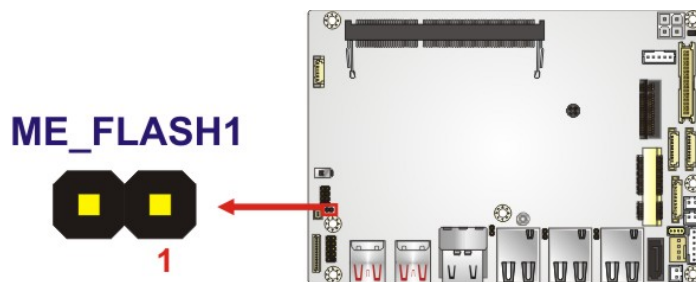

Figure 4-9: Flash Descriptor Security Override Jumper Location

To update the ME firmware, please follow the steps below.

- Step 1:** Before turning on the system power, short the Flash Descriptor Security Override jumper.
- Step 2:** Update the BIOS and ME firmware, and then turn off the system power.
- Step 3:** Remove the metal clip on the Flash Descriptor Security Override jumper to its default setting.

WAFER-ULT5 SBC

Step 4: Restart the system. The system will reboot 2 ~ 3 times to complete the ME firmware update.

4.6.4 LCD Voltage Selection



WARNING:

Incorrect voltages can destroy the LCD panel. Make sure to select a voltage that matches the voltage required by the LCD panel.

CN Label:	JP1
CN Type:	3-pin header, p=1.27 mm
CN Location:	See Figure 4-10
CN Settings:	See Table 4-2

The LCD voltage selection jumper sets the voltage of the power supplied to the LCD panel.

Setting	Description
Short 1-2	+3.3 V (Default)
Short 2-3	+5.0 V

Table 4-2: LCD Voltage Selection Jumper Settings

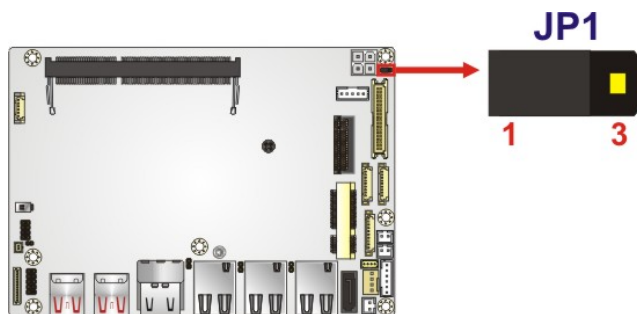

Figure 4-10: LCD Voltage Selection Jumper Location

4.7 Chassis Installation

4.7.1 Heat Spreader

**WARNING:**

The heat spreader installed on the WAFER-ULT5 can only serve as a heat conductor, which needs additional heat dissipation mechanism to achieve suitable thermal condition. DO NOT put the WAFER-ULT5 with the heat spreader directly on a surface that cannot dissipate system heat, and never run the WAFER-ULT5 without the heat spreader secured to the board.

When the WAFER-ULT5 is shipped, it is secured to a heat spreader with five retention screws. The heat spreader must have a direct contact with a heat dissipation surface to ensure stable operation. In addition, a thin layer of thermal paste has to be applied onto the heat dissipation surface where it contacts the heat spreader. The following diagrams show an example of a heat sink module and how it can be installed for dissipating the heat generated from the motherboard:

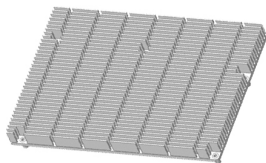
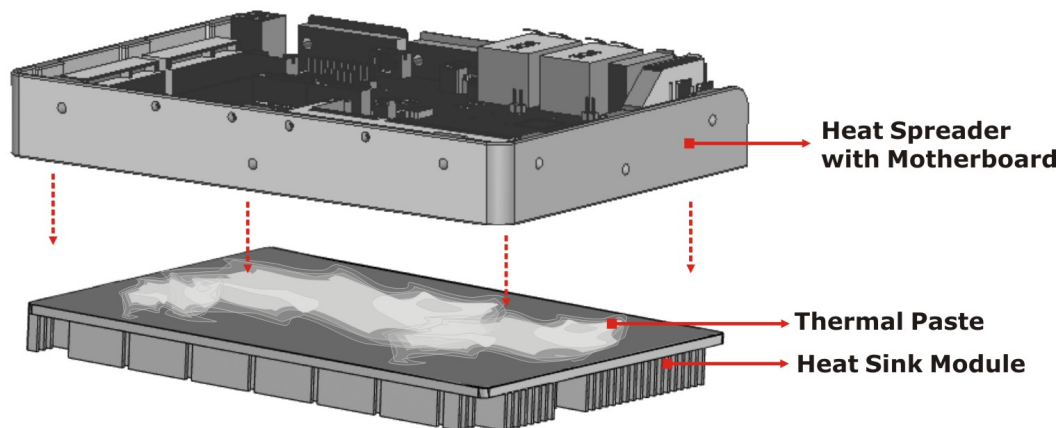
**Heat sink module:****Material:** Aluminum**Size:** 146 mm x 102 mm x 14.6 mm

WAFER-ULT5 SBC

If the WAFER-ULT5 must be removed from the heat spreader, the five retention screws must be removed.

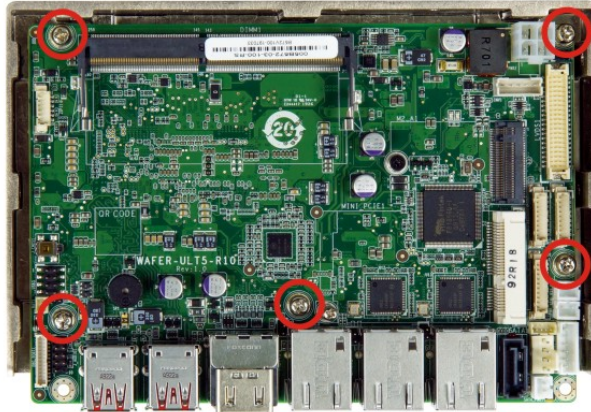

Figure 4-11: Heat Sink Retention Screws

4.7.2 Motherboard Installation Example

Each side of the heat spreader has several screw holes allowing the WAFER-ULT5 to be mounted into a chassis or a heat sink enclosure (please refer to Figure 1-3 for the detailed dimensions). The user has to design or select a chassis or a heat sink enclosure that has screw holes matching up with the holes on the heat spreader for installing the WAFER-ULT5. The following diagram shows an example of motherboard installation.

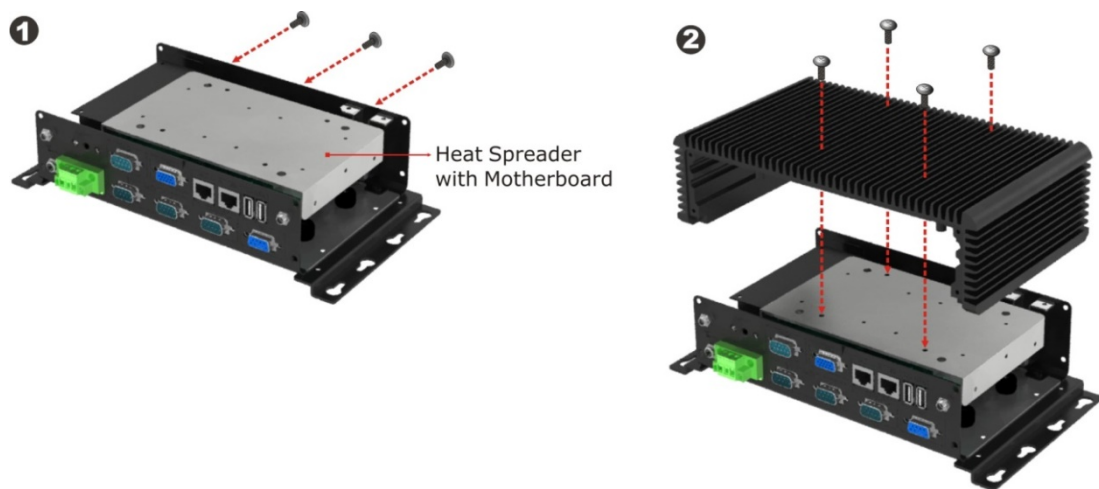

Figure 4-12: Motherboard Installation Example

4.8 Internal Peripheral Device Connections

This section outlines the installation of peripheral devices to the on-board connectors

4.8.1 AT Power Connection

Follow the instructions below to connect the WAFER-ULT5 to an AT power supply.



WARNING:

Disconnect the power supply power cord from its AC power source to prevent a sudden power surge to the WAFER-ULT5.

Step 1: **Locate the power cable.** The power cable is shown in the packing list in Chapter 2.

Step 2: **Connect the power cable to the motherboard.** Connect the 4-pin (2x2) Molex type power cable connector to the power connector on the motherboard. See Figure 4-13.

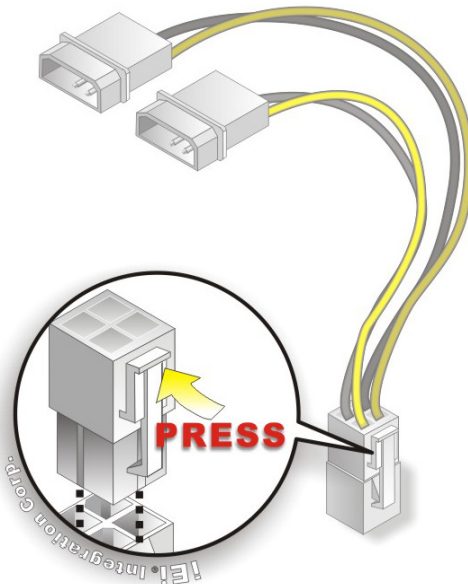

Figure 4-13: Power Cable to Motherboard Connection

WAFER-ULT5 SBC

Step 3: Connect power cable to power supply. Connect one of the 4-pin (1x4) Molex type power cable connectors to an AT power supply. See Figure 4-14.

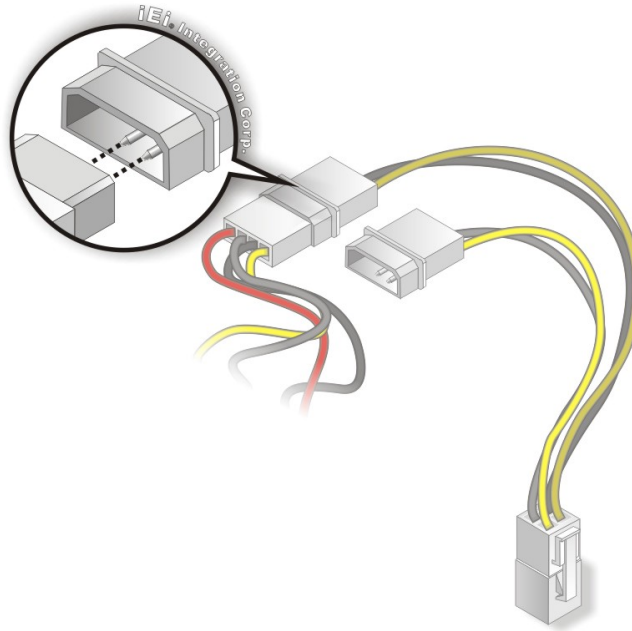

Figure 4-14: Connect Power Cable to Power Supply

4.8.2 7.1 Channel Audio Kit Installation



NOTE:

This item must be ordered separately, and connects to the audio connector. For further information please contact the nearest distributor, reseller or vendor or contact an IEI sales representative directly.

The audio kit attaches to the audio connector. The audio kit provides 7.1 channel audio. To install the audio kit, please refer to the steps below:

Step 1: Connect the cable to the audio kit. Connect the included cable to the audio kit. Make sure pin 1 aligns with the marked pin.

- Step 2:** Connect the cable to the board. Connect the other end of the cable to the board. Make sure to line up the marked pin 1.

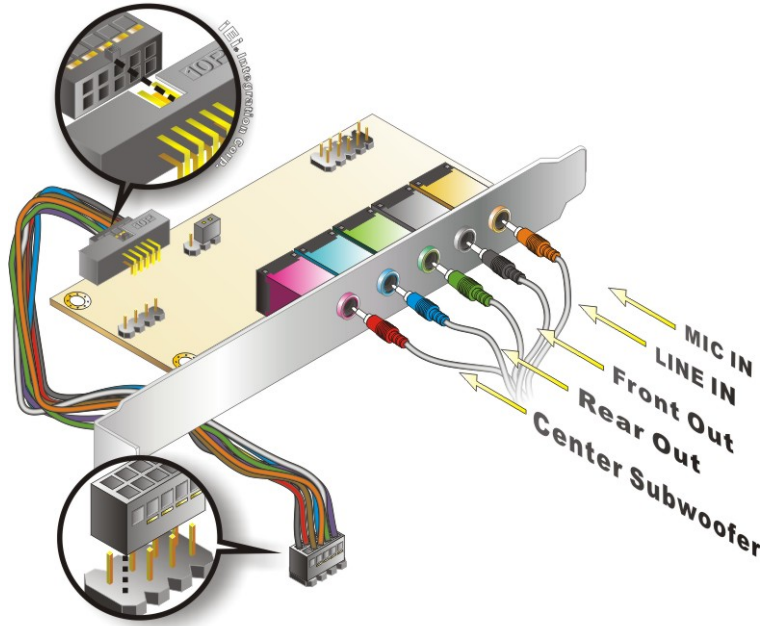

Figure 4-15: 7.1 Channel Audio Kit

- Step 3:** Mount the audio kit onto the chassis. Once the audio kit is connected to the board, secure the audio kit bracket to the system chassis.
- Step 4:** Connect the audio devices. Connect speakers and external audio sources to the audio jacks on the audio kit.
- Step 5:** Install the driver. Install the 7.1 channel audio driver included with the board.

4.8.3 RS-232 Cable Connection

The single RS-232 cable consists of one serial port connector attached to a serial communications cable that is then attached to a D-sub 9 male connector. To install the single RS-232 cable, please follow the steps below.

- Step 1:** Locate the connector. The location of the RS-232 connector is shown in Chapter 3.

WAFER-ULT5 SBC

Step 2: Insert the cable connector. Align the cable connector with the onboard connector. Make sure pin 1 on the board and connector line up. Pin 1 on the cable connector is indicated with a white dot. See **Figure 4-16**.

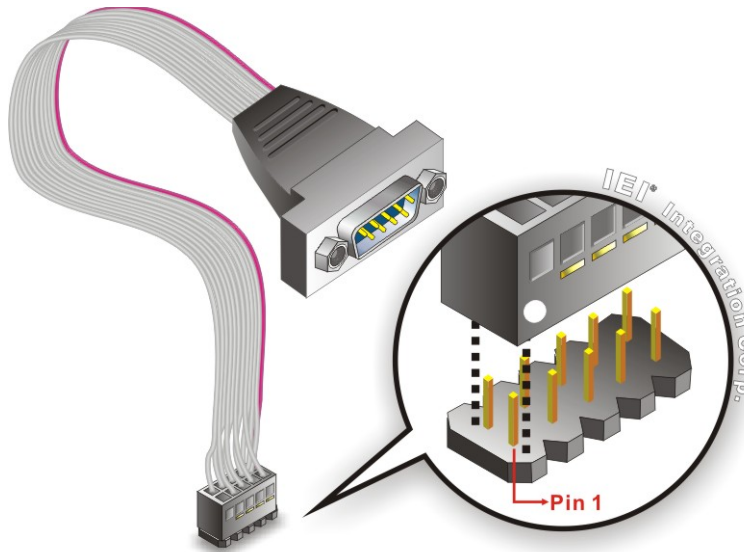

Figure 4-16: Single RS-232 Cable Installation

- Step 3: Secure the bracket.** The single RS-232 connector has two retention screws that must be secured to a chassis or bracket.
- Step 4: Connect the serial device.** Once the single RS-232 connector is connected to a chassis or bracket, a serial communications device can be connected to the system.

4.8.4 SATA Drive Connection

The WAFER-ULT5 is shipped with a SATA drive cable. To connect the SATA drive to the connector, please follow the steps below.

- Step 1: Locate the SATA connector and the SATA power connector.** The locations of the connectors are shown in **Chapter 3**.
- Step 2: Insert the cable connector.** Insert the cable connector into the on-board SATA drive connector and the SATA power connector. See **Figure 4-17**.

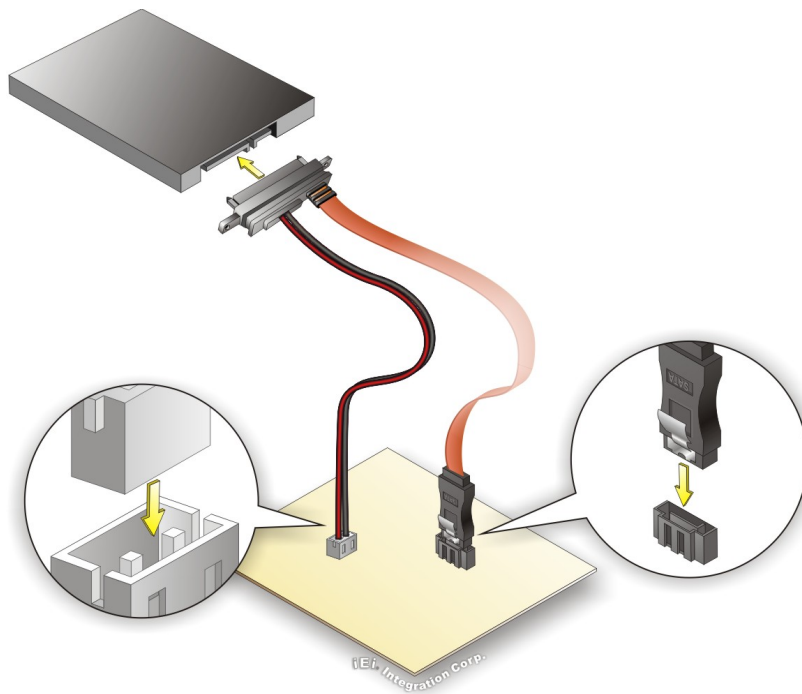

Figure 4-17: SATA Drive Cable Connection

- Step 3:** **Connect the cable to the SATA disk.** Connect the connector on the other end of the cable to the connector at the back of the SATA drive. See **Figure 4-17**.
- Step 4:** To remove the SATA cable from the SATA connector, press the clip on the connector at the end of the cable.

Chapter

5

BIOS

5.1 Introduction

The BIOS is programmed onto the BIOS chip. The BIOS setup program allows changes to certain system settings. This chapter outlines the options that can be changed.



NOTE:

Some of the BIOS options may vary throughout the life cycle of the product and are subject to change without prior notice.

5.1.1 Starting Setup

The UEFI BIOS is activated when the computer is turned on. The setup program can be activated in one of two ways.

1. Press the **DELETE** or **F2** key as soon as the system is turned on or
2. Press the **DELETE** or **F2** key when the “**Press Del to enter SETUP**” message appears on the screen.

If the message disappears before the **DELETE** or **F2** key is pressed, restart the computer and try again.

5.1.2 Using Setup

Use the arrow keys to highlight items, press **ENTER** to select, use the PageUp and PageDown keys to change entries, press **F1** for help and press **ESC** to quit. Navigation keys are shown in.

Key	Function
Up arrow	Move to previous item
Down arrow	Move to next item
Left arrow	Move to the item on the left hand side
Right arrow	Move to the item on the right hand side
+	Increase the numeric value or make changes

WAFER-ULT5 SBC

Key	Function
-	Decrease the numeric value or make changes
F1 key	General help, only for Status Page Setup Menu and Option Page Setup Menu
F2 key	Load previous values.
F3 key	Load optimized defaults
F4 key	Save changes and Exit BIOS
Esc key	Main Menu – Quit and not save changes into CMOS Status Page Setup Menu and Option Page Setup Menu -- Exit current page and return to Main Menu

5.1.3 Getting Help

When **F1** is pressed a small help window describing the appropriate keys to use and the possible selections for the highlighted item appears. To exit the Help Window press **Esc** or the **F1** key again.

5.1.4 Unable to Reboot after Configuration Changes

If the computer cannot boot after changes to the system configuration is made, CMOS defaults. Use the jumper described in **Section 4.6.2**.

5.1.5 BIOS Menu Bar

The **menu bar** on top of the BIOS screen has the following main items:

- Main – Changes the basic system configuration.
- Advanced – Changes the advanced system settings.
- Chipset – Changes the chipset settings.
- Security – Sets User and Supervisor Passwords.
- Boot – Changes the system boot configuration.
- Save & Exit – Selects exit options and loads default settings

The following sections completely describe the configuration options found in the menu items at the top of the BIOS screen and listed above.

5.2 Main

The **Main** BIOS menu (**BIOS Menu 1**) appears when the **BIOS Setup** program is entered.

```

Aptio Setup Utility - Copyright (C) 2019 American Megatrends, Inc.
  Main  Advanced  Chipset  Security  Boot  Save & Exit
BIOS Information
BIOS Vendor                American Megatrends
Core Version                5.13
Compliance                 EFI 2.7; PI 1.6
Project Version             B572AR12.ROM
Build Date and Time         12/18/2019 11:36:06

iWDD Vendor                 iEi
iWDD Version                B572ER11.bin

Processor Information
Name                       WhiskeyLake ULT
Type                       Intel(R) Core(TM)
                           i7-8665UE CPU@ 1.70GHz
Speed                      2000 MHz
ID                          0x806EC
Stepping                   V0
Number of Processors        4Core(s) / 8Thread(s)
Microcode Revision          CA
GT Info                     GT2 (0x3EA0)

IGFX VBIOS Version          1017
Memory RC Version           0.7.1.95
Total Memory                8192 MB
Memory Frequency            2133 MHz

PCH Information
Name                       CNL PCH-LP
PCH SKU                     (U) Premium SKU
Stepping                    D0

ME FW Version               12.0.47.1524
ME Firmware SKU             Corporate SKU

Access Level                Administrator

System Date                 [Fri 01/01/2010]
System Time                 [00:18:35]

-----
<->: Select Screen
^ v: Select Item
Enter: Select
+/-: Change Opt.
F1  General Help
F2  Previous Values
F3  Optimized Defaults
F4  Save
ESC  Exit

Version 2.20.1271. Copyright (C) 2019 American Megatrends, Inc.
  
```

BIOS Menu 1: Main

The System Overview field also has two user configurable fields:

WAFER-ULT5 SBC

→ System Date [xx/xx/xx]

Use the **System Date** option to set the system date. Manually enter the day, month and year.

→ System Time [xx:xx:xx]

Use the **System Time** option to set the system time. Manually enter the hours, minutes and seconds.

5.3 Advanced

Use the **Advanced** menu (**BIOS Menu 2**) to configure the CPU and peripheral devices through the following sub-menus:



WARNING!

Setting the wrong values in the sections below may cause the system to malfunction. Make sure that the settings made are compatible with the hardware.

```

Aptio Setup Utility - Copyright (C) 2019 American Megatrends, Inc.
Main  Advanced  Chipset  Security  Boot  Save & Exit
-----
> CPU Configuration
> PCH-FW Configuration
> ACPI Settings
> RTC Wake Settings
> iWDD H/W Monitor
> F81866 Super IO Configuration
> Serial Port Console Redirection
> USB Configuration
> NVMe Configuration
> iEi Feature

System ACPI Parameters.
-----
<=>: Select Screen
↑ ↓: Select Item
Enter>Select
F1  General Help
F2  Previous Values
F3  Optimized Defaults
F4  Save
ESC Exit

Version 2.20.1271. Copyright (C) 2019 American Megatrends, Inc.
    
```

BIOS Menu 2: Advanced

5.3.1 CPU Configuration

Use the **CPU Configuration** menu (**BIOS Menu 3**) to view detailed CPU specifications and configure the CPU.

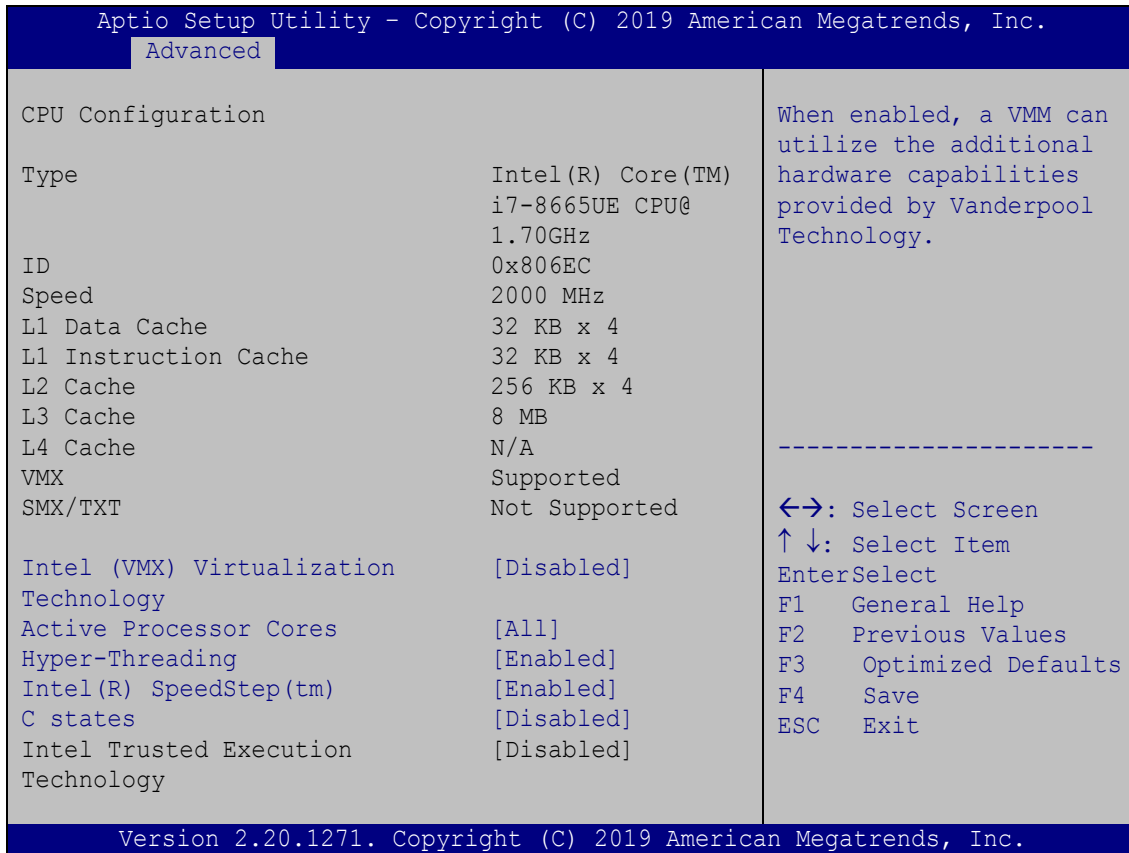

BIOS Menu 3: CPU Configuration

→ Intel® (VMX) Virtualization Technology [Disabled]

Use the **Intel® (VMX) Virtualization Technology** option to enable or disable virtualization on the system. When combined with third party software, Intel® Virtualization technology allows several OSs to run on the same system at the same time.

- **Disabled** **DEFAULT** Disables Intel® Virtualization Technology.
- **Enabled** Enables Intel® Virtualization Technology.

WAFER-ULT5 SBC

→ Active Processor Cores [All]

Use the **Active Processor Cores** BIOS option to enable numbers of cores in the processor package.

- **All** **DEFAULT** Enable all cores in the processor package.
- **1** Enable one core in the processor package.
- **2** Enable two cores in the processor package.
- **3** Enable three cores in the processor package.

→ Hyper-threading [Enabled]

Use the **Hyper-threading** BIOS option to enable or disable the Intel Hyper-Threading Technology.

- **Disabled** Disables the Intel Hyper-Threading Technology.
- **Enabled** **DEFAULT** Enables the Intel Hyper-Threading Technology.

→ Intel® SpeedStep™ [Enabled]

Use the **Intel® SpeedStep™** option to enable or disable the Intel® SpeedStep Technology.

- **Disabled** Disables the Intel® SpeedStep Technology.
- **Enabled** **DEFAULT** Enables the Intel® SpeedStep Technology.

→ C State [Disabled]

Use the **C State** option to enable or disable CPU C state.

- **Disabled** **DEFAULT** Disables CPU C state.
- **Enabled** Enables CPU C state.

5.3.2 PCH-FW Configuration

The **PCH-FW Configuration** menu (**BIOS Menu 4**) allows Intel® Active Management Technology (AMT) options to be configured.

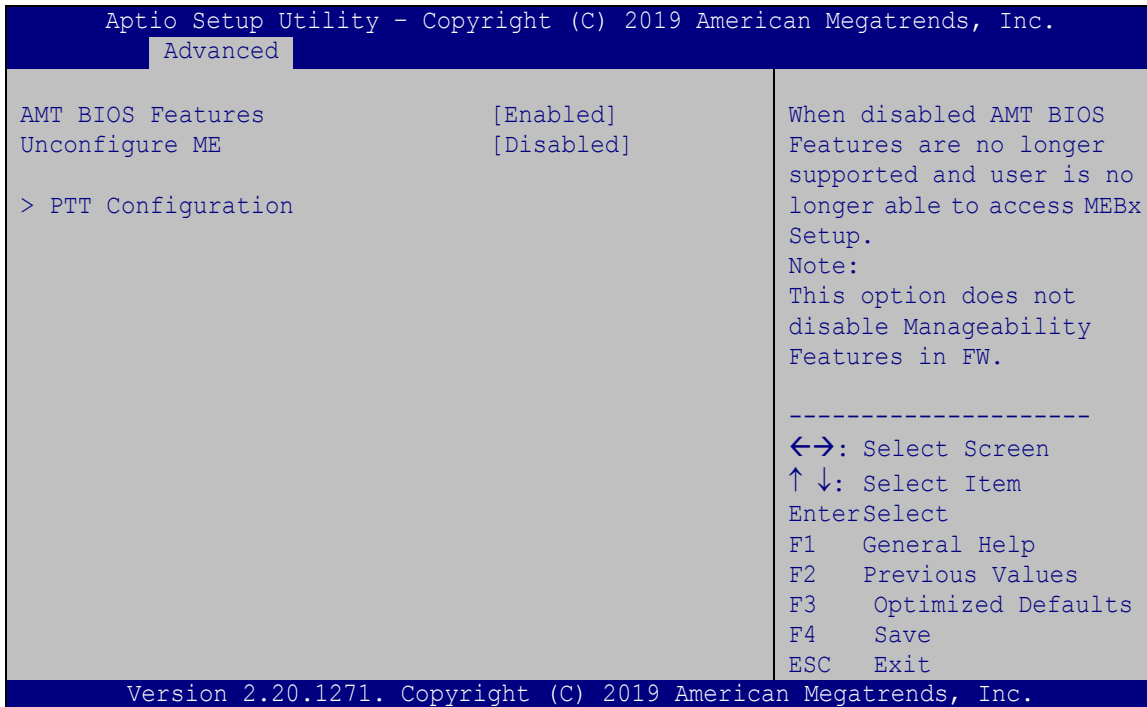

BIOS Menu 4: PCH-FW Configuration

➔ AMT BIOS Features [Enabled]

Use **AMT BIOS Features** option to enable or disable the Intel® AMT function.

- ➔ **Disabled** Intel® AMT is disabled
- ➔ **Enabled** **DEFAULT** Intel® AMT is enabled

➔ Unconfigure ME [Disabled]

Use the **Unconfigure ME** option to perform ME unconfigure without password operation.

- ➔ **Disabled** **DEFAULT** Not perform ME unconfigure
- ➔ **Enabled** To perform ME unconfigure

WAFER-ULT5 SBC

5.3.2.1 PTT Configuration

Use the **PTT Configuration** menu (**BIOS Menu 5**) to configure settings related to the Trusted Platform Module (TPM).

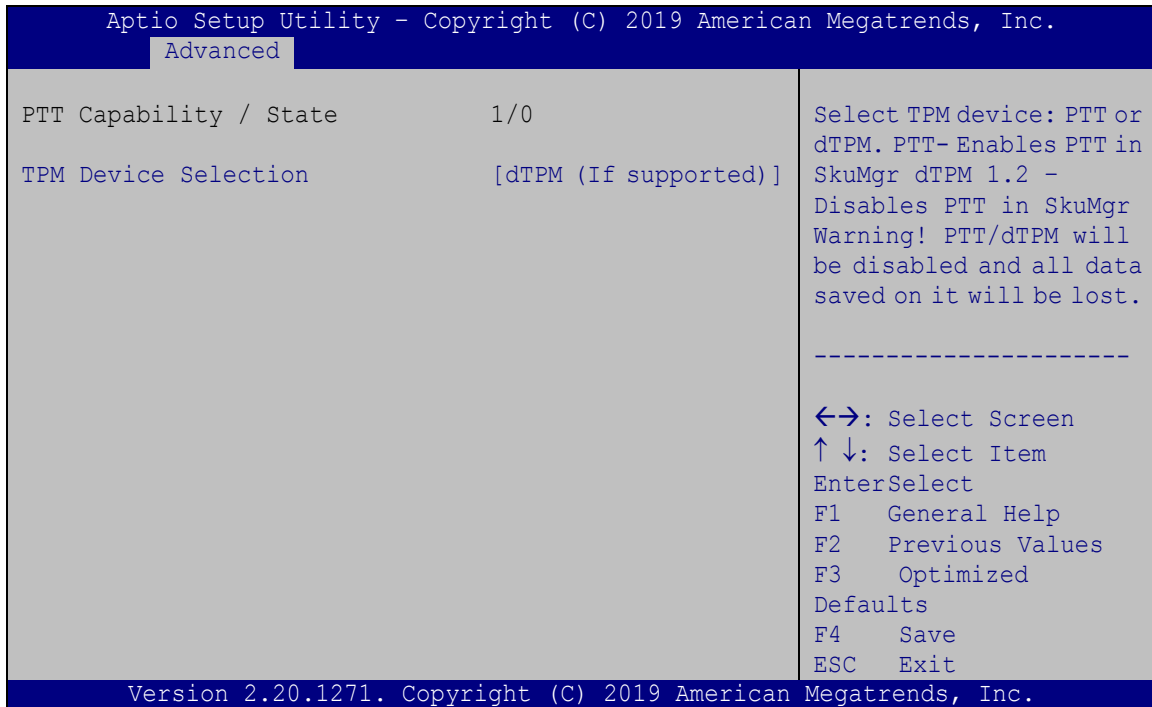

BIOS Menu 5: PTT Configuration

→ TPM Device Selection [dTPM (If supported)]

Use the **TPM Device Selection** option to configure support for the TPM.

- **dTPM** (If **DEFAULT** Disable PTT in SkuMgr.
supported)
- **PTT** Enable PTT in SkuMgr

5.3.3 ACPI Settings

The **ACPI Settings** menu (**BIOS Menu 6**) configures the Advanced Configuration and Power Interface (ACPI) options.

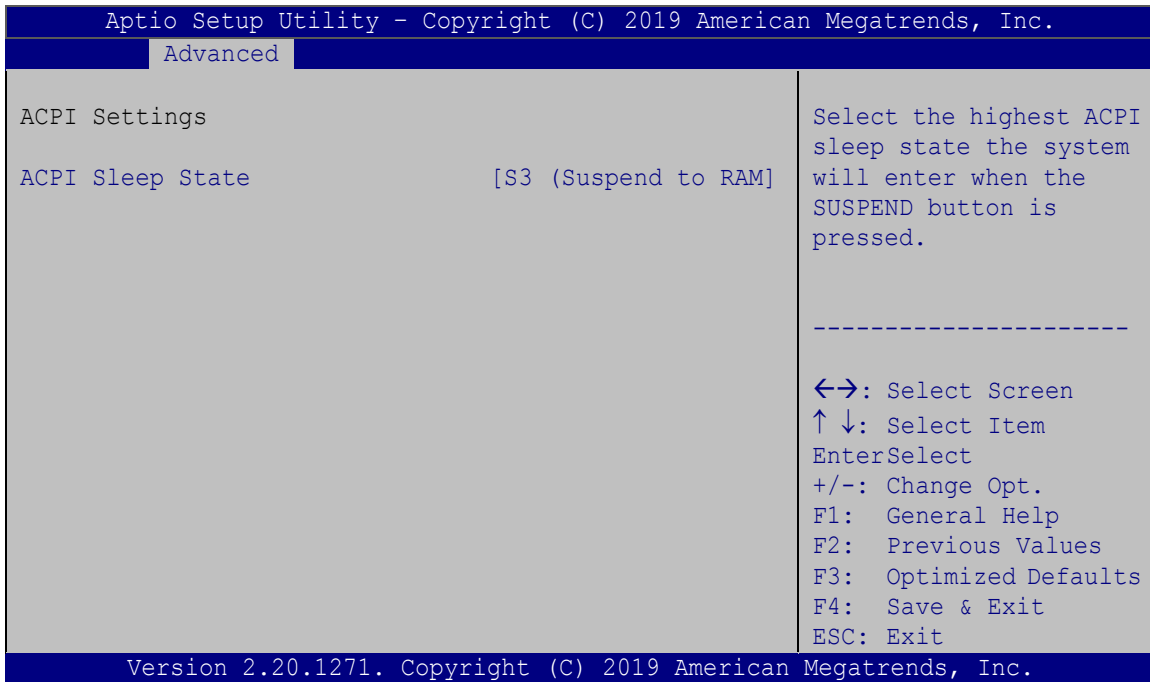

BIOS Menu 6: ACPI Settings

→ **ACPI Sleep State [S3 (Suspend to RAM)]**

Use the **ACPI Sleep State** option to specify the sleep state the system enters when it is not being used.

- **S3 (Suspend to DEFAULT RAM)** The caches are flushed and the CPU is powered off. Power to the RAM is maintained. The computer returns slower to a working state, but more power is saved.

WAFER-ULT5 SBC

5.3.4 RTC Wake Settings

The **RTC Wake Settings** menu (**BIOS Menu 7**) configures RTC wake event.

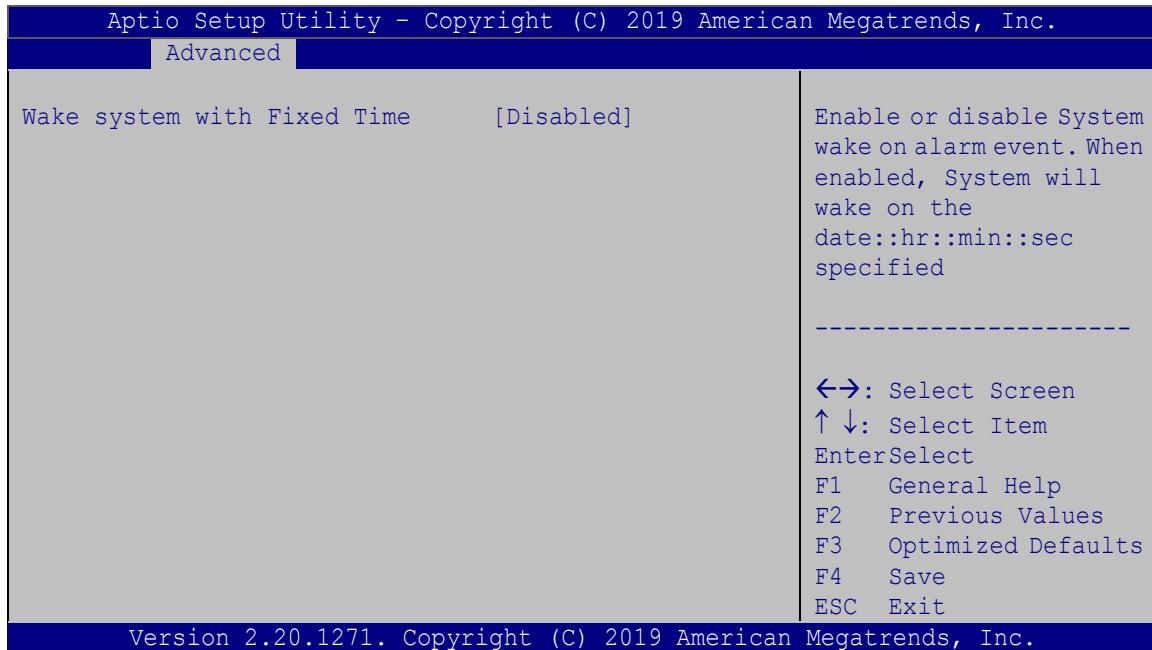

BIOS Menu 7: RTC Wake Settings

→ Wake system with Fixed Time [Disabled]

Use the **Wake system with Fixed Time** option to enable or disable the system wake on alarm event.

- **Disabled** **DEFAULT** The real time clock (RTC) cannot generate a wake event
- **Enabled** If selected, the **Wake up every day** option appears allowing you to enable to disable the system to wake every day at the specified time. Besides, the following options appear with values that can be selected:

Wake up date

Wake up hour

Wake up minute

Wake up second

After setting the alarm, the computer turns itself on from a suspend state when the alarm goes off.

5.3.5 iWDD H/W Monitor

The **iWDD H/W Monitor** menu (**BIOS Menu 8**) contains the fan configuration submenus and displays operating temperature, fan speeds and system voltages.

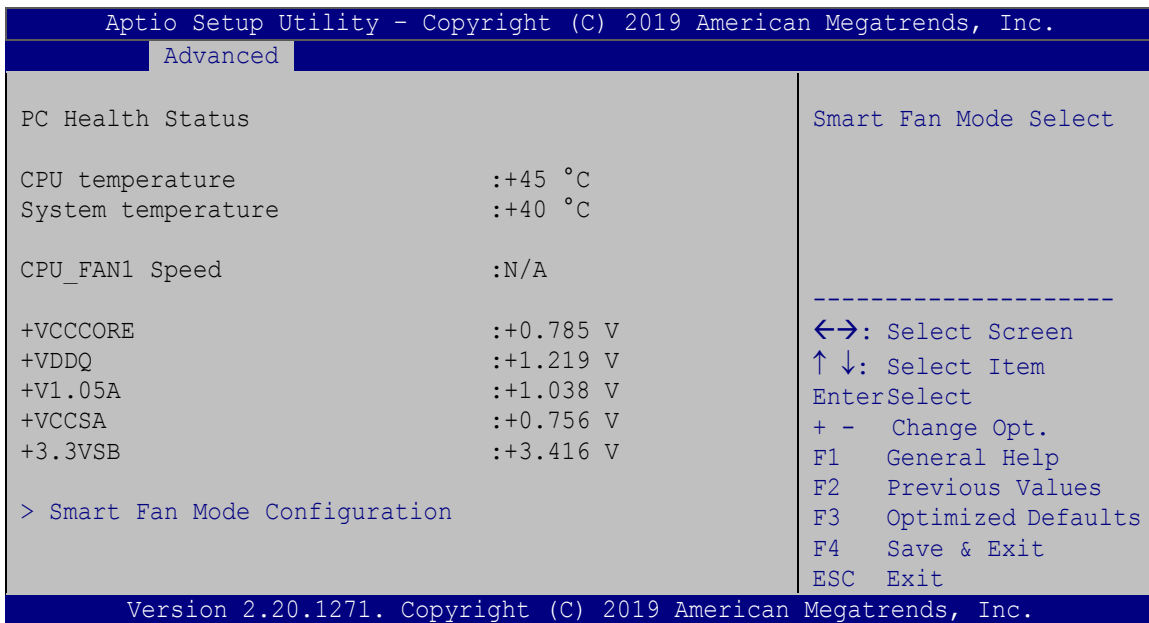

BIOS Menu 8: iWDD H/W Monitor

→ PC Health Status

The following system parameters and values are shown. The system parameters that are monitored are:

- System Temperatures:
 - CPU Temperature
 - System temperature
- Fan Speed:
 - CPU Fan Speed
- Voltages
 - +VCCCORE

WAFER-ULT5 SBC

- +VDDQ
- +V1.05A
- +VCCSA
- +3.3VSB

5.3.5.1 Smart Fan Mode Configuration

Use the **Smart Fan Mode Configuration** submenu (**BIOS Menu 9**) to configure fan temperature and speed settings.

```

Aptio Setup Utility - Copyright (C) 2019 American Megatrends, Inc.
Advanced
Smart Fan Mode Configuration
CPU_FAN1 Smart Fan Control      [Auto Mode]
Auto mode fan start temperature 40
Auto mode fan off temperature   30
Auto mode fan start PWM         30
Auto mode fan slope PWM         2
Smart Fan Mode Select
-----
<=>: Select Screen
↑ ↓: Select Item
EnterSelect
+ - Change Opt.
F1  General Help
F2  Previous Values
F3  Optimized Defaults
F4  Save & Exit
ESC Exit
Version 2.20.1271. Copyright (C) 2019 American Megatrends, Inc.
    
```

BIOS Menu 9: Smart Fan Mode Configuration

→ CPU_FAN1 Smart Fan Control [Auto Mode]

Use the **CPU_FAN1 Smart Fan Control** BIOS option to configure the CPU Smart Fan.

- **Manual Mode** The fan spins at the speed set in the Manual Mode option
- **Auto Mode** **DEFAULT** The fan adjusts its speed using these settings:
 - Auto mode fan start temperature
 - Auto mode fan off temperature
 - Auto mode fan start PWM
 - Auto mode fan slope PWM

→ **Auto mode fan start temperature [40]**



WARNING:

Setting this value too high may cause the fan to rotate at full speed only when the CPU is at a very high temperature and therefore cause the system to be damaged.

The **Auto mode fan start temperature** option can only be set if the **CPU_FAN1 Smart Fan Control** option is set to **Auto Mode**. If the system temperature is between **Start Temperature** and **Off Temperature**, the fan speed change to be **Start PWM**. To set a value, select the **Auto mode fan start temperature** option and enter a decimal number between 1 and 100.

→ **Auto mode fan off temperature [30]**



WARNING:

Setting this value too high may cause the fan to speed up only when the CPU is at a very high temperature and therefore cause the system to be damaged.

The **Auto mode fan off temperature** option can only be set if the **CPU_FAN1 Smart Fan control** option is set to **Auto Mode**. If the system temperature is lower than **Auto mode fan off temperature**, the fan speed change to be lowest. To set a value, select the **Auto mode fan off temperature** option and enter a decimal number between 1 and 100.

→ **Auto mode fan start PWM [30]**

The **Auto mode fan start PWM** option can only be set if the **CPU_FAN1 Smart Fan control** option is set to **Auto Mode**. Use the **Auto mode fan start PWM** option to set the PWM start value. To set a value, select the **Auto mode fan start PWM** option and enter a decimal number between 1 and 100.

WAFER-ULT5 SBC

→ Auto mode fan slope PWM [2]

The **Auto mode fan slope PWM** option can only be set if the **CPU_FAN1 Smart Fan control** option is set to **Auto Mode**. Use the **Auto mode fan slope PWM** option to select the linear rate at which the PWM mode increases with respect to an increase in temperature. To set a value, select the **Auto mode fan slope PWM** option and enter a decimal number between 1 and 8.

5.3.6 F81866 Super IO Configuration

Use the **F81866 Super IO Configuration** menu (**BIOS Menu 10**) to set or change the configurations for the serial ports.

```

Aptio Setup Utility - Copyright (C) 2019 American Megatrends, Inc.
  Advanced
F81866 Super IO Configuration
Super IO Chip                F81866
> Serial Port 1 Configuration
> Serial Port 2 Configuration

Set Parameters of Serial
Port 1 (COMA)
-----
←→: Select Screen
↑↓: Select Item
Enter>Select
F1  General Help
F2  Previous Values
F3  Optimized
Defaults
F4  Save
ESC Exit

Version 2.20.1271. Copyright (C) 2019 American Megatrends, Inc.

```

BIOS Menu 10: F81866 Super IO Configuration

5.3.6.1 Serial Port n Configuration

Use the **Serial Port n Configuration** menu (**BIOS Menu 11**) to configure the serial port n.

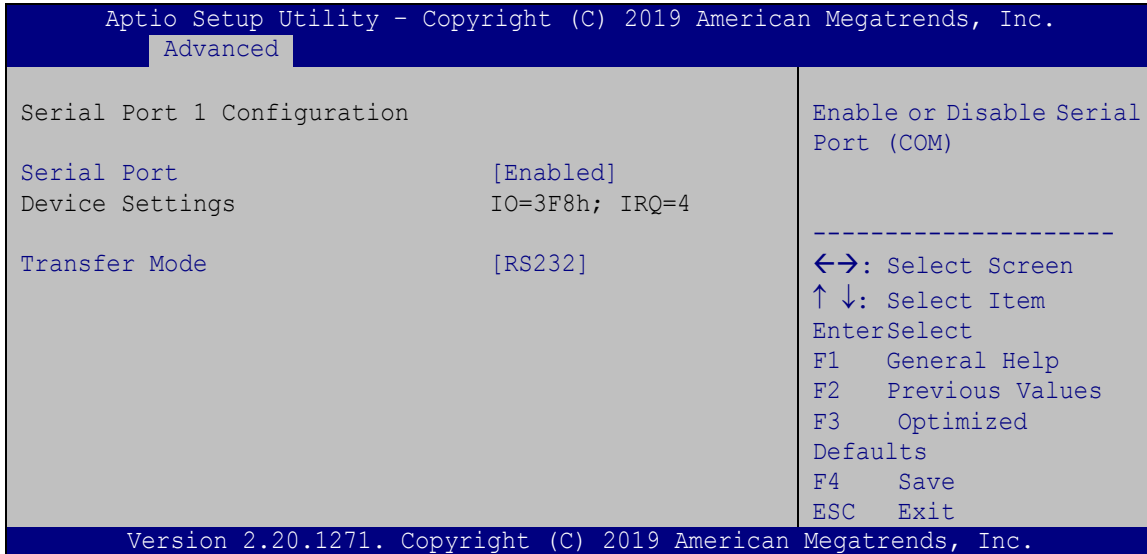

BIOS Menu 11: Serial Port n Configuration

→ Serial Port [Enabled]

Use the **Serial Port** option to enable or disable the serial port.

- **Disabled** Disable the serial port
- **Enabled** **DEFAULT** Enable the serial port

→ Transfer Mode [RS232]

Use the **Transfer Mode** option to configure the serial port.

- **RS422** Configure the serial port as RS-422 mode
- **RS232** **DEFAULT** Configure the serial port as RS-232 mode
- **RS485** Configure the serial port as RS-485 mode

WAFER-ULT5 SBC

5.3.7 Serial Port Console Redirection

The **Serial Port Console Redirection** menu (**BIOS Menu 12**) allows the console redirection options to be configured. Console redirection allows users to maintain a system remotely by re-directing keyboard input and text output through the serial port.

```

Aptio Setup Utility - Copyright (C) 2019 American Megatrends, Inc.
  Advanced
COM1
  Console Redirection          [Disabled]
> Console Redirection Settings
  Console Redirection          [Disabled]
> Console Redirection Settings
iAMT SOL
COM3(Pci Bus0, Dev22, Func3)
  Console Redirection          [Disabled]
> Console Redirection Settings
Legacy Console Redirection
> Legacy Console Redirection Settings

-----
<=>: Select Screen
↑ ↓: Select Item
Enter>Select
F1   General Help
F2   Previous Values
F3   Optimized
Defaults
F4   Save
ESC  Exit
Version 2.20.1271. Copyright (C) 2019 American Megatrends, Inc.
  
```

BIOS Menu 12: Serial Port Console Redirection

➔ Console Redirection [Disabled]

Use **Console Redirection** option to enable or disable the console redirection function.

- ➔ **Disabled** **DEFAULT** Disabled the console redirection function
- ➔ **Enabled** Enabled the console redirection function

5.3.7.1 Legacy Console Redirection Settings

The **Legacy Console Redirection Settings** menu (**BIOS Menu 13**) allows the legacy console redirection options to be configured.

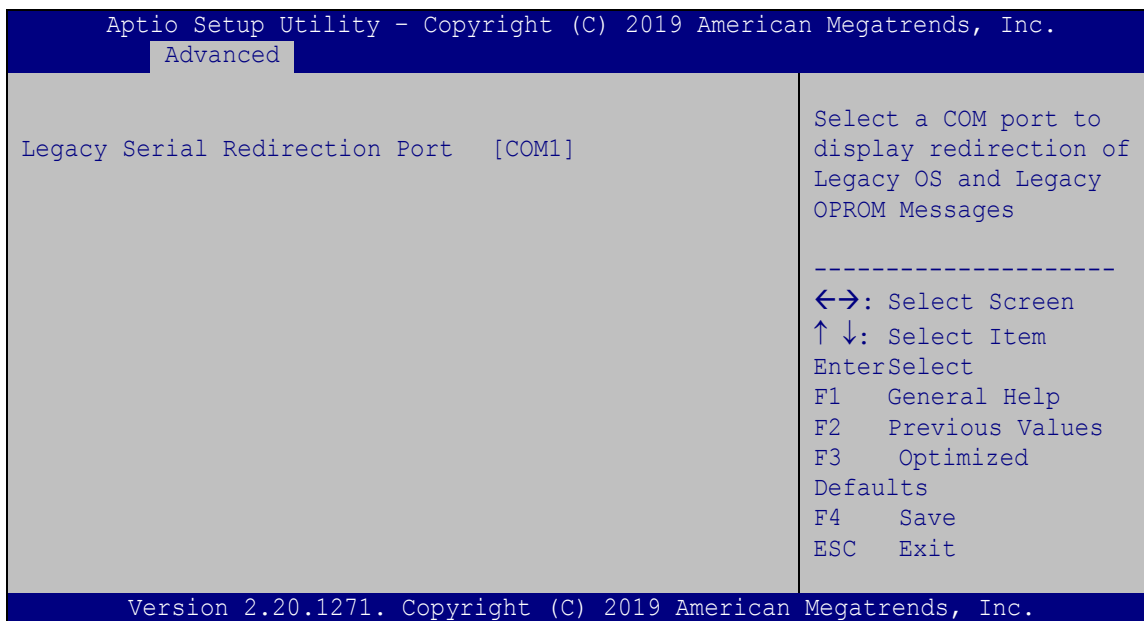

BIOS Menu 13: Legacy Console Redirection Settings

→ Legacy Serial Redirection Port [COM1]

Use the **Legacy Serial Redirection Port** option to specify a COM port to display redirection of legacy OS and legacy OPROM messages. The options include:

- COM1 **DEFAULT**
- COM2
- COM3 (Pci Bus0, Dev22, Func3)

→ Bits per second [115200]

Use the **Bits per second** option to specify the serial port transmission speed. The speed must match the other side. Long or noisy lines may require lower speeds.

- 9600** Sets the serial port transmission speed at 9600.
- 19200** Sets the serial port transmission speed at 19200.
- 57600** Sets the serial port transmission speed at 57600.
- 115200** **DEFAULT** Sets the serial port transmission speed at 115200.

→ Data Bits [8]

Use the **Data Bits** option to specify the number of data bits.

- 7** Sets the data bits at 7.
- 8** **DEFAULT** Sets the data bits at 8.

→ Parity [None]

Use the **Parity** option to specify the parity bit that can be sent with the data bits for detecting the transmission errors.

- None** **DEFAULT** No parity bit is sent with the data bits.
- Even** The parity bit is 0 if the number of ones in the data bits is even.
- Odd** The parity bit is 0 if the number of ones in the data bits is odd.
- Mark** The parity bit is always 1. This option does not provide error detection.
- Space** The parity bit is always 0. This option does not provide error detection.

WAFER-ULT5 SBC

→ Stop Bits [1]

Use the **Stop Bits** option to specify the number of stop bits used to indicate the end of a serial data packet. Communication with slow devices may require more than 1 stop bit.

- 1 **DEFAULT** Sets the number of stop bits at 1.
- 2 Sets the number of stop bits at 2.

5.3.8 USB Configuration

Use the **USB Configuration** menu (**BIOS Menu 15**) to read USB configuration information and configure the USB settings.

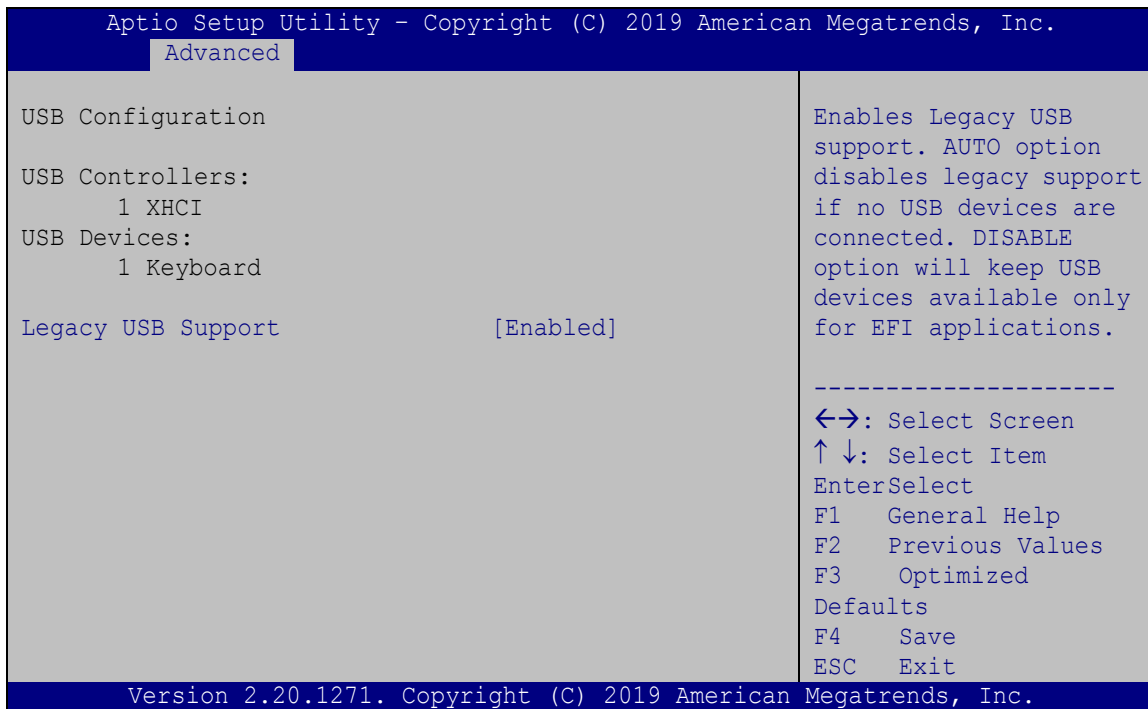

BIOS Menu 15: USB Configuration

→ USB Devices

The **USB Devices Enabled** field lists the USB devices that are enabled on the system

➔ **Legacy USB Support [Enabled]**

Use the **Legacy USB Support** BIOS option to enable USB mouse and USB keyboard support. Normally if this option is not enabled, any attached USB mouse or USB keyboard does not become available until a USB compatible operating system is fully booted with all USB drivers loaded. When this option is enabled, any attached USB mouse or USB keyboard can control the system even when there is no USB driver loaded onto the system.

- ➔ **Enabled** **DEFAULT** Legacy USB support enabled
- ➔ **Disabled** Legacy USB support disabled
- ➔ **Auto** Legacy USB support disabled if no USB devices are connected

5.3.9 NVMe Configuration

Use the **NVMe Configuration (BIOS Menu 16)** menu to display the NVMe controller and device information.

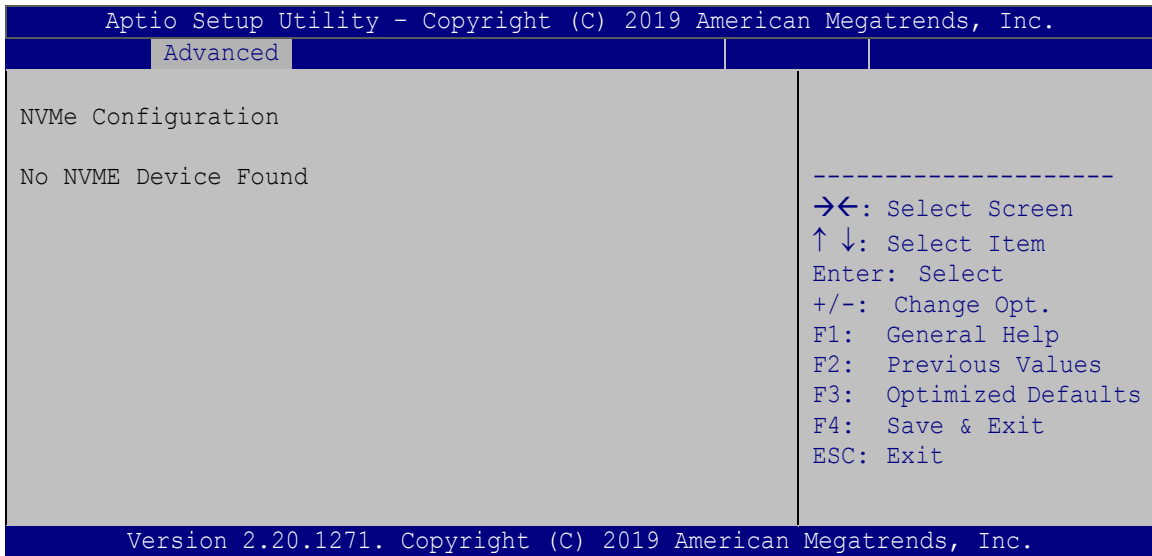

BIOS Menu 16: NVMe Configuration

WAFER-ULT5 SBC

5.3.10 IEI Feature

Use the **IEI Feature** menu (**BIOS Menu 17**) to configure One Key Recovery function.

```

Aptio Setup Utility - Copyright (C) 2019 American Megatrends, Inc.
-----
Advanced
-----
iEi Feature
Auto Recovery Function          [Disabled]
                                Auto Recovery Function
                                Reboot and recover
                                system automatically
                                within 10 min, when OS
                                crashes. Please install
                                Auto Recovery API
                                service before enabling
                                this function
                                -----
                                ←→: Select Screen
                                ↑↓: Select Item
                                Enter>Select
                                F1   General Help
                                F2   Previous Values
                                F3   Optimized Defaults
                                F4   Save
                                ESC  Exit
-----
Version 2.20.1271. Copyright (C) 2019 American Megatrends, Inc.

```

BIOS Menu 17: IEI Feature

→ Auto Recovery Function [Disabled]

Use the **Auto Recovery Function** BIOS option to enable or disable the auto recovery function of the IEI One Key Recovery.

- **Disabled** **DEFAULT** Auto recovery function disabled
- **Enabled** Auto recovery function enabled

5.4 Chipset

Use the **Chipset** menu (**BIOS Menu 18**) to configure the system chipset.

```

Aptio Setup Utility - Copyright (C) 2019 American Megatrends, Inc.
Main   Advanced  Chipset   Boot   Security  Save & Exit  Server Mgmt

> System Agent (SA) Configuration
> PCH-IO Configuration

System Agent (SA)
Parameters

-----
<-->: Select Screen
↑ ↓: Select Item
Enter>Select
+ -   Change Opt.
F1    General Help
F2    Previous Values
F3    Optimized Defaults
F4    Save & Exit
ESC   Exit

Version 2.20.1271. Copyright (C) 2019 American Megatrends, Inc.
    
```

BIOS Menu 18: Chipset

5.4.1 System Agent (SA) Configuration

Use the **System Agent (SA) Configuration** menu (**BIOS Menu 19**) to configure the System Agent (SA) parameters.

```

Aptio Setup Utility - Copyright (C) 2019 American Megatrends, Inc.
Chipset

System Agent (SA) Configuration
VT-d                               Supported

> Memory Configuration
> Graphics Configuration

VT-d                               [Disabled]

Memory Configuration
Parameters

-----
<-->: Select Screen
↑ ↓: Select Item
Enter>Select
+ -   Change Opt.
F1    General Help
F2    Previous Values
F3    Optimized Defaults
F4    Save & Exit
ESC   Exit

Version 2.20.1271. Copyright (C) 2019 American Megatrends, Inc.
    
```

BIOS Menu 19: System Agent (SA) Configuration

WAFER-ULT5 SBC

→ VT-d [Disabled]

Use the **VT-d** option to enable or disable VT-d support.

→ **Disabled** **DEFAULT** Disable VT-d support.

→ **Enabled** Enable VT-d support.

5.4.1.1 Memory Configuration

Use the **Memory Configuration** submenu (**BIOS Menu 20**) to display the memory information.

```

Aptio Setup Utility - Copyright (C) 2019 American Megatrends, Inc.
  Chipset
Memory Configuration
Memory Frequency          2133 MHz
DIMM1
  Size                    Populated & Enabled
                        8192 MB (DDR4)
-----
<->: Select Screen
↑ ↓: Select Item
EnterSelect
+ - Change Opt.
F1  General Help
F2  Previous Values
F3  Optimized Defaults
F4  Save & Exit
ESC Exit
Version 2.20.1271. Copyright (C) 2019 American Megatrends, Inc.
  
```

BIOS Menu 20: Memory Configuration

5.4.1.2 Graphics Configuration

Use the **Graphics Configuration** menu (**BIOS Menu 21**) to configure the graphics settings.

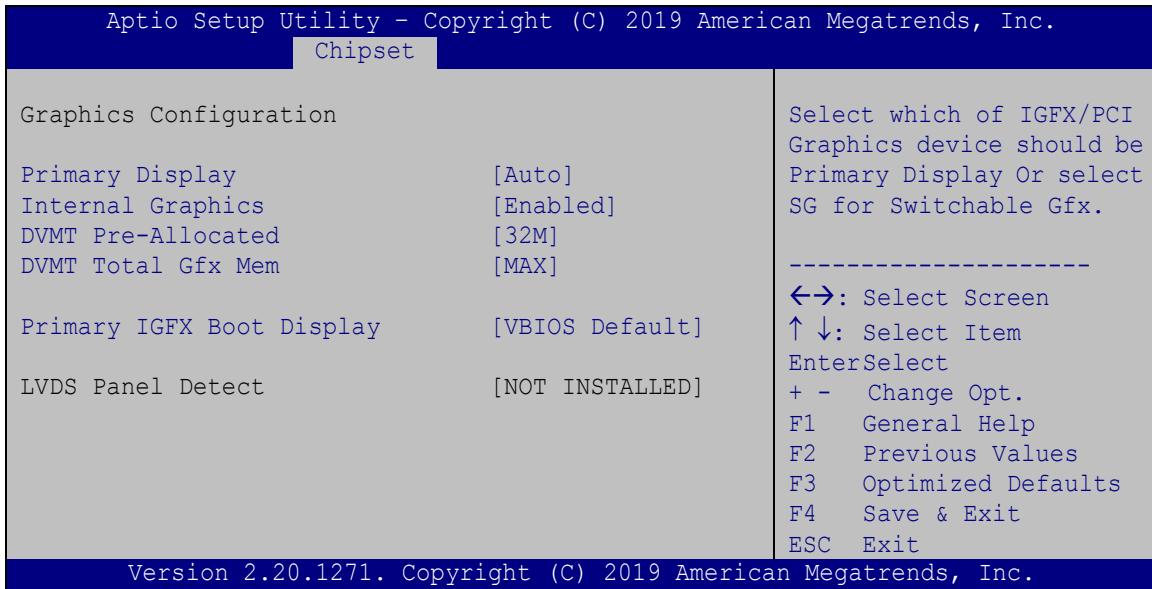

BIOS Menu 21: Graphics Configuration

→ Primary Display [Auto]

Use the **Primary Display** option to select the graphics controller used as the primary boot device. Configuration options are listed below:

- Auto **DEFAULT**
- IGFX
- PCI

→ Internal Graphics [Enabled]

Use the **Internal Graphics** option to enable or disable the internal graphics device.

- **Auto** The internal graphics device is automatically detected and enabled.
- **Disabled** Disable the internal graphics device.

WAFER-ULT5 SBC

- **Enabled** **DEFAULT** Enable the internal graphics device. The following options/submenu appear with values that can be selected:

DVMT Pre-Allocated

DVMT Total Gfx Mem

LCD Control

→ **DVMT Pre-Allocated [32M]**

Use the **DVMT Pre-Allocated** option to set the amount of system memory allocated to the integrated graphics processor when the system boots. The system memory allocated can then only be used as graphics memory, and is no longer available to applications or the operating system. Configuration options are listed below:

- 32M **DEFAULT**
- 64M

→ **DVMT Total Gfx Mem [MAX]**

Use the **DVMT Total Gfx Mem** option to select DVMT 5.0 total graphic memory size used by the internal graphics device. The following options are available:

- 128M
- 256M
- MAX **DEFAULT**

→ **Primary IGFX Boot Display [VBIOS Default]**

Use the **Primary IGFX Boot Display** option to select the display device used by the system when it boots.

- VBIOS Default **DEFAULT**
- HDMI1A
- HDMI1B
- LVDS1

5.4.2 PCH-IO Configuration

Use the **PCH-IO Configuration** menu (**BIOS Menu 22**) to configure the PCH-IO chipset.

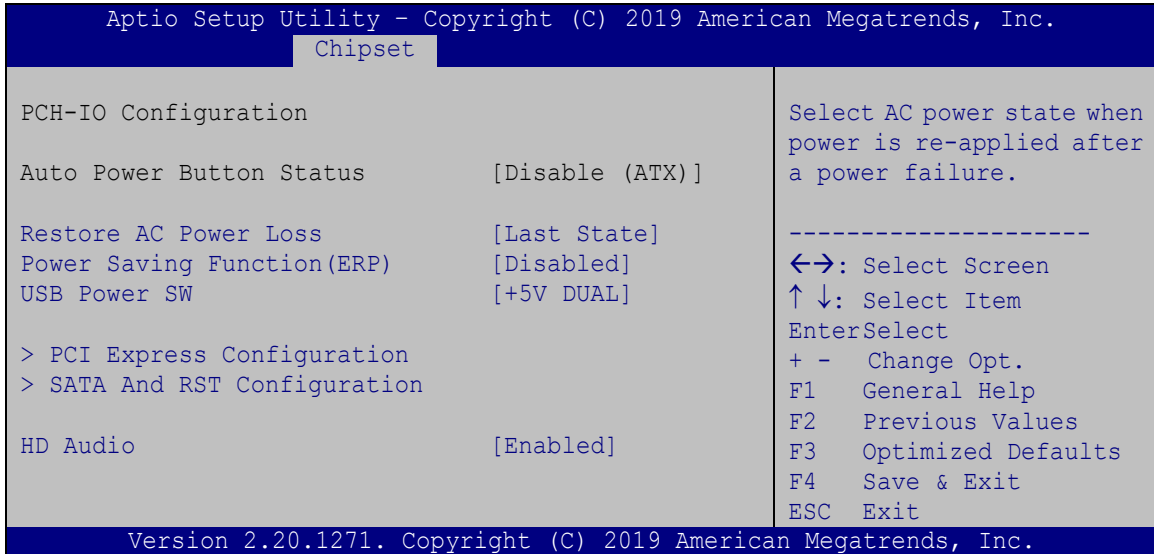

BIOS Menu 22: PCH-IO Configuration

➔ Restore AC Power Loss [Last State]

Use the **Restore AC Power** BIOS option to specify what state the system returns to if there is a sudden loss of power to the system.

- ➔ **Power Off** The system remains turned off
- ➔ **Power On** The system turns on
- ➔ **Last State DEFAULT** The system returns to its previous state. If it was on, it turns itself on. If it was off, it remains off.

WAFER-ULT5 SBC

→ Power Saving Function(ERP) [Disabled]

Use the **Power Saving Function(ERP)** BIOS option to enable or disable the power saving function.

- **Disabled** **DEFAULT** Power saving function is disabled.
- **Enabled** Power saving function is enabled. It will reduce power consumption when the system is off.

→ USB Power SW [+5V DUAL]

Use the **USB Power SW** BIOS option to configure whether to provide power to the USB connectors when the system is in S3/S4 sleep state. This option is valid only when the above **Power Saving Function (ERP)** BIOS option is disabled.

- **+5V** **DEFAULT** Power is provided to the USB connectors when the system is in S3/S4 sleep state
- **+5V** Power is not provided to the USB connectors when the system is in S3/S4 sleep state

→ HD Audio [Enabled]

Use the **HD Audio** BIOS option to enable or disable the High Definition Audio controller.

- **Disabled** The High Definition Audio controller is disabled.
- **Enabled** **DEFAULT** The High Definition Audio controller is enabled.

5.4.2.1 PCI Express Configuration

Use the **PCI Express Configuration** submenu (**BIOS Menu 23**) to configure the PCI Express slots.

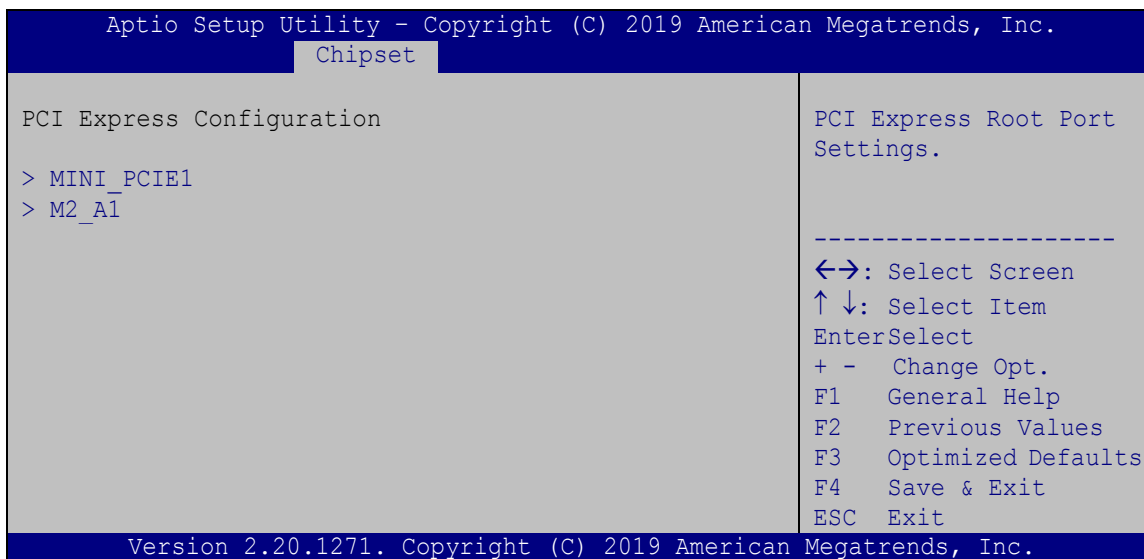

BIOS Menu 23: PCI Express Configuration

5.4.2.1.1 MINI_PCIE1 / M2_A1 Configuration

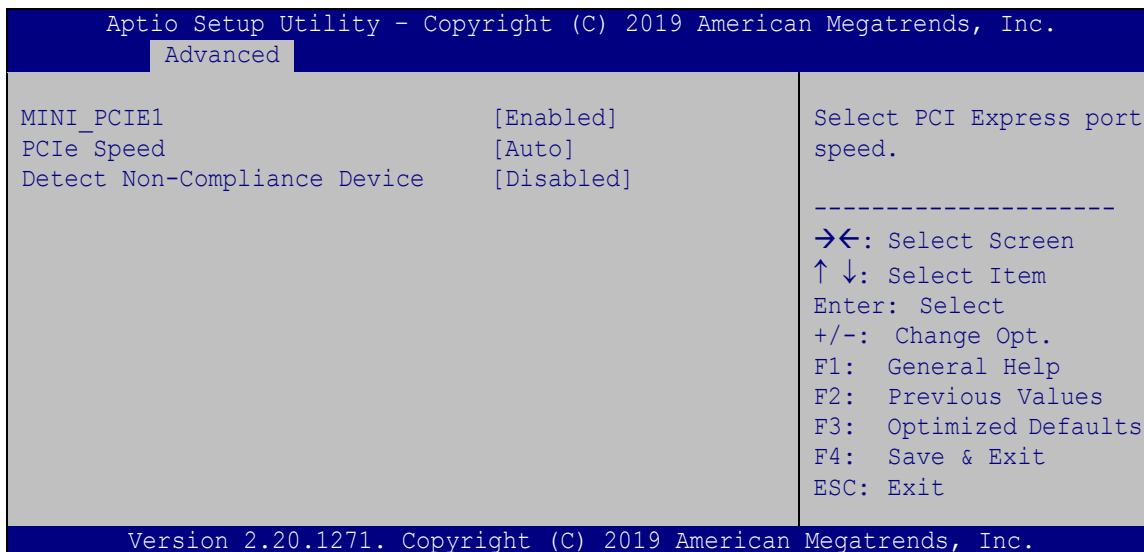

BIOS Menu 24: MINI_PCIE1 / M2_A1 Configuration

WAFER-ULT5 SBC

→ MINI_PCIE1 / M2_A1 [Enabled]

Use the **MINI_PCIE1 / M2_A1** option to enable or disable the PCIe Mini or M.2 expansion slot.

- **Disabled** Disables the expansion slot.
- **Enabled** **DEFAULT** Enables the expansion slot.

→ PCIe Speed [Auto]

Use this option to select the support type of the PCI Express slots. The following options are available:

- Auto **Default**
- Gen1
- Gen2
- Gen3

→ Detect Non-Compliance Device [Disabled]

Use the **Detect Non-Compliance Device** option to enable or disable detecting if a non-compliance PCI Express device is connected to the PCI Express slot.

- **Disabled** **DEFAULT** Disables to detect if a non-compliance PCI Express device is connected to the PCI Express slot.
- **Enabled** Enables to detect if a non-compliance PCI Express device is connected to the PCI Express slot.

5.4.2.2 SATA And RST Configuration

Use the **SATA And RST Configuration** menu (**BIOS Menu 25**) to change and/or set the configuration of the SATA devices installed in the system.

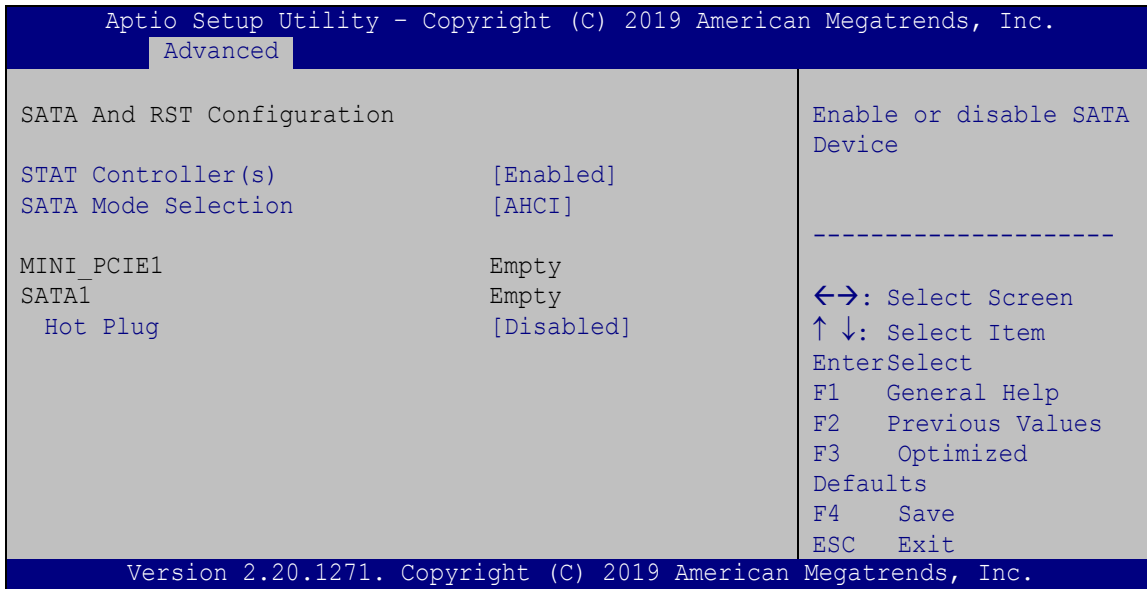

BIOS Menu 25: SATA and RST Configuration

→ STAT Controller(s) [Enabled]

Use the **STAT Controller(s)** option to enable or disable the SATA device.

- **Enabled** **DEFAULT** Enables the SATA device.
- **Disabled** Disables the SATA device.

→ SATA Mode Selection [AHCI]

Use the **SATA Mode Selection** option to configure how the SATA controller(s) operate.

- **AHCI** **DEFAULT** Configures SATA devices as AHCI device.
- **Intel RST Premium** Configures SATA devices as RAID device.

WAFER-ULT5 SBC

→ Hot Plug [Disabled]

Use the **Hot Plug** option to enable or disable the SATA device hot plug.

- **Disabled** **DEFAULT** Disables the SATA device hot plug.
- **Enabled** Enables the SATA device hot plug

5.5 Security

Use the **Security** menu (**BIOS Menu 26**) to set system and user passwords.

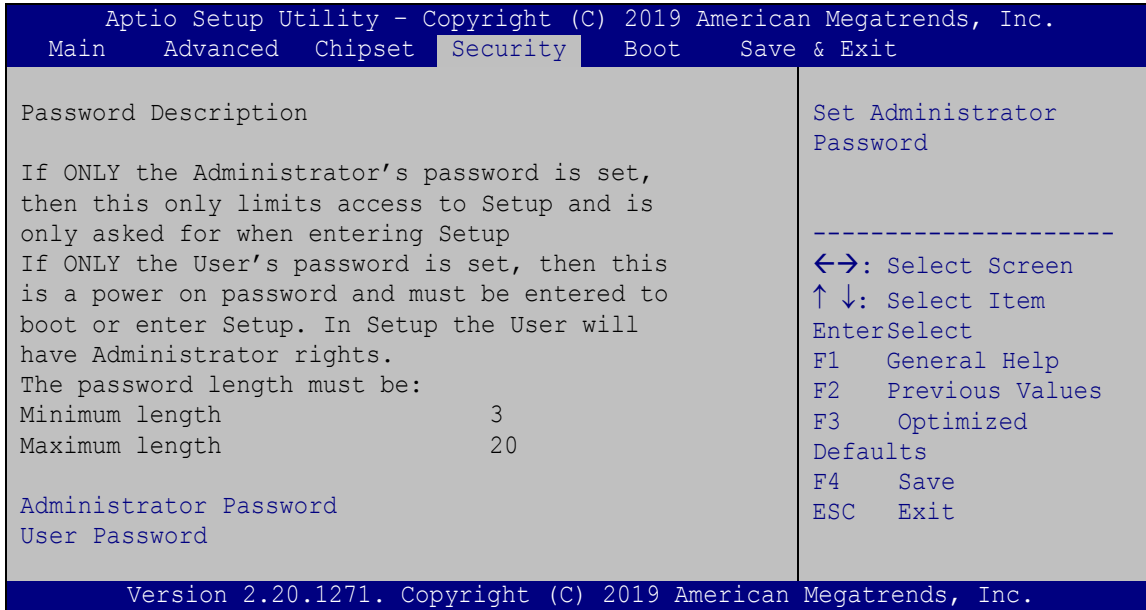

BIOS Menu 26: Security

→ Administrator Password

Use the **Administrator Password** to set or change a administrator password.

→ User Password

Use the **User Password** to set or change a user password.

WAFER-ULT5 SBC

5.6 Boot

Use the **Boot** menu (**BIOS Menu 27**) to configure system boot options.

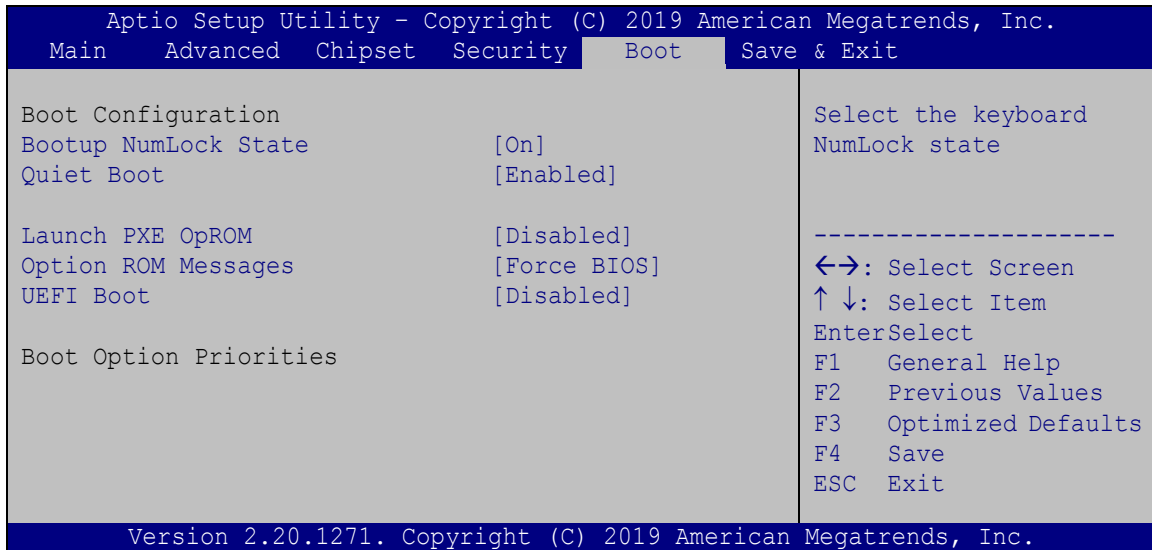

BIOS Menu 27: Boot

→ Bootup NumLock State [On]

Use the **Bootup NumLock State** BIOS option to specify if the number lock setting must be modified during boot up.

→ **On** **DEFAULT** Allows the Number Lock on the keyboard to be enabled automatically when the computer system boots up. This allows the immediate use of the 10-key numeric keypad located on the right side of the keyboard. To confirm this, the Number Lock LED light on the keyboard is lit.

→ **Off** Does not enable the keyboard Number Lock automatically. To use the 10-keys on the keyboard, press the Number Lock key located on the upper left-hand corner of the 10-key pad. The Number Lock LED on the keyboard lights up when the Number Lock is engaged.

→ Quiet Boot [Enabled]

Use the **Quiet Boot** BIOS option to select the screen display when the system boots.

- **Disabled** Normal POST messages displayed
- **Enabled** **DEFAULT** OEM Logo displayed instead of POST messages

→ Launch PXE OpROM [Disabled]

Use the **Launch PXE OpROM** option to enable or disable boot option for legacy network devices.

- **Disabled** **DEFAULT** Ignore all PXE Option ROMs
- **Enabled** Load PXE Option ROMs.

→ Option ROM Messages [Force BIOS]

Use the **Option ROM Messages** option to set the Option ROM display mode.

- **Force BIOS** **DEFAULT** Sets display mode to force BIOS.
- **Keep Current** Sets display mode to current.

→ UEFI Boot [Disabled]

Use the **UEFI Boot** option to enable or disable to boot from the UEFI devices.

- **Disabled** **DEFAULT** Boot from UEFI devices is disabled.
- **Enabled** Boot from UEFI devices is enabled.

→ Boot Option Priority

Use the **Boot Option Priority** function to set the system boot sequence from the available devices. The drive sequence also depends on the boot sequence in the individual device section.

WAFER-ULT5 SBC

5.7 Exit

Use the **Exit** menu (**BIOS Menu 28**) to load default BIOS values, optimal failsafe values and to save configuration changes.

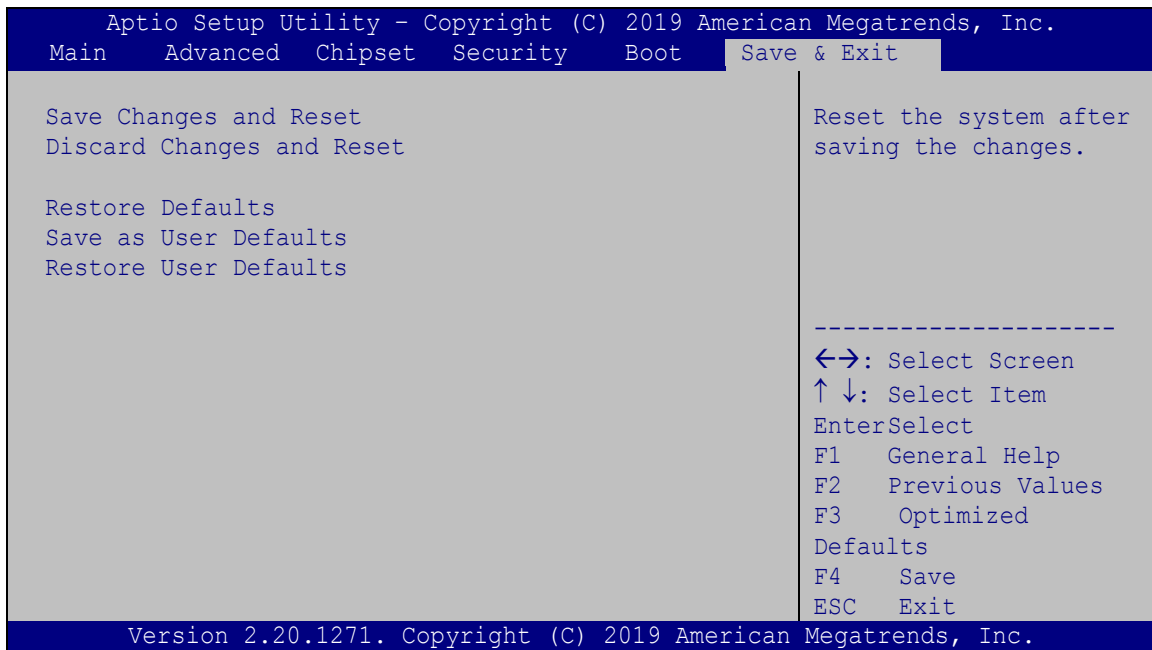

BIOS Menu 28: Exit

→ Save Changes and Reset

Use the **Save Changes and Reset** option to save the changes made to the BIOS options and to exit the BIOS configuration setup program.

→ Discard Changes and Reset

Use the **Discard Changes and Reset** option to exit the system without saving the changes made to the BIOS configuration setup program.

→ Restore Defaults

Use the **Restore Defaults** option to load the optimal default values for each of the parameters on the Setup menus. **F3 key can be used for this operation.**

→ **Save as User Defaults**

Use the **Save as User Defaults** option to save the changes done so far as user defaults.

→ **Restore User Defaults**

Use the **Restore User Defaults** option to restore the user defaults to all the setup options.

Chapter

6

Software Drivers

6.1 Available Drivers

All the drivers for the WAFER-ULT5 are available on IEI Resource Download Center (<https://download.ieiworld.com>). Type WAFER-ULT5 and press Enter to find all the relevant software, utilities, and documentation.

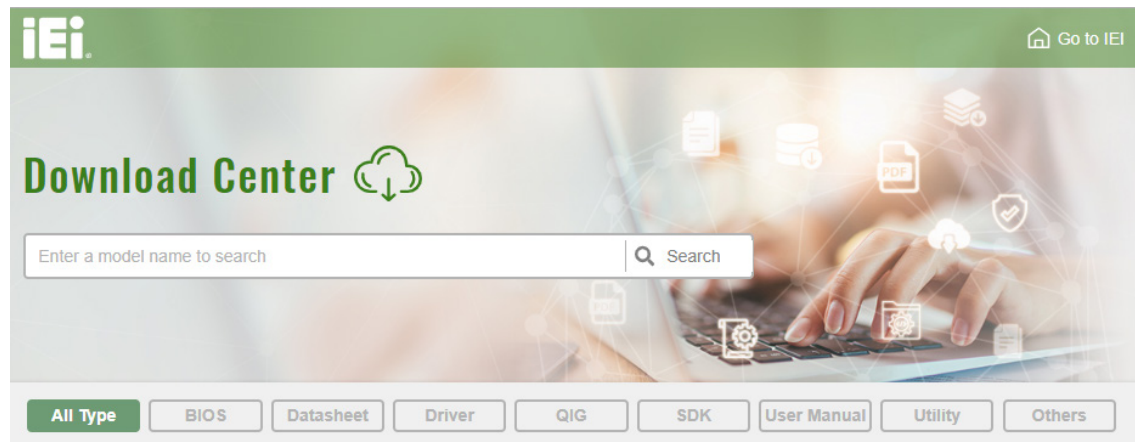
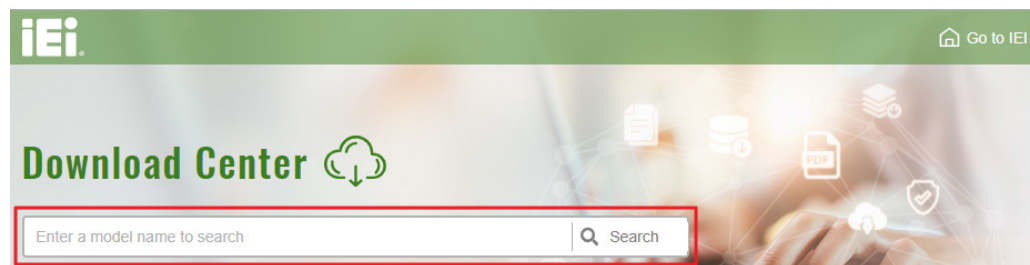

Figure 6-1: IEI Resource Download Center

6.2 Driver Download

To download drivers from IEI Resource Download Center, follow the steps below.

Step 1: Go to <https://download.ieiworld.com>. Type WAFER-ULT5 and press Enter.



Step 2: All product-related software, utilities, and documentation will be listed. You can choose **Driver** to filter the result.

WAFER-ULT5 SBC

[All Type](#)
[BIOS](#)
[Datasheet](#)
[Driver](#)
[QIG](#)
[SDK](#)
[User Manual](#)
[Utility](#)
[Others](#)

WAFER-BT-i1 [Product Info](#)

[Embedded Computer](#) ▶ [Single Board Computer](#) ▶ [Embedded Board](#)
 3.5" SBC with Intel® 22nm Atom™/Celeron® on-board SoC

Driver

File Name	Published	Version	File Checksum
7B000-001033-RS V2.3.iso (2.23 GB)	2017/10/03	2.30	3B2DB1F792779A93A8F50DDBC3943E30

Step 3: Click the driver file name on the page and you will be prompted with the following window. You can download the entire ISO file (❶), or click the small arrow to find an individual driver and click the file name to download (❷).

7B000-001168-RS_V1.4.iso

❶ [Click here to download entire ISO file. \(2.99 GB\)](#)

* Download individual file *

- Docs
 - 1.Chipset
 - 10.1.1.12.zip (2.7 MB)
 - 2.VGA
 - 3.Audio
 - 4.Lan
 - 5.USB 3.0
 - 6.Serial IO
 - 7.TXE
 - 8.Manual

❷



NOTE:

To install software from the downloaded ISO image file in Windows 8, 8.1 or 10, double-click the ISO file to mount it as a virtual drive to view its content. On Windows 7 system, an additional tool (such as Virtual CD-ROM Control Panel from Microsoft) is needed to mount the file.

**NOTE:**

The Intel TXE requires that Microsoft's "Kernel-Mode Driver Framework (KMDf) version 1.11 update for Windows 7" must be installed first on Windows 7 OS. If the KMDf is not installed, either error 37 or error 28 may appear on the Intel TXE device in Device Manager.

Please find the KMDf version 1.11 update for Windows 7 in the TXE driver folder in the driver CD or click the following link to download it.

<http://www.microsoft.com/en-us/download/details.aspx?id=38423>

Appendix

A

Regulatory Compliance

DECLARATION OF CONFORMITY

This equipment has been tested and found to comply with specifications for CE marking. If the user modifies and/or installs other devices in the equipment, the CE conformity declaration may no longer apply.

FCC WARNING

This equipment complies with Part 15 of the FCC Rules. Operation is subject to the following two conditions:

- This device may not cause harmful interference, and
- This device must accept any interference received, including interference that may cause undesired operation.

This equipment has been tested and found to comply with the limits for a Class A digital device, pursuant to part 15 of the FCC Rules. These limits are designed to provide reasonable protection against harmful interference when the equipment is operated in a commercial environment. This equipment generates, uses, and can radiate radio frequency energy and, if not installed and used in accordance with the instruction manual, may cause harmful interference to radio communications. Operation of this equipment in a residential area is likely to cause harmful interference in which case the user will be required to correct the interference at his own expense.

Appendix

B

Product Disposal

**CAUTION:**

Risk of explosion if battery is replaced by an incorrect type. Only certified engineers should replace the on-board battery.

Dispose of used batteries according to instructions and local regulations.

- Outside the European Union–If you wish to dispose of used electrical and electronic products outside the European Union, please contact your local authority so as to comply with the correct disposal method.
- Within the European Union–The device that produces less waste and is easier to recycle is classified as electronic device in terms of the European Directive 2012/19/EU (WEEE), and must not be disposed of as domestic garbage.

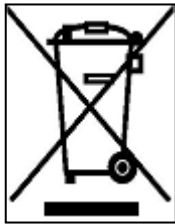

EU-wide legislation, as implemented in each Member State, requires that waste electrical and electronic products carrying the mark (left) must be disposed of separately from normal household waste. This includes monitors and electrical accessories, such as signal cables or power cords. When you need to dispose of your device, please follow the guidance of your local authority, or ask the shop where you purchased the product. The mark on electrical and electronic products only applies to the current European Union Member States.

Please follow the national guidelines for electrical and electronic product disposal.

Appendix

C

BIOS Menu Options

<input type="checkbox"/>	System Date [xx/xx/xx]	63
<input type="checkbox"/>	System Time [xx:xx:xx]	63
<input type="checkbox"/>	Intel® (VMX) Virtualization Technology [Disabled]	64
<input type="checkbox"/>	Active Processor Cores [All]	65
<input type="checkbox"/>	Hyper-threading [Enabled]	65
<input type="checkbox"/>	Intel® SpeedStep™ [Enabled]	65
<input type="checkbox"/>	C State [Disabled]	65
<input type="checkbox"/>	AMT BIOS Features [Enabled]	66
<input type="checkbox"/>	Unconfigure ME [Disabled]	66
<input type="checkbox"/>	TPM Device Selection [dTPM (If supported)]	67
<input type="checkbox"/>	ACPI Sleep State [S3 (Suspend to RAM)]	68
<input type="checkbox"/>	Wake system with Fixed Time [Disabled]	69
<input type="checkbox"/>	PC Health Status	70
<input type="checkbox"/>	CPU_FAN1 Smart Fan Control [Auto Mode]	71
<input type="checkbox"/>	Auto mode fan start temperature [40]	72
<input type="checkbox"/>	Auto mode fan off temperature [30]	72
<input type="checkbox"/>	Auto mode fan start PWM [30]	72
<input type="checkbox"/>	Auto mode fan slope PWM [2]	73
<input type="checkbox"/>	Serial Port [Enabled]	74
<input type="checkbox"/>	Transfer Mode [RS232]	74
<input type="checkbox"/>	Console Redirection [Disabled]	75
<input type="checkbox"/>	Legacy Serial Redirection Port [COM1]	76
<input type="checkbox"/>	Terminal Type [ANSI]	77
<input type="checkbox"/>	Bits per second [115200]	78
<input type="checkbox"/>	Data Bits [8]	78
<input type="checkbox"/>	Parity [None]	78
<input type="checkbox"/>	Stop Bits [1]	79
<input type="checkbox"/>	USB Devices	79
<input type="checkbox"/>	Legacy USB Support [Enabled]	80
<input type="checkbox"/>	Auto Recovery Function [Disabled]	81
<input type="checkbox"/>	VT-d [Disabled]	83
<input type="checkbox"/>	Primary Display [Auto]	84
<input type="checkbox"/>	Internal Graphics [Enabled]	84
<input type="checkbox"/>	DVMT Pre-Allocated [32M]	85
<input type="checkbox"/>	DVMT Total Gfx Mem [MAX]	85

WAFER-ULT5 SBC

<input type="checkbox"/>	Primary IGFX Boot Display [VBIOS Default]	85
<input type="checkbox"/>	Restore AC Power Loss [Last State]	86
<input type="checkbox"/>	Power Saving Function(ERP) [Disabled].....	87
<input type="checkbox"/>	USB Power SW [+5V DUAL].....	87
<input type="checkbox"/>	HD Audio [Enabled]	87
<input type="checkbox"/>	MINI_PCIE1 / M2_A1 [Enabled]	89
<input type="checkbox"/>	PCIe Speed [Auto].....	89
<input type="checkbox"/>	Detect Non-Compliance Device [Disabled]	89
<input type="checkbox"/>	STAT Controller(s) [Enabled].....	90
<input type="checkbox"/>	SATA Mode Selection [AHCI].....	90
<input type="checkbox"/>	Hot Plug [Disabled]	91
<input type="checkbox"/>	Administrator Password	92
<input type="checkbox"/>	User Password	92
<input type="checkbox"/>	Bootup NumLock State [On].....	93
<input type="checkbox"/>	Quiet Boot [Enabled]	94
<input type="checkbox"/>	Launch PXE OpROM [Disabled]	94
<input type="checkbox"/>	Option ROM Messages [Force BIOS].....	94
<input type="checkbox"/>	UEFI Boot [Disabled]	94
<input type="checkbox"/>	Boot Option Priority.....	94
<input type="checkbox"/>	Save Changes and Reset	95
<input type="checkbox"/>	Discard Changes and Reset	95
<input type="checkbox"/>	Restore Defaults	95
<input type="checkbox"/>	Save as User Defaults	96
<input type="checkbox"/>	Restore User Defaults	96

Appendix

D

Digital I/O Interface

WAFER-ULT5 SBC

The DIO connector on the WAFER-ULT5 is interfaced to GPIO ports on the Super I/O chipset. The DIO has both 8-bit digital inputs and 8-bit digital outputs. The digital inputs and digital outputs are generally control signals that control the on/off circuit of external devices or TTL devices. Data can be read or written to the selected address to enable the DIO functions.



NOTE:

For further information, please refer to the datasheet for the Super I/O chipset.

The BIOS interrupt call **INT 15H** controls the digital I/O.

INT 15H:

AH – 6FH	
<u>Sub-function:</u>	
AL – 8	:Set the digital port as INPUT
AL	:Digital I/O input value

Assembly Language Sample 1

```
MOV    AX, 6F08H    ;setting the digital port as input
INT    15H          ;
```

AL low byte = value

AH – 6FH	
<u>Sub-function:</u>	
AL – 9	:Set the digital port as OUTPUT
BL	:Digital I/O output value

Assembly Language Sample 2

```

MOV    AX, 6F09H      ;setting the digital port as output
MOV    BL, 09H        ;digital value is 09H
INT    15H           ;
    
```

Digital Output is 1001b

Appendix

E

Watchdog Timer



NOTE:

The following discussion applies to DOS. Contact IEI support or visit the IEI website for drivers for other operating systems.

The Watchdog Timer is a hardware-based timer that attempts to restart the system when it stops working. The system may stop working because of external EMI or software bugs. The Watchdog Timer ensures that standalone systems like ATMs will automatically attempt to restart in the case of system problems.

A BIOS function call (INT 15H) is used to control the Watchdog Timer.

INT 15H:

AH – 6FH Sub-function:	
AL – 2:	Sets the Watchdog Timer's period.
BL:	Time-out value (Its unit-second is dependent on the item "Watchdog Timer unit select" in CMOS setup).

Table E-1: AH-6FH Sub-function

Call sub-function 2 to set the time-out period of Watchdog Timer first. If the time-out value is not zero, the Watchdog Timer starts counting down. When the timer value reaches zero, the system resets. To ensure that this reset condition does not occur, calling sub-function 2 must periodically refresh the Watchdog Timer. However, the watchdog timer is disabled if the time-out value is set to zero.

A tolerance of at least 10% must be maintained to avoid unknown routines within the operating system (DOS), such as disk I/O that can be very time-consuming.

WAFER-ULT5 SBC



NOTE:

The Watchdog Timer is activated through software. The software application that activates the Watchdog Timer must also deactivate it when closed. If the Watchdog Timer is not deactivated, the system will automatically restart after the Timer has finished its countdown.

EXAMPLE PROGRAM:

; INITIAL TIMER PERIOD COUNTER

;

W_LOOP:

;

```

MOV      AX, 6F02H      ;setting the time-out value
MOV      BL, 30         ;time-out value is 48 seconds
INT      15H

```

;

; ADD THE APPLICATION PROGRAM HERE

;

```

CMP      EXIT_AP, 1     ;is the application over?
JNE      W_LOOP        ;No, restart the application

MOV      AX, 6F02H     ;disable Watchdog Timer
MOV      BL, 0         ;
INT      15H

```

;

; EXIT ;

Appendix

F

Error Beep Code

WAFER-ULT5 SBC

F.1 PEI Beep Codes

Number of Beeps	Description
1	Memory not Installed
1	Memory was installed twice (InstallPeiMemory routine in PEI Core called twice)
2	Recovery started
3	DXE IPL was not found
3	DXE Core Firmware Volume was not found
4	Recovery failed
4	S3 Resume failed
7	Reset PPI is not available

F.2 DXE Beep Codes

Number of Beeps	Description
1	Invalid password
4	Some of the Architectural Protocols are not available
5	No Console Output Devices are found
5	No Console Input Devices are found
6	Flash update is failed
7	Reset protocol is not available
8	Platform PCI resource requirements cannot be met



NOTE:

If you have any question, please contact IEI for further assistance.

Appendix

G

Hazardous Materials Disclosure

WAFER-ULT5 SBC

G.1 RoHS II Directive (2015/863/EU)

The details provided in this appendix are to ensure that the product is compliant with the RoHS II Directive (2015/863/EU). The table below acknowledges the presences of small quantities of certain substances in the product, and is applicable to RoHS II Directive (2015/863/EU).

Please refer to the following table.

Part Name	Toxic or Hazardous Substances and Elements									
	Lead (Pb)	Mercury (Hg)	Cadmium (Cd)	Hexavalent Chromium (CR(VI))	Polybrominated Biphenyls (PBB)	Polybrominated Diphenyl Ethers (PBDE)	Bis(2-ethylhexyl) phthalate (DEHP)	Butyl benzyl phthalate (BBP)	Dibutyl phthalate (DBP)	Diisobutyl phthalate (DIBP)
Housing	O	O	O	O	O	O	O	O	O	O
Printed Circuit Board	O	O	O	O	O	O	O	O	O	O
Metal Fasteners	O	O	O	O	O	O	O	O	O	O
Cable Assembly	O	O	O	O	O	O	O	O	O	O
Fan Assembly	O	O	O	O	O	O	O	O	O	O
Power Supply Assemblies	O	O	O	O	O	O	O	O	O	O
Battery	O	O	O	O	O	O	O	O	O	O
<p>O: This toxic or hazardous substance is contained in all of the homogeneous materials for the part is below the limit requirement in Directive (EU) 2015/863.</p> <p>X: This toxic or hazardous substance is contained in at least one of the homogeneous materials for this part is above the limit requirement in Directive (EU) 2015/863.</p>										

G.2 China RoHS

此附件旨在确保本产品符合中国 RoHS 标准。以下表格标示此产品中某有毒物质的含量符合中国 RoHS 标准规定的限量要求。

本产品上会附有“环境友好使用期限”的标签，此期限是估算这些物质“不会有泄漏或突变”的年限。本产品可能包含有较短的环境友好使用期限的可替换元件，像是电池或灯管，这些元件将会单独标示出来。

部件名称	有毒有害物质或元素					
	铅 (Pb)	汞 (Hg)	镉 (Cd)	六价铬 (CR(VI))	多溴联苯 (PBB)	多溴二苯醚 (PBDE)
壳体	○	○	○	○	○	○
印刷电路板	○	○	○	○	○	○
金属螺帽	○	○	○	○	○	○
电缆组装	○	○	○	○	○	○
风扇组装	○	○	○	○	○	○
电力供应组装	○	○	○	○	○	○
电池	○	○	○	○	○	○

○: 表示该有毒有害物质在该部件所有物质材料中的含量均在 SJ/T11364-2014 與 GB/T26572-2011 标准规定的限量要求以下。

X: 表示该有毒有害物质至少在该部件的某一均质材料中的含量超出 SJ/T11364-2014 與 GB/T26572-2011 标准规定的限量要求。