

MODEL:
WAFER-BT

3.5" SBC with Intel® 22nm Quad-Core Celeron® on-board SoC,
VGA/LVDS/iDP, Dual PCIe GbE, USB 3.0, PCIe Mini,
SATA 3Gb/s, mSATA, COM, Audio and RoHS

User Manual

Revision

Date	Version	Changes
July 5, 2018	2.00	Updated to R20 version
June 19, 2018	1.05	Updated BIOS spec on page 7
January 12, 2017	1.04	Updated Section 2.4: Optional Items Updated Chapter 3: Connectors Added a notice for downloading BIOS from IEI website in Chapter 5.
August 26, 2015	1.03	Updated Figure 1-3: Dimensions (mm) Updated Section 2: Unpacking Updated Table 3-17: RS-232 Serial Port Connector Pinouts Added Section 4.7: Chassis Installation Added notices for mSATA and SATA2 usage
February 13, 2015	1.02	Updated Section 1.5: Dimensions
January 26, 2015	1.01	Updated Section 3.2.23: USB connectors pinouts
July 7, 2014	1.00	Initial release

Copyright

COPYRIGHT NOTICE

The information in this document is subject to change without prior notice in order to improve reliability, design and function and does not represent a commitment on the part of the manufacturer.

In no event will the manufacturer be liable for direct, indirect, special, incidental, or consequential damages arising out of the use or inability to use the product or documentation, even if advised of the possibility of such damages.

This document contains proprietary information protected by copyright. All rights are reserved. No part of this manual may be reproduced by any mechanical, electronic, or other means in any form without prior written permission of the manufacturer.

TRADE MARKS

All registered trademarks and product names mentioned herein are used for identification purposes only and may be trademarks and/or registered trademarks of their respective owners.

Manual Conventions



WARNING

Warnings appear where overlooked details may cause damage to the equipment or result in personal injury. Warnings should be taken seriously.



CAUTION

Cautionary messages should be heeded to help reduce the chance of losing data or damaging the product.



NOTE

These messages inform the reader of essential but non-critical information. These messages should be read carefully as any directions or instructions contained therein can help avoid making mistakes.



HOT SURFACE

This symbol indicates a hot surface that should not be touched without taking care.

Table of Contents

1 INTRODUCTION	1
1.1 INTRODUCTION	2
1.2 FEATURES	2
1.3 CONNECTORS.....	3
1.4 DIMENSIONS.....	4
1.5 DATA FLOW.....	5
1.6 TECHNICAL SPECIFICATIONS.....	6
2 UNPACKING	8
2.1 ANTI-STATIC PRECAUTIONS.....	9
2.2 UNPACKING PRECAUTIONS	9
2.3 PACKING LIST.....	10
2.4 OPTIONAL ITEMS.....	11
3 CONNECTORS	12
3.1 PERIPHERAL INTERFACE CONNECTORS.....	13
3.1.1 WAFER-BT Layout.....	13
3.1.2 Peripheral Interface Connectors	13
3.1.3 External Interface Panel Connectors.....	15
3.2 INTERNAL PERIPHERAL CONNECTORS.....	15
3.2.1 +12V DC-IN Power Connector	15
3.2.2 Audio Connector	16
3.2.3 Battery Connector.....	17
3.2.4 Buzzer Connector.....	18
3.2.5 Fan Connectors.....	19
3.2.6 DDR3L SO-DIMM Slot.....	20
3.2.7 Digital I/O Connector	20
3.2.8 Display Port Connector	21
3.2.9 Front Panel Connector	22
3.2.10 Keyboard and Mouse Connector	23
3.2.11 LVDS Backlight Inverter Connector	24

3.2.12 LVDS LCD Connector	25
3.2.13 LAN LED Connector.....	27
3.2.14 PCIe Mini Card Slot	27
3.2.15 Power Button Connector.....	28
3.2.16 Reset Button Connector	29
3.2.17 RS-232 Serial Port Connectors.....	30
3.2.18 RS-422/485 Serial Port Connector	31
3.2.19 SATA 3Gb/s Drive Connectors.....	32
3.2.20 SATA Power Connectors	33
3.2.21 SMBus Connector	34
3.2.22 USB Connectors.....	34
3.3 EXTERNAL PERIPHERAL INTERFACE CONNECTOR PANEL	35
3.3.1 LAN Connector	36
3.3.2 USB Connectors.....	37
3.3.3 RS-232 Serial Port Connector	38
3.3.4 VGA Connector	38
4 INSTALLATION.....	40
4.1 ANTI-STATIC PRECAUTIONS.....	41
4.2 INSTALLATION CONSIDERATIONS	41
4.3 SO-DIMM INSTALLATION.....	43
4.4 FULL-SIZE PCIe MINI CARD INSTALLATION.....	44
4.5 HALF-SIZE PCIe MINI CARD INSTALLATION.....	47
4.6 SYSTEM CONFIGURATION.....	49
4.6.1 AT/ATX Mode Select Switch.....	49
4.6.2 Clear CMOS Button.....	50
4.6.3 LVDS Panel Resolution Selection	50
4.6.4 LVDS Voltage Selection.....	52
4.6.5 Flash Descriptor Security Override Jumper.....	53
4.7 CHASSIS INSTALLATION	54
4.7.1 Heat Sink Enclosure.....	54
4.7.2 Motherboard Installation.....	54
4.8 INTERNAL PERIPHERAL DEVICE CONNECTIONS.....	55
4.8.1 Audio Kit Installation.....	55
4.8.2 SATA Drive Connection	56

WAFER-BT

4.8.3 Single RS-232 Cable	57
4.9 DRIVER DOWNLOAD	59
5 BIOS	61
5.1 INTRODUCTION	62
5.1.1 Starting Setup	62
5.1.2 Using Setup	62
5.1.3 Getting Help	63
5.1.4 Unable to Reboot after Configuration Changes	63
5.1.5 BIOS Menu Bar	63
5.2 MAIN	64
5.3 ADVANCED	65
5.3.1 ACPI Settings	66
5.3.2 Super IO Configuration	67
5.3.2.1 Serial Port n Configuration	67
5.3.3 Hardware Monitor	71
5.3.4 iWDD H/W Monitor	72
5.3.4.1 Smart Fan Mode Configuration	73
5.3.5 RTC Wake Settings	74
5.3.6 Serial Port Console Redirection	75
5.3.6.1 Console Redirection Settings	76
5.3.7 IEI Feature	78
5.3.8 CPU Configuration	79
5.3.8.1 Socket 0 CPU Information	80
5.3.9 IDE Configuration	81
5.3.10 USB Configuration	82
5.4 CHIPSET	83
5.4.1 North Bridge Configuration	84
5.4.1.1 Intel IGD Configuration	85
5.4.2 Southbridge Configuration	88
5.4.2.1 PCI Express Configuration	89
5.5 SECURITY	91
5.6 BOOT	92
5.7 EXIT	94
5.8 SERVER MGMT	95

5.8.1.1 System Event Log	96
5.8.1.2 BMC network configuration	97
A REGULATORY COMPLIANCE.....	98
B PRODUCT DISPOSAL.....	100
C BIOS MENU OPTIONS	102
D TERMINOLOGY	105
E DIGITAL I/O INTERFACE.....	110
F WATCHDOG TIMER.....	113
G HAZARDOUS MATERIALS DISCLOSURE	116

List of Figures

Figure 1-1: WAFER-BT	2
Figure 1-2: Connectors	3
Figure 1-3: Dimensions (mm)	4
Figure 1-4: Data Flow Diagram	5
Figure 3-1: Connector and Jumper Locations (Front)	13
Figure 3-2: +12V DC-IN Power Connector Location	16
Figure 3-3: Audio Connector Location	17
Figure 3-4: Battery Connector Location	18
Figure 3-5: Buzzer Connector Location	19
Figure 3-6: Fan Connector Locations	19
Figure 3-7: DDR3L SO-DIMM Slot Location	20
Figure 3-8: Digital I/O Connector Location	21
Figure 3-9: Display Port Connector Location	22
Figure 3-10: Front Panel Connector Location	23
Figure 3-11: Keyboard and Mouse Location	24
Figure 3-12: Backlight Inverter Connector Location	25
Figure 3-13: LVDS Connector Location	26
Figure 3-14: LAN LED Connector Location	27
Figure 3-15: PCIe Mini Card Slot Location	28
Figure 3-16: Power Button Connector Location	29
Figure 3-17: Reset Button Connector Location	30
Figure 3-18: RS-232 Serial Port Connectors Locations	30
Figure 3-19: RS-422/485 Connector Location	31
Figure 3-20: SATA 3Gb/s Drive Connectors Locations	32
Figure 3-21: SATA Power Connector Locations	33
Figure 3-22: SMBus Connectors Location	34
Figure 3-23: USB Connectors Locations	35
Figure 3-24: External Peripheral Interface Connector	36
Figure 3-25: LAN Connector	36
Figure 3-26: RS-232 Serial Port Connector	38
Figure 3-27: VGA Connector	39

Figure 4-1: SO-DIMM Installation	43
Figure 4-2: Removing the Retention Screw	44
Figure 4-3: Removing the Retention Screw and Standoff	45
Figure 4-4: Inserting the Full-size PCIe Mini Card into the Slot at an Angle	45
Figure 4-5: Securing the Full-size PCIe Mini Card	46
Figure 4-6: Removing the Retention Screw	47
Figure 4-7: Inserting the Half-size PCIe Mini Card into the Slot at an Angle	48
Figure 4-8: Securing the Half-size PCIe Mini Card	48
Figure 4-9: AT/ATX Mode Select Switch Location	49
Figure 4-10: Clear CMOS Button Location	50
Figure 4-11: LVDS Panel Resolution Selection Switch Location	51
Figure 4-12: LVDS Voltage Selection Jumper Location	52
Figure 4-13: Flash Descriptor Security Override Jumper Location	53
Figure 4-14: Motherboard Installation Example	55
Figure 4-15: Audio Kit Cable Connection	56
Figure 4-16: SATA Drive Cable Connection	57
Figure 4-17: Single RS-232 Cable Installation	58

List of Tables

Table 1-1: Technical Specifications	7
Table 3-1: Peripheral Interface Connectors	14
Table 3-2: Rear Panel Connectors	15
Table 3-3: +12V DC-IN Power Connector Pinouts	16
Table 3-4: Audio Connector Pinouts	17
Table 3-5: Battery Connector Pinouts	18
Table 3-6: Buzzer Connector Pinouts	19
Table 3-7: Fan Connector Pinouts	20
Table 3-8: Digital I/O Connector Pinouts	21
Table 3-9: Display Port Connector Pinouts	22
Table 3-10: Front Panel Connector Pinouts	23
Table 3-11: Keyboard and Mouse Connector Pinouts	24
Table 3-12: Backlight Inverter Connector Pinouts	25
Table 3-13: LVDS Connector Pinouts	26
Table 3-14: LAN LED Connector Pinouts	27
Table 3-15: Power Button Connector Pinouts	29
Table 3-16: Reset Button Connector Pinouts	30
Table 3-17: RS-232 Serial Port Connector Pinouts	31
Table 3-18: RS-422/485 Connector Pinouts	31
Table 3-19: DB-9 RS-422/485 Pinouts	32
Table 3-20: SATA Power Connector Pinouts	33
Table 3-21: SMBus Connectors Pinouts	34
Table 3-22: USB Connectors Pinouts	35
Table 3-23: LAN Pinouts	36
Table 3-24: Connector LEDs	37
Table 3-25: USB 2.0 Port Pinouts	37
Table 3-26: USB 3.0 Port Pinouts	37
Table 3-27: RS-232 Serial Port Connector Pinouts	38
Table 3-28: VGA Connector Pinouts	39
Table 4-1: AT/ATX Mode Select Switch Settings	49
Table 4-2: Clear CMOS Button Settings	50

Table 4-3: LVDS Panel Resolution Selection	51
Table 4-4: LVDS Voltage Selection Jumper Settings	52
Table 4-5: Flash Descriptor Security Override Jumper Settings	53
Table 5-1: BIOS Navigation Keys	63

List of BIOS Menus

BIOS Menu 1: Main	64
BIOS Menu 2: Advanced	65
BIOS Menu 3: ACPI Configuration	66
BIOS Menu 4: Super IO Configuration.....	67
BIOS Menu 5: Serial Port n Configuration Menu	67
BIOS Menu 6: Hardware Monitor.....	71
BIOS Menu 7: Hardware Monitor.....	72
BIOS Menu 8: Smart Fan Mode Configuration	73
BIOS Menu 9: RTC Wake Settings	74
BIOS Menu 10: Serial Port Console Redirection	75
BIOS Menu 11: Console Redirection Settings.....	76
BIOS Menu 12: IEI Feature	78
BIOS Menu 13: CPU Configuration	79
BIOS Menu 14: CPU Configuration	80
BIOS Menu 15: IDE Configuration	81
BIOS Menu 16: USB Configuration	82
BIOS Menu 17: Chipset	84
BIOS Menu 18: Northbridge Chipset Configuration.....	84
BIOS Menu 19: Integrated Graphics	85
BIOS Menu 20: Southbridge Chipset Configuration	88
BIOS Menu 21: Console Redirection Settings.....	90
BIOS Menu 22: Security	91
BIOS Menu 23: Boot	92
BIOS Menu 24: Exit.....	94
BIOS Menu 25: Server Mgmt	95
BIOS Menu 26: System Event Log	96
BIOS Menu 27: PCH Azalia Configuration Menu	97

Chapter

1

Introduction

1.1 Introduction

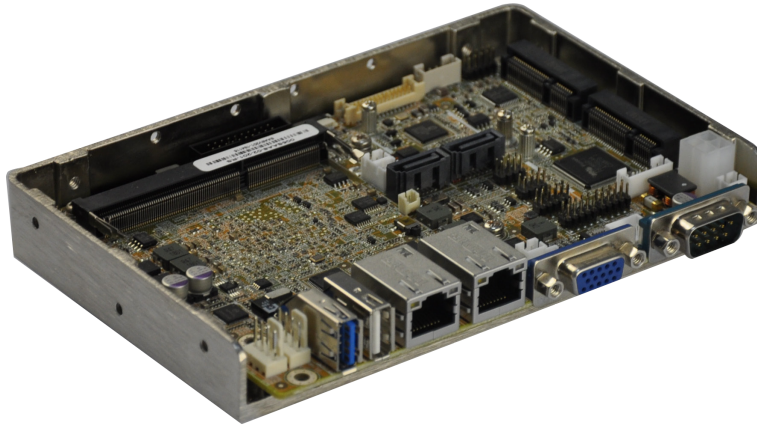

Figure 1-1: WAFER-BT

The WAFER-BT is a SBC motherboard. It accepts an Intel® Celeron® J1900/N2807 on-board SoC and supports one 204-pin 1066/1333 MHz single-channel DDR3L SO-DIMM up to 8GB (J1900) or 4GB (N2807).

The WAFER-BT includes a VGA connector, a LVDS connector and an iDP connector. Expansion and I/O include one USB 2.0 connector and one USB 3.0 connector on the rear panel, four USB 2.0 connectors by pin header and two SATA 3Gb/s connectors. Serial device connectivity is provided by two internal RS-232 connectors, one external RS-232 connector and one internal RS-422/485 connector. Two RJ-45 Ethernet connectors provide the system with smooth connections to an external LAN.

1.2 Features

Some of the WAFER-BT motherboard features are listed below:

- 3.5" SBC supports 22nm Intel® Celeron® J1900/N2807 on-board SoC
- Dual independent display support
- One 204-pin 1066/1333 MHz single-channel DDR3L SO-DIMM supports up to 8GB (J1900) or 4GB (N2807)
- COM, USB 3.0, SATA 3Gb/s, PCIE mini, mSATA and Audio support

WAFER-BT

1.3 Connectors

The connectors on the WAFER-BT are shown in the figure below.

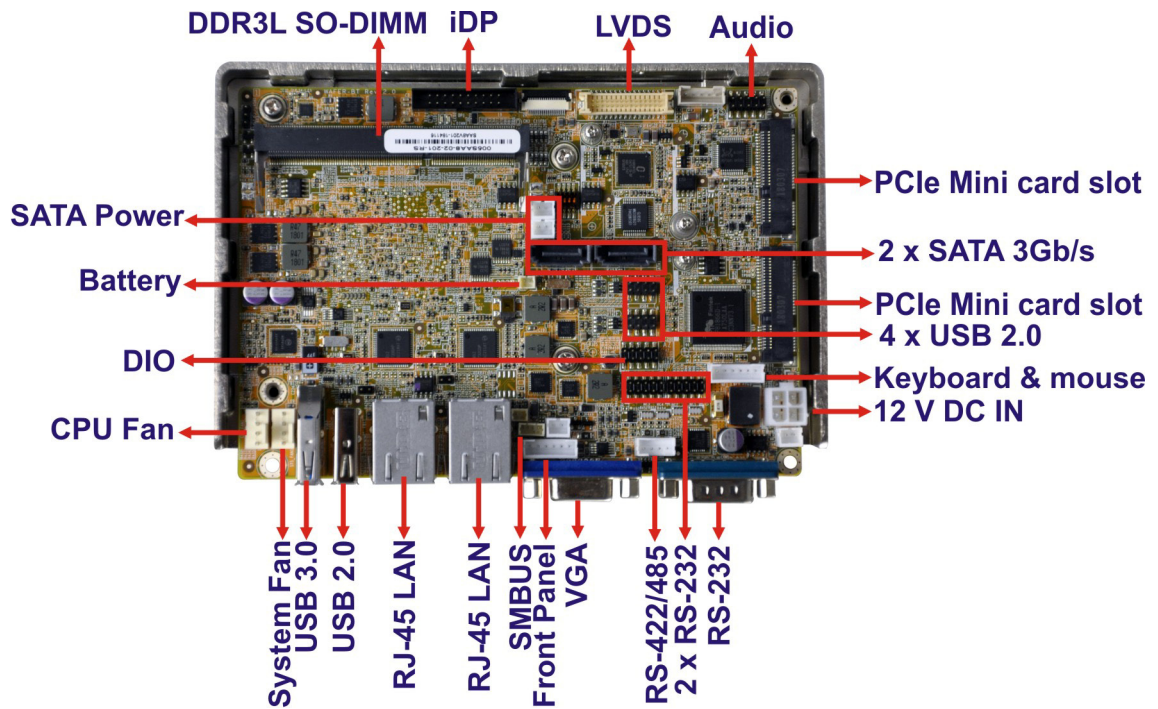

Figure 1-2: Connectors

1.4 Dimensions

The dimensions of the board are listed below:

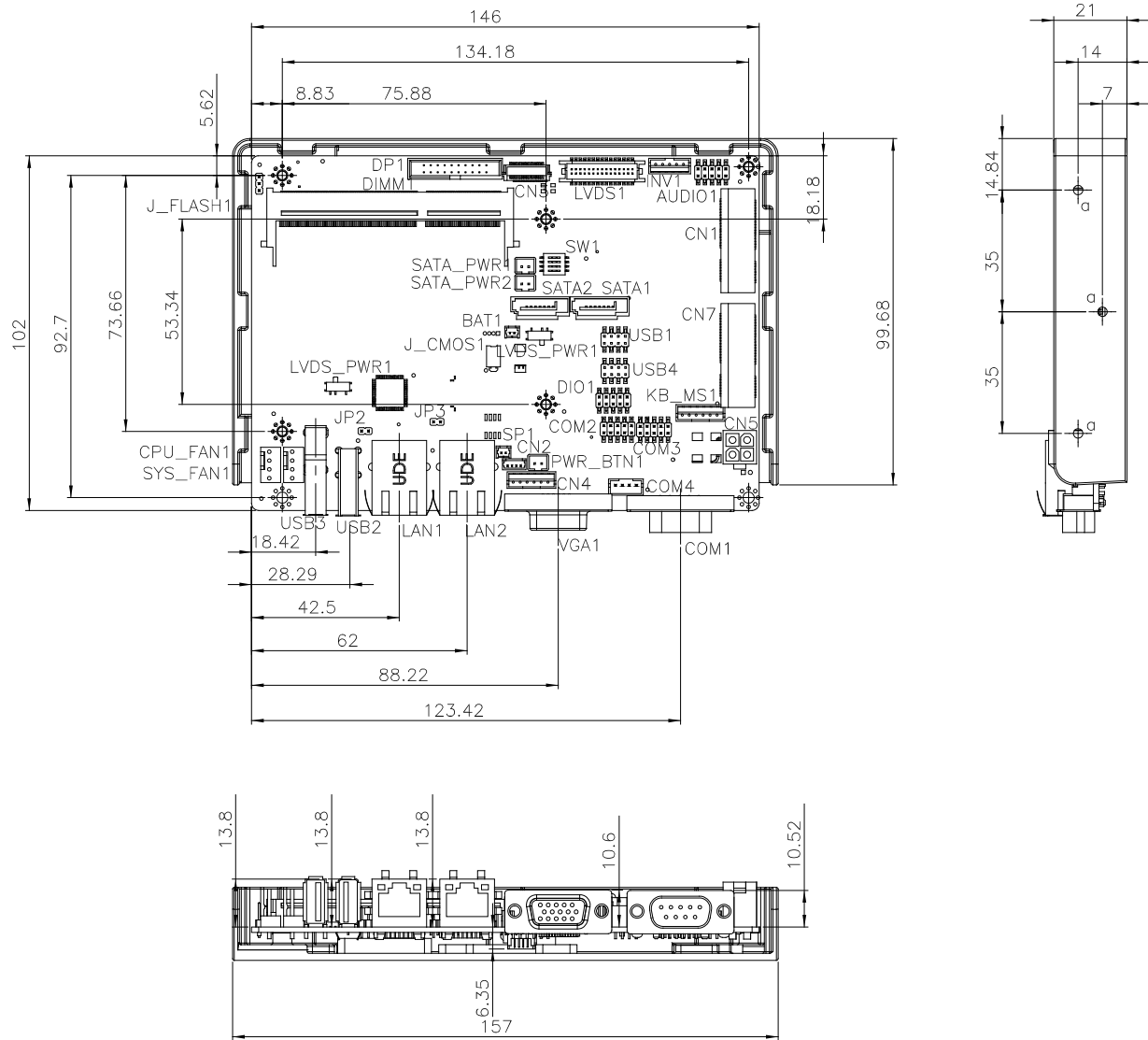

Figure 1-3: Dimensions (mm)

WAFER-BT

1.5 Data Flow

Figure 1-4 shows the data flow between the system chipset, the CPU and other components installed on the motherboard.

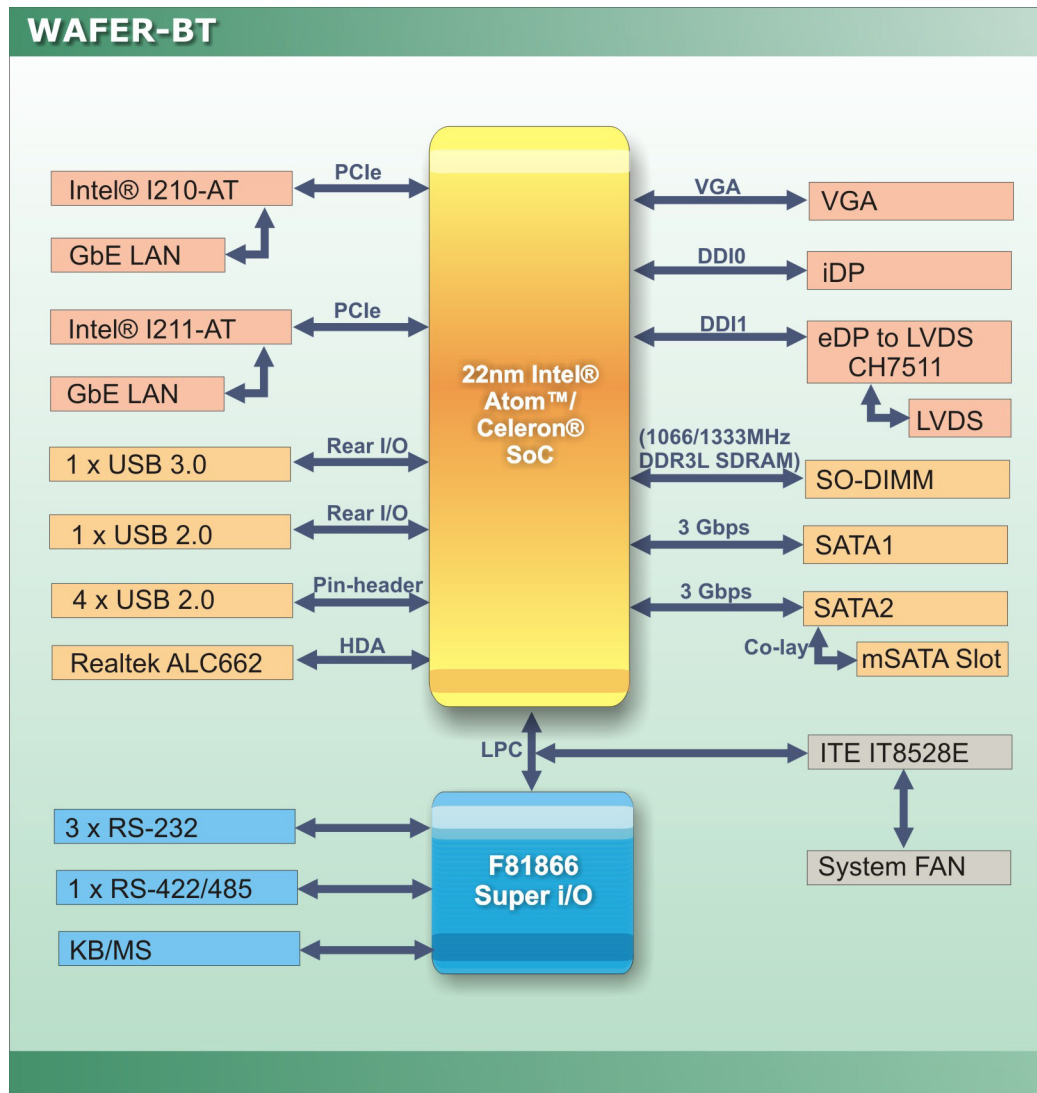

Figure 1-4: Data Flow Diagram

1.6 Technical Specifications

WAFER-BT technical specifications are listed below.

Specification	WAFER-BT
SoC	Intel® Celeron® J1900 on-board SoC (2GHz, quad-core, 2MB cache, TDP=10W) Intel® Celeron® N2807 on-board SoC (1.58GHz, dual-core, 2MB cache, TDP=4.3W)
BIOS	AMI UEFI BIOS
Memory	One 204-pin 1066/1333 MHz single-channel DDR3L SO-DIMM slot supports up to 8 GB
Graphics	4th Gen 7 Graphics Engines with 4 execution unit, DX11, OGL 4.0, ES 2.0, OpenCL 1.2 support
Display Output	Dual Independent Display 1 x VGA (2560x1600@60Hz) 1 x 24-bit dual-channel LVDS connector (1920x1200@60Hz) 1 x iDP interface for HDMI, LVDS, VGA, DVI, DP (up to 3840x2160@60 Hz)
Ethernet	1 x PCIe GbE by Intel I210 controller (LAN1) 1 x PCIe GbE by Intel I211 controller (LAN2)
Super IO	Fintek F81866
Embedded Controller	ITE IT8528E
Audio	Realtek ALC662 HD codec
Watchdog Timer	Software programmable support 1~255 sec. system reset
I/O Interface	
Audio Connector	1 x Analog audio by 10-pin (2x5) header
Ethernet	Two RJ-45 ports
KB/MS	1 x KB/MS (by pin header)
Serial Ports	1 x RS-422/485 (by pin header) 3 x RS-232 (1 on rear I/O, 2 by pin header)

WAFER-BT

Specification	WAFER-BT
USB Ports	1 x USB 3.0 (on rear I/O) 5 x USB 2.0 (1 on rear I/O, 4 by pin header)
Front Panel	1 x 6-pin (1x6) wafer for power LED & HDD LED 1 x 2-pin (1x2) wafer for power button 1 x 2-pin (1x2) wafer for power reset button
LAN LED	2 x 2-pin header for LAN1 Link LED, LAN2 Link LED
Fan	1 x 4-pin CPU fan connector 1 x 4-pin system fan connector
SMBus	1 x 4-pin (1x4) wafer
Expansion	1 x Full-size PCIe Mini card slot with mSATA support (mSATA colay with SATA port 2) 1 x Half-size PCIe mini card slot (support PCIe signal)
Digital I/O	8-bit digital I/O (4-bit input, 4-bit output)
Storage	
Serial ATA	2 x SATA 3Gb/s with 5V SATA power connector (no RAID)
Environmental and Power Specifications	
Power Supply	12V DC input only (AT/ATX support)
Power Consumption	12V@1.45A (Intel® Celeron® J1900 with 8GB 1333MHz DDR3 memory)
Operating Temperature	-20°C ~ 60°C
Storage Temperature	-20°C ~ 85°C
Humidity	5% ~ 95%, non-condensing
Physical Specifications	
Dimensions	146 mm x 102 mm
Weight GW/NW	600 g / 250 g
Safety/EMC	CE/FCC

Table 1-1: Technical Specifications

Chapter

2

Unpacking

WAFER-BT

2.1 Anti-static Precautions



WARNING!

Static electricity can destroy certain electronics. Make sure to follow the ESD precautions to prevent damage to the product, and injury to the user.

Make sure to adhere to the following guidelines:

- **Wear an anti-static wristband:** Wearing an anti-static wristband can prevent electrostatic discharge.
- **Self-grounding:** Touch a grounded conductor every few minutes to discharge any excess static buildup.
- **Use an anti-static pad:** When configuring any circuit board, place it on an anti-static mat.
- **Only handle the edges of the PCB:** Don't touch the surface of the motherboard. Hold the motherboard by the edges when handling.

2.2 Unpacking Precautions

When the WAFER-BT is unpacked, please do the following:

- Follow the antistatic guidelines above.
- Make sure the packing box is facing upwards when opening.
- Make sure all the packing list items are present.





2.3 Packing List



NOTE:

If any of the components listed in the checklist below are missing, do not proceed with the installation. Contact the IEI reseller or vendor the WAFER-BT was purchased from or contact an IEI sales representative directly by sending an email to sales@ieiworld.com.









The WAFER-BT is shipped with the following components:

Quantity	Item and Part Number	Image
1	WAFER-BT single board computer with heat spreader	
1	Audio cable (P/N: 32000-072100-RS)	
1	SATA with 5V output cable kit (P/N: 32801-000201-100-RS)	
1	Power cable (P/N: 32100-087100-RS)	
1	Quick Installation Guide	

WAFER-BT

2.4 Optional Items

The following are optional components which may be separately purchased:

Item and Part Number	Image
Dual-port USB cable without bracket (P/N: 32000-070301-RS)	
RS-422/485 cable (P/N: 32205-003800-300-RS)	
PS/2 KB/MS Y-cable without bracket (P/N: 32006-000300-100-RS)	
DisplayPort to 24-bit dual-channel LVDS converter board for IEI iDP connector (P/N: DP-LVDS-R10)	
DisplayPort to HDMI converter board for IEI iDP connector (P/N: DP-HDMI-R10)	
DisplayPort to VGA converter board for IEI iDP connector (P/N: DP-VGA-R10)	
DisplayPort to DVI-D converter board for IEI iDP connector (P/N: DP-DVI-R10)	
DisplayPort to DisplayPort converter board for IEI iDP connector (P/N: DP-DP-R10)	

Chapter

3

Connectors

WAFER-BT

3.1 Peripheral Interface Connectors

This chapter details all the jumpers and connectors.

3.1.1 WAFER-BT Layout

The figures below show all the connectors and jumpers.

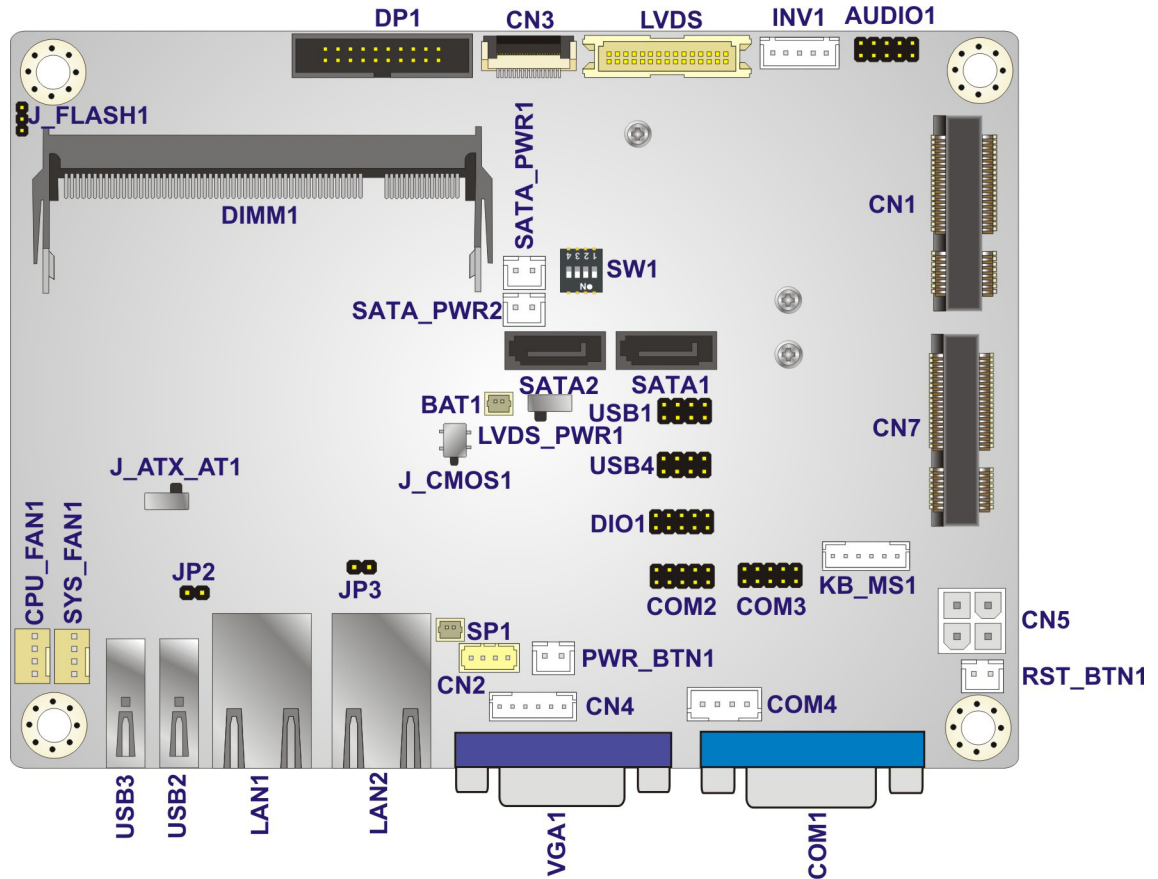

Figure 3-1: Connector and Jumper Locations (Front)

3.1.2 Peripheral Interface Connectors

The table below lists all the connectors on the board.

Connector	Type	Label
+12V DC-IN power connector	4-pin Molex	CN5
Audio connector	10-pin header	AUDIO1

Battery connector	2-pin wafer	BAT1
Buzzer connector	2-pin wafer	SP1
CPU fan connector	4-pin wafer	CPU_FAN1
System fan connector	4-pin wafer	SYS_FAN1
DDR3L SO-DIMM slot	DDR3L SO-DIMM slot	DIMM1
Digital I/O connector	10-pin header	DIO1
Display port connector	20-pin header	DP1
Front panel connector	6-pin wafer	CN4
Keyboard & mouse connector	6-pin wafer	KB_MS1
LVDS panel Connector	30-pin crimp	LVDS1
LCD panel backlight power connector	5-pin wafer	INV1
LAN LED connector	2-pin header	JP2, JP3
PCIe Mini card slot	PCIe Mini card slot	CN1, CN7
Power button connector	2-pin wafer	PWR_BTN1
Reset button connector	2-pin wafer	RST_BTN1
RS-232 serial port connectors	10-pin header	COM2, COM3
RS-422/485 serial port connector	4-pin wafer	COM4
SATA 3Gb/s drive connectors	7-pin SATA connector	SATA1, SATA2
SATA power connectors	2-pin wafer	SATA_PWR1, SATA_PWR2
SMBus connector	4-pin wafer	CN2
USB 2.0 connectors	8-pin header	USB1, USB4

Table 3-1: Peripheral Interface Connectors

WAFER-BT

3.1.3 External Interface Panel Connectors

The table below lists the connectors on the external I/O panel.

Connector	Type	Label
LAN connectors	RJ-45	LAN1, LAN2
RS-232 serial port connector	DB-9 male	COM1
USB 2.0 connector	USB 2.0	USB2
USB 3.0 connector	USB 3.0	USB3
VGA Connector	15-pin female	VGA1

Table 3-2: Rear Panel Connectors

3.2 Internal Peripheral Connectors

The section describes all of the connectors on the WAFER-BT.

3.2.1 +12V DC-IN Power Connector

CN Label:	CN5
CN Type:	4-pin Molex, p=4.2 mm
CN Location:	See Figure 3-2
CN Pinouts:	See Table 3-3

The connector supports the +12V power supply.

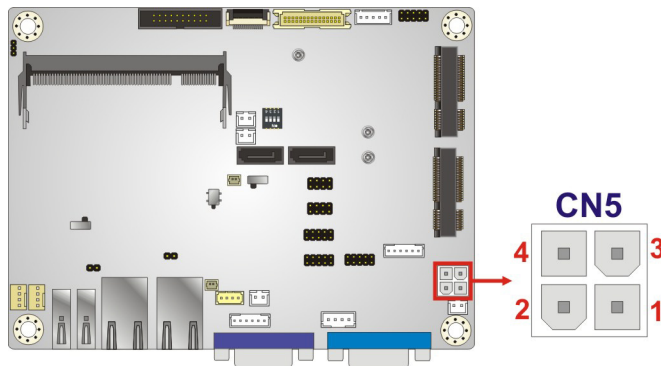

Figure 3-2: +12V DC-IN Power Connector Location

PIN NO.	DESCRIPTION	PIN NO.	DESCRIPTION
1	GND	2	GND
3	+12V	4	+12V

Table 3-3: +12V DC-IN Power Connector Pinouts

3.2.2 Audio Connector

- CN Label: **AUDIO1**
- CN Type: 10-pin header, p=2.00 mm
- CN Location: See **Figure 3-3**
- CN Pinouts: See **Table 3-4**

The audio connector is connected to external audio devices including speakers and microphones for the input and output of audio signals to and from the system.

WAFER-BT

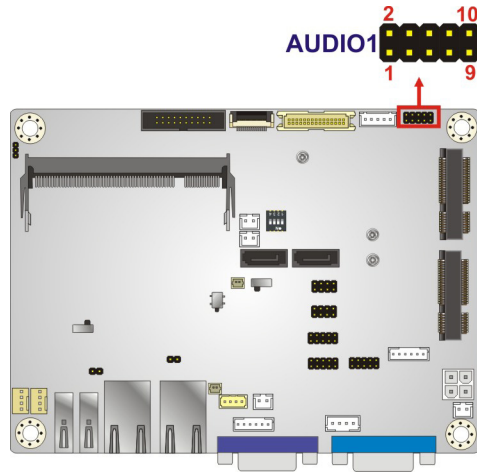

Figure 3-3: Audio Connector Location

PIN NO.	DESCRIPTION	PIN NO.	DESCRIPTION
1	LINE_OUTR	2	LINEIN_R
3	Analog_GND	4	Analog_GND
5	LINE_OUTL	6	LINEIN_L
7	Analog_GND	8	Analog_GND
9	LMIC1-R	10	LMIC1-L

Table 3-4: Audio Connector Pinouts

3.2.3 Battery Connector



NOTE:

It is recommended to attach the RTC battery onto the system chassis in which the WAFER-BT is installed.

- CN Label: **BAT1**
- CN Type: 2-pin wafer, p=1.25 mm
- CN Location: See **Figure 3-4**
- CN Pinouts: See **Table 3-5**

The battery connector is connected to the system battery. The battery provides power to the system clock to retain the time when power is turned off.

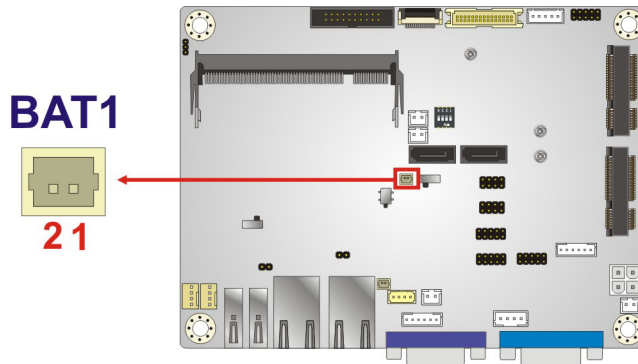

Figure 3-4: Battery Connector Location

PIN NO.	DESCRIPTION	PIN NO.	DESCRIPTION
1	VBATT	2	GND

Table 3-5: Battery Connector Pinouts

3.2.4 Buzzer Connector



NOTE :

If you cannot find a good place to put a buzzer on the WAFER-BT, it is recommended to attach the buzzer onto the system chassis in which the WAFER-BT is installed.

- CN Label: **SP1**
- CN Type: 2-pin wafer, p=1.25 mm
- CN Location: See **Figure 3-5**
- CN Pinouts: See **Table 3-6**

The buzzer connector is connected to the buzzer.

WAFER-BT

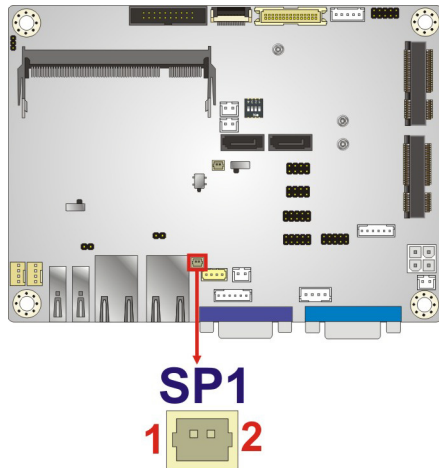

Figure 3-5: Buzzer Connector Location

PIN NO.	DESCRIPTION	PIN NO.	DESCRIPTION
1	Buzzer +	2	Buzzer -

Table 3-6: Buzzer Connector Pinouts

3.2.5 Fan Connectors

CN Label: CPU_FAN1, SYS_FAN1

CN Type: 4-pin wafer, p=2.54 mm

CN Location: See **Figure 3-6**

CN Pinouts: See **Table 3-7**

The fan connector attaches to a cooling fan.

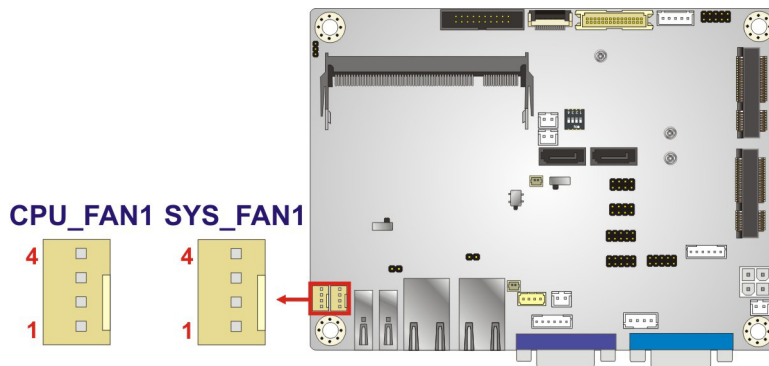

Figure 3-6: Fan Connector Locations

PIN NO.	DESCRIPTION	PIN NO.	DESCRIPTION
1	GND	2	+12V
3	FANIO1	4	FANOUT1

Table 3-7: Fan Connector Pinouts

3.2.6 DDR3L SO-DIMM Slot

- CN Label: DIMM1
- CN Type: DDR3L SO-DIMM slot
- CN Location: See **Figure 3-7**

The DDR3L SO-DIMM slot is for DDR3L SO-DIMM memory module.

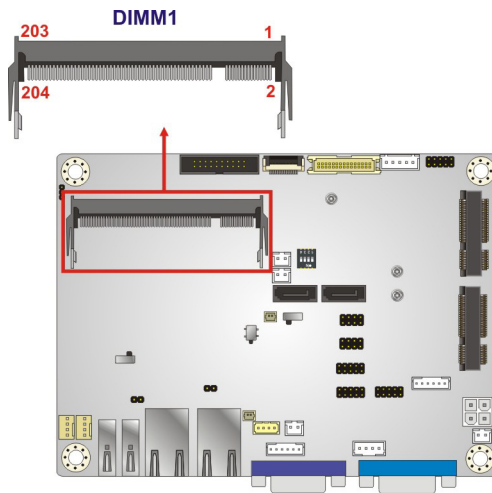

Figure 3-7: DDR3L SO-DIMM Slot Location

3.2.7 Digital I/O Connector

- CN Label: DIO1
- CN Type: 10-pin header, p=2.00 mm
- CN Location: See **Figure 3-8**
- CN Pinouts: See **Table 3-8**

WAFER-BT

The digital I/O connector provides programmable input and output for external devices. The digital I/O provides 4-bit output and 4-bit input.

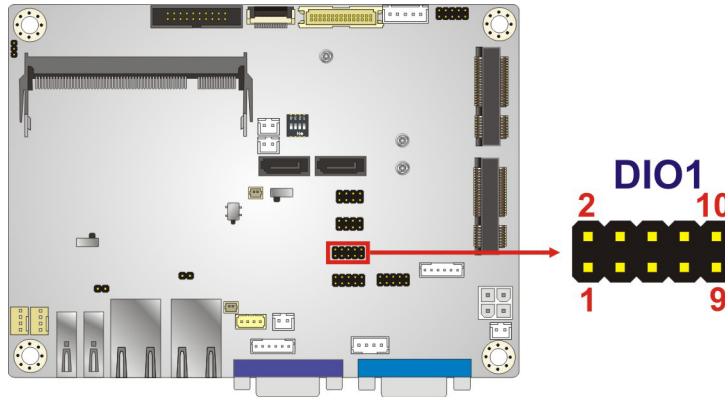

Figure 3-8: Digital I/O Connector Location

PIN NO.	DESCRIPTION	PIN NO.	DESCRIPTION
1	GND	2	+5V
3	DGPO3	4	DGPO2
5	DGPO1	6	DGPO0
7	DGPI3	8	DGPI2
9	DGPI1	10	DGPI0

Table 3-8: Digital I/O Connector Pinouts

3.2.8 Display Port Connector

- CN Label: DP 1
- CN Type: 20-pin box header, $p=2.00$ mm
- CN Location: See **Figure 3-9**
- CN Pinouts: See **Table 3-9**

The disport port connector provides flexible display function that supports VGA, DVI, LVDS, HDMI and DisplayPort via the disport port convert board.

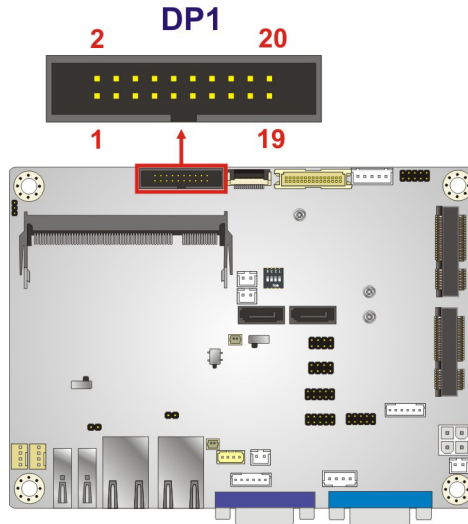

Figure 3-9: Display Port Connector Location

Pin	Description	Pin	Description
1	+5V	2	DPD_OB_LANE1_N
3	DPD_OB_LANE1_P	4	GND
5	DPD_OB_LANE3_N	6	DPD_OB_LANE3_P
7	GND	8	AUX_CTRL_DET_D
9	GND	10	DDI1_HPD#
11	DPD_AUX_CTRL_P2	12	DPD_AUX_CTRL_N2
13	GND	14	DPD_OB_LANE2_P
15	DPD_OB_LANE2_N	16	GND
17	DPD_OB_LANE0_P	18	DPD_OB_LANE0_N
19	+3.3V	20	NC

Table 3-9: Display Port Connector Pinouts

3.2.9 Front Panel Connector

- CN Label: CN4
- CN Type: 6-pin wafer, p=2.00 mm
- CN Location: See **Figure 3-10**
- CN Pinouts: See **Table 3-10**

The front panel connector connects to the indicator LEDs on the system front panel.

WAFER-BT

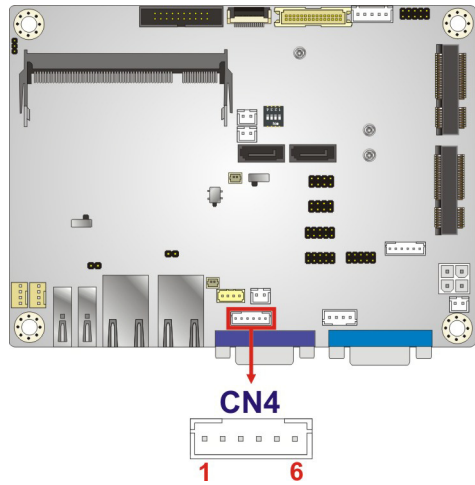

Figure 3-10: Front Panel Connector Location

PIN NO.	DESCRIPTION	PIN NO.	DESCRIPTION
1	+5V	2	GND
3	PWR_LED+	4	PWR_LED-
5	HDD_LED+	6	HDD_LED-

Table 3-10: Front Panel Connector Pinouts

3.2.10 Keyboard and Mouse Connector

CN Label: KB_MS 1

CN Type: 6-pin wafer, p=2.00 mm

CN Location: See **Figure 3-11**

CN Pinouts: See **Table 3-11**

The keyboard/mouse connector connects to a PS/2 Y-cable that can be connected to a PS/2 keyboard and mouse.

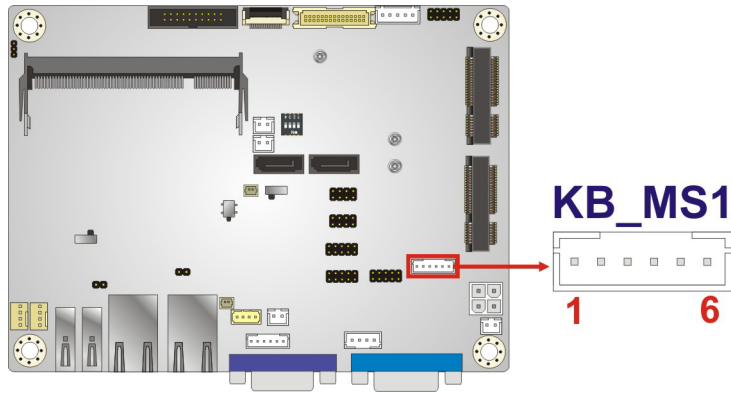

Figure 3-11: Keyboard and Mouse Location

Pin	Description
1	VCC
2	Mouse Data
3	Mouse Clock
4	Keyboard Data
5	Keyboard Clock
6	GND

Table 3-11: Keyboard and Mouse Connector Pinouts

3.2.11 LVDS Backlight Inverter Connector

- CN Label: INV1
- CN Type: 5-pin wafer, p=2.00 mm
- CN Location: See **Figure 3-12**
- CN Pinouts: See **Table 3-12**

The backlight inverter connector provides power to an LCD panel.

WAFER-BT

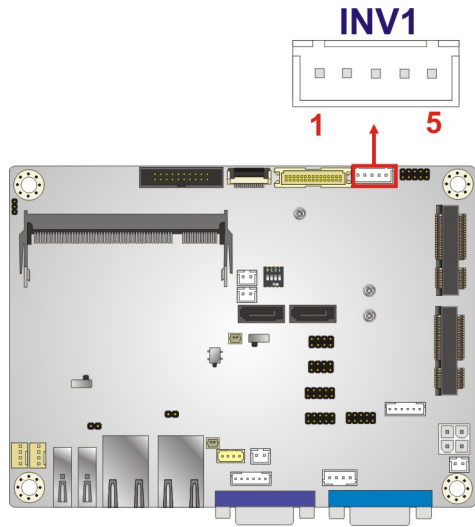

Figure 3-12: Backlight Inverter Connector Location

Pin	Description
1	BRIGHTNESS2
2	GND
3	12V
4	GND
5	ENABKL2

Table 3-12: Backlight Inverter Connector Pinouts

3.2.12 LVDS LCD Connector

- CN Label: LVDS 1
- CN Type: 30-pin crimp, p=1.25 mm
- CN Location: See **Figure 3-13**
- CN Pinouts: See **Table 3-13**

The LVDS connector is for an LCD panel connected to the board.

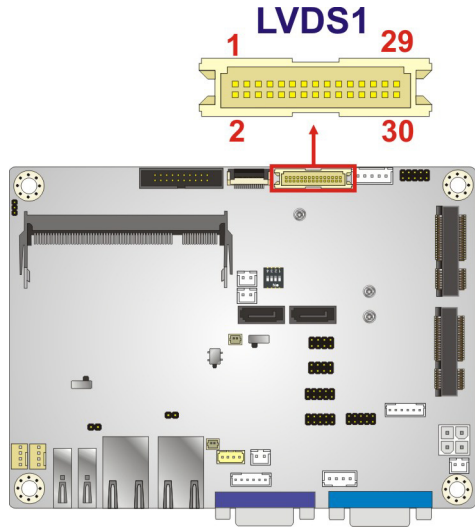

Figure 3-13: LVDS Connector Location

Pin	Description	Pin	Description
1	GROUND	2	GROUND
3	LVDS_A_TX0-P	4	LVDS_A_TX0-N
5	LVDS_A_TX1-P	6	LVDS_A_TX1-N
7	LVDS_A_TX2-P	8	LVDS_A_TX2-N
9	LVDS_A_TXCLK-P	10	LVDS_A_TXCLK-N
11	LVDS_A_TX3-P	12	LVDS_A_TX3-N
13	GROUND	14	GROUND
15	LVDS_B_TX0-P	16	LVDS_B_TX0-N
17	LVDS_B_TX1-P	18	LVDS_B_TX1-N
19	LVDS_B_TX2-P	20	LVDS_B_TX2-N
21	LVDS_B_TXCLK-P	22	LVDS_B_TXCLK-N
23	LVDS_B_TX3-P	24	LVDS_B_TX3-N
25	GROUND	26	GROUND
27	+LCD VCC	28	+LCD VCC
29	+LCD VCC	30	+LCD VCC

Table 3-13: LVDS Connector Pinouts

WAFER-BT

3.2.13 LAN LED Connector

- CN Label: JP2, JP3
- CN Type: 2-pin header, p=2.00 mm
- CN Location: See **Figure 3-14**
- CN Pinouts: See **Table 3-14**

The LAN LED connectors connect to the LAN link LEDs on the system.

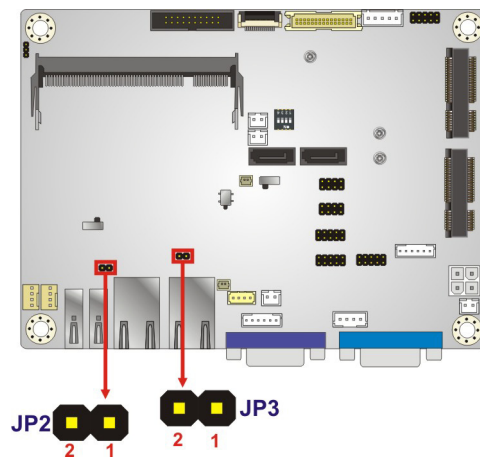

Figure 3-14: LAN LED Connector Location

PIN NO.	DESCRIPTION	PIN NO.	DESCRIPTION
1	+3.3VLAN	2	LAN_LED_LINK#

Table 3-14: LAN LED Connector Pinouts

3.2.14 PCIe Mini Card Slot

- CN Label: CN1
- CN Type: PCIe Mini card slot
- CN Location: See **Figure 3-15**

The PCIe Mini card slot is for installing a PCIe Mini expansion card or an mSATA module.

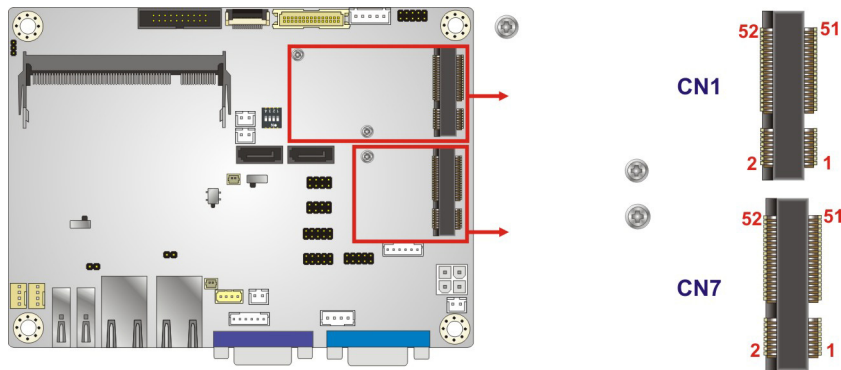

Figure 3-15: PCIe Mini Card Slot Location



NOTE:

If an mSATA module is installed in the PCIe Mini slot (CN1), the SATA port 2 (SATA2) will be disabled. Choose either the SATA2 connector or the mSATA module for storage.

3.2.15 Power Button Connector

- CN Label: PWR_BTN1
- CN Type: 2-pin wafer, p=2.00 mm
- CN Location: See **Figure 3-16**
- CN Pinouts: See **Table 3-15**

The power button connector is connected to a power switch on the system chassis to enable users to turn the system on and off.

WAFER-BT

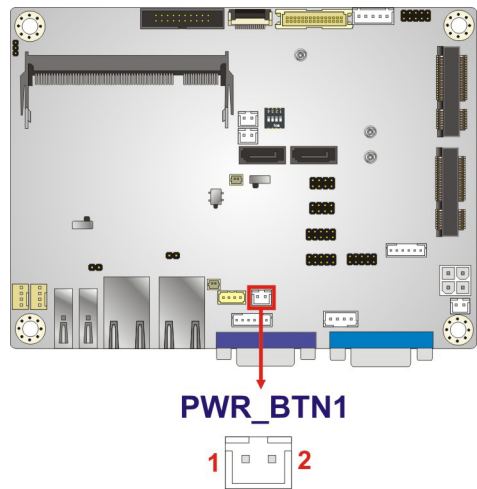

Figure 3-16: Power Button Connector Location

Pin	Description
1	PWRBTN_SW#
2	GND

Table 3-15: Power Button Connector Pinouts

3.2.16 Reset Button Connector

- CN Label: RST_BTN1
- CN Type: 2-pin wafer, p=2.00 mm
- CN Location: See **Figure 3-17**
- CN Pinouts: See **Table 3-16**

The reset button connector is connected to a reset switch on the system chassis to enable users to reboot the system when the system is turned on.

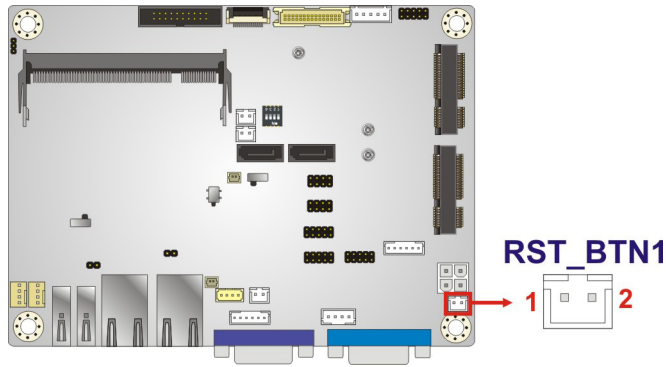

Figure 3-17: Reset Button Connector Location

Pin	Description
1	PM_SYSRST_R#
2	GND

Table 3-16: Reset Button Connector Pinouts

3.2.17 RS-232 Serial Port Connectors

- CN Label: COM2, COM3
- CN Type: 10-pin header, p=2.00 mm
- CN Location: See **Figure 3-18**
- CN Pinouts: See **Table 3-17**

The serial connector provides RS-232 connection.

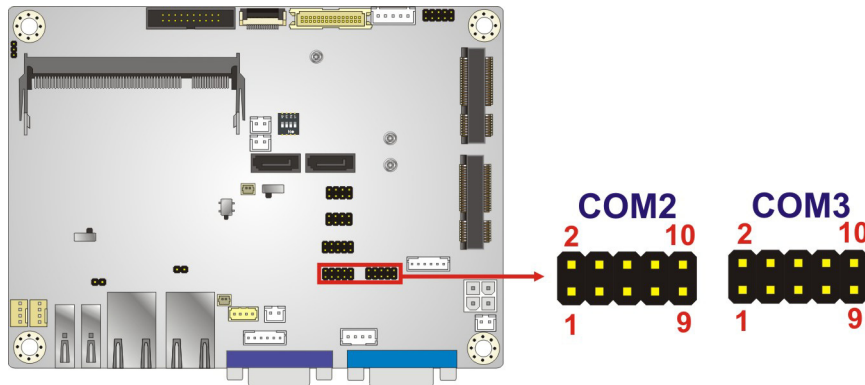

Figure 3-18: RS-232 Serial Port Connectors Locations

WAFER-BT

PIN NO.	DESCRIPTION	PIN NO.	DESCRIPTION
1	DCD	2	DSR
3	RXD	4	RTS
5	TXD	6	CTS
7	DTR	8	RI
9	GND	10	GND

Table 3-17: RS-232 Serial Port Connector Pinouts

3.2.18 RS-422/485 Serial Port Connector

- CN Label: COM4
- CN Type: 4-pin wafer, p=2.00 mm
- CN Location: See **Figure 3-19**
- CN Pinouts: See **Table 3-18**

This connector provides RS-422 or RS-485 communications.

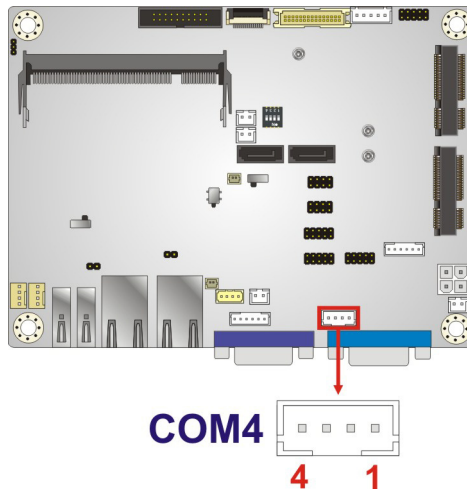

Figure 3-19: RS-422/485 Connector Location

Pin	Description	Pin	Description
1	RXD422-	2	RXD422+
3	TXD422+/TXD485+	4	TXD422-/TXD485-

Table 3-18: RS-422/485 Connector Pinouts

Use the optional RS-422/485 cable to connect to a serial device. The pinouts of the DB-9 connector are listed below.

RS-422 Pinouts	RS-485 Pinouts

Table 3-19: DB-9 RS-422/485 Pinouts

3.2.19 SATA 3Gb/s Drive Connectors

- CN Label: **SATA1, SATA2**
- CN Type: 7-pin SATA connector
- CN Location: See **Figure 3-20**

The SATA 3Gb/s drive connector is connected to a SATA 3Gb/s drive. The SATA 3Gb/s drive transfers data at speeds as high as 3Gb/s.

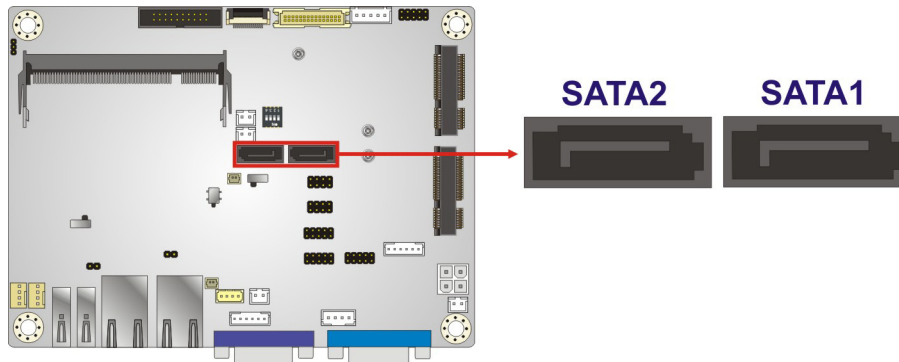

Figure 3-20: SATA 3Gb/s Drive Connectors Locations

WAFER-BT



NOTE:

If an HDD is connected to the SATA port 2 (SATA2), an mSATA module will not be supported by the PCIe Mini slot (CN1). Choose either the SATA2 connector or the mSATA module for storage.

3.2.20 SATA Power Connectors

CN Label: **SATA_PWR1, SATA_PWR2**

CN Type: 2-pin wafer, p=2.00 mm

CN Location: See **Figure 3-21**

CN Pinouts: See **Table 3-20**

The SATA power connector provides +5V power output to the SATA connector.

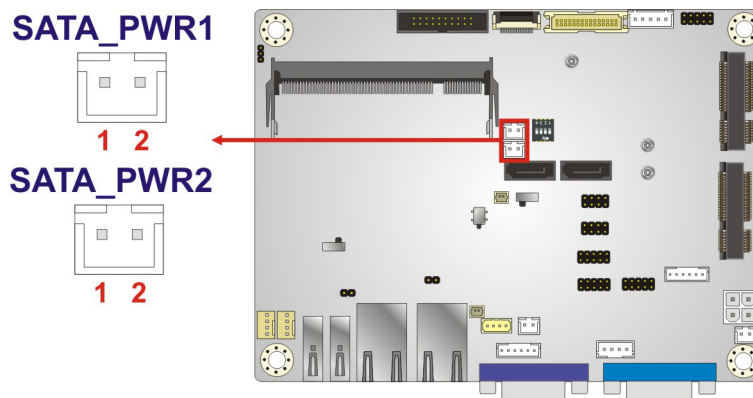

Figure 3-21: SATA Power Connector Locations

PIN NO.	DESCRIPTION
1	+5V
2	GND

Table 3-20: SATA Power Connector Pinouts

3.2.21 SMBus Connector

- CN Label: CN2
- CN Type: 4-pin wafer, p=1.25 mm
- CN Location: See **Figure 3-22**
- CN Pinouts: See **Table 3-21**

The SMBus (System Management Bus) connector provides low-speed system management communications.

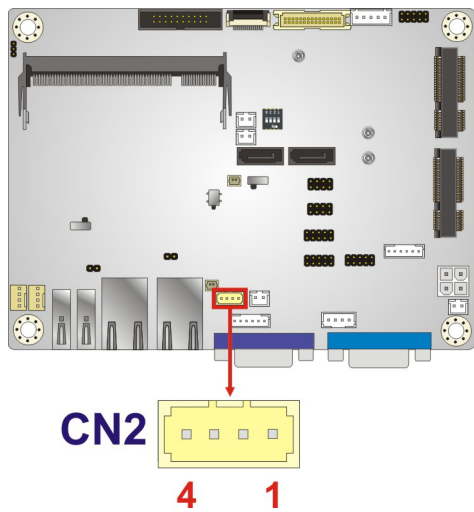

Figure 3-22: SMBus Connectors Location

PIN NO.	DESCRIPTION	PIN NO.	DESCRIPTION
1	GND	2	SMBDATA
3	SMBCLK	4	+5V

Table 3-21: SMBus Connectors Pinouts

3.2.22 USB Connectors

- CN Label: **USB1, USB4**
- CN Type: 8-pin header, p=2.00 mm
- CN Location: See **Figure 3-23**
- CN Pinouts: See **Table 3-22**

WAFER-BT

The USB connectors provide four USB 2.0 ports by dual-port USB cable.

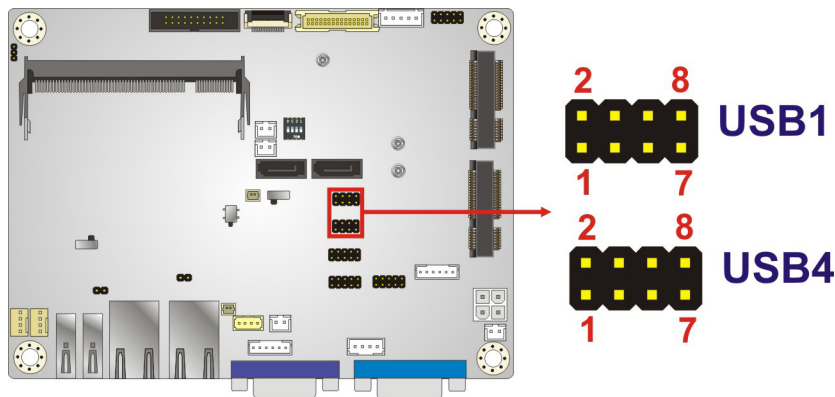

Figure 3-23: USB Connectors Locations

PIN NO.	DESCRIPTION	PIN NO.	DESCRIPTION
1	+5V	2	GND
3	-DATA_USB1/3	4	+DATA_USB2/4
5	+DATA_USB1/3	6	-DATA_USB2/4
7	GND	8	+5V

Table 3-22: USB Connectors Pinouts

3.3 External Peripheral Interface Connector Panel

Figure 3-24 shows the WAFER-BT external peripheral interface connector (EPIC) panel.

The EPIC panel consists of the following:

- 2 x LAN connectors
- 1 x USB 3.0 connector
- 1 x USB 2.0 connector
- 1 x RS-232 serial port connector
- 1 x VGA connector

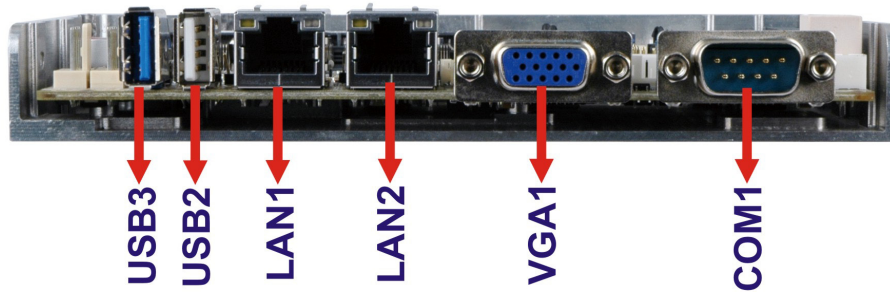

Figure 3-24: External Peripheral Interface Connector

3.3.1 LAN Connector

- CN Label: LAN1, LAN2
- CN Type: RJ-45
- CN Location: See **Figure 3-24**
- CN Pinouts: See **Figure 3-25** and **Table 3-23**

The LAN connector connects to a local network.

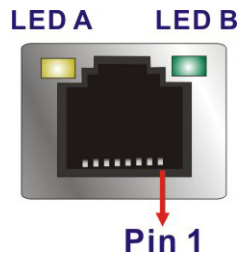

Figure 3-25: LAN Connector

Pin	Description	Pin	Description
1	MDIA3-	5	MDIA2+
2	MDIA3+	6	MDIA1+
3	MDIA1-	7	MDIA0-
4	MDIA2-	8	MDIA0+

Table 3-23: LAN Pinouts

WAFER-BT

LED	Description	LED	Description
A	on: linked blinking: data is being sent/received	B	off: 10 Mb/s green: 100 Mb/s orange: 1000 Mb/s

Table 3-24: Connector LEDs

3.3.2 USB Connectors

CN Label:	USB 2, USB 3
CN Type:	USB 2.0 & USB 3.0 ports
CN Location:	See Figure 3-24
CN Pinouts:	See Table 3-26

The WAFER-BT has one external USB 2.0 port and one external USB 3.0 port. The USB connector can be connected to a USB device. The pinouts of USB 2.0 port & USB 3.0 connectors are shown below.

PIN NO.	DESCRIPTION	PIN NO.	DESCRIPTION
1	+5V	2	-DATA_USB3
3	-DATA_USB4	4	GND

Table 3-25: USB 2.0 Port Pinouts

PIN NO.	DESCRIPTION	PIN NO.	DESCRIPTION
1	+5V	2	USB2P0-
3	USB2P0+	4	GND
5	USB3P0_RXDN1	6	USB3P0_RXDP1
7	GND	8	USB3P0_TXDN1
9	USB3P0_TXDP1		

Table 3-26: USB 3.0 Port Pinouts

3.3.3 RS-232 Serial Port Connector

- CN Label:** COM1
- CN Type:** DB-9 Male
- CN Location:** See **Figure 3-24**
- CN Pinouts:** See **Figure 3-26** and **Table 3-27**

The serial port connects to a RS-232 serial communications device.

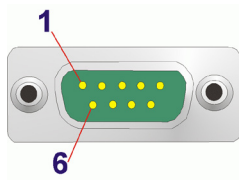

Figure 3-26: RS-232 Serial Port Connector

PIN NO.	DESCRIPTION	PIN NO.	DESCRIPTION
1	DCD1	6	DSR1
2	RX1	7	RTS1
3	TX1	8	CTS1
4	DTR1	9	RI1
5	GND		

Table 3-27: RS-232 Serial Port Connector Pinouts

3.3.4 VGA Connector

- CN Label:** VGA1
- CN Type:** 15-pin female (VGA)
- CN Location:** See **Figure 3-24**
- CN Pinouts:** See **Figure 3-27** and **Table 3-28**

The VGA port connects to a monitor that accepts a standard VGA input.

WAFER-BT

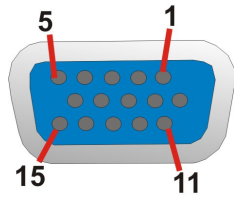

Figure 3-27: VGA Connector

PIN	DESCRIPTION	PIN	DESCRIPTION
1	Red	2	Green
3	Blue	4	NC
5	GND	6	GND
7	GND	8	GND
9	VGAVCC	10	HOTPLUG
11	NC	12	DCCDAT
13	HSYNC	14	VSYNC
15	DDCCLK		

Table 3-28: VGA Connector Pinouts

Chapter

4

Installation

WAFER-BT

4.1 Anti-static Precautions



WARNING:

Failure to take ESD precautions during the installation of the WAFER-BT may result in permanent damage to the WAFER-BT and severe injury to the user.

Electrostatic discharge (ESD) can cause serious damage to electronic components, including the WAFER-BT. Dry climates are especially susceptible to ESD. It is therefore critical that whenever the WAFER-BT or any other electrical component is handled, the following anti-static precautions are strictly adhered to.

- **Wear an anti-static wristband:** Wearing a simple anti-static wristband can help to prevent ESD from damaging the board.
- **Self-grounding:** Before handling the board, touch any grounded conducting material. During the time the board is handled, frequently touch any conducting materials that are connected to the ground.
- **Use an anti-static pad:** When configuring the WAFER-BT, place it on an anti-static pad. This reduces the possibility of ESD damaging the WAFER-BT.
- **Only handle the edges of the PCB:** When handling the PCB, hold the PCB by the edges.

4.2 Installation Considerations



NOTE:

The following installation notices and installation considerations should be read and understood before installation. All installation notices must be strictly adhered to. Failing to adhere to these precautions may lead to severe damage and injury to the person performing the installation.

**WARNING:**

The installation instructions described in this manual should be carefully followed in order to prevent damage to the WAFER-BT, WAFER-BT components and injury to the user.

Before and during the installation please **DO** the following:

- Read the user manual:
 - The user manual provides a complete description of the WAFER-BT installation instructions and configuration options.
- Wear an electrostatic discharge cuff (ESD):
 - Electronic components are easily damaged by ESD. Wearing an ESD cuff removes ESD from the body and helps prevent ESD damage.
- Place the WAFER-BT on an antistatic pad:
 - When installing or configuring the motherboard, place it on an antistatic pad. This helps to prevent potential ESD damage.
- Turn all power to the WAFER-BT off:
 - When working with the WAFER-BT, make sure that it is disconnected from all power supplies and that no electricity is being fed into the system.

Before and during the installation of the WAFER-BT **DO NOT:**

- Remove any of the stickers on the PCB board. These stickers are required for warranty validation.
- Use the product before verifying all the cables and power connectors are properly connected.
- Allow screws to come in contact with the PCB circuit, connector pins, or its components.

WAFER-BT

4.3 SO-DIMM Installation

**WARNING:**

Using incorrectly specified SO-DIMM may cause permanently damage the WAFER-BT. Please make sure the purchased SO-DIMM complies with the memory specifications of the WAFER-BT. SO-DIMM specifications compliant with the WAFER-BT are listed in the specification table of Chapter 1.

To install an SO-DIMM, please follow the steps below and refer to Figure 4-1.

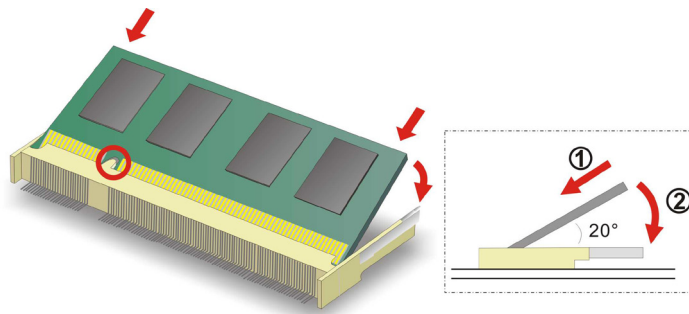

Figure 4-1: SO-DIMM Installation

- Step 1:** **Locate the SO-DIMM socket.** Place the board on an anti-static mat.
- Step 2:** **Align the SO-DIMM with the socket.** Align the notch on the memory with the notch on the memory socket.
- Step 3:** **Insert the SO-DIMM.** Push the memory in at a 20° angle. (See Figure 4-1)
- Step 4:** **Seat the SO-DIMM.** Gently push downwards and the arms clip into place. (See Figure 4-1)

4.4 Full-size PCIe Mini Card Installation

To install a full-size PCIe Mini card, please follow the steps below.

Step 1: Locate the PCIe Mini card slot. See **Figure 3-15**.

Step 2: Remove the retention screw. Remove the retention screw as shown in **Figure 4-2**.

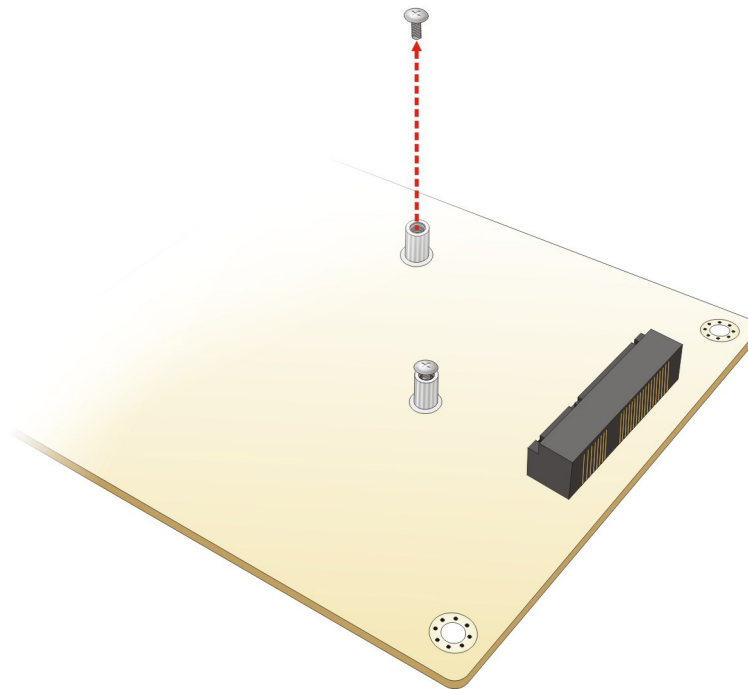

Figure 4-2: Removing the Retention Screw

Step 3: Remove the retention screw and standoff. Unscrew and remove the retention screw and standoff for half-size PCIe Mini card secured on the motherboard as shown in **Figure 4-3**.

WAFER-BT

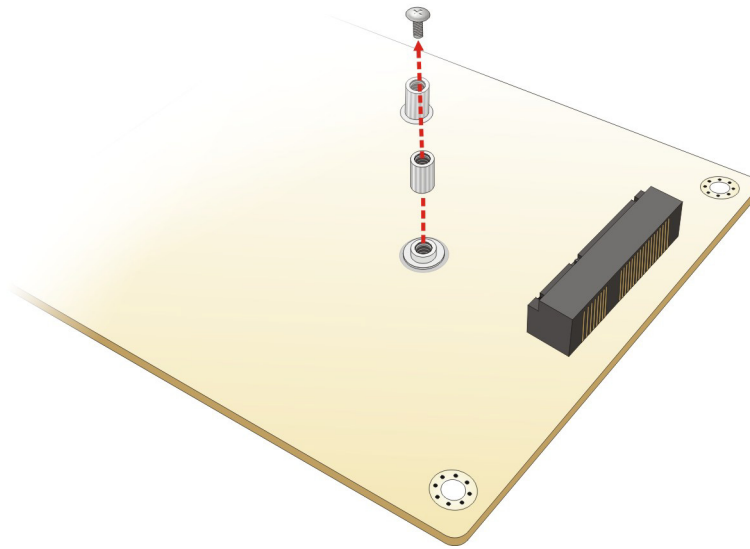

Figure 4-3: Removing the Retention Screw and Standoff

Step 4: **Insert into the socket at an angle.** Line up the notch on the card with the notch on the slot. Slide the PCIe Mini card into the socket at an angle of about 20° (Figure 4-4).

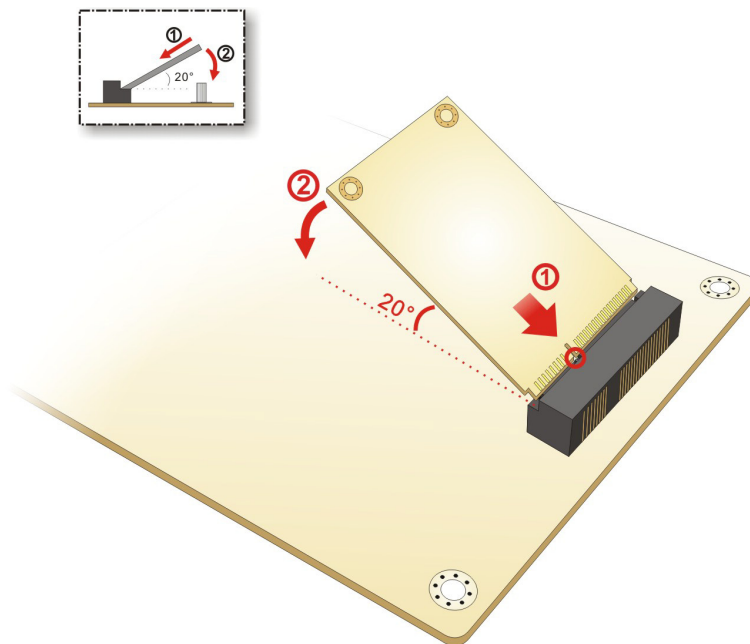

Figure 4-4: Inserting the Full-size PCIe Mini Card into the Slot at an Angle

Step 5: **Secure the full-size PCIe Mini card.** Secure the full-size PCIe Mini card with the retention screw previously removed (**Figure 4-5**).

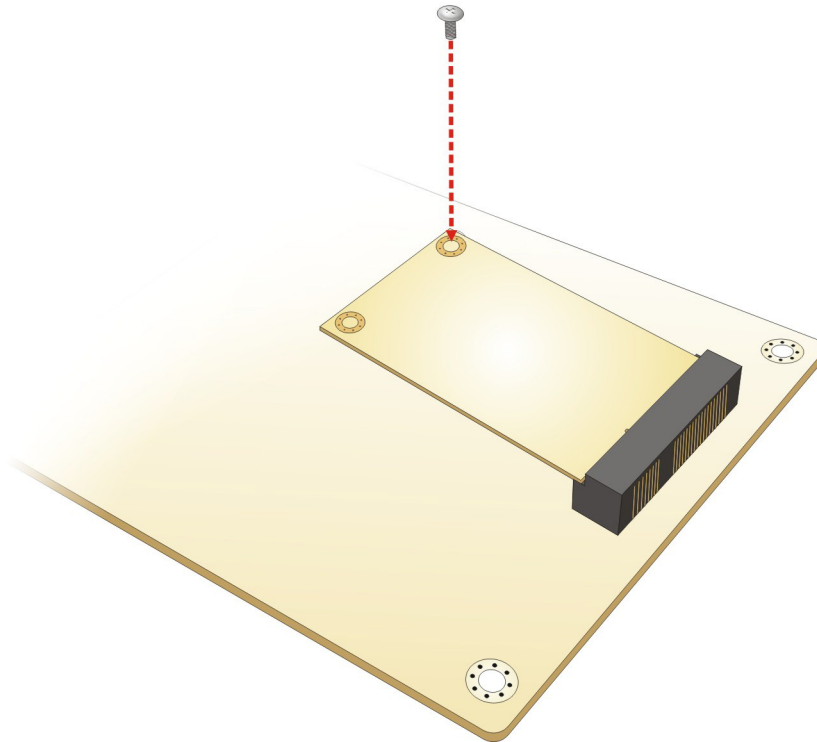

Figure 4-5: Securing the Full-size PCIe Mini Card



NOTE:

If an mSATA module is installed in the PCIe Mini slot (CN1), the SATA port 2 (SATA2) will be disabled. Choose either the SATA2 connector or the mSATA module for storage.

WAFER-BT**4.5 Half-size PCIe Mini Card Installation**

To install a half-size PCIe Mini card, please follow the steps below.

Step 1: Locate the PCIe Mini card slot. See **Figure 3-15**.

Step 2: Remove the retention screw. Remove the retention screw as shown in **Figure 4-6**.

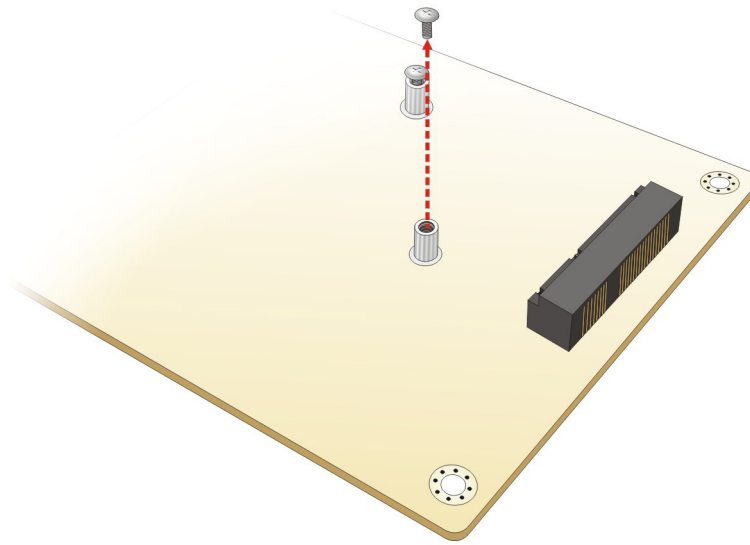

Figure 4-6: Removing the Retention Screw

Step 3: Insert into the socket at an angle. Line up the notch on the card with the notch on the slot. Slide the PCIe Mini card into the socket at an angle of about 20° (**Figure 4-7**).

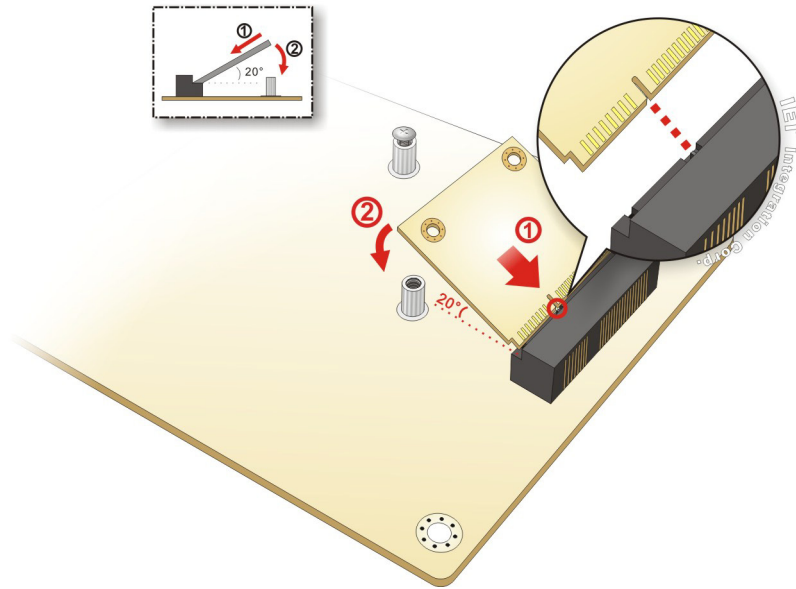

Figure 4-7: Inserting the Half-size PCIe Mini Card into the Slot at an Angle

Step 4: **Secure the half-size PCIe Mini card.** Secure the full-size PCIe Mini card with the retention screw previously removed (**Figure 4-5**).

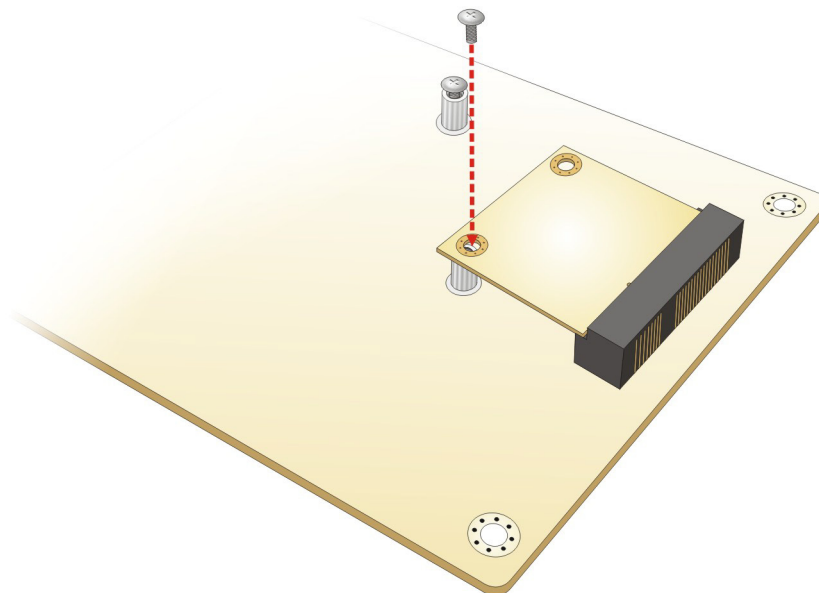

Figure 4-8: Securing the Half-size PCIe Mini Card

WAFER-BT

4.6 System Configuration

The system configuration is controlled by buttons, jumpers and switches. The system configuration should be performed before installation.

4.6.1 AT/ATX Mode Select Switch

CN Label:	J_ATX_AT1
CN Type:	switch
CN Location:	See Figure 4-9
CN Settings:	See Table 4-1

The AT/ATX mode select switch specifies the systems power mode as AT or ATX. AT/ATX mode select switch settings are shown in **Table 4-1**.

Setting	Description
Short A-B	ATX Mode (Default)
Short B-C	AT Mode

Table 4-1: AT/ATX Mode Select Switch Settings

The location of the AT/ATX mode select switch is shown in **Figure 4-9** below.

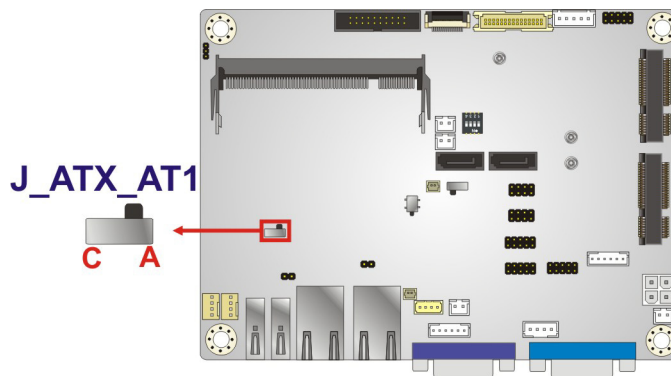

Figure 4-9: AT/ATX Mode Select Switch Location

4.6.2 Clear CMOS Button

- CN Label: J_CMOS 1
- CN Type: button
- CN Location: See **Figure 4-3**
- CN Settings: See **Table 4-2**

If the WAFER-BT fails to boot due to improper BIOS settings, use the button to clear the CMOS data and reset the system BIOS information.

The clear CMOS button settings are shown in **Table 4-2**.

Setting	Description	
Open	Normal Operation	Default
Push	Clear CMOS Setup	

Table 4-2: Clear CMOS Button Settings

The location of the clear CMOS button is shown in **Figure 4-3**

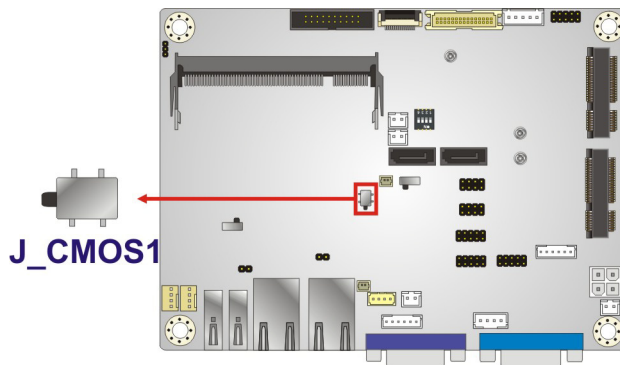

Figure 4-10: Clear CMOS Button Location

4.6.3 LVDS Panel Resolution Selection

- Jumper Label: SW 1
- Jumper Type: DIP switch
- Jumper Settings: See **Table 4-3**
- Jumper Location: See **Figure 4-11**

WAFER-BT

Selects the resolution of the LCD panel connected to the LVDS connector.

* ON=0, OFF=1; Single=S, Dual=D

SW1 (4-3-2-1)	Description
0000	800x600 18-bit S (default)
0001	1024x768 18-bit S
0010	1024x768 24-bit S
0011	1280x768 18-bit S
0100	1280x800 18-bit S
0101	1280x960 18-bit S
0110	1280x1024 24-bit D
0111	1366x768 18-bit S
1000	1366x768 24-bit S
1001	1440x960 24-bit D
1010	1400x1050 24-bit D
1011	1600x900 24-bit D
1100	1680x1050 24-bit D
1101	1600x1200 24-bit D
1110	1920x1080 24-bit D
1111	1920x1200 24-bit D

Table 4-3: LVDS Panel Resolution Selection

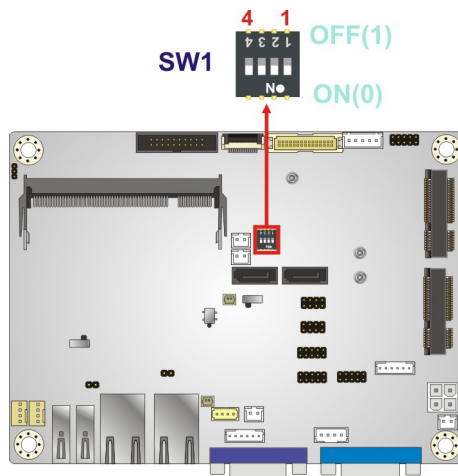

Figure 4-11: LVDS Panel Resolution Selection Switch Location

4.6.4 LVDS Voltage Selection



WARNING:

Permanent damage to the screen and WAFER-BT may occur if the wrong voltage is selected with this jumper. Please refer to the user guide that came with the monitor to select the correct voltage.

- Jumper Label: **J_LCD_PWR1**
- Jumper Type: switch
- Jumper Settings: See **Table 4-4**
- Jumper Location: See **Figure 4-12**

The LVDS voltage selection jumper allows setting the voltage provided to the monitor connected to the LVDS connector.

Setting	Description
Short A-B	+3.3V (Default)
Short B-C	+5V

Table 4-4: LVDS Voltage Selection Jumper Settings

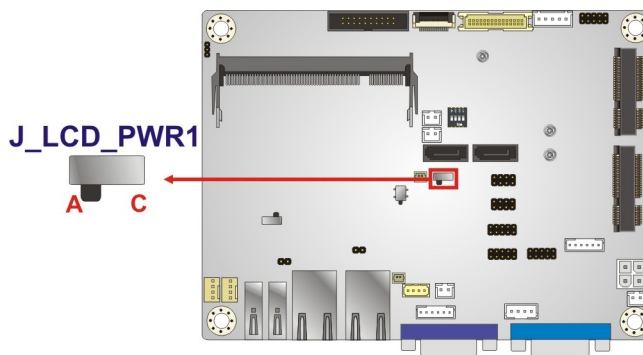

Figure 4-12: LVDS Voltage Selection Jumper Location

WAFER-BT

4.6.5 Flash Descriptor Security Override Jumper

- Jumper Label: J_FLASH1
- Jumper Type: 3-pin header
- Jumper Settings: See **Table 4-5**
- Jumper Location: See **Figure 4-13**

The Flash Descriptor Security Override jumper specifies whether to override the flash descriptor.

Setting	Description
Short 1-2	No override (Default)
Short 2-3	Override

Table 4-5: Flash Descriptor Security Override Jumper Settings

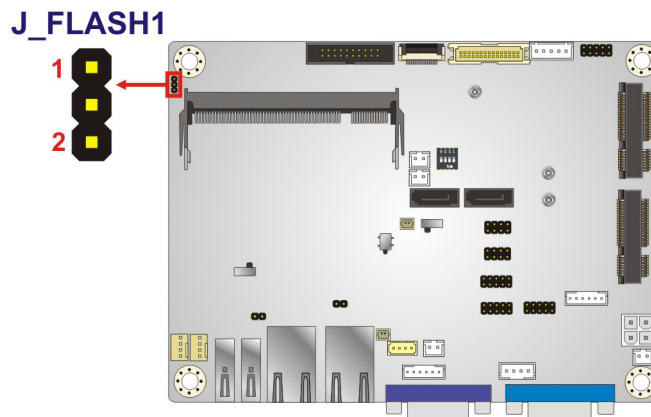

Figure 4-13: Flash Descriptor Security Override Jumper Location

4.7 Chassis Installation

4.7.1 Heat Sink Enclosure

**WARNING:**

Never run the WAFER-BT without the heat sink secured to the board. The heat sink ensures the system remains cool and does not need additional heat sinks to cool the system.

**WARNING:**

When running the WAFER-BT, do not put the WAFER-BT directly on a surface that can not dissipate system heat, especially the wooden or plastic surface. It is highly recommended to run the WAFER-BT

→ on a heat dissipation surface or

→ using copper pillars to hold the board up from the chassis

When the WAFER-BT is shipped, it is secured to a heat sink with four retention screws. If the WAFER-BT must be removed from the heat sink, the four retention screws must be removed.

4.7.2 Motherboard Installation

Each side of the heat sink enclosure has several screw holes allowing the WAFER-BT to be mounted into a chassis (please refer to Figure 1-3 for the detailed dimensions). The user can design or select a chassis that has screw holes matching up with the holes on the heat sink enclosure for installing the WAFER-BT. The following diagram shows an example of motherboard installation.

WAFER-BT

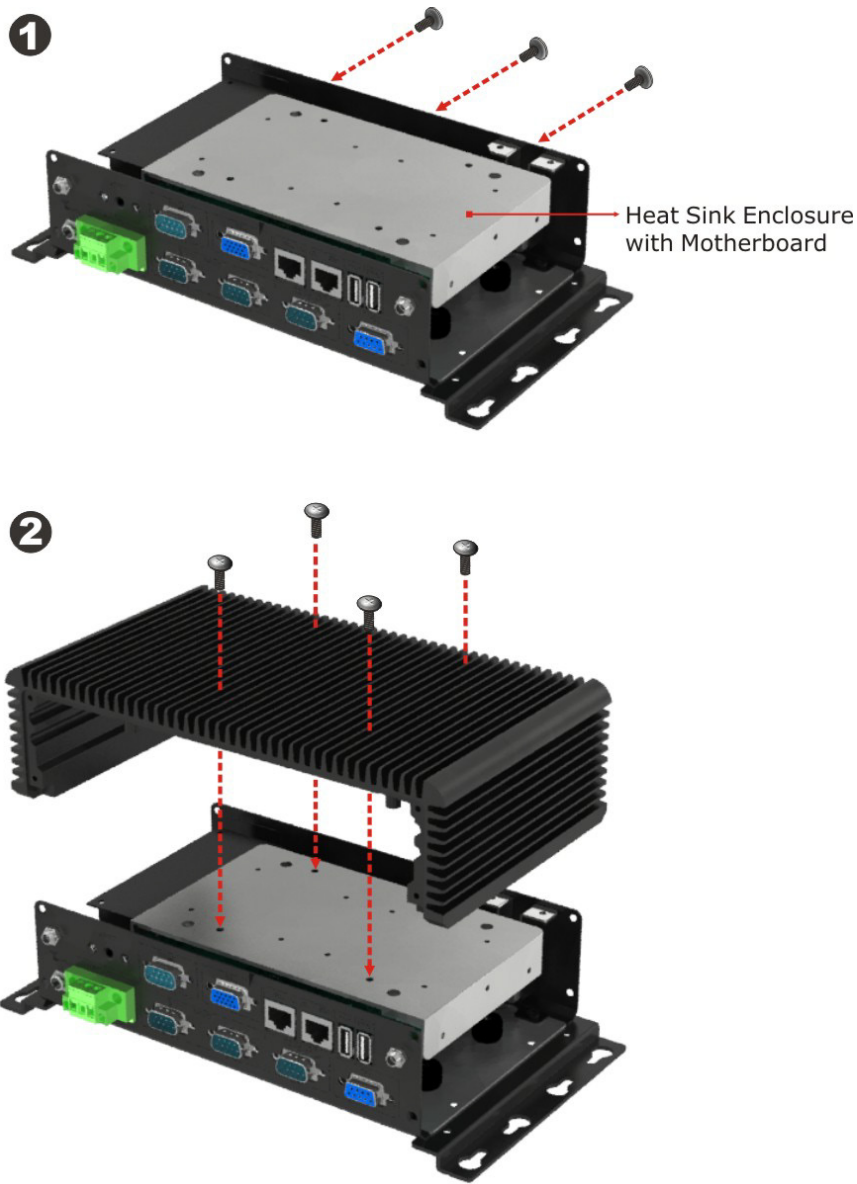

Figure 4-14: Motherboard Installation Example

4.8 Internal Peripheral Device Connections

This section outlines the installation of peripheral devices to the on-board connectors

4.8.1 Audio Kit Installation

The Audio Kit that came with the WAFER-BT connects to the audio connector on the WAFER-BT. The audio kit consists of three audio jacks. Mic-in connects to a microphone. Line-in provides a stereo line-level input to connect to the output of an audio device.

Line-out, a stereo line-level output, connects to two amplified speakers. To install the audio kit, please refer to the steps below:

Step 1: Locate the audio connector. The location of the 10-pin audio connector is shown in **Chapter 3**.

Step 2: Align pin 1. Align pin 1 on the on-board connector with pin 1 on the audio kit connector. Pin 1 on the audio kit connector is indicated with a white dot. See Figure 4-15.

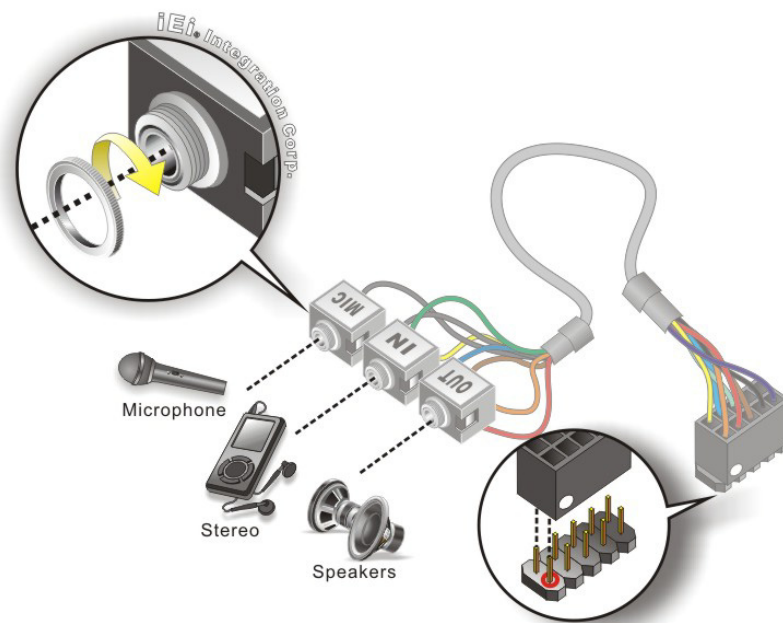

Figure 4-15: Audio Kit Cable Connection

Step 3: Connect the audio devices. Connect speakers to the line-out audio jack. Connect the output of an audio device to the line-in audio jack. Connect a microphone to the mic-in audio jack.

4.8.2 SATA Drive Connection

The WAFER-BT is shipped with a SATA drive cable. To connect the SATA drive to the connector, please follow the steps below.

WAFER-BT

- Step 1:** Locate the **SATA connector** and the **SATA power connector**. The locations of the connectors are shown in **Chapter 3**.
- Step 2:** **Insert the cable connector**. Insert the cable connector into the on-board SATA drive connector and the SATA power connector. See **Figure 4-16**.

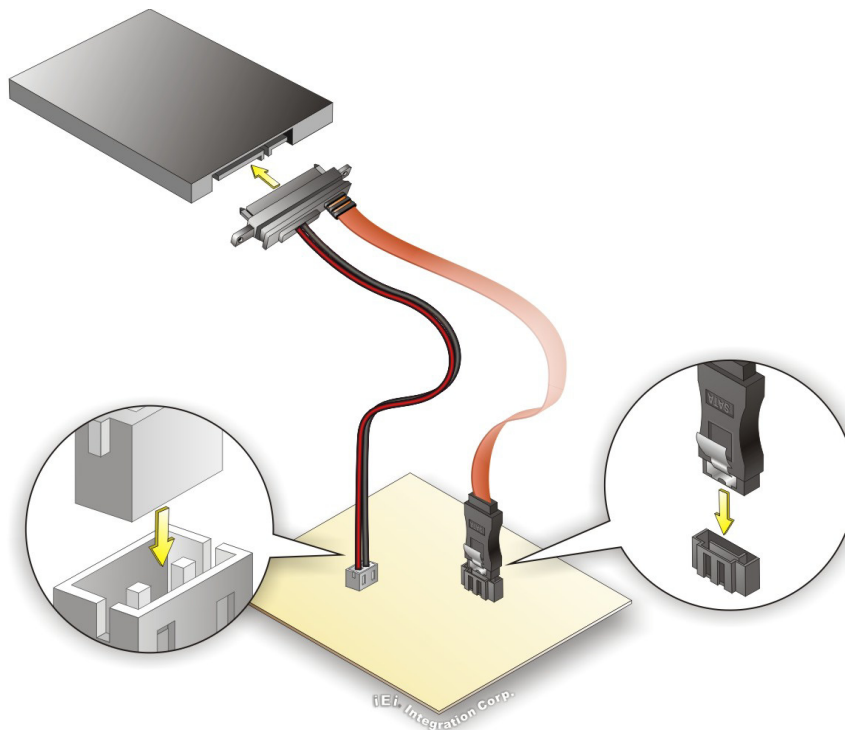

Figure 4-16: SATA Drive Cable Connection

- Step 3:** **Connect the cable to the SATA disk**. Connect the connector on the other end of the cable to the connector at the back of the SATA drive. See **Figure 4-16**.
- Step 4:** To remove the SATA cable from the SATA connector, press the clip on the connector at the end of the cable.

4.8.3 Single RS-232 Cable

The single RS-232 cable consists of one serial port connector attached to a serial communications cable that is then attached to a D-sub 9 male connector. To install the single RS-232 cable, please follow the steps below.

- Step 1: Locate the connector.** The location of the RS-232 connector is shown in **Chapter 3.**
- Step 2: Insert the cable connector.** Insert the connector into the serial port box header. See Figure 4-17. A key on the front of the cable connectors ensures the connector can only be installed in one direction.

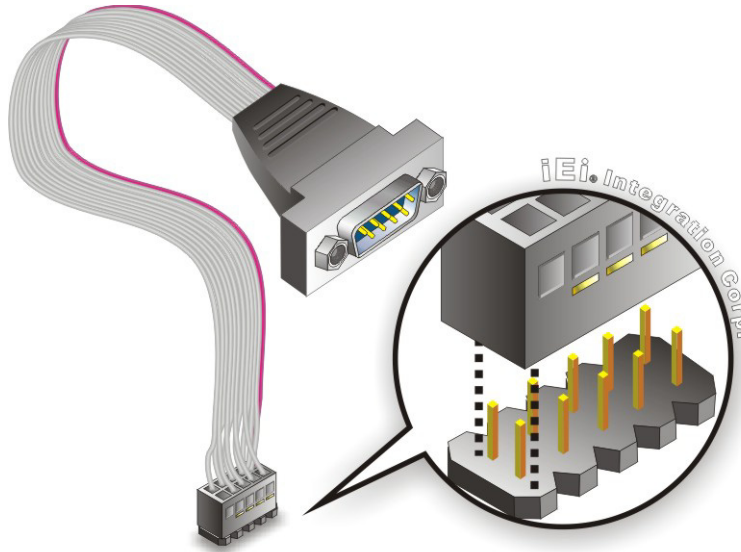

Figure 4-17: Single RS-232 Cable Installation

- Step 3: Secure the bracket.** The single RS-232 connector has two retention screws that must be secured to a chassis or bracket.
- Step 4: Connect the serial device.** Once the single RS-232 connector is connected to a chassis or bracket, a serial communications device can be connected to the system.

WAFER-BT

4.9 Driver Download

To download drivers from IEI Resource Download Center, follow the steps below.

Step 5: Go to <https://download.ieiworld.com>. Type WAFER-BT and press Enter.



Step 6: All product-related software, utilities, and documentation will be listed. You can choose **Driver** to filter the result.

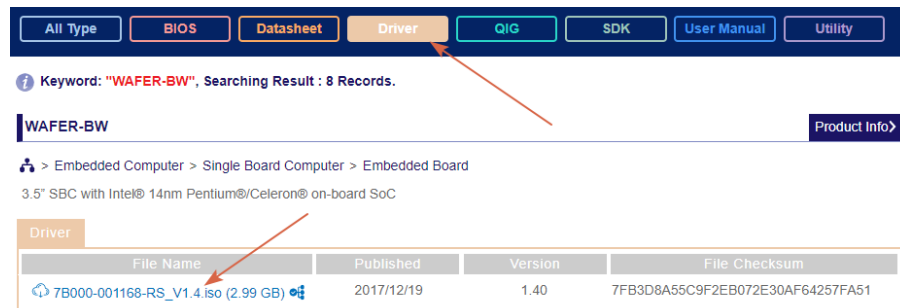

Step 7: Click the driver file name on the page and you will be prompted with the following window. You can download the entire ISO file (❶), or click the small arrow to find an individual driver and click the file name to download (❷).

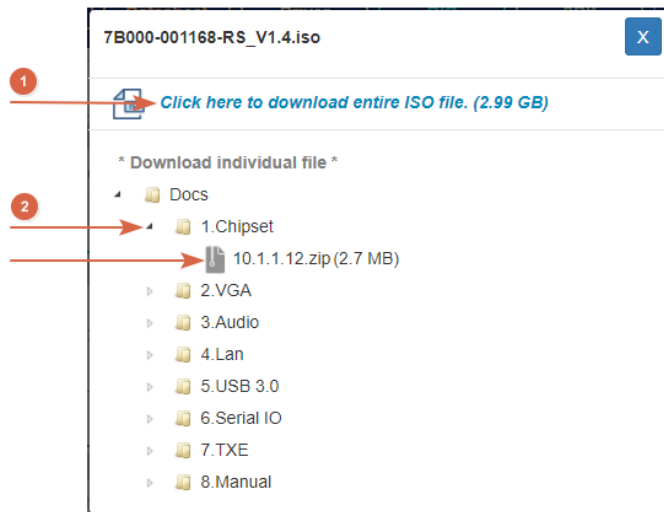

**NOTE:**

To install software from the downloaded ISO image file in Windows 8, 8.1 or 10, double-click the ISO file to mount it as a virtual drive to view its content. On Windows 7 system, an additional tool (such as Virtual CD-ROM Control Panel from Microsoft) is needed to mount the file.

Chapter

5

BIOS

5.1 Introduction

The BIOS is programmed onto the BIOS chip. The BIOS setup program allows changes to certain system settings. This chapter outlines the options that can be changed.



NOTE:

1. Some of the BIOS options may vary throughout the life cycle of the product and are subject to change without prior notice.
 2. To download the latest BIOS from IEI website, please find the correct version for the board:
 - SAA8AMxx.zip: for J19001 SKUs
-

5.1.1 Starting Setup

The UEFI BIOS is activated when the computer is turned on. The setup program can be activated in one of two ways.

1. Press the **DELETE** or **F2** key as soon as the system is turned on or
2. Press the **DELETE** or **F2** key when the “**Press Del to enter SETUP**” message appears on the screen.

If the message disappears before the **DELETE** or **F2** key is pressed, restart the computer and try again.

5.1.2 Using Setup

Use the arrow keys to highlight items, press **ENTER** to select, use the PageUp and PageDown keys to change entries, press **F1** for help and press **ESC** to quit. Navigation keys are shown in.

Key	Function
Up arrow	Move to previous item
Down arrow	Move to next item

WAFER-BT

Key	Function
Left arrow	Move to the item on the left hand side
Right arrow	Move to the item on the right hand side
+	Increase the numeric value or make changes
-	Decrease the numeric value or make changes
F1 key	General help, only for Status Page Setup Menu and Option Page Setup Menu
F2 key	Load previous values.
F3 key	Load optimized defaults
F4 key	Save changes and Exit BIOS
Esc key	Main Menu – Quit and not save changes into CMOS Status Page Setup Menu and Option Page Setup Menu -- Exit current page and return to Main Menu

Table 5-1: BIOS Navigation Keys

5.1.3 Getting Help

When **F1** is pressed a small help window describing the appropriate keys to use and the possible selections for the highlighted item appears. To exit the Help Window press **Esc** or the **F1** key again.

5.1.4 Unable to Reboot after Configuration Changes

If the computer cannot boot after changes to the system configuration is made, CMOS defaults. Use the jumper described in Chapter 3.

5.1.5 BIOS Menu Bar

The **menu bar** on top of the BIOS screen has the following main items:

- Main – Changes the basic system configuration.
- Advanced – Changes the advanced system settings.
- Chipset – Changes the chipset settings.
- Boot – Changes the system boot configuration.

- Security – Sets User and Supervisor Passwords.
- Save & Exit – Selects exit options and loads default settings

The following sections completely describe the configuration options found in the menu items at the top of the BIOS screen and listed above.

5.2 Main

The **Main** BIOS menu (**BIOS Menu 1**) appears when the **BIOS Setup** program is entered.

The **Main** menu gives an overview of the basic system information.

```

Aptio Setup Utility - Copyright (C) 2018 American Megatrends, Inc.
Main  Advanced  Chipset  Security  Boot  Save & Exit
-----
BIOS Information
BIOS Vendor                American Megatrends
Core Version                5.010
Compliancy                  UEFI 2.4; PI 1.3
Project Version             SAA8AM20.BIN
Build Date and Time         04/16/2018 10:40:35
iWDD Vendor                 iEi
iWDD Version                SAA8ER20.BIN

CPU Configuration
Microcode Patch             90a
BayTrail SoC                D0 Stepping

Memory Information
-----
Total Memory                4096 MB (LPDDR3)

TXE Information
Sec RC Version              00.05.00.00
TXE FW Version              01.01.05.1162

System Date                  [Fri 06/22/2018]
System Time                  [19:43:27]

Access Level                 Administrator

Set the Date. Use Tab to
switch between Data
elements.

-----
<->: Select Screen
^ v: Select Item
Enter>Select
+/-: Change Opt.
F1:  General Help
F2:  Previous Values
F3:  Optimized Defaults
F4:  Save & Exit
ESC: Exit

Version 2.18.1263. Copyright (C) 2018 American Megatrends, Inc.
    
```

BIOS Menu 1: Main

The Main menu lists the following system details:

- BIOS Information
- iWDD Information
- Memory Information
- TXE Information

WAFER-BT

The System Overview field also has two user configurable fields:

→ System Date [xx/xx/xx]

Use the **System Date** option to set the system date. Manually enter the day, month and year.

→ System Time [xx:xx:xx]

Use the **System Time** option to set the system time. Manually enter the hours, minutes and seconds.

5.3 Advanced

Use the **Advanced** menu (**BIOS Menu 2**) to configure the CPU and peripheral devices through the following sub-menus:



WARNING!

Setting the wrong values in the sections below may cause the system to malfunction. Make sure that the settings made are compatible with the hardware.

```

Aptio Setup Utility - Copyright (C) 2018 American Megatrends, Inc.
Main  Advanced  Chipset  Security  Boot  Save & Exit
-----
> ACPI Settings
> F81866 Super IO Configuration
> Hardware Monitor
> iWDD H/W Monitor
> RTC Wake Settings
> Serial Port Console Redirection
> iEi Feature
> CPU Configuration
> IDE Configuration
> USB Configuration

System ACPI Parameters.
-----
<=>: Select Screen
↑ ↓: Select Item
Enter>Select
F1  General Help
F2  Previous Values
F3  Optimized Defaults
F4  Save
ESC Exit

Version 2.18.1263. Copyright (C) 2018 American Megatrends, Inc.
    
```

BIOS Menu 2: Advanced

5.3.1 ACPI Settings

The **ACPI Settings** menu (**BIOS Menu 3**) configures the Advanced Configuration and Power Interface (ACPI) options.

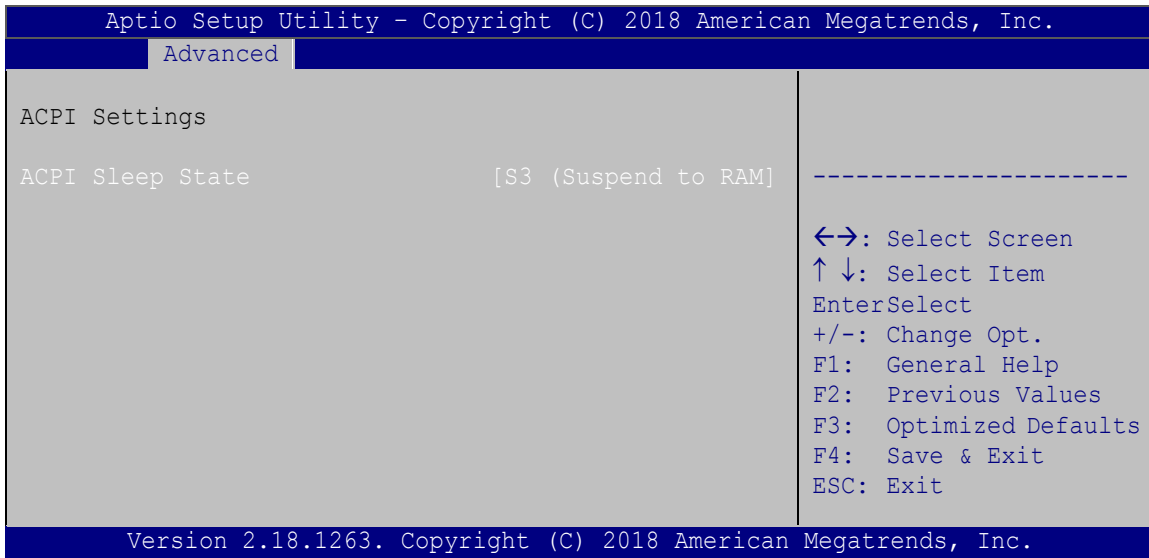

BIOS Menu 3: ACPI Configuration

- ➔ ACPI Sleep State [S3 only (Suspend to RAM)]

The fields in **ACPI Sleep State** option cannot be changed.

- ➔ **S3 (Suspend to DEFAULT RAM)** The caches are flushed and the CPU is powered off. Power to the RAM is maintained. The computer returns slower to a working state, but more power is saved.

WAFER-BT

5.3.2 Super IO Configuration

Use the **Super IO Configuration** menu (**BIOS Menu 4**) to set or change the configurations for the serial ports.

```

Aptio Setup Utility - Copyright (C) 2018 American Megatrends, Inc.
  Advanced
Super IO Configuration
Super IO Chip                F81866
> Serial Port 1 Configuration
> Serial Port 2 Configuration
> Serial Port 3 Configuration
> Serial Port 4 Configuration

Set Parameters of Serial
Port 1 (COMA)
-----
<-->: Select Screen
↑ ↓: Select Item
EnterSelect
F1   General Help
F2   Previous Values
F3   Optimized
Defaults
F4   Save
ESC  Exit

Version 2.18.1263. Copyright (C) 2018 American Megatrends, Inc.
  
```

BIOS Menu 4: Super IO Configuration

5.3.2.1 Serial Port n Configuration

Use the **Serial Port n Configuration** menu (**BIOS Menu 5**) to configure the serial port n.

```

Aptio Setup Utility - Copyright (C) 2018 American Megatrends, Inc.
  Advanced
F81216 Serial Port 1 Configuration
Serial Port                [Enabled]
Device Settings            IO=3F8h; IRQ=4
Change Settings            [Auto]

Enable or Disable Serial
Port (COM)
-----
<-->: Select Screen
↑ ↓: Select Item
EnterSelect
F1   General Help
F2   Previous Values
F3   Optimized
Defaults
F4   Save
ESC  Exit

Version 2.18.1263. Copyright (C) 2018 American Megatrends, Inc.
  
```

BIOS Menu 5: Serial Port n Configuration Menu

5.3.2.1.1 Serial Port 1 Configuration

➔ Serial Port [Enabled]

Use the **Serial Port** option to enable or disable the serial port.

- ➔ **Disabled** Disable the serial port
- ➔ **Enabled** **DEFAULT** Enable the serial port

➔ Change Settings [Auto]

Use the **Change Settings** option to change the serial port IO port address and interrupt address.

- ➔ **Auto** **DEFAULT** The serial port IO port address and interrupt address are automatically detected.
- ➔ **IO=3F8h; IRQ=4** Serial Port I/O port address is 3F8h and the interrupt address is IRQ4
- ➔ **IO=3F8h; IRQ=3, 4,5,6,7,9,10,11,12** Serial Port I/O port address is 3F8h and the interrupt address is IRQ3,4,5,6,7,9,10,11,12
- ➔ **IO=2F8h; IRQ=3, 4,5,6,7,9,10,11,12** Serial Port I/O port address is 2F8h and the interrupt address is IRQ3,4,5,6,7,9,10,11,12
- ➔ **IO=3E8h; IRQ=3, 4,5,6,7,9,10,11,12** Serial Port I/O port address is 3E8h and the interrupt address is IRQ3,4,5,6,7,9,10,11,12
- ➔ **IO=2E8h; IRQ=3, 4,5,6,7,9,10,11,12** Serial Port I/O port address is 2E8h and the interrupt address is IRQ3,4,5,6,7,9,10,11,12

5.3.2.1.2 Serial Port 2 Configuration

➔ Serial Port [Enabled]

Use the **Serial Port** option to enable or disable the serial port.

- ➔ **Disabled** Disable the serial port

WAFER-BT

→ **Enabled** **DEFAULT** Enable the serial port

→ Change Settings [Auto]

Use the **Change Settings** option to change the serial port IO port address and interrupt address.

→ **Auto** **DEFAULT** The serial port IO port address and interrupt address are automatically detected.

→ **IO=2F8h; IRQ=3** Serial Port I/O port address is 2F8h and the interrupt address is IRQ3

→ **IO=3F8h; IRQ=3, 4,5,6,7,9,10,11,12** Serial Port I/O port address is 3F8h and the interrupt address is IRQ3,4,5,6,7,9,10,11,12

→ **IO=2F8h; IRQ=3, 4,5,6,7,9,10,11,12** Serial Port I/O port address is 2F8h and the interrupt address is IRQ3,4,5,6,7,9,10,11,12

→ **IO=3E8h; IRQ=3, 4,5,6,7,9,10,11,12** Serial Port I/O port address is 3E8h and the interrupt address is IRQ3,4,5,6,7,9,10,11,12

→ **IO=2E8h; IRQ=3, 4,5,6,7,9,10,11,12** Serial Port I/O port address is 2E8h and the interrupt address is IRQ3,4,5,6,7,9,10,11,12

5.3.2.1.3 Serial Port 3 Configuration

→ Serial Port [Enabled]

Use the **Serial Port** option to enable or disable the serial port.

→ **Disabled** Disable the serial port

→ **Enabled** **DEFAULT** Enable the serial port

→ Change Settings [Auto]

Use the **Change Settings** option to change the serial port IO port address and interrupt address.

- ➔ **Auto** **DEFAULT** The serial port IO port address and interrupt address are automatically detected.
- ➔ **IO=3E8h; IRQ=7** Serial Port I/O port address is 3E8h and the interrupt address is IRQ7
- ➔ **IO=3E8h; IRQ=3, 4,5,6,7,9,10,11,12** Serial Port I/O port address is 3E8h and the interrupt address is IRQ3,4,5,6,7,9,10,11,12
- ➔ **IO=2E8h; IRQ=3, 4,5,6,7,9,10,11,12** Serial Port I/O port address is 2E8h and the interrupt address is IRQ3,4,5,6,7,9,10,11,12
- ➔ **IO=2F0h; IRQ=3, 4,5,6,7,9,10,11,12** Serial Port I/O port address is 2F0h and the interrupt address is IRQ3,4,5,6,7,9,10,11,12
- ➔ **IO=2E0h; IRQ=3, 4,5,6,7,9,10,11,12** Serial Port I/O port address is 2E0h and the interrupt address is IRQ3,4,5,6,7,9,10,11,12

5.3.2.1.4 Serial Port 4 Configuration

➔ Serial Port [Enabled]

Use the **Serial Port** option to enable or disable the serial port.

- ➔ **Disabled** Disable the serial port
- ➔ **Enabled** **DEFAULT** Enable the serial port

➔ Change Settings [Auto]

Use the **Change Settings** option to change the serial port IO port address and interrupt address.

- ➔ **Auto** **DEFAULT** The serial port IO port address and interrupt address are automatically detected.
- ➔ **IO=2E8h; IRQ=7** Serial Port I/O port address is 2E8h and the interrupt address is IRQ7
- ➔ **IO=3E8h; IRQ=3, 4,5,6,7,9,10,11,12** Serial Port I/O port address is 3E8h and the interrupt address is IRQ3,4,5,6,7,9,10,11,12

WAFER-BT

- ➔ IO=2E8h; IRQ=3, 4,5,6,7,9,10,11,12
Serial Port I/O port address is 2E8h and the interrupt address is IRQ3,4,5,6,7,9,10,11,12
- ➔ IO=2F0h; IRQ=3, 4,5,6,7,9,10,11,12
Serial Port I/O port address is 2F0h and the interrupt address is IRQ3,4,5,6,7,9,10,11,12
- ➔ IO=2E0h; IRQ=3, 4,5,6,7,9,10,11,12
Serial Port I/O port address is 2E0h and the interrupt address is IRQ3,4,5,6,7,9,10,11,12

5.3.3 Hardware Monitor

The Hardware Monitor menu (**BIOS Menu 7**) displays operating temperature.

```

Aptio Setup Utility - Copyright (C) 2018 American Megatrends, Inc.
  Advanced
PC Health Status
System temperature2          :+38 C
Tcc Activation Offset        0
Offset from factory set
Tcc activation
temperature at which the
Thermal Control Circuit
must be activated. Tcc
will be activated at: Tcc
Activation Temp - Tcc
Activation Offset. Tcc
Activation Offset range
is 0 to 63.

-----
<->: Select Screen
↑ ↓: Select Item
EnterSelect
+ - Change Opt.
F1  General Help
F2  Previous Values
F3  Optimized Defaults
F4  Save & Exit
ESC Exit

Version 2.18.1263. Copyright (C) 2018 American Megatrends, Inc.
  
```

BIOS Menu 6: Hardware Monitor

- ➔ PC Health Status

The following system parameters and values are shown. The system parameters that are monitored are:

- System Temperatures:
 - System Temperature2

➔ Tcc Activation Offset

Use the **Tcc Activation Offset** option to change the **Tcc Activation Offset** value. If CPU Temperature reaches Tcc Activation Offset then reduces CPU Frequency.

- Minimum Value: 0°C
- Maximum Value: 63°C

5.3.4 iWDD H/W Monitor

The iWDD H/W Monitor menu (**BIOS Menu 7**) contains the fan configuration submenus and displays operating temperature and fan speeds.

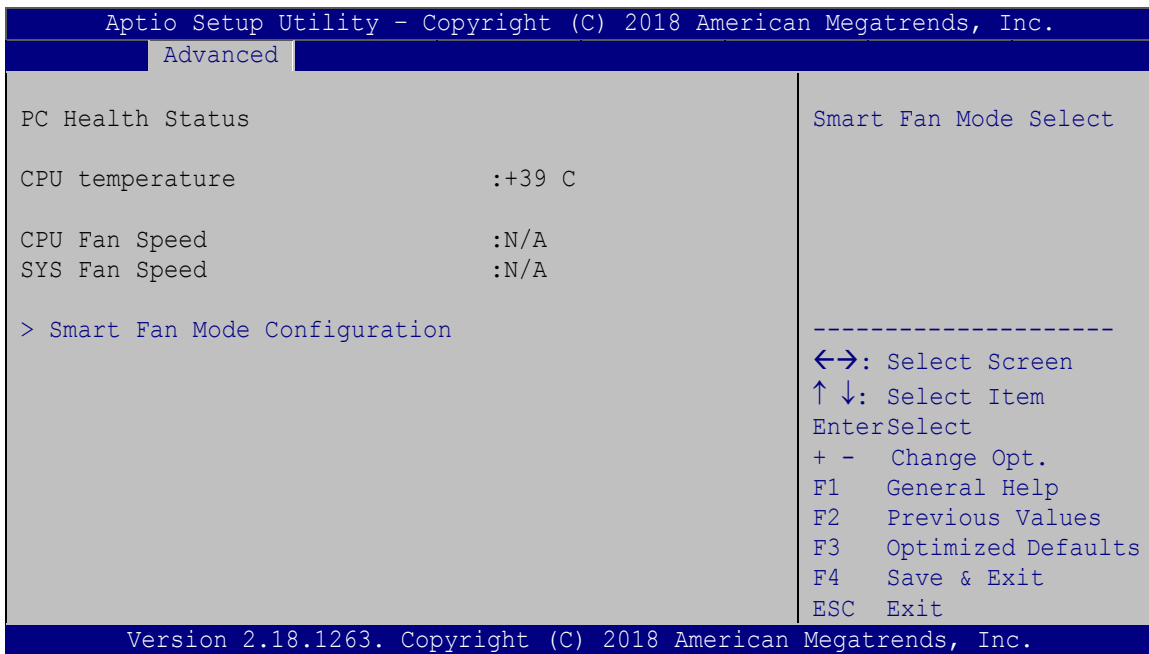

BIOS Menu 7: Hardware Monitor

➔ PC Health Status

The following system parameters and values are shown. The system parameters that are monitored are:

- System Temperatures:

WAFER-BT

- CPU Temperature
- Fan Speed:
 - CPU Fan Speed
 - SYS Fan Speed

5.3.4.1 Smart Fan Mode Configuration

Use the **Smart Fan Mode Configuration submenu (BIOS Menu 8)** to configure fan temperature and speed settings.

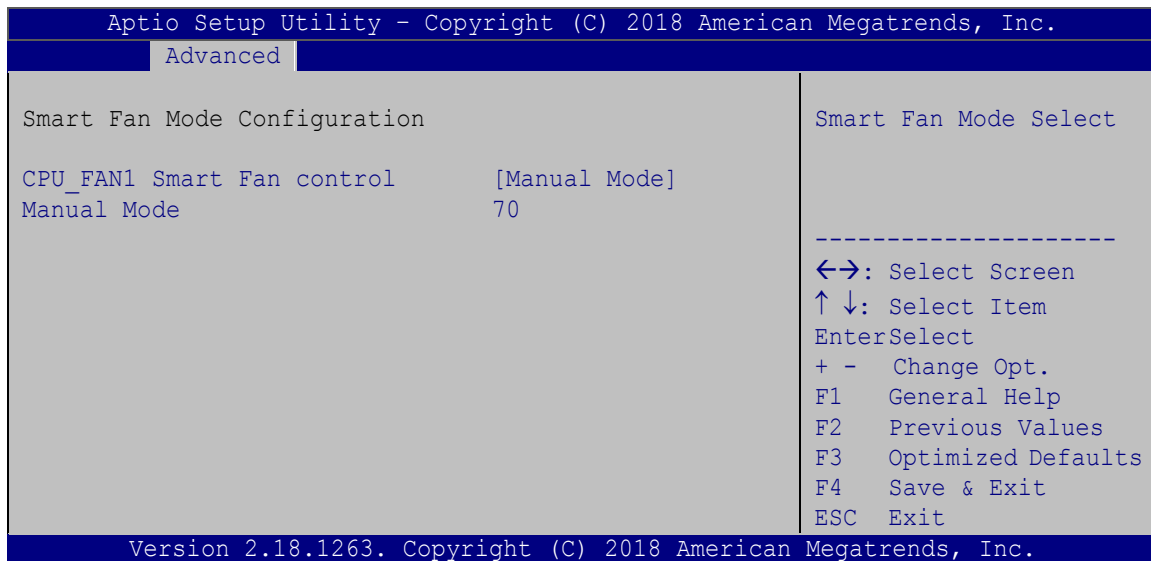

BIOS Menu 8: Smart Fan Mode Configuration

- ➔ CPU_FAN1 Smart Fan control [Manual Mode]

Use the **CPU_FAN1 Smart Fan control** BIOS option to configure the CPU Smart Fan.

- ➔ **Manual Mode** **DEFAULT** The fan spins at the speed set in the manual PWM setting

- ➔ Manual Mode

Use the + or – key to change the fan **Manual Mode** value. Enter a decimal number between 1 and 100.

5.3.5 RTC Wake Settings

The **RTC Wake Settings** menu (**BIOS Menu 9**) configures RTC wake event.

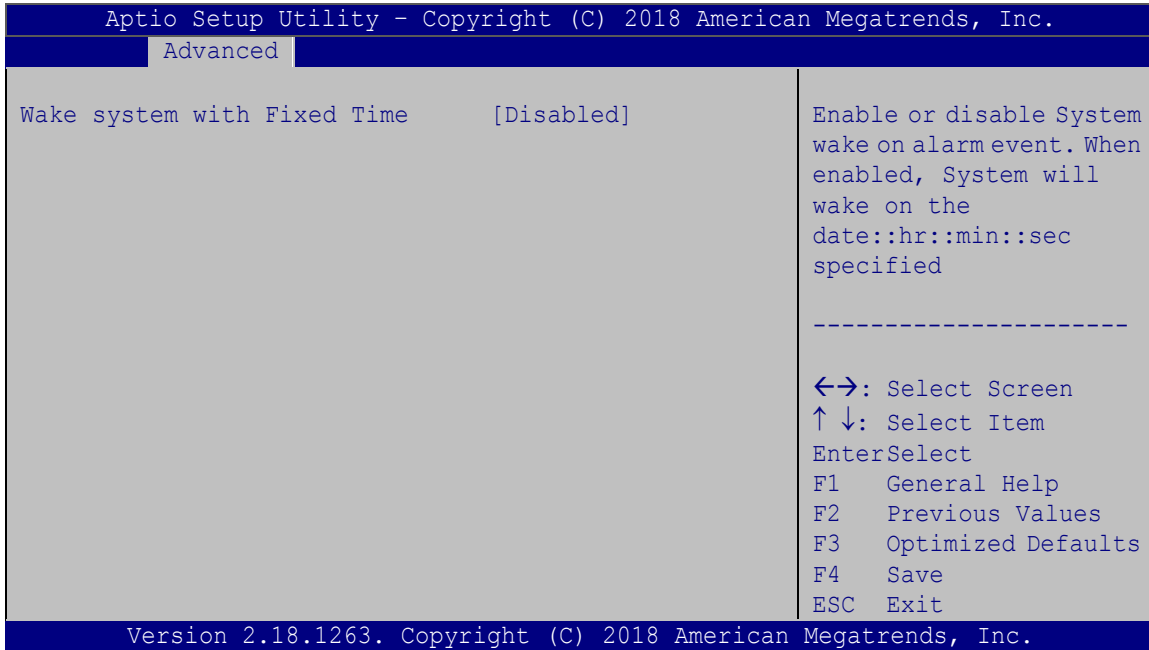

BIOS Menu 9: RTC Wake Settings

→ Wake system with Fixed Time [Disabled]

Use the **Wake system with Fixed Time** option to enable or disable the system wake on alarm event.

→ **Disabled** **DEFAULT** The real time clock (RTC) cannot generate a wake event

→ **Enabled** If selected, the **Wake up every day** option appears allowing you to enable to disable the system to wake every day at the specified time. Besides, the following options appear with values that can be selected:

Wake up date

Wake up hour

Wake up minute

WAFER-BT

Wake up second

After setting the alarm, the computer turns itself on from a suspend state when the alarm goes off.

5.3.6 Serial Port Console Redirection

The **Serial Port Console Redirection** menu (**BIOS Menu 10**) allows the console redirection options to be configured. Console redirection allows users to maintain a system remotely by re-directing keyboard input and text output through the serial port.

```

Aptio Setup Utility - Copyright (C) 2018 American Megatrends, Inc.
  Advanced
COM1
  Console Redirection [Disabled]
> Console Redirection Settings
COM2
  Console Redirection [Disabled]
> Console Redirection Settings
COM3
  Console Redirection [Disabled]
> Console Redirection Settings
COM4
  Console Redirection [Disabled]
> Console Redirection Settings
COM5(SOL) (Disabled)
  Console Redirection Port Is Disabled
-----
<->: Select Screen
↑ ↓: Select Item
Enter>Select
F1  General Help
F2  Previous Values
F3  Optimized
Defaults
F4  Save
ESC Exit
Version 2.18.1263. Copyright (C) 2018 American Megatrends, Inc.
  
```

BIOS Menu 10: Serial Port Console Redirection

➔ Console Redirection [Disabled]

Use **Console Redirection** option to enable or disable the console redirection function.

- ➔ **Disabled** **DEFAULT** Disabled the console redirection function
- ➔ **Enabled** Enabled the console redirection function

5.3.6.1 Console Redirection Settings

The **Console Redirection Settings** menu (**BIOS Menu 11**) allows the console redirection options to be configured. The option is active when Console Redirection option is enabled.

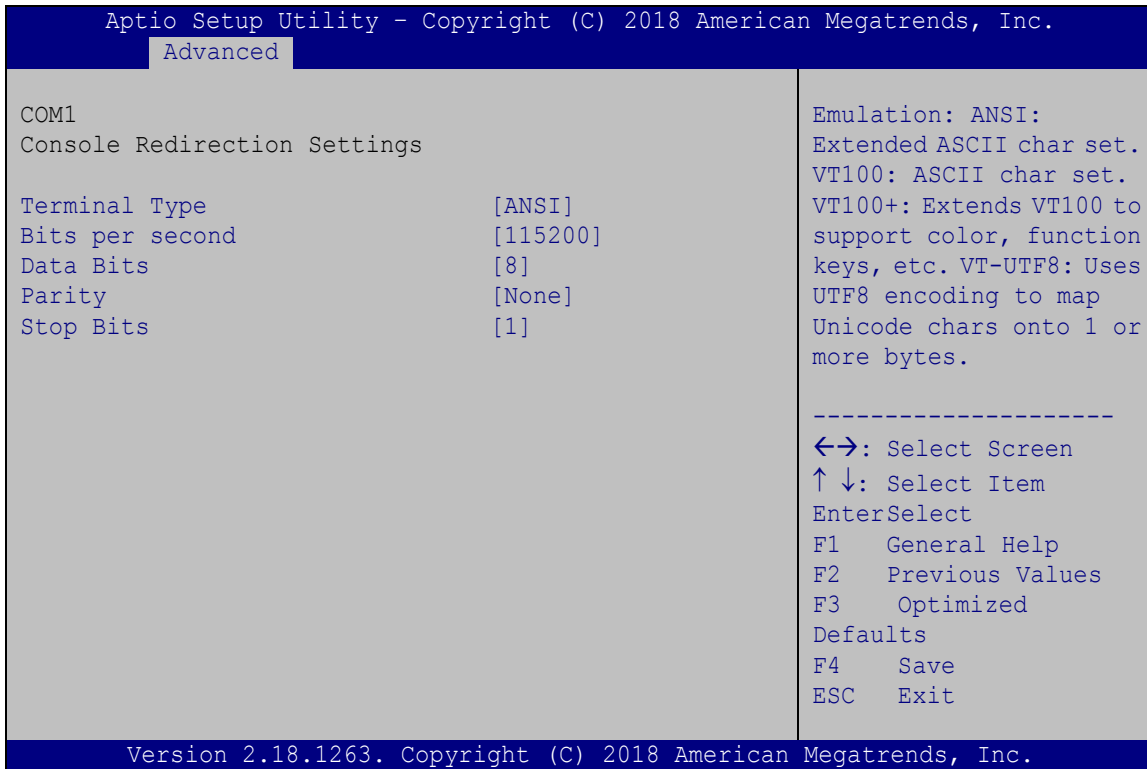

BIOS Menu 11: Console Redirection Settings

➔ Terminal Type [ANSI]

Use the **Terminal Type** option to specify the remote terminal type.

- ➔ **VT100** The target terminal type is VT100
- ➔ **VT100+** The target terminal type is VT100+
- ➔ **VT-UTF8** The target terminal type is VT-UTF8
- ➔ **ANSI** **DEFAULT** The target terminal type is ANSI

WAFER-BT

→ Bits per second [115200]

Use the **Bits per second** option to specify the serial port transmission speed. The speed must match the other side. Long or noisy lines may require lower speeds.

- | | | | |
|---|---------------|----------------|--|
| → | 9600 | | Sets the serial port transmission speed at 9600. |
| → | 19200 | | Sets the serial port transmission speed at 19200. |
| → | 38400 | | Sets the serial port transmission speed at 38400. |
| → | 57600 | | Sets the serial port transmission speed at 57600. |
| → | 115200 | DEFAULT | Sets the serial port transmission speed at 115200. |

→ Data Bits [8]

Use the **Data Bits** option to specify the number of data bits.

- | | | | |
|---|----------|----------------|--------------------------|
| → | 7 | | Sets the data bits at 7. |
| → | 8 | DEFAULT | Sets the data bits at 8. |

→ Parity [None]

Use the **Parity** option to specify the parity bit that can be sent with the data bits for detecting the transmission errors.

- | | | | |
|---|--------------|----------------|---|
| → | None | DEFAULT | No parity bit is sent with the data bits. |
| → | Even | | The parity bit is 0 if the number of ones in the data bits is even. |
| → | Odd | | The parity bit is 0 if the number of ones in the data bits is odd. |
| → | Mark | | The parity bit is always 1. This option does not provide error detection. |
| → | Space | | The parity bit is always 0. This option does not provide error detection. |

➔ Stop Bits [1]

Use the **Stop Bits** option to specify the number of stop bits used to indicate the end of a serial data packet. Communication with slow devices may require more than 1 stop bit.

- ➔ **1** **DEFAULT** Sets the number of stop bits at 1.
- ➔ **2** Sets the number of stop bits at 2.

5.3.7 IEI Feature

Use the **IEI Feature** menu (**BIOS Menu 12**) to configure One Key Recovery function.

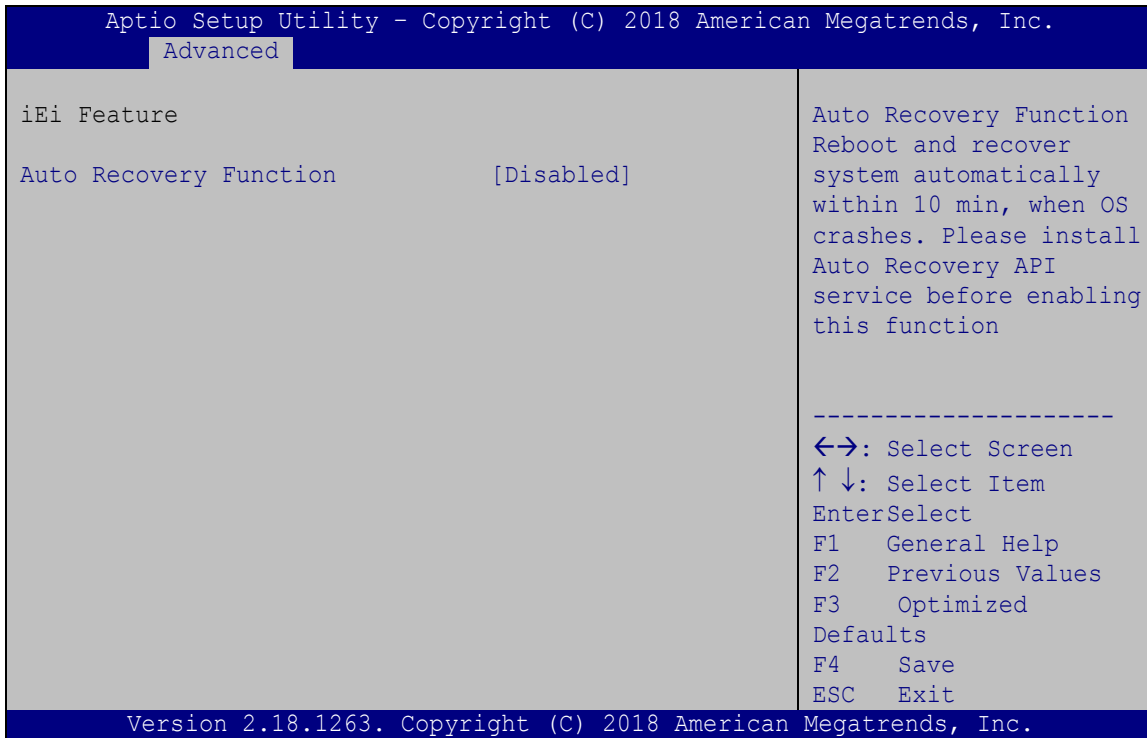

BIOS Menu 12: IEI Feature

➔ Auto Recovery Function [Disabled]

Use the **Auto Recovery Function** BIOS option to enable or disable the auto recovery function of the IEI One Key Recovery.

- ➔ **Disabled** **DEFAULT** Auto recovery function disabled
- ➔ **Enabled** Auto recovery function enabled

WAFER-BT

5.3.8 CPU Configuration

Use the **CPU Configuration** menu (**BIOS Menu 5**) to view detailed CPU specifications and configure the CPU.

```

Aptio Setup Utility - Copyright (C) 2018 American Megatrends, Inc.
  Advanced
CPU Configuration
> Socket 0 CPU Information
64-bit                Supported
Intel Virtualization Technology [Enabled]
EIST                   [Enabled]
CPU C state Report    [Disabled]
Socket specific CPU Information
-----
<->: Select Screen
↑ ↓: Select Item
Enter>Select
F1   General Help
F2   Previous Values
F3   Optimized
Defaults
F4   Save
ESC  Exit
Version 2.18.1263. Copyright (C) 2018 American Megatrends, Inc.
  
```

BIOS Menu 13: CPU Configuration

→ Intel® Virtualization Technology [Disabled]

Use the **Intel® Virtualization Technology** option to enable or disable virtualization on the system. When combined with third party software, Intel Virtualization technology allows several OSs to run on the same system at the same time.

→ **Disabled** **DEFAULT** Disables Intel Virtualization Technology.

→ **Enabled** Enables Intel Virtualization Technology.

→ EIST [Enabled]

Use the **EIST** option to enable or disable the Intel Speed Step Technology.

→ **Disabled** Disables the Intel Speed Step Technology.

→ **Enabled** **DEFAULT** Enables the Intel Speed Step Technology.

5.3.8.1 Socket 0 CPU Information

Use the **Socket 0 CPU Information** submenu (**BIOS Menu 14**) to view detailed CPU specifications and configure the CPU.

```

Aptio Setup Utility - Copyright (C) 2018 American Megatrends, Inc.
  Advanced
Socket 0 CPU Information

Intel(R) Celeron(R) CPU N2807 @ 1.58GHz
CPU Signature                30679
Microcode Patch              90a
Max CPU Speed                1580 MHz
Min CPU Speed                500 MHz
Processor Cores              2
Intel HT Technology          Not Supported
Intel VT-x Technology        Supported

L1 Data Cache                24 kB x 2
L1 Code Cache                32 kB x 2
L2 Cache                     1024 kB x 1
L3 Cache                     Not Present

-----
<->: Select Screen
↑ ↓: Select Item
Enter>Select
+/-: Change Opt.
F1: General Help
F2: Previous Values
F3: Optimized Defaults
F4: Save & Exit
ESC: Exit

Version 2.18.1263. Copyright (C) 2018 American Megatrends, Inc.

```

BIOS Menu 14: CPU Configuration

The CPU Configuration menu (**BIOS Menu 14**) lists the following CPU details:

- Processor Type: Lists the brand name of the CPU being used
- CPU Signature: Lists the CPU signature value.
- Microcode Patch: Lists the microcode patch being used.
- Max CPU Speed: Lists the maximum CPU processing speed.
- Min CPU Speed: Lists the minimum CPU processing speed.
- Processor Cores: Lists the number of the processor core
- Intel HT Technology: Indicates if Intel HT Technology is supported by the CPU.
- Intel VT-x Technology: Indicates if Intel VT-x Technology is supported by the CPU.
- L1 Data Cache: Lists the amount of data storage space on the L1 cache.
- L1 Code Cache: Lists the amount of code storage space on the L1 cache.
- L2 Cache: Lists the amount of storage space on the L2 cache.
- L3 Cache: Lists the amount of storage space on the L3 cache.

WAFER-BT

5.3.9 IDE Configuration

Use the **IDE Configuration** menu (**BIOS Menu 15**) to change and/or set the configuration of the SATA devices installed in the system.

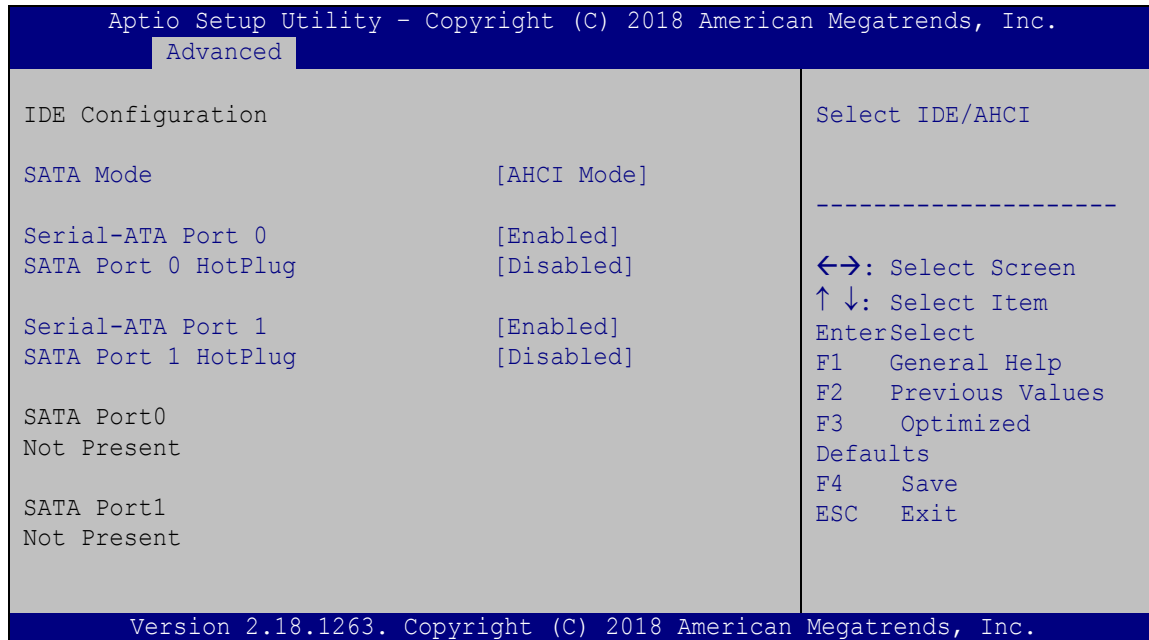

BIOS Menu 15: IDE Configuration

➔ Serial-ATA (SATA) [Enabled]

Use the **Serial-ATA (SATA)** option to enable or disable the serial ATA controller.

- ➔ **Enabled** **DEFAULT** Enables the on-board SATA controller.
- ➔ **Disabled** Disables the on-board SATA controller.

➔ SATA Mode [ACHI Mode]

Use the **SATA Mode** option to configure SATA devices as normal IDE devices.

- ➔ **IDE Mode** Configures SATA devices as normal IDE device.
- ➔ **ACHI Mode** **DEFAULT** Configures SATA devices as AHCI device.

➔ Serial-ATA Port 0/1 [Enabled]

Use the **Serial-ATA Port 0/1** option to enable or disable the SATA device.

- ➔ **Disabled** Disables the SATA device.
- ➔ **Enabled** **DEFAULT** Enables the SATA device.

➔ SATA Port 0/1 HotPlug [Disabled]

Use the **Serial-ATA Port 0/1 HotPlug** option to enable or disable the SATA device hot plug.

- ➔ **Disabled** Disables the SATA device hot plug.
- ➔ **Enabled** **DEFAULT** Enables the SATA device hot plug

5.3.10 USB Configuration

Use the **USB Configuration** menu (**BIOS Menu 16**) to read USB configuration information and configure the USB settings.

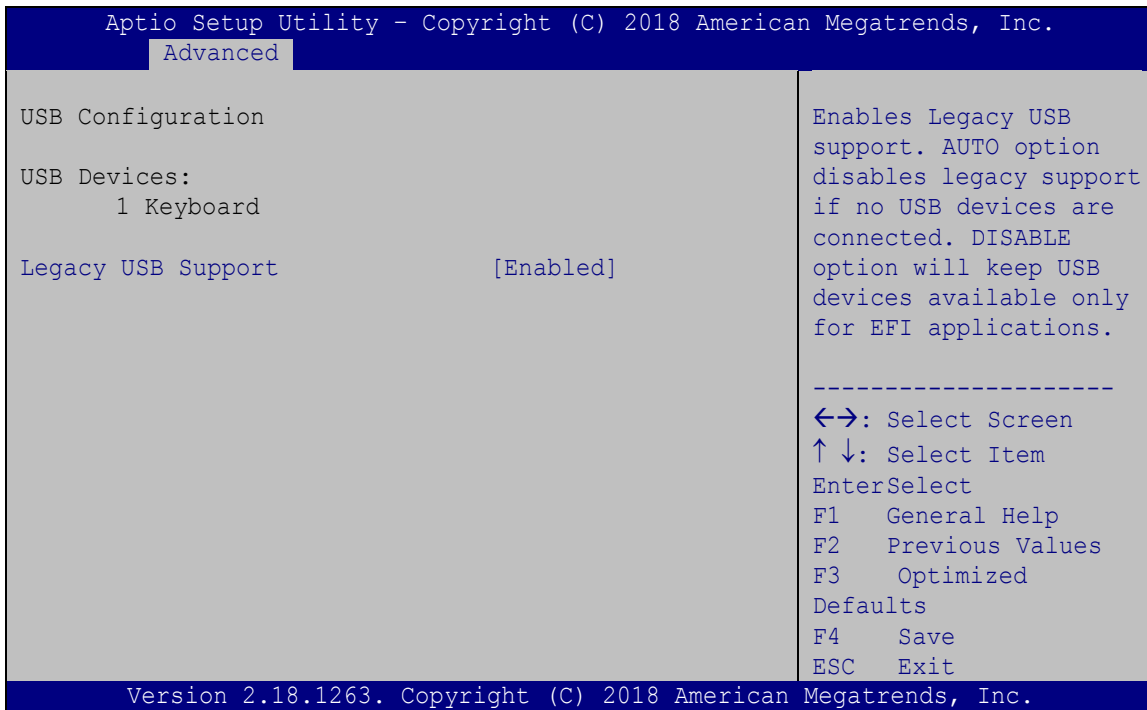

BIOS Menu 16: USB Configuration

WAFER-BT

→ USB Devices

The **USB Devices Enabled** field lists the USB devices that are enabled on the system

→ Legacy USB Support [Enabled]

Use the **Legacy USB Support** BIOS option to enable USB mouse and USB keyboard support. Normally if this option is not enabled, any attached USB mouse or USB keyboard does not become available until a USB compatible operating system is fully booted with all USB drivers loaded. When this option is enabled, any attached USB mouse or USB keyboard can control the system even when there is no USB driver loaded onto the system.

→	Enabled	DEFAULT	Legacy USB support enabled
→	Disabled		Legacy USB support disabled
→	Auto		Legacy USB support disabled if no USB devices are connected

5.4 Chipset

Use the **Chipset** menu (**BIOS Menu 17**) to access the Northbridge and Southbridge configuration menus



WARNING!

Setting the wrong values for the Chipset BIOS selections in the Chipset BIOS menu may cause the system to malfunction.

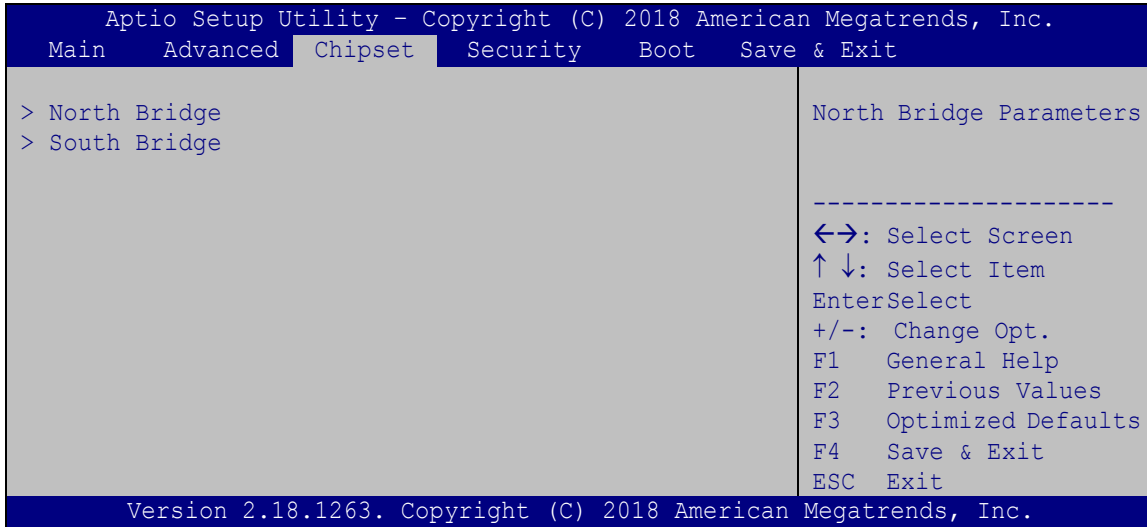

BIOS Menu 17: Chipset

5.4.1 North Bridge Configuration

Use the **North Bridge Configuration** menu (**BIOS Menu 18**) to configure the Intel IGD settings.

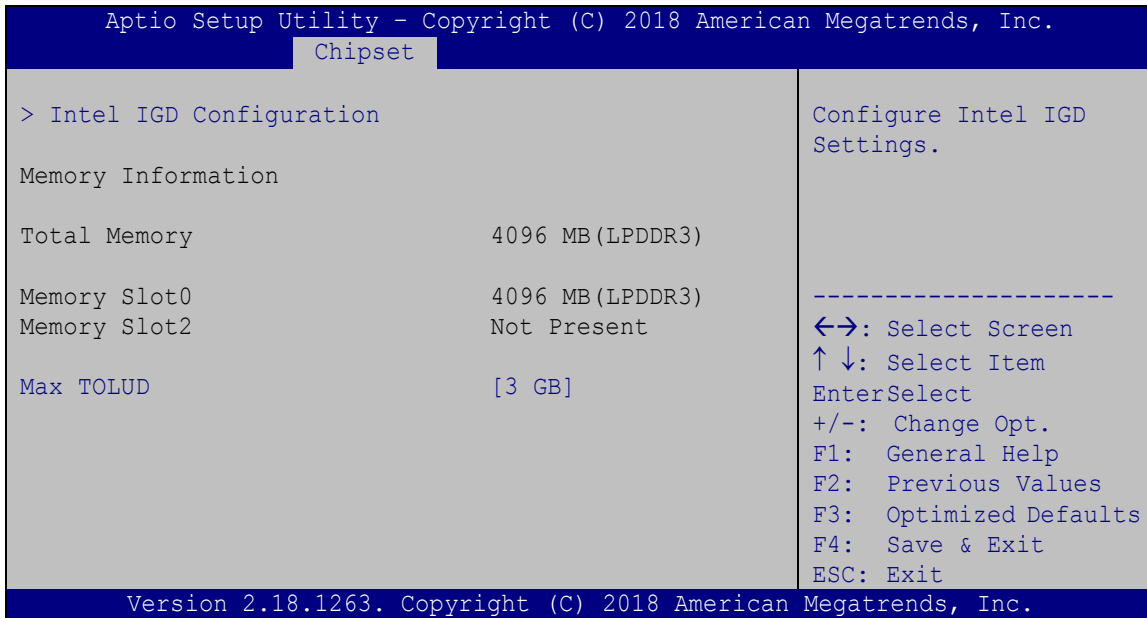

BIOS Menu 18: Northbridge Chipset Configuration

WAFER-BT

→ Memory Information

The **Memory Information** lists a brief summary of the on-board memory. The fields in **Memory Information** cannot be changed.

→ Max TOLUD [2.75 GB]

Use the **Max TOLUD** option to select the maximum value of TOLUD.. The following options are available:

- 2 GB
- 2.25 GB
- 2.5 GB
- 2.75 GB
- 3 GB **Default**

5.4.1.1 Intel IGD Configuration

Use the **Intel IGD Configuration** menu (**BIOS Menu 19**) to configure the video device connected to the system.

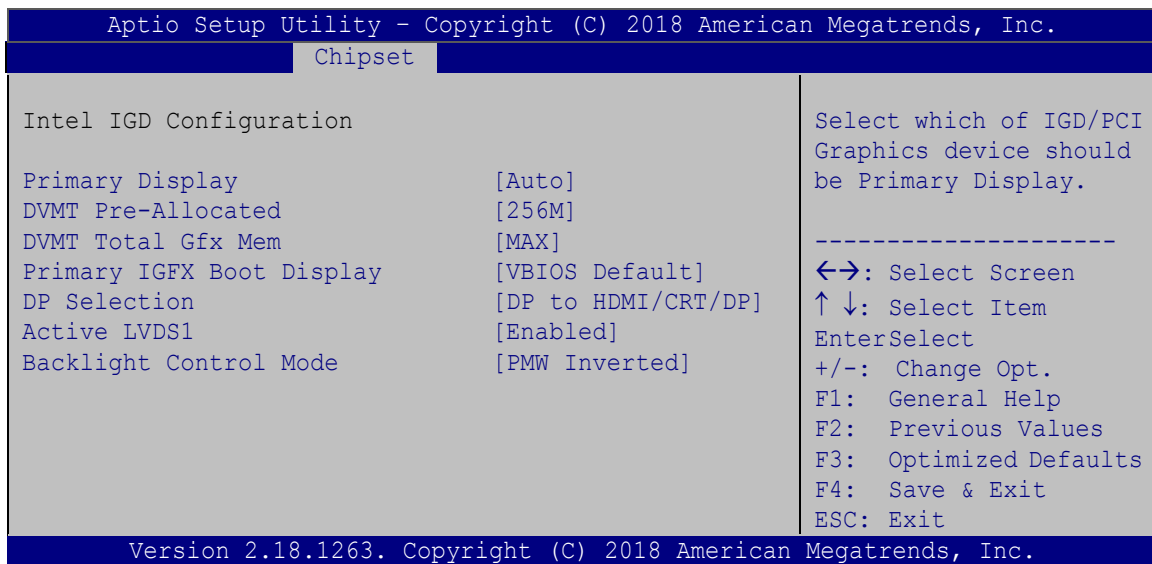

BIOS Menu 19: Integrated Graphics

→ Primary Display [Auto]

Use the **Primary Display** option to select the primary graphics controller the system uses.

The following options are available:

- Auto **Default**
- IGD
- PCIe
- SG

→ DVMT Pre-Allocated [256M]

Use the **DVMT Pre-Allocated** option to set the amount of system memory allocated to the integrated graphics processor when the system boots. The system memory allocated can then only be used as graphics memory, and is no longer available to applications or the operating system. Configuration options are listed below:

- 64M
- 128M
- 256M **Default**
- 512M

→ DVMT Total Gfx Mem [MAX]

Use the **DVMT Total Gfx Mem** option to select DVMT5.0 total graphic memory size used by the internal graphic device. The following options are available:

- 128M
- 256M
- MAX **Default**

→ Primary IGFX Boot Display [VBIOS Default]

Use the **Primary IGFX Boot Display** option to select the display device used by the system when it boots. Configuration options are listed below.

- VBIOS Default **DEFAULT**
- CRT
- LVDS
- DP Port

WAFER-BT

→ DP Selection [DP to HDMI/CRT/DP]

Use the **DP Selection** option to select the display device connected to the internal display port (DP1). Configuration options are listed below.

- DP to LVDS
- DP to HDMI/CRT/DP **DEFAULT**

→ Active LVDS1 [Enabled]

Use the **Active LVDS1** BIOS option to enable or disable LVDS.

- **Enabled** **DEFAULT** LVDS is enabled
- **Disabled** LVDS is disabled

→ Backlight Control Mode [PWM Inverted]

Use the **Backlight Control Mode** option to select the backlight control mode.

- **PWM Normal** Brightest at high voltage level
- **PWM Inverted** **DEFAULT** Brightest at low voltage level

5.4.2 Southbridge Configuration

Use the **Southbridge Configuration** menu (**BIOS Menu 20**) to configure the Southbridge chipset.

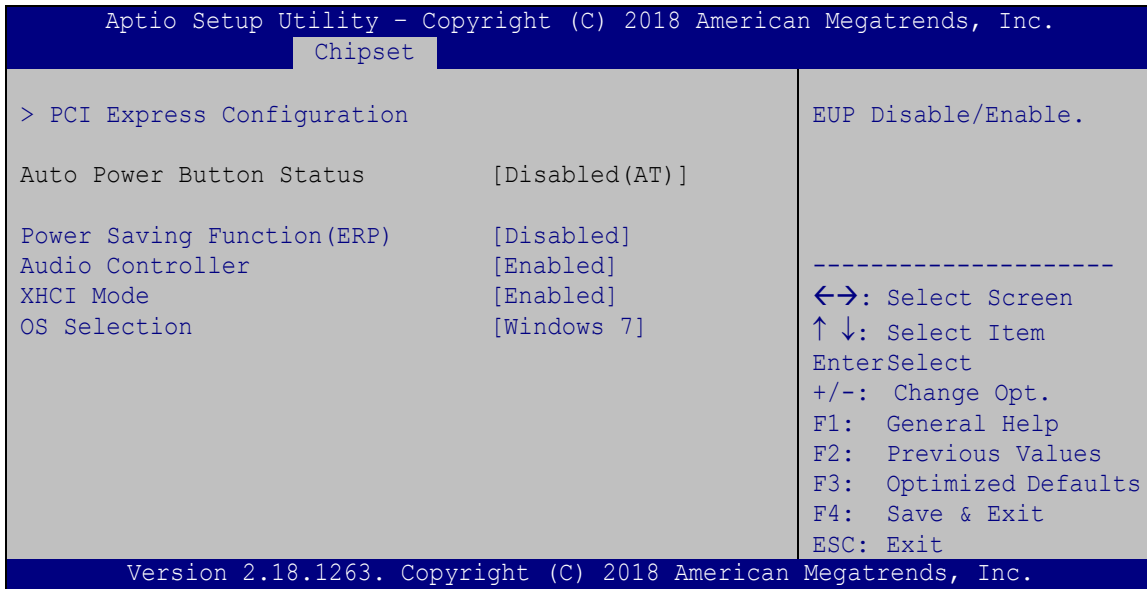

BIOS Menu 20: Southbridge Chipset Configuration

→ Power Saving Function(ERP) [Disabled]

Use the **Power Saving Function(ERP)** BIOS option to enable or reduce power consumption in the S5 state. When enabled, the system can only be powered-up using the power button.

→ **Disabled** **DEFAULT** Power saving function support disabled

→ **Enabled** Power saving function support enabled

→ Audio Controller [Enabled]

Use the **Audio Controller** option to enable or disable the High Definition Audio controller.

→ **Disabled** The onboard High Definition Audio controller is disabled

→ **Enabled** **DEFAULT** The onboard High Definition Audio controller is detected automatically and enabled

WAFER-BT

→ XHCI Mode [Auto]

Use the **XHCI Mode** BIOS option to configure the USB xHCI (USB 3.0) controller. If the system is running Windows 7 operating system, the USB 3.0 driver must be installed to support USB 3.0.

- | | | | |
|---|-------------------|----------------|--|
| → | Enabled | | Enable the XHCI controller. |
| → | Disabled | | Disable the XHCI controller. |
| → | Auto | DEFAULT | Enable the XHCI controller. |
| → | Smart Auto | | Allow the use of USB 3.0 devices prior to OS boot. USB 3.0 ports function as USB 3.0 ports even during a reboot. |

→ OS Selection [Windows 7]

Use the **OS Selection** BIOS option to select the OS. Configuration options are listed below.

- Windows 8.X
- Android
- Windows 7 **DEFAULT**

5.4.2.1 PCI Express Configuration

Use the **PCI Express Configuration** menu (**BIOS Menu 20**) to configure the PCI Express.

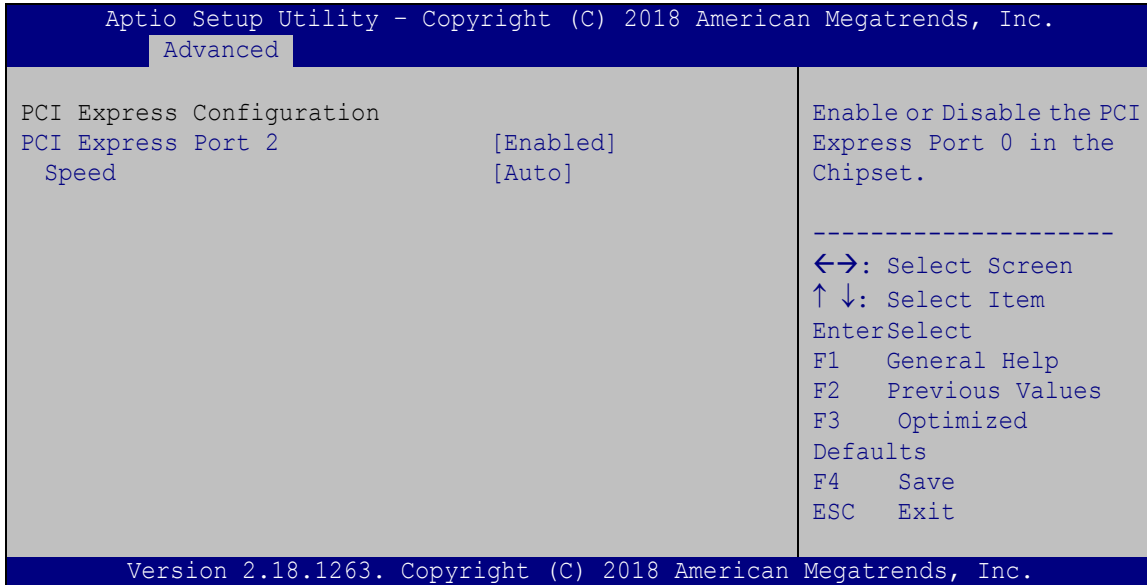

BIOS Menu 21: Console Redirection Settings

→ PCI Express Port [Enabled]

Use the **PCI Express Port** option to enable or disable the PCI Express port.

- **Disabled** Disables the PCI Express port.
- **Enabled** **DEFAULT** Enables the PCI Express port.

→ Speed [Auto]

Use the **Speed** option to configure PCIe port speed.

- **Auto** Configure PCIe port speed to auto
- **Gen 2** Configure PCIe port speed to Gen2
- **Gen 1** Configure PCIe port speed to Gen1

WAFER-BT

5.5 Security

Use the **Security** menu (**BIOS Menu 22**) to set system and user passwords.

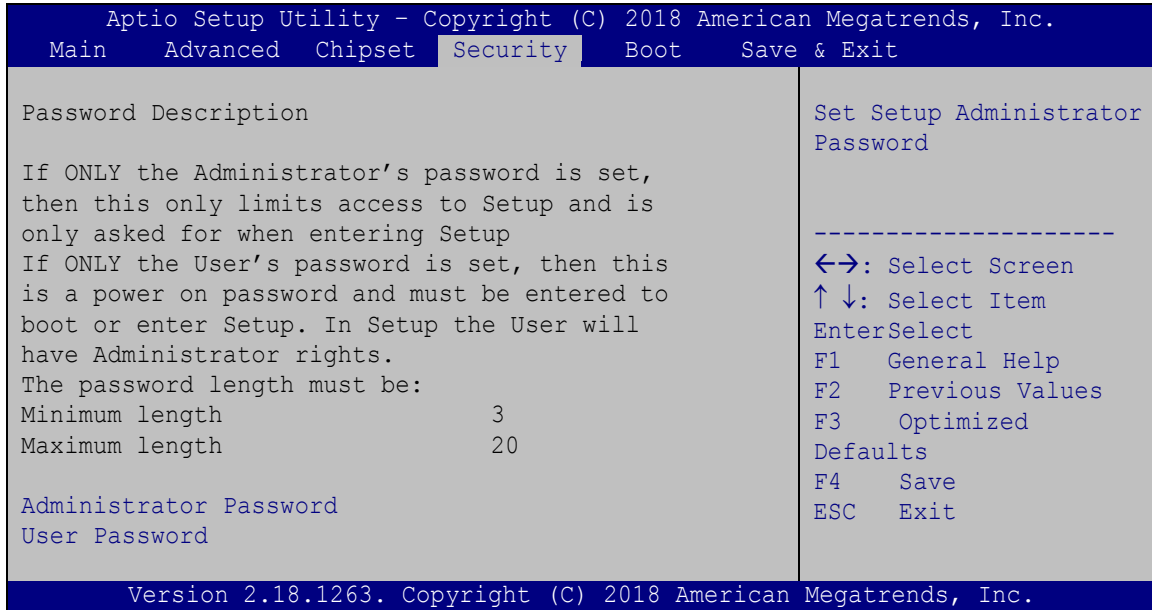

BIOS Menu 22: Security

➔ Administrator Password

Use the **Administrator Password** to set or change a administrator password.

➔ User Password

Use the **User Password** to set or change a user password.

5.6 Boot

Use the **Boot** menu (**BIOS Menu 20**) to configure system boot options.

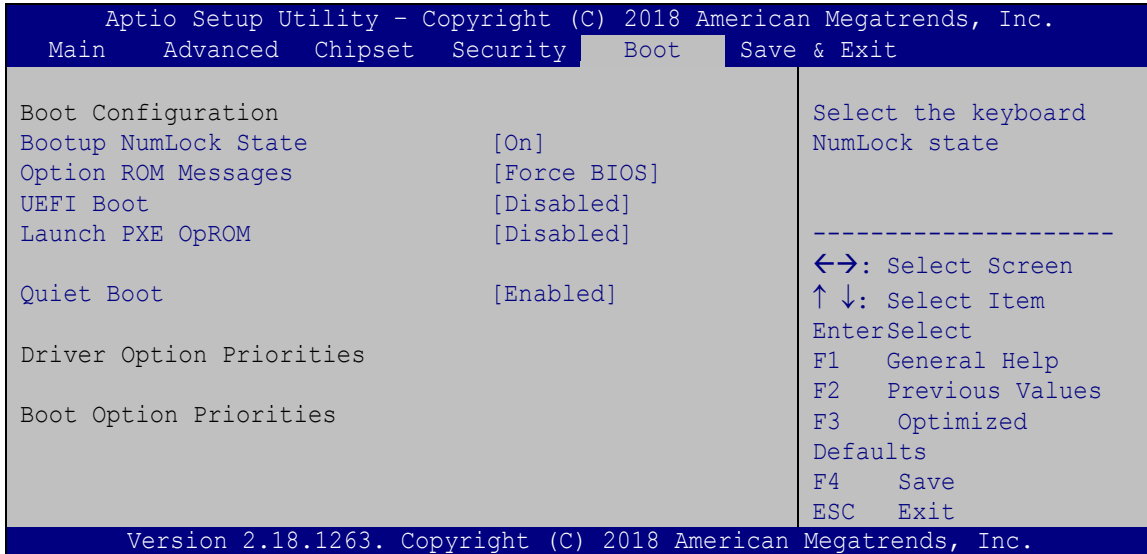

BIOS Menu 23: Boot

→ Bootup NumLock State [On]

Use the **Bootup NumLock State** BIOS option to specify if the number lock setting must be modified during boot up.

→ **On** **DEFAULT** Allows the Number Lock on the keyboard to be enabled automatically when the computer system boots up. This allows the immediate use of the 10-key numeric keypad located on the right side of the keyboard. To confirm this, the Number Lock LED light on the keyboard is lit.

→ **Off** Does not enable the keyboard Number Lock automatically. To use the 10-keys on the keyboard, press the Number Lock key located on the upper left-hand corner of the 10-key pad. The Number Lock LED on the keyboard lights up when the Number Lock is engaged.

WAFER-BT

→ Option ROM Messages [Force BIOS]

Use the **Option ROM Messages** option to set the Option ROM display mode.

- **Force BIOS** **DEFAULT** Sets display mode to force BIOS.
- **Keep Current** Sets display mode to current.

→ UEFI Boot [Disabled]

Use the **UEFI Boot** option to enable or disable to boot from the UEFI devices.

- **Auto** If the first boot HDD is GPT then enable UEFI boot options, otherwise disable,
- **Enabled** Boot from UEFI devices is enabled.
- **Disabled** **DEFAULT** Boot from UEFI devices is disabled.

→ Launch PXE OpROM [Disabled]

Use the **Launch PXE OpROM** option to enable or disable boot option for legacy network devices.

- **Disabled** **DEFAULT** Ignore all PXE Option ROMs
- **Enabled** Load PXE Option ROMs.

→ Quiet Boot [Enabled]

Use the **Quiet Boot** BIOS option to select the screen display when the system boots.

- **Disabled** Normal POST messages displayed
- **Enabled** **DEFAULT** OEM Logo displayed instead of POST messages

→ Boot Option Priority

Use the **Boot Option Priority** function to set the system boot sequence from the available devices. The drive sequence also depends on the boot sequence in the individual device section.

5.7 Exit

Use the **Exit** menu (**BIOS Menu 24**) to load default BIOS values, optimal failsafe values and to save configuration changes.

```
Aptio Setup Utility - Copyright (C) 2018 American Megatrends, Inc.
Main   Advanced  Chipset  Security  Boot   Save & Exit
-----
Save Changes and Reset
Discard Changes and Reset

Restore Defaults
Save as User Defaults
Restore User Defaults

Reset the system after
saving the changes.

-----
<->: Select Screen
↑ ↓: Select Item
Enter>Select
F1   General Help
F2   Previous Values
F3   Optimized
Defaults
F4   Save
ESC  Exit

Version 2.18.1263. Copyright (C) 2018 American Megatrends, Inc.
```

BIOS Menu 24:Exit

→ Save Changes and Reset

Use the **Save Changes and Reset** option to save the changes made to the BIOS options and to exit the BIOS configuration setup program.

→ Discard Changes and Reset

Use the **Discard Changes and Reset** option to exit the system without saving the changes made to the BIOS configuration setup program.

WAFER-BT

→ Restore Defaults

Use the **Restore Defaults** option to load the optimal default values for each of the parameters on the Setup menus. **F3 key can be used for this operation.**

→ Save as User Defaults

Use the **Save as User Defaults** option to save the changes done so far as user defaults.

→ Restore User Defaults

Use the **Restore User Defaults** option to restore the user defaults to all the setup options.

5.8 Server Mgmt

Use the **Server Mgmt** menu (BIOS Menu 25) to access the server management menus.

```

Aptio Setup Utility - Copyright (C) 2018 American Megatrends, Inc.
Server Mgmt
BMC Self Test Status          FAILED
BMC Firmware Revision         Unknown
> System Event Log
> BMC network configuration

-----
←→: Select Screen
↑ ↓: Select Item
EnterSelect
+ - Change Opt.
F1  General Help
F2  Previous Values
F3  Optimized Defaults
F4  Save & Exit
ESC Exit

Version 2.18.1263. Copyright (C) 2018 American Megatrends, Inc.
    
```

BIOS Menu 25: Server Mgmt

5.8.1.1 System Event Log

Use the **System Event Log** menu (BIOS Menu 26) to configure the event log.

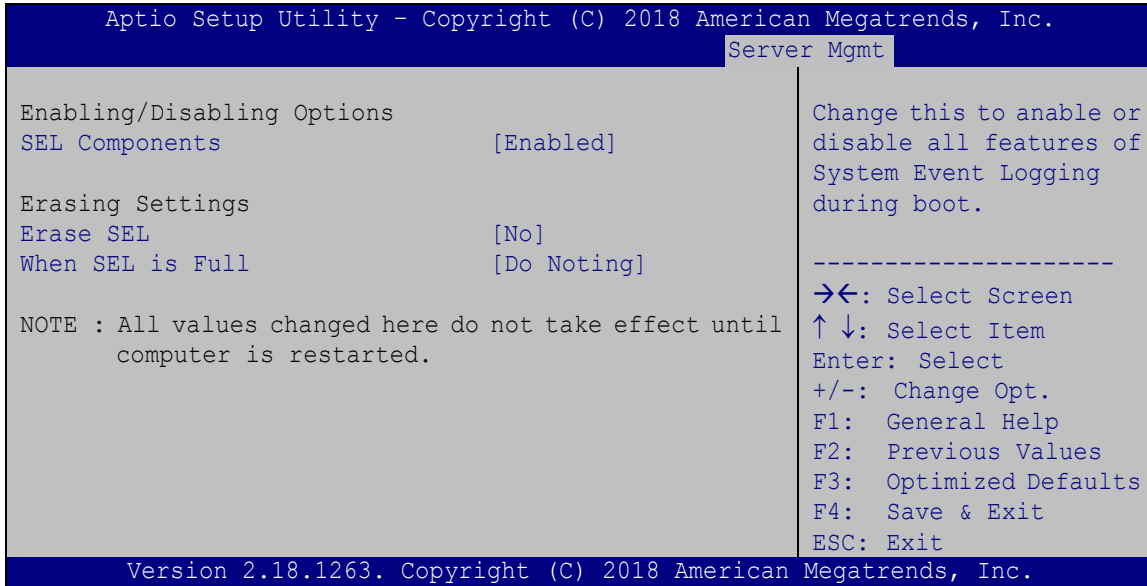

BIOS Menu 26: System Event Log

→ SEL Components [Enabled]

Use the **SEL Components** option to enable or disable all features of system event logging during boot.

→ **Disabled** Disables all features of system event logging during boot.

→ **Enabled** **DEFAULT** Enables all features of system event logging during boot.

→ Erase SEL [No]

Use **Erase SEL** option to select options for erasing SEL. The following options are available:

- No **Default**
- Yes, On next reset
- Yes, On every reset

WAFER-BT

➔ When SEL is Full [Do Nothing]

Use **When SEL is FULL** option to select options for reactions to a full SEL. The following options are available:

- Do Nothing **Default**
- Erase Immediately

5.8.1.2 BMC network configuration

Use the **BMC network configuration** menu (BIOS Menu 27) to configure BMC network parameters.

```

Aptio Setup Utility - Copyright (C) 2018 American Megatrends, Inc.
Server Mgmt
BMC network configuration
Lan channel 1
Configuration Address source [Unspecified]
Current Configuration Address source -
Station IP address -
Subnet mask -
Station MAC address -
Router IP address -
Router MAC address -
Select to configure LAN channel parameters statically or dynamically (by BIOS or BMC). Unspecified option will not modify any BMC network parameters during BIOS phase.
-----
-><: Select Screen
↑↓: Select Item
Enter: Select
+/-: Change Opt.
F1: General Help
F2: Previous Values
F3: Optimized Defaults
F4: Save & Exit
ESC: Exit
Version 2.18.1263. Copyright (C) 2018 American Megatrends, Inc.
    
```

BIOS Menu 27: PCH Azalia Configuration Menu

➔ Configuration Address source [Unspecified]

Use **Configuration Address source** option to configure LAN channel parameters. The following options are available:

- Unspecified **Default**
- Static
- DynamicBmcDhcp
- DynamicBmcNonDhcp

Appendix

A

Regulatory Compliance

WAFER-BT

DECLARATION OF CONFORMITY



This equipment has been tested and found to comply with specifications for CE marking. If the user modifies and/or installs other devices in the equipment, the CE conformity declaration may no longer apply.

FCC WARNING



This equipment complies with Part 15 of the FCC Rules. Operation is subject to the following two conditions:

- This device may not cause harmful interference, and
- This device must accept any interference received, including interference that may cause undesired operation.

This equipment has been tested and found to comply with the limits for a Class A digital device, pursuant to part 15 of the FCC Rules. These limits are designed to provide reasonable protection against harmful interference when the equipment is operated in a commercial environment. This equipment generates, uses, and can radiate radio frequency energy and, if not installed and used in accordance with the instruction manual, may cause harmful interference to radio communications. Operation of this equipment in a residential area is likely to cause harmful interference in which case the user will be required to correct the interference at his own expense.

Appendix

B

Product Disposal

**CAUTION:**

Risk of explosion if battery is replaced by an incorrect type. Only certified engineers should replace the on-board battery.

Dispose of used batteries according to instructions and local regulations.

- Outside the European Union – If you wish to dispose of used electrical and electronic products outside the European Union, please contact your local authority so as to comply with the correct disposal method.
- Within the European Union – The device that produces less waste and is easier to recycle is classified as electronic device in terms of the European Directive 2012/19/EU (WEEE), and must not be disposed of as domestic garbage.

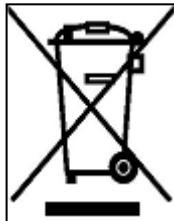

EU-wide legislation, as implemented in each Member State, requires that waste electrical and electronic products carrying the mark (left) must be disposed of separately from normal household waste. This includes monitors and electrical accessories, such as signal cables or power cords. When you need to dispose of your device, please follow the guidance of your local authority, or ask the shop where you purchased the product. The mark on electrical and electronic products only applies to the current European Union Member States.

Please follow the national guidelines for electrical and electronic product disposal.

Appendix

C

BIOS Menu Options

WAFER-BT

➔ System Date [xx/xx/xx]	65
➔ System Time [xx:xx:xx]	65
➔ ACPI Sleep State [S3 only (Suspend to RAM)]	66
➔ Serial Port [Enabled].....	68
➔ Change Settings [Auto]	68
➔ Serial Port [Enabled].....	68
➔ Change Settings [Auto]	69
➔ Serial Port [Enabled].....	69
➔ Change Settings [Auto]	69
➔ Serial Port [Enabled].....	70
➔ Change Settings [Auto]	70
➔ PC Health Status	71
➔ Tcc Activation Offset	72
➔ PC Health Status	72
➔ CPU_FAN1 Smart Fan control [Manual Mode].....	73
➔ Manual Mode	73
➔ Wake system with Fixed Time [Disabled].....	74
➔ Console Redirection [Disabled].....	75
➔ Terminal Type [ANSI].....	76
➔ Bits per second [115200].....	77
➔ Data Bits [8]	77
➔ Parity [None].....	77
➔ Stop Bits [1].....	78
➔ Auto Recovery Function [Disabled].....	78
➔ Intel® Virtualization Technology [Disabled].....	79
➔ EIST [Enabled].....	79
➔ Serial-ATA (SATA) [Enabled]	81
➔ SATA Mode [ACHI Mode]	81
➔ Serial-ATA Port 0/1 [Enabled].....	82
➔ SATA Port 0/1 HotPlug [Disabled].....	82
➔ USB Devices	83
➔ Legacy USB Support [Enabled].....	83
➔ Memory Information	85
➔ Max TOLUD [2.75 GB].....	85

→ Primary Display [Auto]	86
→ DVMT Pre-Allocated [256M]	86
→ DVMT Total Gfx Mem [MAX].....	86
→ Primary IGFX Boot Display [VBIOS Default]	86
→ DP Selection [DP to HDMI/CRT/DP]	87
→ Active LVDS1 [Enabled]	87
→ Backlight Control Mode [PWM Inverted]	87
→ Power Saving Function(ERP) [Disabled]	88
→ Audio Controller [Enabled]	88
→ XHCI Mode [Auto]	89
→ OS Selection [Windows 7].....	89
→ PCI Express Port [Enabled]	90
→ Speed [Auto].....	90
→ Administrator Password	91
→ User Password	91
→ Bootup NumLock State [On].....	92
→ Option ROM Messages [Force BIOS].....	93
→ UEFI Boot [Disabled]	93
→ Launch PXE OpROM [Disabled]	93
→ Quiet Boot [Enabled]	93
→ Boot Option Priority.....	94
→ Save Changes and Reset	94
→ Discard Changes and Reset	94
→ Restore Defaults	95
→ Save as User Defaults	95
→ Restore User Defaults	95
→ SEL Components [Enabled].....	96
→ Erase SEL [No]	96
→ When SEL is Full [Do Nothing].....	97
→ Configuration Address source [Unspecified]	97

Appendix

D

Terminology

AC '97	Audio Codec 97 (AC'97) refers to a codec standard developed by Intel® in 1997.
ACPI	Advanced Configuration and Power Interface (ACPI) is an OS-directed configuration, power management, and thermal management interface.
AHCI	Advanced Host Controller Interface (AHCI) is a SATA Host controller register-level interface.
ATA	The Advanced Technology Attachment (ATA) interface connects storage devices including hard disks and CD-ROM drives to a computer.
APM	The Advanced Power Management (APM) application program interface (API) enables the inclusion of power management in the BIOS.
ARMD	An ATAPI Removable Media Device (ARMD) is any ATAPI device that supports removable media, besides CD and DVD drives.
ASKIR	Amplitude Shift Keyed Infrared (ASKIR) is a form of modulation that represents a digital signal by varying the amplitude (“volume”) of the signal. A low amplitude signal represents a binary 0, while a high amplitude signal represents a binary 1.
BIOS	The Basic Input/Output System (BIOS) is firmware that is first run when the computer is turned on and can be configured by the end user
CODEC	The Compressor-Decompressor (CODEC) encodes and decodes digital audio data on the system.
CMOS	Complimentary metal-oxide-conductor is a type of integrated circuit used in chips like static RAM and microprocessors.
COM	COM is used to refer to serial ports. Serial ports offer serial communication to expansion devices. The serial port on a personal

WAFER-BT

	computer is usually a male DE-9 connector.
DAC	The Digital-to-Analog Converter (DAC) converts digital signals to analog signals.
DDR	Double Data Rate refers to a data bus transferring data on both the rising and falling edges of the clock signal.
DMA	Direct Memory Access (DMA) enables some peripheral devices to bypass the system processor and communicate directly with the system memory.
DIMM	Dual Inline Memory Modules are a type of RAM that offer a 64-bit data bus and have separate electrical contacts on each side of the module.
EHCI	The Enhanced Host Controller Interface (EHCI) specification is a register-level interface description for USB 2.0 Host Controllers.
GbE	Gigabit Ethernet (GbE) is an Ethernet version that transfers data at 1.0 Gbps and complies with the IEEE 802.3-2005 standard.
GPIO	General purpose input
IrDA	Infrared Data Association (IrDA) specify infrared data transmission protocols used to enable electronic devices to wirelessly communicate with each other.
L1 Cache	The Level 1 Cache (L1 Cache) is a small memory cache built into the system processor.
L2 Cache	The Level 2 Cache (L2 Cache) is an external processor memory cache.
LVDS	Low-voltage differential signaling (LVDS) is a dual-wire, high-speed differential electrical signaling system commonly used to connect LCD displays to a computer.
MAC	The Media Access Control (MAC) protocol enables several terminals or network nodes to communicate in a LAN, or other multipoint networks.

PCIe	PCI Express (PCIe) is a communications bus that uses dual data lines for full-duplex (two-way) serial (point-to-point) communications between the SBC components and/or expansion cards and the SBC chipsets. Each line has a 2.5 Gbps data transmission rate and a 250 MBps sustained data transfer rate.
POST	The Power-on Self Test (POST) is the pre-boot actions the system performs when the system is turned-on.
QVGA	Quarter Video Graphics Array (QVGA) refers to a display with a resolution of 320 x 240 pixels.
RAM	Random Access Memory (RAM) is a form of storage used in computer. RAM is volatile memory, so it loses its data when power is lost. RAM has very fast data transfer rates compared to other storage like hard drives.
SATA	Serial ATA (SATA) is a serial communications bus designed for data transfers between storage devices and the computer chipsets. The SATA bus has transfer speeds up to 1.5 Gbps and the SATA 3Gb/s bus has data transfer speeds of up to 3.0 Gbps.
S.M.A.R.T	Self Monitoring Analysis and Reporting Technology (S.M.A.R.T) refers to automatic status checking technology implemented on hard disk drives.
UART	Universal Asynchronous Receiver-transmitter (UART) is responsible for asynchronous communications on the system and manages the system's serial communication (COM) ports.
UHCI	The Universal Host Controller Interface (UHCI) specification is a register-level interface description for USB 1.1 Host Controllers.
USB	The Universal Serial Bus (USB) is an external bus standard for interfacing devices. USB 1.1 supports 12Mbps data transfer rates, while

WAFER-BT

USB 2.0 supports 480Mbps data transfer rates.

VGA

The Video Graphics Array (VGA) is a graphics display system developed by IBM.

Appendix

E

Digital I/O Interface

WAFER-BT

The DIO connector on the WAFER-BT is interfaced to GPIO ports on the Super I/O chipset. The DIO has both 8-bit digital inputs and 8-bit digital outputs. The digital inputs and digital outputs are generally control signals that control the on/off circuit of external devices or TTL devices. Data can be read or written to the selected address to enable the DIO functions.



NOTE:

For further information, please refer to the datasheet for the Super I/O chipset.

The BIOS interrupt call **INT 15H** controls the digital I/O.

INT 15H:

AH – 6FH	
<u>Sub-function:</u>	
AL – 8	:Set the digital port as INPUT
AL	:Digital I/O input value

Assembly Language Sample 1

```
MOV    AX, 6F08H      ;setting the digital port as input
INT    15H           ;
```

AL low byte = value

AH - 6FH
<u>Sub-function:</u>
AL - 9 :Set the digital port as OUTPUT
BL :Digital I/O output value

Assembly Language Sample 2

```
MOV    AX, 6F09H      ;setting the digital port as output  
MOV    BL, 09H        ;digital value is 09H  
INT    15H           ;
```

Digital Output is 1001b

Appendix

F

Watchdog Timer



NOTE:

The following discussion applies to DOS. Contact IEI support or visit the IEI website for drivers for other operating systems.

The Watchdog Timer is a hardware-based timer that attempts to restart the system when it stops working. The system may stop working because of external EMI or software bugs. The Watchdog Timer ensures that standalone systems like ATMs will automatically attempt to restart in the case of system problems.

A BIOS function call (INT 15H) is used to control the Watchdog Timer.

INT 15H:

AH – 6FH Sub-function:	
AL – 2:	Sets the Watchdog Timer's period.
BL:	Time-out value (Its unit-second is dependent on the item "Watchdog Timer unit select" in CMOS setup).

Table F-1: AH-6FH Sub-function

Call sub-function 2 to set the time-out period of Watchdog Timer first. If the time-out value is not zero, the Watchdog Timer starts counting down. When the timer value reaches zero, the system resets. To ensure that this reset condition does not occur, calling sub-function 2 must periodically refresh the Watchdog Timer. However, the watchdog timer is disabled if the time-out value is set to zero.

A tolerance of at least 10% must be maintained to avoid unknown routines within the operating system (DOS), such as disk I/O that can be very time-consuming.

WAFER-BT



NOTE:

The Watchdog Timer is activated through software. The software application that activates the Watchdog Timer must also deactivate it when closed. If the Watchdog Timer is not deactivated, the system will automatically restart after the Timer has finished its countdown.

EXAMPLE PROGRAM:

; INITIAL TIMER PERIOD COUNTER

;

W_LOOP:

;

```

MOV      AX, 6F02H      ;setting the time-out value
MOV      BL, 30         ;time-out value is 48 seconds
INT      15H

```

;

; ADD THE APPLICATION PROGRAM HERE

;

```

CMP      EXIT_AP, 1     ;is the application over?
JNE      W_LOOP        ;No, restart the application

MOV      AX, 6F02H     ;disable Watchdog Timer
MOV      BL, 0         ;
INT      15H

```

;

; EXIT ;

Appendix

G

Hazardous Materials Disclosure

WAFER-BT

The details provided in this appendix are to ensure that the product is compliant with the Peoples Republic of China (China) RoHS standards. The table below acknowledges the presences of small quantities of certain materials in the product, and is applicable to China RoHS only.

A label will be placed on each product to indicate the estimated “Environmentally Friendly Use Period” (EFUP). This is an estimate of the number of years that these substances would “not leak out or undergo abrupt change.” This product may contain replaceable sub-assemblies/components which have a shorter EFUP such as batteries and lamps. These components will be separately marked.

Please refer to the following table.

Part Name	Toxic or Hazardous Substances and Elements					
	Lead (Pb)	Mercury (Hg)	Cadmium (Cd)	Hexavalent Chromium (CR(VI))	Polybrominated Biphenyls (PBB)	Polybrominated Diphenyl Ethers (PBDE)
Housing	O	O	O	O	O	O
Display	O	O	O	O	O	O
Printed Circuit Board	O	O	O	O	O	O
Metal Fasteners	O	O	O	O	O	O
Cable Assembly	O	O	O	O	O	O
Fan Assembly	O	O	O	O	O	O
Power Supply Assemblies	O	O	O	O	O	O
Battery	O	O	O	O	O	O

O: This toxic or hazardous substance is contained in all of the homogeneous materials for the part is below the limit requirement in SJ/T11363-2006 (now replaced by GB/T 26572-2011).

X: This toxic or hazardous substance is contained in at least one of the homogeneous materials for this part is above the limit requirement in SJ/T11363-2006 (now replaced by GB/T 26572-2011).

此附件旨在确保本产品符合中国 RoHS 标准。以下表格标示此产品中某有毒物质的含量符合中国 RoHS 标准规定的限量要求。

本产品上会附有“环境友好使用期限”的标签，此期限是估算这些物质“不会有泄漏或突变”的年限。本产品可能包含有较短的环境友好使用期限的可替换元件，像是电池或灯管，这些元件将会单独标示出来。

部件名称	有毒有害物质或元素					
	铅 (Pb)	汞 (Hg)	镉 (Cd)	六价铬 (CR(VI))	多溴联苯 (PBB)	多溴二苯 醚 (PBDE)
壳体	O	O	O	O	O	O
显示	O	O	O	O	O	O
印刷电路板	O	O	O	O	O	O
金属螺帽	O	O	O	O	O	O
电缆组装	O	O	O	O	O	O
风扇组装	O	O	O	O	O	O
电力供应组装	O	O	O	O	O	O
电池	O	O	O	O	O	O

O: 表示该有毒有害物质在该部件所有物质材料中的含量均在 SJ/T 11363-2006 (现由 GB/T 26572-2011 取代) 标准规定的限量要求以下。

X: 表示该有毒有害物质至少在该部件的某一均质材料中的含量超出 SJ/T 11363-2006 (现由 GB/T 26572-2011 取代) 标准规定的限量要求。