

CS-115/P2102E

15" TFT-LCD Sunlight Readable, Modular and Expandable Panel PC with 8th Gen. Intel® Core™ U Series Processor

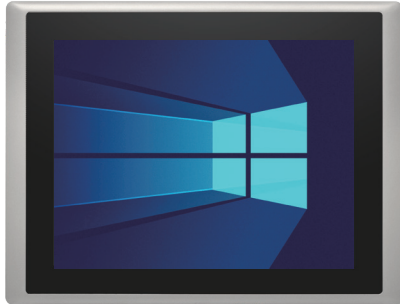

- 15" TFT-LCD with Ultra-high Brightness up to 1,600 nits and 1024 x 768 (XGA) Resolution
- Onboard 8th Generation Intel® Core™ U Series Processor
- 2x DDR4 SO-DIMM Socket, Supports Up to 2400MHz, 64GB
- Supports Triple Independent Display
- Integrated USB 3.2 Gen 2 supports up to 10Gbps
- M.2 E Key Socket for Wireless Module or Intel CRF Module
- Supports Ignition Sensing Function (IGN) (with optional CFM module)
- Supports 2x PoE+ Function (with optional CFM module)
- 1x PCI or 1x PCIe Slot for Add-on Card Expansion: Max. Length 180mm (with optional riser card)
- Wide Range Operating Temperature -20°C to 70°C
- Designed with Rugged Aluminum Die-casting Front Bezel
- True Flat IP65 Compliant Front Panel Protection
- Supports Panel / VESA / Rack Mounting
- Supports Optical Bonding



Overview

The CS-115/P2102E is a 15" TFT-LCD sunlight readable panel PC that offers sufficient screen brightness for better image quality in outdoor usage. The panel PC is powered by Intel® 8th generation Core™ U series processor that brings outstanding computing performance boost up to 84% at a TDP of 15 watts, compared to 6th generation Intel® Core™ U series. To enable faster responsiveness and deal with multi tasks with ease, the CS-115/P2102E is equipped with two DDR4 2400 SODIMM sockets for up to 64 GB memory.

For expansion requirements, the CS-115/P2102E has 1x PCI/PCIe x4, 1x M.2 2230 E key and 2x full-size Mini-PCIe expansions which can be installed various add-on cards to increase desired functions. Besides, the CS-115/P2102E supports Control Function Module (CFM) Technology to install optional CFM modules for increasing power over ethernet and power ignition sensing functions according to user's specific applications. Featuring rigorous industrial protections, wide range operating temperature (-20°C to 70°C), IP65 dust/waterproof front panel, and wide range DC power input (9 to 48VDC), the CS-115/P2102E is appropriate for tough outdoor applications under direct sunlight.

Furthermore, the CS-115/P2102E supports Cincoze patented Convertible Display System (CDS) technology, allowing users to replace display module or computer module on-site easily and thereby reducing maintenance costs and downtime.

Highlights

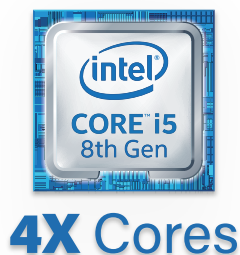

High Performance Per Watt

Powered by 8th generation Intel® Core™ U series processor (up to 4 cores, 4.10 GHz) at a TDP of only 15W, the CS-115/P2102E can fulfill a variety of applications that require high-performance computing and low power budget simultaneously.



Sunlight Readable

Featuring ultra-high brightness 1,600 nits, resolution up to 1024 x 768 (XGA), and optical bonding technology, the CS-115/P2102E provides excellent viewing experience under all lighting conditions including direct sunlight.



Built For Extreme Temperature

Built with wide operating temperature ranges and a special selection of industrial-grade components, the CS-115/P2102E is suitable for deploying under extreme environments and severe climate.

Specifications

Display

- LCD Size: 15" (4:3)
- Max. Resolution: 1024 x 768
- Brightness (cd/m2): 1600
- Contrast Ratio: 800 : 1
- LCD Color: 16.2M
- Pixel Pitch (mm): 0.297 (H) x 0.297 (V)
- Viewing Angle (H-V): 160 / 150
- Backlight MTBF: 50000 hrs (LED Backlight)

Touch

- Projected Capacitive Touch

Processor System

- Onboard 8th Intel® Core™ U Processors (Whiskey Lake)
 - Intel® Core™ i5-8365UE Quad Core Processor (6M Cache, up to 4.10 GHz)
 - Intel® Core™ i3-8145UE Dual Core Processor (4M Cache, up to 3.90 GHz)
 - TDP: 15 W

Memory

- 2x DDR4 2400 MHz 260-Pin SO-DIMM Socket
- Supports up to 64 GB (un-buffered and non-ECC)

Graphics

- Integrated Intel® UHD Graphics 620
- Supports Triple Independent Display (via VGA and DisplayPort Outputs)

Audio Codec

- Realtek ALC888-GR

External I/O Interface

- 1x VGA (1920 x 1200 @60Hz)
- 1x DisplayPort (4096 x 2304 @ 60Hz)
- 2x GbE LAN (Supports WoL, Teaming, Jumbo Frame & PXE), RJ45
 - GbE1: Intel® I219-LM
 - GbE2: Intel® I210-IT
- 3x USB 3.2 Gen2 (Type A)
- 2x USB 2.0 (Type A)
- 4x RS-232/422/485 with Auto Flow Control (Supports 5V/12V), DB9
- 1x Speaker-out & 1x Mic-in, Phone Jack 3.5mm
- 1x ATX Power On/Off Button
- 1x Reset Button
- 1x AT/ATX Mode Switch
- 1x Clear CMOS Switch
- 1x Remote Power On/Off Connector, 2-pin Terminal Block
- 16x Isolated DIO (8x DI/8x DO), 20-Pin Terminal Block
- 1x Ignition DIP Switch (12V/24V, need to work with CFM module)

Storage

- 2x 2.5" HDD/SSD Drive Bay (SATA 3.0), Supports RAID 0/1

Expansion

- 2x Full-size Mini-PCIe Socket
- 1x M.2 2230 E Key Socket for Wireless Module, Supports Intel CRF Module
- 2x Control Function Module (CFM) Interface
- 1x PCI or 1x PCIe x4 Expansion slot (with Optional Riser Card)
- 2x Universal I/O Bracket
- 1x Front Accessible SIM Socket
- 4x Antenna Hole

Other Functions

- Watchdog Timer: Software Programmable Supports 256 Levels System Reset
- Internal Speaker AMP 2W + 2W
- OSD Function: LCD On/Off, Brightness Up, Brightness Down
- SuperCap Integrated for CMOS Battery Maintenance-free Operation
- Supports Instant Reboot Technology (0.2 sec)

Power Requirement

- Supports AT/ATX Power Type
- Power Input Voltage 9~48VDC
- 1x 3-pin Terminal Block
- Power Adapter (Optional): AC/DC 24V/5A 120W or AC/DC 24V/9.2A 220W

Physical

- Dimension (WxDxH, mm): 408 x 312.4 x 91.5 mm
- Weight: 7.1 kg
- Construction: Rugged Aluminum Die-casting Front Bezel and Heavy Duty Metal Chassis
- Mounting: Panel / VESA / *Rack Mounting (*with optional mounting kit)
- Fanless Design
- Jumper-less Design

Environment

- Operating Temperature: -20°C to 70°C (with Extended Temperature Peripherals; Ambient with Air Flow)
- Storage Temperature: -20°C to 70°C
- Relative Humidity: 80% RH @ 40°C (Non-condensing)
- Shock: Operating, 15 Grms, Half-sine 11 ms Duration (w/ SSD, according to IEC60068-2-27)
- Vibration: Operating, 1.5 Grms, 5-500 Hz, 3 Axes (w/ SSD, according to IEC60068-2-64)
- IP Level: IP65 Compliant Front Panel
- EMC: CE, FCC Class A

Protection

- Reverse Power Input Protection
- Over Voltage Protection: 58V
- Over Current Protection: 15A
- ESD Protection: +/-15kV (air), +/-8kV (contact)
- Surge Protection: 3.84 kV (impedance 12 ohm 1.2/50µs waveform)

Operating System

- Windows® 10
- Linux: Supports by project

External Layout

Front I/O

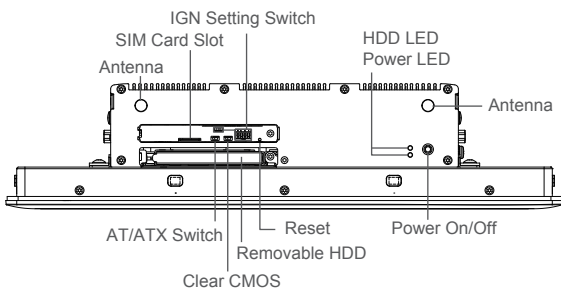

Rear I/O

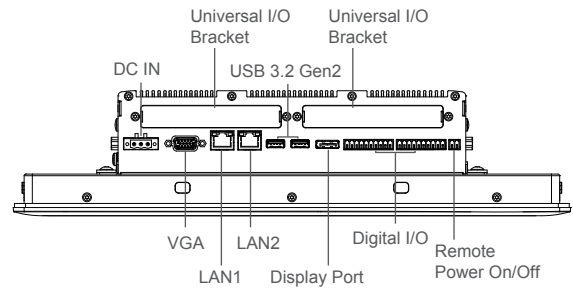

Left I/O

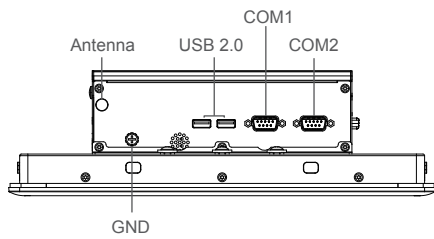

Right I/O

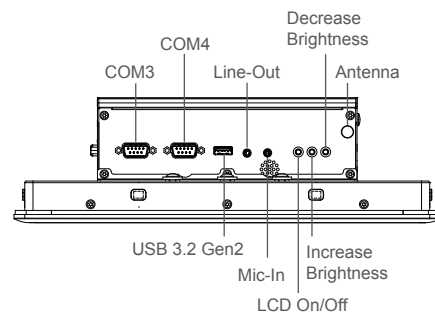

Dimensions

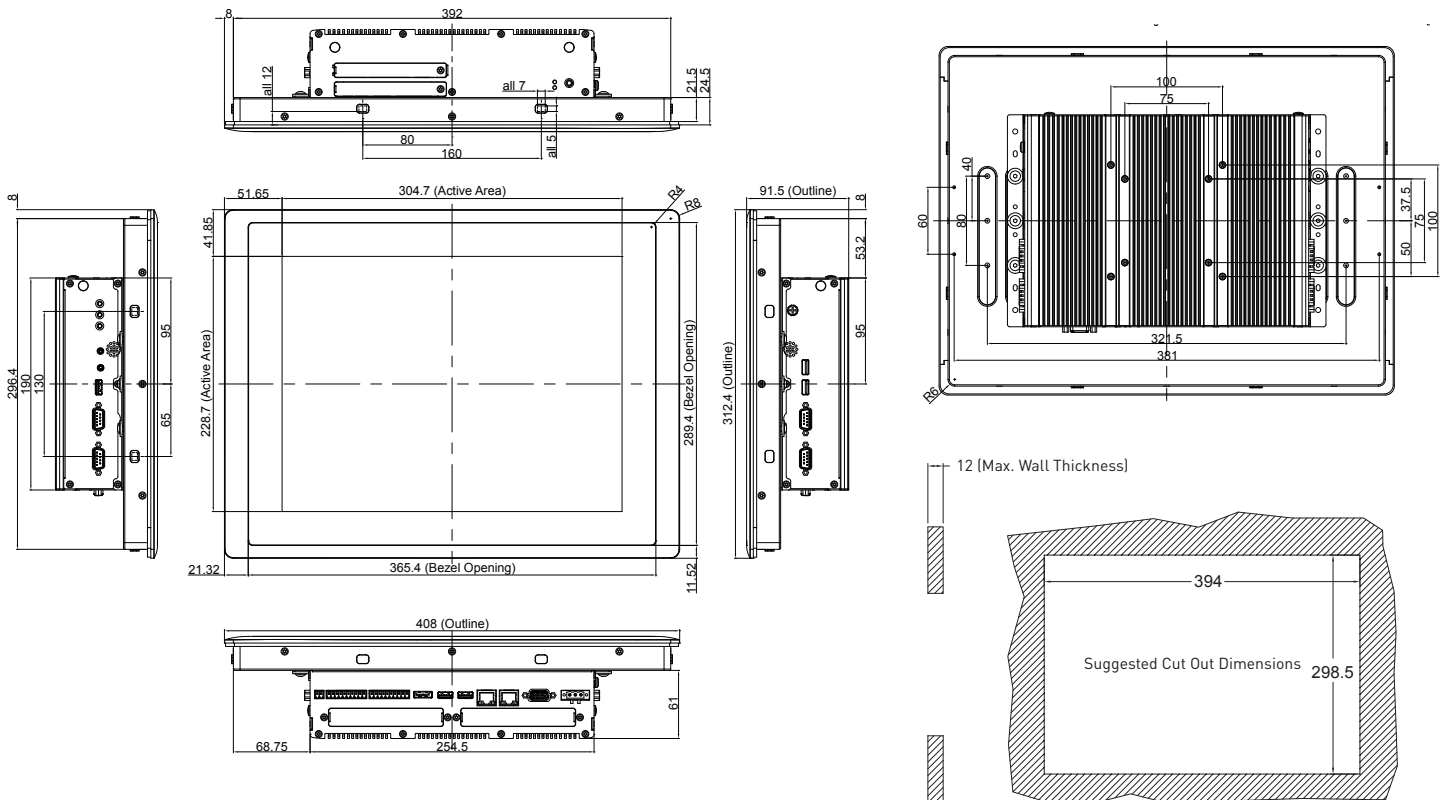

Unit: mm

Ordering Information

Available Models

Model No.	Description
CS-115C-R11/P2102E-i5-R10	15" 1600nits TFT-LCD Sunlight Readable, Modular and Expandable Panel PC with 8th Gen. Intel Core i5-8365UE Quad Core Processor and P-Cap. Touch
CS-115C-R11/P2102E-i3-R10	15" 1600nits TFT-LCD Sunlight Readable, Modular and Expandable Panel PC with 8th Gen. Intel Core i3-8145UE Quad Core Processor and P-Cap. Touch
CS-115C-OB-R11/P2102E-i5-R10	15" 1600nits TFT-LCD Sunlight Readable, Modular and Expandable Panel PC with 8th Gen. Intel Core i5-8365UE Quad Core Processor, P-Cap. Touch and Optical Bonding
CS-115C-OB-R11/P2102E-i3-R10	15" 1600nits TFT-LCD Sunlight Readable, Modular and Expandable Panel PC with 8th Gen. Intel Core i3-8145UE Quad Core Processor, P-Cap. Touch and Optical Bonding

Package Checklist

- CS-115/P2102E Panel PC x 1
- Thermal Pad (for CPU Thermal Block) x 1
- Power Terminal Block Connector x 1
- Remote Power On/Off Terminal Block Connector x 1
- DIO Terminal Block Connector x 2
- Utility Driver DVD x 1
- Screws Pack x 5
- Panel Mounting Kit x 1
- PCI / PCIe Card Installation Kit x 1

Optional Modules & Accessories

Model No.	Description
CFM-IGN101	CFM Module with Power Ignition Sensing Control Function, 12V/24V Voltage Detection Selectable
CFM-PoE05	CFM Module with PoE Control Function, Individual Port 25.5W
RC-E4-02	Riser Card with 1x PCIe x4 Slot for P2102E
RC-PI-02	Riser Card with 1x PCI Slot for P2102E
MEC-COM-M212-TDB9/UB1203	Mini-PCIe Module with 2x RS-232 Ports, 1x Thin DB9 Cable / 1x Universal Bracket with 2x DB9 Cutout for P2102E
MEC-COM-M334-TDB9/2xUB1203	Mini-PCIe Module with 4x RS-232/422/485 Ports, 2x Thin DB9 Cable / 2x Universal Bracket each with 2x DB9 Cutout for P2102E
MEC-USB-M102-30/UB1214	Mini-PCIe Module with 2x USB 3.0 Ports, 1x 30cm cable / 1x Universal Bracket with 2x USB Cutout for P2102E
MEC-LAN-M002-30/UB1211	Mini-PCIe Module with 2x LAN Ports, 2x 30cm cable / 1x Universal Bracket with 2x RJ45 Cutout for P2102E
GST120A24-CIN	Adapter AC/DC 24V 5A 120W, GST120A24-CIN, wide temp (-30°C ~ +70°C), level VI
GST220A24-CIN	Adapter AC/DC 24V 9.2A 220W with 3pin Terminal Block Plug 5.0mm Pitch, with TUBES, level VI
SL2-SL3	US 2 heads power cord, US B type to IEC C13, SVT 18AWG/3C Black 1.8M SL-2+SL-3
SL6-SL3	EU 2 heads power cord, EU G type to IEC C13, H05VV-F 0.75mm ² /3G Black 1.8M SL-6+SL-3
QP026-SL3	UK 2 heads power cord, UK I type to IEC C13, H05VV-F 0.75mm ² /3G Black 1.8M QP026+SL-3
URM01	Universal 19" Rack Mount Kit for Industrial Panel PC & Industrial Monitor

Optional Module Configuration

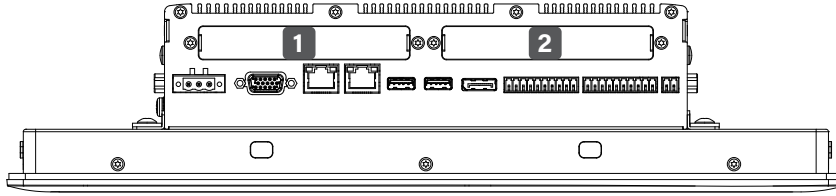

Model No.	Description	1	2
RC-E4-02	Riser Card with 1x PCIe x4 Slot for P2102E	V	-
RC-PI-02	Riser Card with 1x PCI Slot for P2102E	V	-
MEC-COM-M212-DB9/UB1203	Mini-PCIe Module with 2x RS-232 Ports, 1x Thin DB9 Cable / 1x Universal Bracket with 2x DB9 Cutout for P2102E	V	V
MEC-COM-M334-TDB9/2xUB1203	Mini-PCIe Module with 4x RS-232/422/485 Ports, 2x Thin DB9 Cable / 2x Universal Bracket each with 2x DB9 Cutout for P2102E	V	V
MEC-USB-M102-30/UB1214	Mini-PCIe Module with 2x USB 3.0 Ports, 1x 30cm cable / 1x Universal Bracket with 2x USB Cutout for P2102E	V	V
MEC-LAN-M002-30/UB1211	Mini-PCIe Module with 2x LAN Ports, 2x 30cm cable / 1x Universal Bracket with 2x RJ45 Cutout for P2102E	V	V

V : Compatible