

---

# COM Express™ conga-X7/EVAL

Detailed description of the congatec COM Express™ Type 7 evaluation carrier board

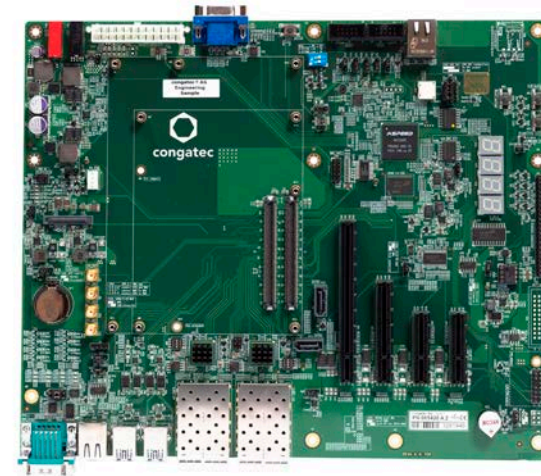

## *User's Guide*

Revision 1.1

# Revision History

---

Revision	Date (yyyy.mm.dd)	Author	Changes
1.0	2017.06.02	AEM	<ul style="list-style-type: none"><li>• Official release</li></ul>
1.1	2018.12.21	AEM	<ul style="list-style-type: none"><li>• Corrected the number of Ethernet interfaces supported in table 1 "conga-X7/Eval Variants"</li><li>• Updated section 4.1.5 "Baseboard Management Controller (BMC)"</li><li>• Changed the product image on the title page and in section 2 "Connector Layout"</li><li>• Updated the connector type for connector X49 in section 6.5 "Feature Connector"</li></ul>

---

# Preface

---

This user's guide provides information about the components, features and connectors available on the congatec COM Express™ Type 7 evaluation carrier board.

## Disclaimer

The information contained within this user's guide, including but not limited to any product specification, is subject to change without notice.

congatec AG provides no warranty with regard to this user's guide or any other information contained herein and hereby expressly disclaims any implied warranties of merchantability or fitness for any particular purpose with regard to any of the foregoing. congatec AG assumes no liability for any damages incurred directly or indirectly from any technical or typographical errors or omissions contained herein or for discrepancies between the product and the user's guide. In no event shall congatec AG be liable for any incidental, consequential, special, or exemplary damages, whether based on tort, contract or otherwise, arising out of or in connection with this user's guide or any other information contained herein or the use thereof..

## Intended Audience

This user's guide is intended for technically qualified personnel. It is not intended for general audiences.

## Lead-Free Designs (RoHS)

All congatec AG designs are created from lead-free components and are completely RoHS compliant.

## Electrostatic Sensitive Device



All congatec AG products are electrostatic sensitive devices. They are enclosed in static shielding bags, and shipped enclosed in secondary packaging (protective packaging). The secondary packaging does not provide electrostatic protection.

Do not remove the device from the static shielding bag or handle it, except at an electrostatic-free workstation. Also, do not ship or store electronic devices near strong electrostatic, electromagnetic, magnetic, or radioactive fields unless the device is contained within its original packaging. Be aware that failure to comply with these guidelines will void the congatec AG Limited Warranty

---

## Symbols

The following symbols are used in this user's guide:



### **Warning**

*Warnings indicate conditions that, if not observed, can cause personal injury.*



### **Caution**

*Cautions warn the user about how to prevent damage to hardware or loss of data.*



### **Note**

*Notes call attention to important information that should be observed.*



### **Connector Type**

*Describes the connector that must be used with the congatec COM Express™ evaluation carrier board, not the connector found on the congatec COM Express™ evaluation carrier board.*



### **Link to connector layout diagram**

*This link icon is located in the top left corner of each page. It provides a direct link to the connector layout diagram on page 8 of this document.*

## Copyright Notice

Copyright © 2017, congatec AG. All rights reserved. All text, pictures and graphics are protected by copyrights. No copying is permitted without written permission from congatec AG.

congatec AG has made every attempt to ensure that the information in this document is accurate yet the information contained within is supplied "as-is".

---

## Trademarks

Product names, logos, brands, and other trademarks featured or referred to within this user's guide, or the congatec website, are the property of their respective trademark holders. These trademark holders are not affiliated with congatec AG, our products, or our website.

## Warranty

congatec AG makes no representation, warranty or guaranty, express or implied regarding the products except its standard form of limited warranty ("Limited Warranty") per the terms and conditions of the congatec entity, which the product is delivered from. These terms and conditions can be downloaded from [www.congatec.com](http://www.congatec.com). congatec AG may in its sole discretion modify its Limited Warranty at any time and from time to time.

The products may include software. Use of the software is subject to the terms and conditions set out in the respective owner's license agreements, which are available at [www.congatec.com](http://www.congatec.com) and/or upon request.

Beginning on the date of shipment to its direct customer and continuing for the published warranty period, congatec AG represents that the products are new and warrants that each product failing to function properly under normal use, due to a defect in materials or workmanship or due to non conformance to the agreed upon specifications, will be repaired or exchanged, at congatec's option and expense.

Customer will obtain a Return Material Authorization ("RMA") number from congatec AG prior to returning the non conforming product freight prepaid. congatec AG will pay for transporting the repaired or exchanged product to the customer.

Repaired, replaced or exchanged product will be warranted for the repair warranty period in effect as of the date the repaired, exchanged or replaced product is shipped by congatec, or the remainder of the original warranty, whichever is longer. This Limited Warranty extends to congatec's direct customer only and is not assignable or transferable.

Except as set forth in writing in the Limited Warranty, congatec makes no performance representations, warranties, or guarantees, either express or implied, oral or written, with respect to the products, including without limitation any implied warranty (a) of merchantability, (b) of fitness for a particular purpose, or (c) arising from course of performance, course of dealing, or usage of trade.

congatec AG shall in no event be liable to the end user for collateral or consequential damages of any kind. congatec shall not otherwise be liable for loss, damage or expense directly or indirectly arising from the use of the product or from any other cause. The sole and exclusive remedy against congatec, whether a claim sound in contract, warranty, tort or any other legal theory, shall be repair or replacement of the product only.

## Certification



congatec AG is certified to DIN EN ISO 9001 standard.



---

## Technical Support

congatec AG technicians and engineers are committed to providing the best possible technical support for our customers so that our products can be easily used and implemented. We request that you first visit our website at [www.congatec.com](http://www.congatec.com) for the latest documentation, utilities and drivers, which have been made available to assist you. If you still require assistance after visiting our website then contact our technical support department by email at [support@congatec.com](mailto:support@congatec.com)

## Terminology

Term	Description
PCIe	Peripheral Component Interface Express (PCI Express)
SDIO	Secure Digital Input Output
USB	Universal Serial Bus
SATA	Serial AT Attachment
NCSI	Network Controller Sideband Interface
HDA	High Definition Audio
I <sup>2</sup> C Bus	Inter-Integrated Circuit Bus
SM Bus	System Management Bus
GBE	Gigabit Ethernet
LVDS	Low Voltage Differential Signaling
DDC	Display Data Channel
N.C	Not connected
N.A	Not available
T.B.D	To be determined

# Contents

1	Introduction .....	9	4.1.9	PCI Express® Connectors .....	30
1.1	COM Express™ Concept.....	9	5	Subsystems of Connector Rows C - D .....	31
1.2	conga-X7/EVAL .....	9	5.1	PCI Express® Connector.....	33
1.2.1	Options Information.....	10	5.2	10 Gigabit Ethernet (GbE) .....	33
2	Connector Layout .....	11	5.3	Configurable I/O Pins .....	34
3	Specifications .....	12	5.4	Management Interface for PHY and MAC .....	34
3.1	Mechanical Dimensions .....	12	6	Additional Features.....	35
3.2	Environmental Specifications .....	12	6.1	Buttons.....	35
3.3	Power Supply .....	12	6.1.1	Power .....	35
3.3.1	ATX Power Supply .....	12	6.1.2	Reset .....	35
3.3.2	DC Power Supply (12V).....	14	6.1.3	LID.....	35
3.3.3	Status LEDs D32-D36.....	15	6.1.4	Sleep .....	35
3.3.4	PWR_OK Signal.....	15	6.2	PC Speaker .....	36
3.3.5	Power-Up Control .....	16	6.3	Debug Display .....	36
3.3.6	Power Consumption Measurement .....	16	6.4	Ground Test Points.....	37
3.3.7	Module Type Detection .....	16	6.5	Feature Connector .....	37
3.4	CMOS Battery.....	17	6.6	CPLD Programming Header - Internal Use Only .....	38
4	Subsystems of Connector Rows A - B.....	18	6.7	cBC Programming Header - Internal Use Only .....	39
4.1	Communication Buses .....	20	6.8	BMC Configuration Jumpers .....	39
4.1.1	SM Bus .....	20	7	Mechanical Dimensions .....	40
4.1.2	I <sup>2</sup> C Bus.....	20	8	Industry Specifications .....	41
4.1.3	SPI Bus .....	21			
4.1.4	LPC Bus.....	22			
4.1.5	Baseboard Management Controller (BMC) .....	22			
4.1.5.1	VGA Display .....	23			
4.1.5.2	UART .....	24			
4.1.5.3	RJ45 Gigabit Ethernet Interface .....	26			
4.1.6	Fan Control .....	27			
4.1.7	Universal Serial Bus (USB) .....	28			
4.1.8	SATA™ .....	28			
4.1.8.1	SATA Interfaces.....	28			
4.1.8.2	SATA Power .....	29			
4.1.8.3	SATA-DOM Power .....	29			

# List of Tables

Table 1	conga-X7/EVAL Variants .....	10
Table 2	Jumper X55 Pinout Description .....	13
Table 3	Jumper X58 Pinout Description .....	13
Table 4	ATX Power (Connector X54) Pinout Description .....	13
Table 5	DC Power Connectors - M23 and M24 .....	14
Table 6	Power LEDs Status .....	15
Table 7	Jumper X56 Pinout Description .....	15
Table 8	Pin Header X3 / X4 Pinout Description .....	16
Table 9	Module Type Detection Pinout Description .....	16
Table 10	Jumper X48 Pinout Description .....	17
Table 11	Module Type 7 Connector Pinout—Rows A and B .....	18
Table 12	DIP Switch M16 Pinout Description .....	21
Table 13	SPI Jumper (X45, X46, X47) Pinout Description .....	21
Table 14	Connector CN1 Pinout Description .....	22
Table 15	Connector X25 Pinout Description .....	23
Table 16	Jumper X26 Pinout Description .....	23
Table 17	COM Port - Connector X41 Pinout Description .....	24
Table 18	Possible Serial Port Configuration .....	24
Table 19	Pin Header X44 Pinout Description .....	25
Table 20	Jumper X43 Pinout Description .....	25
Table 21	LAN X19 / X32 Pinout Description .....	26
Table 22	Jumper X20 Pinout Description .....	26
Table 23	Fan (Connector X51) Pinout Description .....	27
Table 24	Jumper X50 Pinout Description .....	27
Table 25	Jumper X18 Pinout Description .....	28
Table 26	Header X15 Pinout Description .....	28
Table 27	Connector X14 Pinout Description .....	29
Table 28	Module Type 7 Connector Pinout—Rows C and D .....	31
Table 29	Pin Header X5 Pinout Description .....	34
Table 30	Jumper X60 Pinout Description .....	36
Table 31	Jumper X59 Pinout Description .....	36
Table 32	Feature Connector X49 Pinout Description .....	37



---

# 1 Introduction

---

## 1.1 COM Express™ Concept

COM Express™ is an open industry standard defined specifically for COMs (computer on modules). Its creation makes it possible to smoothly transition from legacy interfaces to the newest technologies available today.

A Computer On Module integrates all the core components and standard I/O interfaces of a common PC onto an application specific carrier board. The key advantage of the COM in the embedded computer industries is that all the highly integrated, high speed components such as CPU, chipsets and memory are combined on a small module form factor for easy adaptation into different applications across multiple market segments.

COM Express™ modules have standardized form factors and specified pinouts on the two system connectors that remain the same regardless of the vendor. The COM Express™ module reflects the functional requirements for a wide range of embedded applications. These functions include, but are not limited to, PCI Express, Graphics, High Definition Audio, parallel ATA, serial ATA, Gigabit Ethernet and USB ports. Two ruggedized, shielded connectors provide the carrier board interface and carry all the I/O signals to and from the COM Express™ module.

Carrier board designers can use as little or as many of the I/O interfaces as deemed necessary. The carrier board can therefore provide all the interface connectors required to attach the system to the application specific peripherals. This versatility allows the designer to create a dense and optimized package, which results in a more reliable product while simplifying system integration. Most importantly, COM Express™ modules are scalable, which means once an application has been created there is the ability to diversify the product range through the use of different performance class or form factor size modules. Simply unplug one module and replace it with another; no redesign is necessary.

## 1.2 conga-X7/EVAL

The conga-X7/EVAL carrier board is designed based on the Type 7 pinout definition and it complies with COM Express Specification 3.0. The conga-X7/EVAL provides most of the functional requirements for any application. These functions include, but are not limited to a rich complement of contemporary high bandwidth serial interfaces such as PCI Express, Serial ATA, USB 3.0/2.0, and Gigabit Ethernet. To ensure stable data throughput, the carrier board is equipped with two high performance connectors in accordance with the COM Express specification.

By combining the scalability of COM Express modules, the conga-X7/EVAL carrier board provides manufacturers and developers with a platform to jump-start the development of systems and applications based on COM Express specification. This helps to reduce product design cycle and encourages rapid innovation in system design, to meet the ever-changing needs of the market.

The various features and capabilities offered by the conga-X7/EVAL makes it ideal for the integration of Compact, Basic and Extended form factor CPU modules.



## 1.2.1 Options Information

The conga-X7/EVAL is available in two variants—commercial and industrial variants. The table below shows the different configurations available.

Table 1 conga-X7/EVAL Variants

Part-No.	065420	065421
Operational Temperature	Commercial	Industrial
Temperature Range	0°C to 60°C	-40°C to 85°C
Ethernet		
10 GB SFP+	4 x 10 GbE (Inphy CS4227)	4 x 10 GbE (Inphy CS4223E)
1 GB RJ45	1 x 1 GbE standard network interface 1 x BMC management interface	1 x 1 GbE standard network interface
Board Management Controller	Yes	No
PCIe	1 x16, 1 x8 and 2 x4 lanes	1 x16, 1 x8 and 2 x4 lanes
USB	4x USB 2.0/3.0	4x USB 2.0/3.0
SATA	2x Ports	2x Ports



## 2 Connector Layout

The connector layout picture below shows each connector and its name designator. Jumpers and their respective pins are also shown. Select the Adobe 'Zoom-In-Tool' and zoom in on a given component to see its designator. Hover over the component and the 'Zoom-In-Tool' will change indicating there is a link.

Click on the link to navigate to the area in the document where the component is described. Use the mouse icon in the top left hand corner of the destination page to return to the connector layout picture.

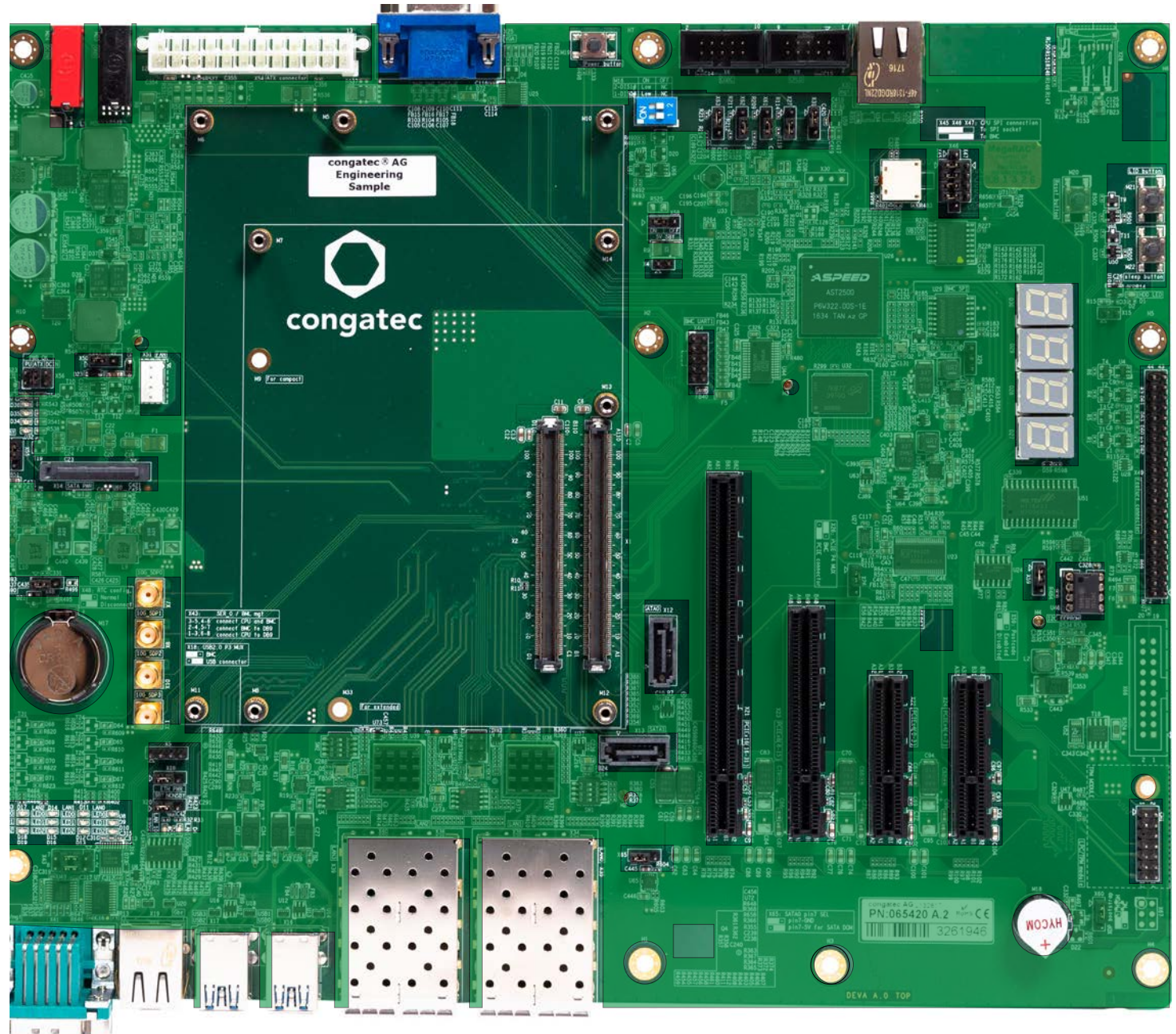



## 3 Specifications

### 3.1 Mechanical Dimensions

- 294.0 mm x 244.0 mm
- Height approximately 32.7 mm

### 3.2 Environmental Specifications

Temperature	Operation: 0°C to 60°C	Storage: -20° to +80°C (commercial temperature)
Temperature	Operation: -40°C to 85°C	Storage: -20° to +80°C (industrial temperature)
Humidity	Operation: 10% to 90%	Storage: 5% to 95%



#### Note

*The above operating temperatures must be strictly adhered to at all times. The maximum operating temperature refers to any measurable spot on the modules surface.*

*Humidity specifications are for non-condensing conditions.*

### 3.3 Power Supply

The conga-X7/EVAL supports two types of power supplies:

- standard 24 pin ATX (connector X54)
- 12 V DC power supply (connectors M23 and M24)

#### 3.3.1 ATX Power Supply

When using an ATX power supply, the COM Express™ module starts after the power-on button M19 is pressed (ATX mode). To configure the power supply to operate in AT mode, set jumper X55 to position 2-3. In this mode, the module starts after the power switch on the power supply is turned on.

With jumper X58, you can disconnect the 5V standby voltage from the whole system.



Table 2 Jumper X55 Pinout Description

Pin	Description
1-2	ATX power supply (default)
2-3	ATX power supply runs in AT mode

ATX/AT - Jumper X55



Pwr On (M19)

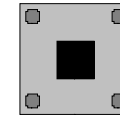

Table 3 Jumper X58 Pinout Description

Pin	Description
1-2	5V standby connected (default)
2-3	5V standby disconnected

Standby - Jumper X58



Table 4 ATX Power (Connector X54) Pinout Description

Pin	Signal	Description	Pin	Signal	Description
1	+3.3V	Power Supply +3.3VDC	13	+3.3V	Power Supply +3.3VDC
2	+3.3V	Power Supply +3.3VDC	14	-12V	Power Supply -12VDC
3	GND	Power Ground	15	GND	Power Ground
4	+5V	Power Supply +5VDC	16	PS_ON#	Power Supply On (active low). Short this pin to GND to switch power supply ON, disconnect from GND to switch OFF.
5	GND	Power Ground	17	GND	Power Ground
6	+5V	Power Supply +5VDC	18	GND	Power Ground
7	GND	Power Ground	19	GND	Power Ground
8	PWR_OK	Power Ok	20	N.C	
9	5V_SB	Standby Power Supply +5VDC	21	+5V	Power Supply +5VDC
10	+12V	Power Supply +12VDC	22	+5V	Power Supply +5VDC
11	+12V	Power Supply +12VDC	23	+5V	Power Supply +5VDC
12	+3.3V	Power Supply +3.3VDC	24	GND	Power Ground

ATX Power - Connector X54

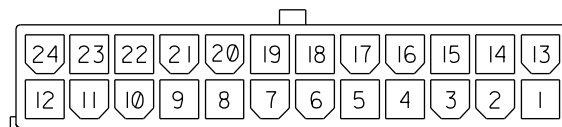



## Note

1. The -5V power output of the ATX power supply is not used.
2. congatec recommends to use a 24 pin ATX 2.0 compliant power supply.
3. In ATX mode, the +3.3 V and +5 V are derived from the ATX power supply. If a 12 V DC power supply is used via connectors M22 and M23, the onboard DC/DC regulator will generate the 3.3 V and 5 V.

## Connector Type

X54: 24-pin ATX 2.0 connector

X55, X58: 2.54mm, 1 x 3-pin header

## 3.3.2 DC Power Supply (12V)

You can also power the conga-X7/EVAL with a 12 V DC power supply, via connectors M22 and M23.

Table 5 DC Power Connectors - M23 and M24

Connector	Description
M23	Ground
M24	+12VDC (11,4 – 12,6V)

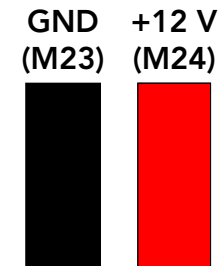

## Connector Type

M23,M24: 4mm diameter plug



### 3.3.3 Status LEDs D32-D36

The status LEDs indicate the different power states of the conga-X7/EVAL. An external power LED can be connected to pin header X54. Refer to the following table for detailed information.

Table 6 Power LEDs Status

LED	Status	Description
All	Off	No power applied.
All	On	ATX power supply is mechanically switched on, with stable 3.3 V, 5 V and 12 V.
D32	On	The green LED D32 indicates that the 3V standby power is applied to the conga-X7/EVAL
D33	On	The yellow LED D33 indicates that 5V standby power is applied to the conga-X7/EVAL. If only D33 is lit, it indicates that the ATX power supply is mechanically switched on and only 5 V standby power is applied to the conga-X7/EVAL
D34	On	The green LED D34 indicates that 12 V main power is present
D35	On	The green LED D35 indicates that 5 V main power is present
D36	On	Indicates that the main power rails are present. LED D34 indicates +12V; D35 indicates +5V and D36 indicates +3.3V.

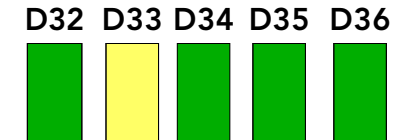

### 3.3.4 PWR\_OK Signal

The PWR\_OK signal is a high-active input from the main power supply to the module and it indicates whether the power is good. Jumper X56 provides the ability to configure the PWR\_Ok signal in different ways.

Table 7 Jumper X56 Pinout Description

Pin	Description
1 - 2	Add 3.3V pull-up with 1 kΩ to PWR_OK signal (for debug purposes)
3 - 4	Connect PWR_OK signal from ATX power supply. (default)
5 - 6	Connect PWR_OK signal from onboard DC/DC regulator

Jumper X56 - PWR\_OK Config

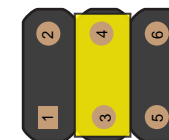

#### Connector Type

X56: 2.54mm, 2 x 3-pin header



### 3.3.5 Power-Up Control

The power-up control signal (PS\_ON) is responsible for switching the ATX power supply on or off. On congatec modules, the power-up circuit uses the SUS\_S3# signal to control the PS\_ON# signal, which subsequently switches the ATX power supply on or off. When using the SUS\_S3# signal the COM Express™ module is capable of supporting Suspend to RAM (S3).

When the system goes to Suspend to RAM (S3) or Soft Off (S5), the module's chipset asserts the 'SUS\_S3#' signal. Through the use of an inverter, the low active 'PS\_ON#' signal goes high and switches off the ATX power supply. Vice versa, if the system is in a power-down system state, any system wake-up event invokes the chipset of the module to deassert the 'SUS\_S3#' signal. This results in a system transition to Full On (S0).

### 3.3.6 Power Consumption Measurement

Use pin headers X3 and X4 to measure the power consumption of the COM Express module

Table 8 Pin Header X3 / X4 Pinout Description

X3	Configuration	X4	Configuration
1	VCC12V	1	VCC5V_SBY
2	VCC12V_COME	2	VCC5V_SBY_COME

Pin Header X3



Pin Header X4



#### Connector Type

X3,X4: 2.54mm, 1 x 2-pin header

### 3.3.7 Module Type Detection

The COM Express™ Specification defined four signals that indicate the pinout type of the module connected to the carrier board. The pins 'TYPE0#', 'TYPE1#', 'TYPE2#' and 'TYPE10#' are either left open (NC), strapped to ground (GND) or connected to 12 V by the module to encode the pinout type according to the following table. For more information, refer to the COM Express™ Specification.

Table 9 Module Type Detection Pinout Description

Module Type	Pin TYPE0#	Pin TYPE1#	Pin TYPE2#	Pin TYPE10#	Comment
Module Type 1	X (don't care)	X (don't care)	X (don't care)	12V / NC	COM Express Specification 1.0 / 2.0
Module Type 10	X (don't care)	X (don't care)	X (don't care)	47k PD	COM Express Specification 2.0
Module Type 2	NC	NC	NC	12V / NC	COM Express Specification 1.0 / 2.0





Module Type 3	NC	NC	GND	12V / NC	COM Express Specification 1.0 / 2.0
Module Type 4	NC	GND	NC	12V / NC	COM Express Specification 1.0 / 2.0
Module Type 5	NC	GND	GND	12V / NC	COM Express Specification 1.0 / 2.0
Module Type 6	GND	NC	NC	NC	COM Express Specification 2.0 / 3.0
Module Type 7	GND	N.C	GND	N.C	COM Express Specification 3.0

**Note**

If the conga-X7/EVAL detects an incompatible module pinout, an onboard logic prevents the board from powering up the whole system by controlling the 'PS\_ON#' signal of the ATX power supply.

### 3.4 CMOS Battery

The conga-X7/EVAL provides a board-mounted battery holder (M16) for CMOS battery. The CMOS battery supplies the necessary power required to maintain the module's RTC and CMOS memory. The specified battery type is CR2032.

#### M17 (Battery Holder)

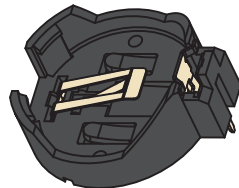

#### CMOS Battery



To disconnect the RTC battery, set jumper X48 to position 2-3.

Table 10 Jumper X48 Pinout Description

Pin	Description
1 - 2	Connect RTC battery (default)
2 - 3	Disconnect the RTC battery

#### Battery On/Off - Jumper X48

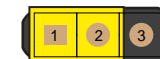

**Warning**

Danger of explosion if battery is incorrectly replaced. Replace only with the same or equivalent type recommended by the manufacturer. Dispose of used batteries according to the manufacturer's instructions.



## 4 Subsystems of Connector Rows A - B

Table 11 Module Type 7 Connector Pinout—Rows A and B

Pin	Row A	Pin	Row B	Pin	Row A	Pin	Row B
A1	GND (FIXED)	B1	GND (FIXED)	A56	PCIE_TX4-	B56	PCIE_RX4-
A2	GBE0_MDI3-	B2	GBE0_ACT#	A57	GND	B57	GPO2
A3	GBE0_MDI3+	B3	LPC_FRAME#/ESPI_CS0#	A58	PCIE_TX3+	B58	PCIE_RX3+
A4	GBE0_LINK100#	B4	LPC_AD0/ESPI_IO_0	A59	PCIE_TX3-	B59	PCIE_RX3-
A5	GBE0_LINK1000#	B5	LPC_AD1/ESPI_IO_1	A60	GND (FIXED)	B60	GND (FIXED)
A6	GBE0_MDI2-	B6	LPC_AD2/ESPI_IO_2	A61	PCIE_TX2+	B61	PCIE_RX2+
A7	GBE0_MDI2+	B7	LPC_AD3/ESPI_IO_3	A62	PCIE_TX2-	B62	PCIE_RX2-
A8	GBE0_LINK#	B8	LPC_DRQ0#/ESPI_ALERT0#	A63	GPI1	B63	GPO3
A9	GBE0_MDI1-	B9	LPC_DRQ1#/ESPI_ALERT1#	A64	PCIE_TX1+	B64	PCIE_RX1+
A10	GBE0_MDI1+	B10	LPC_CLK/ESPI_CK	A65	PCIE_TX1-	B65	PCIE_RX1-
A11	GND(FIXED)	B11	GND (FIXED)	A66	GND	B66	WAKE0#
A12	GBE0_MDI0-	B12	PWRBTN#	A67	GPI2	B67	WAKE1#
A13	GBE0_MDI0+	B13	SMB_CK	A68	PCIE_TX0+	B68	PCIE_RX0+
A14	GBE0_CTREF	B14	SMB_DAT	A69	PCIE_TX0-	B69	PCIE_RX0-
A15	SUS_S3#	B15	SMB_ALERT#	A70	GND (FIXED)	B70	GND (FIXED)
A16	SATA0_TX+	B16	SATA1_TX+	A71	PCIE_TX8+	B71	PCIE_RX8+
A17	SATA0_TX-	B17	SATA1_TX-	A72	PCIE_TX8-	B72	PCIE_RX8-
A18	SUS_S4#	B18	SUS_STAT#/ESPI_RESET#	A73	GND	B73	GND
A19	SATA0_RX+	B19	SATA1_RX+	A74	PCIE_TX9+	B74	PCIE_RX9+
A20	SATA0_RX-	B20	SATA1_RX-	A75	PCIE_TX9-	B75	PCIE_RX9-
A21	GND (FIXED)	B21	GND (FIXED)	A76	GND	B76	GND
A22	PCIE_TX15+	B22	PCIE_RX15+	A77	PCIE_TX10+	B77	PCIE_RX10+
A23	PCIE_TX15-	B23	PCIE_RX15-	A78	PCIE_TX10-	B78	PCIE_RX10-
A24	SUS_S5#	B24	PWR_OK	A79	GND	B79	GND
A25	PCIE_TX14+	B25	PCIE_RX14+	A80	GND (FIXED)	B80	GND (FIXED)
A26	PCIE_TX14-	B26	PCIE_RX14-	A81	PCIE_TX11+	B81	PCIE_RX11+
A27	BATLOW#	B27	WDT	A82	PCIE_TX11-	B82	PCIE_RX11-
A28	(S)ATA_ACT#	B28	RSVD	A83	GND	B83	GND
A29	RSVD	B29	RSVD	A84	NCSI_TX_EN	B84	VCC_5V_SBY



Pin	Row A	Pin	Row B	Pin	Row A	Pin	Row B
A30	RSVD	B30	RSVD	A85	GPI3	B85	VCC_5V_SBY
A31	GND (FIXED)	B31	GND (FIXED)	A86	RSVD	B86	VCC_5V_SBY
A32	RSVD	B32	SPKR	A87	RSVD	B87	VCC_5V_SBY
A33	RSVD	B33	I2C_CK	A88	PCIE_CK_REF+	B88	BIOS_DIS1#
A34	BIOS_DIS0#/ESPI_SAFS	B34	I2C_DAT	A89	PCIE_CK_REF-	B89	NCSI_RX_ER
A35	THRMTRIP#	B35	THRM#	A90	GND (FIXED)	B90	GND (FIXED)
A36	PCIE_TX13+	B36	PCIE_RX13+	A91	SPI_POWER	B91	NCSI_CLK_IN
A37	PCIE_TX13-	B37	PCIE_RX13-	A92	SPI_MISO	B92	NCSI_RXD1
A38	GND	B38	GND	A93	GPO0	B93	NCSI_RXD0
A39	PCIE_TX12+	B39	PCIE_RX12+	A94	SPI_CLK	B94	NCSI_CRS_DV
A40	PCIE_TX12-	B40	PCIE_RX12-	A95	SPI_MOSI	B95	NCSI_TXD1
A41	GND (FIXED)	B41	GND (FIXED)	A96	TPM_PP	B96	NCSI_TXD0
A42	USB2-	B42	USB3-	A97	TYPE10#	B97	SPI_CS#
A43	USB2+	B43	USB3+	A98	SER0_TX	B98	NCSI_ARB_IN
A44	USB_2_3_OC#	B44	USB_0_1_OC#	A99	SER0_RX	B99	NCSI_ARB_OUT
A45	USB0-	B45	USB1-	A100	GND (FIXED)	B100	GND (FIXED)
A46	USB0+	B46	USB1+	A101	SER1_TX	B101	FAN_PWMOUT
A47	VCC_RTC	B47	ESPI_EN#	A102	SER1_RX	B102	FAN_TACHIN
A48	RSVD	B48	USB0_HOST_PRSENT	A103	LID#	B103	SLEEP#
A49	GBE0_SDP	B49	SYS_RESET#	A104	VCC_12V	B104	VCC_12V
A50	LPC_SERIRQ/ESPI_CS1#	B50	CB_RESET#	A105	VCC_12V	B105	VCC_12V
A51	GND (FIXED)	B51	GND (FIXED)	A106	VCC_12V	B106	VCC_12V
A52	PCIE_TX5+	B52	PCIE_RX5+	A107	VCC_12V	B107	VCC_12V
A53	PCIE_TX5-	B53	PCIE_RX5-	A108	VCC_12V	B108	VCC_12V
A54	GPI0	B54	GPO1	A109	VCC_12V	B109	VCC_12V
A55	PCIE_TX4+	B55	PCIE_RX4+	A110	GND (FIXED)	B110	GND (FIXED)



## 4.1 Communication Buses

### 4.1.1 SM Bus

The SM Bus signals are available on the feature connector X49 described in section 6.8. These signals are powered on the COM Express module by the standby power rail in order to have control over the system during the system states S0-S5. The devices on the conga-X7/EVAL that use the SMB are powered by the 3.3 V main power. To avoid current leakage between the main power of the conga-X7/EVAL and the standby power of the module, the conga-X7/EVAL features a FET switch that separates its SMB from the SMB of the module.

### 4.1.2 I<sup>2</sup>C Bus

The I<sup>2</sup>C signals are available in different locations on the conga-X7/EVAL including on the feature connector X49 described in section 6.8. In addition, the conga-X7/EVAL includes socket P11 for an I<sup>2</sup>C EEPROM (U46) for test purposes during the system development. This 8-pin DIL socket can be used with various 2-wire serial EEPROMS (for example 24C04 / 24C08 / 24C16 and so on) and can be accessed by using the I<sup>2</sup>C control commands implemented in the congatec CGOS API driver. Refer to the user's guide of the COM Express™ module and the CGOS manual for more information.

#### I<sup>2</sup>C EEPROM Socket - P11

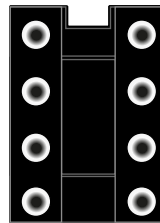

#### Connector Type

*P11: Standard 2 x 4-pin DIL socket*



### 4.1.3 SPI Bus

The conga-X7/EVAL offers the possibility to boot the COM Express™ CPU module using an external BIOS instead of the module's onboard BIOS. This feature is very useful when a customized BIOS must be evaluated. Use jumpers X45 and X46 for SPI communication between the module and the external flash on SOIC8 socket or jumpers X46 and X47 for SPI communication between the module and the BMC.

Located on the conga-X7/EVAL is a 8-pin SOIC8 socket for an SPI flash (socket U45). Use DIP switch M16 to configure which flash device the COM Express™ CPU module should boot from. The table below shows the available configurations.

Table 12 DIP Switch M16 Pinout Description

DIP Switch		Configuration
SW 1	SW 2	
OFF	OFF	Boot from on-module firmware (default)
OFF	ON	Boot from carrier board SPI Flash
ON	OFF	Not supported
ON	ON	Boot from on-module firmware, but load management data from carrier SPI

SOIC8 Socket - U45

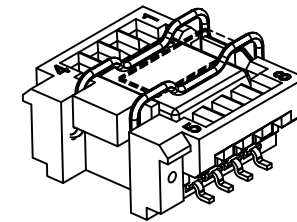

DIP Switch - M16

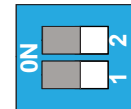
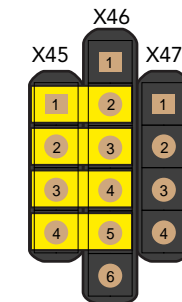

Table 13 SPI Jumper (X45, X46, X47) Pinout Description

Jumper X45		Jumper X46		Jumper X47		Configuration
Pin	Signals	Pin	Jumper X46	Pin	Jumper X47	
No pin	N.A	1	COMEx_SPI_PWR	No pin	N.A	Jumpers X45 and X46 for SPI communication between module and external flash on SOIC8 (default).
1	SOIC8_SPI_MOSI	2	COMEx_SPI_MOSI	1	BMC_SPI_MOSI	Jumpers X46 and X47 for SPI communication between module and BMC.
2	SOIC8_SPI_MISO	3	COMEx_SPI_MISO	2	BMC_SPI_MISO	
3	SOIC8_SPI_CS#	4	COMEx_SPI_CS#	3	BMC_SPI_CS#	
4	SOIC8_SPI_CLK	5	COMEx_SPI_CLK	4	BMC_SPI_CLK	
No pin	N.A	6	GND	No pin	N.A	

SPI Jumper



#### Connector Type

U45: SPI flash SOIC8 socket



## 4.1.4 LPC Bus

The LPC interface from the Type 7 module is routed to connector CN1 and to the BMC. Connector CN1—a 14-pin header—supports TPM modules that are compliant with the LPC specification.

Table 14 Connector CN1 Pinout Description

Pin	Signals	Pin	Signals
1	GND	2	LPC_FRAME#
3	LPC_CLK	4	LPC_AD3
5	KEY	6	LPC_AD2
7	SIO_RESET_BUF#	8	LPC_AD1
9	VCC3V3	10	LPC_AD0
11	NC	12	LPC_SERIRQ
13	VCC3V3_SBY	14	LPC_DRQ0#

### LPC/TPM Header - CN1

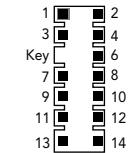

### Connector Type

CN1: 2.54 mm, 2 x 7-pin header

## 4.1.5 Baseboard Management Controller (BMC)

The BMC (Aspeed AST2500) on the conga-X7/EVAL is for proof of concept only. Carrier board designers can use it as a hardware design guide or to test the physical interfaces of system firmware (BIOS) or remote system management software. The BMC functionality is application-specific and not part of the COM Express Type 7 specification. The BMC firmware on the conga-X7/EVAL has the following limited feature set:

- VGA controller (built in AST2500 as PCIe endpoint)
- Super I/O UART
- IPMI system interface
- debug console for BMC
- BMC debug UART
- online GUI for remote access (shows only American Megatrend's logo and banner)



### 4.1.5.1 VGA Display

The conga-X7/EVAL supports one VGA interface (connector X25) via the BMC—providing display capability without an additional cost for VGA add-on-card. The VGA controller in the BMC supports the following:

- resolution up to 1920x1200 @ 60Hz and 32 bpp
- widescreen resolutions:
  - WXGA: 1280 x 800, 32 / 16 bpp @ 60 Hz
  - WXGA+: 1440 x 900, 32 / 16 bpp @ 60 Hz
  - WSXGA+: 1680 x 1050, 32 / 16 bpp @ 60 Hz
  - FullHD: 1920 x 1080p 32 / 16 bpp @ 60 Hz
- VESA-compliant DDC interfaces for the display monitor
- hot-plug detection

The VGA controller controls the graphic output via PCIe lane 4, which is shared with PCIe x4 slot (connector X24). Set jumper X26 to position 1-2 to select the VGA output or to position 2-3 to select the PCIe x4 slot.

Table 15 Connector X25 Pinout Description

Pin	Signal	Pin	Signal
1	RED	9	DDC Power
2	GREEN	10	GND
3	BLUE	11	N.C.
4	N.C.	12	DDC DAT
5	GND	13	HSYNC
6	GND	14	VSYNC
7	GND	15	DDC CLK
8	GND		

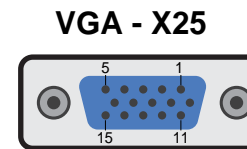
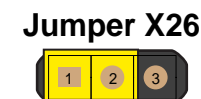

Table 16 Jumper X26 Pinout Description

Pin	Configuration
1-2	VGA support (default)
2-3	PCIe x4 support





## Note

The industrial variants do not feature the Board Management Controller.

## Connector Type

X25: 15-pin DSUB male connector

X26: 2.54 mm, 1 x 3-pin header

### 4.1.5.2 UART

The conga-X7/EVAL offers up to two RS-232 compliant serial ports via connector X41 (stacked dual port) and a BMC UART port via pin header X44. The UART signals on the lower port of connector X41 can be sourced from the module or the BMC. Use jumper X43 to select the desired UART source.

Table 17 COM Port - Connector X41 Pinout Description

COM0 (Lower)		COM1 (Upper)	
Pin	Signals	Pin	Signals
1	NC	11	NC
2	SER0_RXD / BMC_RXD	12	SER1_RXD
3	SER0_TXD / BMC_TXD	13	SER1_TXD
4	NC	14	NC
5	GND	15	GND
6	NC	16	NC
7	NC	17	NC
8	NC	18	NC
9	NC	19	NC

COM Ports - Connector X41

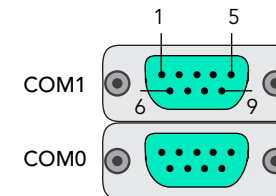

Table 18 Possible Serial Port Configuration

Configuration	Dual Stacked COM Port X41		Pin Header X44
	Upper Port	Lower Port	
1	COM Express UART 1	COM Express UART 0	BMC UART 1
2	COM Express UART 1	BMC Debug UART 5	BMC UART 1





Table 19 Pin Header X44 Pinout Description

Pin	Signal	Pin	Signal
1	BMC_DCD#	2	BMC_DSR
3	BMC_RXD	4	BMC_RTS#
5	BMC_TXD	6	BMC_CTS#
7	BMC_DTR#	8	BMC_RI#
9	GND	10	+5V (fuse)

BMC UART (X44)

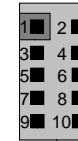
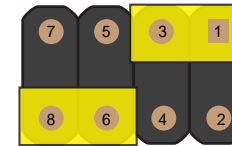

Table 20 Jumper X43 Pinout Description

Pin	Configuration
1-3, 6-8	Module UART to D-Sub connector (lower port, default)
2-4, 5-7	BMC Debug UART to D-Sub connector (lower port)
3-5, 4-6	Connect module UART and BMC UART

X41 UART Selection - Jumper X43



 Connector Type

X41: Dual 9-pin D-Sub connector

X44: 2 x 5-pin header

X43: 2 x 4-pin header



### 4.1.5.3 RJ45 Gigabit Ethernet Interface

The conga-X7/EVAL offers two RJ45 Gigabit Ethernet connectors—a standard network interface (from Type 7 module) on connector X19 and a BMC management interface on connector X32.

Use jumper X20 to set the power rail for the status LEDs D4 and D5.

Table 21 LAN X19 / X32 Pinout Description

Pin	Signal	Pin	Signal
1	MDI[0]+	2	MDI[0]-
3	MDI[1]+	4	MDI[1]-
5	MDI[2]+	6	MDI[2]-
7	MDI[3]+	8	MDI[3]-

LAN - X19 / X32

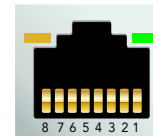

**Note**  
Industrial variants do not feature the BMC management interface (connector X32).

LEDs	Description
Yellow	Activity
Green	Link
D4	LINK1000#
D5	LINK100#

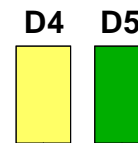
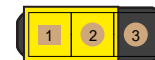

Table 22 Jumper X20 Pinout Description

Pin	Configuration
1-2	Status LEDs are standby powered
2-3	Status LEDs are only powered in S0

Jumper X20



#### Connector Type

X19, X32: 8 pin RJ45 plug

X20: 2.54 mm, 1 x 3-pin header



## 4.1.6 Fan Control

The conga-X7/EVAL provides a 4-pin header (connector X51) for connecting 5 V or 12 V cooling fans. The following tables describe the pinout and jumper configurations.

Use Jumper X50 to configure the fan's input voltage.

Table 23 Fan (Connector X51) Pinout Description

Pin	Signal
1	GND
2	+VDD (12V/5V)
3	Sense
4	PWM

Fan - X51

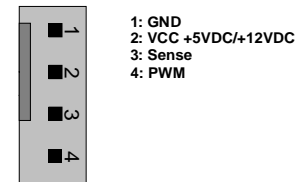
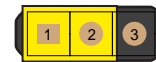

Table 24 Jumper X50 Pinout Description

Pin	Configuration
1-2	12 V supply voltage for auxiliary fan (default)
2-3	5 V supply voltage for auxiliary fan

Jumper X50



### Connector Type

X51: 2.54 mm, 4-pin header for 3-pin or 4-pin fan

X50: 2.54 mm, 1 x 3-pin header



## 4.1.7 Universal Serial Bus (USB)

The conga-X7/EVAL supports four USB 2.0/3.0 ports, the maximum count specified by the COM Express™ specification for Type 7 modules. The USB port 3 signals are shared between USB port 3 and Aspeed 2500 BMC. The shared signals are connected to the BMC by default.

Use jumper X18 to route the signals to USB 2.0 port 3 connector.

Table 25 Jumper X18 Pinout Description

Pin	Configuration
1-2	USB 2.0 port 3 to BMC
2-3	USB 2.0 port 3 to USB connector X16 (default)

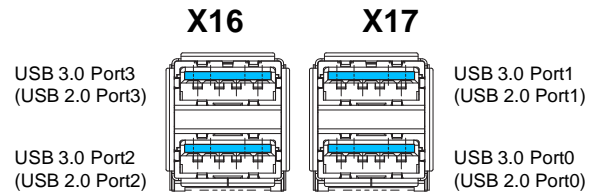

Jumper X18



### Connector Type

X16, X17: Dual USB 3.0 connector (Type A)

X18: 2.54 mm, 3-pin header

## 4.1.8 SATA™

### 4.1.8.1 SATA Interfaces

The conga-X7/EVAL provides two SATA interfaces—on connectors X12 and X13. The yellow LED D1 glows when an activity occurs on any of the SATA interfaces.

The pin header X15 provides an option to connect external HDD LED.

Table 26 Header X15 Pinout Description

Pin	Signal
1	Anode
2	Cathode



### Note

SATADOM modules are supported only on connector X12 (SATA0)

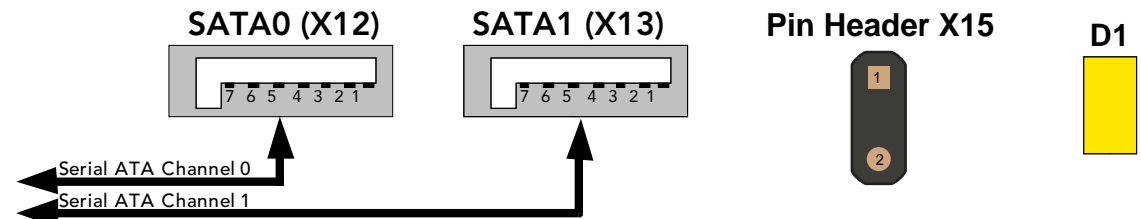



## Connector Type

X15: 2.54mm, 1x2 pin header

### 4.1.8.2 SATA Power

The conga-X7/EVAL provides SATA power for hard drives on connector X14. This connector supplies 3.3 V, 5 V and 12 V.

Table 27 Connector X14 Pinout Description

Pin	Signal	Pin	Signal	Pin	Signal
1	3.3 V	6	GND	11	GND
2	3.3 V	7	5 V	12	GND
3	3.3 V	8	5 V	13	12 V
4	GND	9	5 V	14	12 V
5	GND	10	GND	15	12 V

### SATA Power (X14)

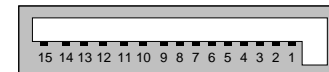

## Connector Type

X14: 15-pin standard SATA power connector

### 4.1.8.3 SATA-DOM Power

The conga-X7/EVAL provides power supply for SATA-DOM modules via jumper X65.

Jumper X65 Pinout Description

Pin	Configuration
1-2	GND (default)
2-3	5 V for SATA-DOM modules

### Jumper X65

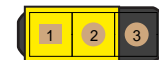

## Note

SATADOM modules are supported only on connector X12 (SATA0)

## Connector Type

X65: 2.54 mm, 1 x 3-pin header



## 4.1.9 PCI Express® Connectors

The conga-X7/EVAL features four PCI Express slots as shown below.

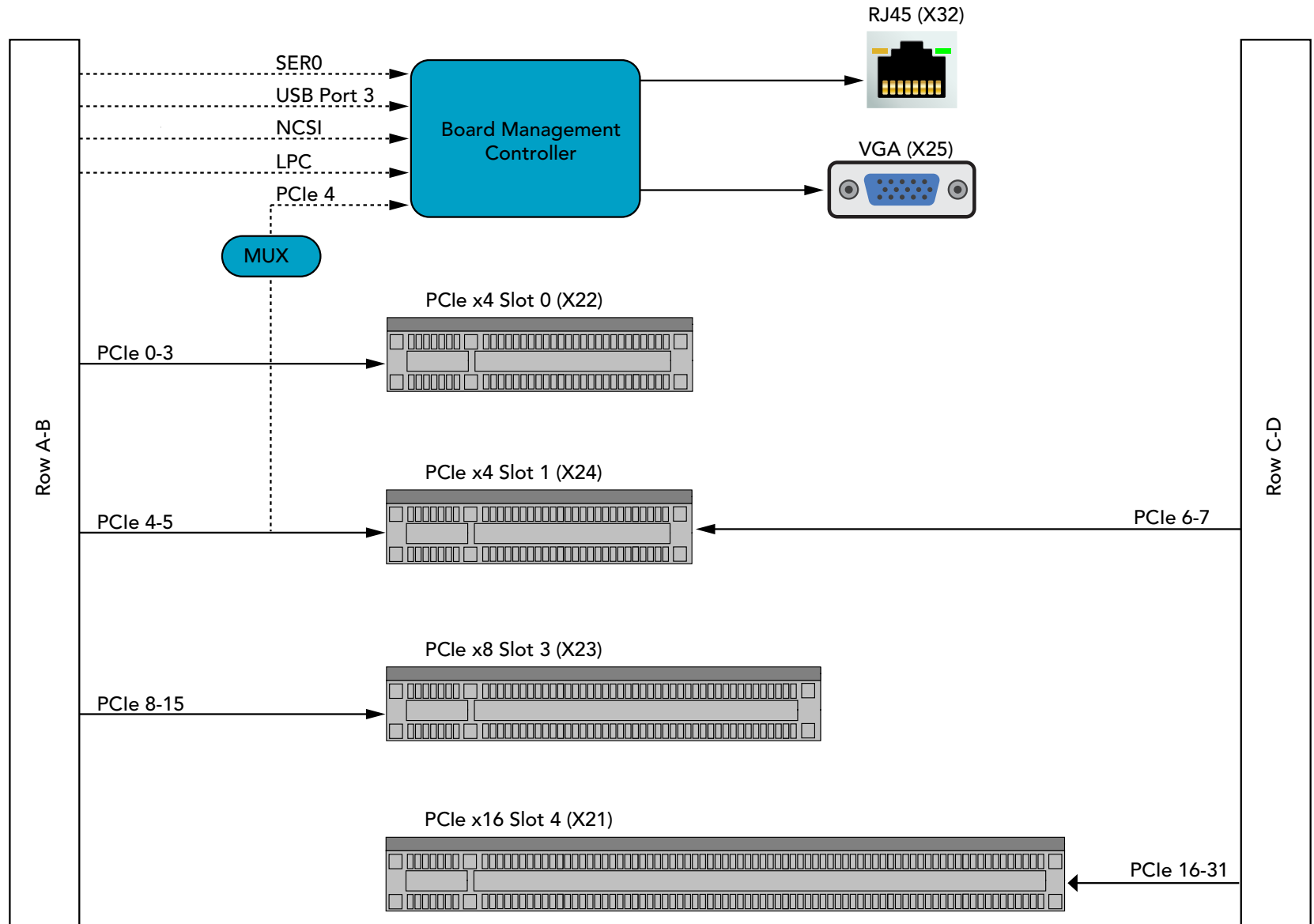



# 5 Subsystems of Connector Rows C - D

Table 28 Module Type 7 Connector Pinout—Rows C and D

Pin	Row C	Pin	Row D	Pin	Row C	Pin	Row D
C1	GND (FIXED)	D1	GND (FIXED)	C56	PCIE_RX17-	D56	PCIE_TX17-
C2	GND	D2	GND	C57	TYPE1#	D57	TYPE2#
C3	USB_SSRX0-	D3	USB_SSTX0-	C58	PCIE_RX18+	D58	PCIE_TX18+
C4	USB_SSRX0+	D4	USB_SSTX0+	C59	PCIE_RX18-	D59	PCIE_TX18-
C5	GND	D5	GND	C60	GND (FIXED)	D60	GND (FIXED)
C6	USB_SSRX1-	D6	USB_SSTX1-	C61	PCIE_RX19+	D61	PCIE_TX19+
C7	USB_SSRX1+	D7	USB_SSTX1+	C62	PCIE_RX19-	D62	PCIE_TX19-
C8	GND	D8	GND	C63	RSVD	D63	RSVD
C9	USB_SSRX2-	D9	USB_SSTX2-	C64	RSVD	D64	RSVD
C10	USB_SSRX2+	D10	USB_SSTX2+	C65	PCIE_RX20+	D65	PCIE_TX20+
C11	GND(FIXED)	D11	GND (FIXED)	C66	PCIE_RX20-	D66	PCIE_TX20-
C12	USB_SSRX3-	D12	USB_SSTX3-	C67	RAPID_SHUTDOWN	D67	GND
C13	USB_SSRX3+	D13	USB_SSTX3+	C68	PCIE_RX21+	D68	PCIE_TX21+
C14	GND	D14	GND	C69	PCIE_RX21-	D69	PCIE_TX21-
C15	10G_PHY_MDC_SCL3	D15	10G_PHY_MDIO_SDA3	C70	GND (FIXED)	D70	GND (FIXED)
C16	10G_PHY_MDC_SCL2	D16	10G_PHY_MDIO_SDA2	C71	PCIE_RX22+	D71	PCIE_TX22+
C17	10G_SDP2	D17	10G_SDP3	C72	PCIE_RX22-	D72	PCIE_TX22-
C18	GND	D18	GND	C73	GND	D73	GND
C19	PCIE_RX6+	D19	PCIE_TX6+	C74	PCIE_RX23+	D74	PCIE_TX23+
C20	PCIE_RX6-	D20	PCIE_TX6-	C75	PCIE_RX23-	D75	PCIE_TX23-
C21	GND (FIXED)	D21	GND (FIXED)	C76	GND	D76	GND
C22	PCIE_RX7+	D22	PCIE_TX7+	C77	RSVD	D77	RSVD
C23	PCIE_RX7-	D23	PCIE_TX7-	C78	PCIE_RX24+	D78	PCIE_TX24+
C24	10G_INT2	D24	10G_INT3	C79	PCIE_RX24-	D79	PCIE_TX24-
C25	GND	D25	GND	C80	GND (FIXED)	D80	GND (FIXED)
C26	10G_KR_RX3+	D26	10G_KR_TX3+	C81	PCIE_RX25+	D81	PCIE_TX25+
C27	10G_KR_RX3-	D27	10G_KR_TX3-	C82	PCIE_RX25-	D82	PCIE_TX25-
C28	GND	D28	GND	C83	RSVD	D83	RSVD
C29	10G_KR_RX2+	D29	10G_KR_TX2+	C84	GND	D84	GND



Pin	Row C	Pin	Row D	Pin	Row C	Pin	Row D
C30	10G_KR_RX2-	D30	10G_KR_TX2-	C85	PCIE_RX26+	D85	PCIE_TX26+
C31	GND (FIXED)	D31	GND (FIXED)	C86	PCIE_RX26-	D86	PCIE_TX26-
C32	10G_SFP_SDA3	D32	10G_SFP_SCL3	C87	GND	D87	GND
C33	10G_SFP_SDA2	D33	10G_SFP_SCL2	C88	PCIE_RX27+	D88	PCIE_TX27+
C34	10G_PHY_RST_23	D34	10G_PHY_CAP_23	C89	PCIE_RX27-	D89	PCIE_TX27-
C35	10G_PHY_RST_01	D35	10G_PHY_CAP_01	C90	GND (FIXED)	D90	GND (FIXED)
C36	10G_LED_SDA	D36	RSVD	C91	PCIE_RX28+	D91	PCIE_TX28+
C37	10G_LED_SCL	D37	RSVD	C92	PCIE_RX28-	D92	PCIE_TX28-
C38	10G_SFP_SDA1	D38	10G_SFP_SCL1	C93	GND	D93	GND
C39	10G_SFP_SDA0	D39	10G_SFP_SCL0	C94	PCIE_RX29+	D94	PCIE_TX29+
C40	10G_SDP0	D40	10G_SDP1	C95	PCIE_RX29-	D95	PCIE_TX29-
C41	GND (FIXED)	D41	GND (FIXED)	C96	GND	D96	GND
C42	10G_KR_RX1+	D42	10G_KR_TX1+	C97	RSVD	D97	RSVD
C43	10G_KR_RX1-	D43	10G_KR_TX1-	C98	PCIE_RX30+	D98	PCIE_TX30+
C44	GND	D44	GND	C99	PCIE_RX30-	D99	PCIE_TX30-
C45	10G_PHY_MDC_SCL1	D45	10G_PHY_MDIO_SDA1	C100	GND (FIXED)	D100	GND (FIXED)
C46	10G_PHY_MDC_SCL0	D46	10G_PHY_MDIO_SDA0	C101	PCIE_RX31+	D101	PCIE_TX31+
C47	10G_INT0	D47	10G_INT1	C102	PCIE_RX31-	D102	PCIE_TX31-
C48	GND	D48	GND	C103	GND	D103	GND
C49	10G_KR_RX0+	D49	10G_KR_TX0+	C104	VCC_12V	D104	VCC_12V
C50	10G_KR_RX0-	D50	10G_KR_TX0-	C105	VCC_12V	D105	VCC_12V
C51	GND (FIXED)	D51	GND(FIXED)	C106	VCC_12V	D106	VCC_12V
C52	PCIE_RX16+	D52	PCIE_TX16+	C107	VCC_12V	D107	VCC_12V
C53	PCIE_RX16-	D53	PCIE_TX16-	C108	VCC_12V	D108	VCC_12V
C54	TYPE0#	D54	RSVD	C109	VCC_12V	D109	VCC_12V
C55	PCIE_RX17+	D55	PCIE_TX17+	C110	GND (FIXED)	D110	GND (FIXED)





## 5.1 PCI Express® Connector

The conga-X7/EVAL provides a PCIe x16 port on connector X21. For more information about the pinout, refer to the PCI Express Card Electromechanical Specification.

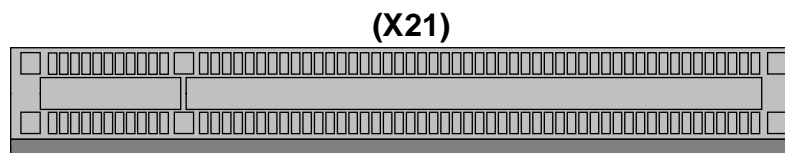

### Connector Type

X21: Standard x16 PCIe slot

## 5.2 10 Gigabit Ethernet (GbE)

The conga-X7/EVAL offers four 10 GbE KR ports on connectors X34, X36, X38 and X40, enclosed in two EMI-shielded SFP+ cages (X35 and X39).

**10 GbE Port**  
**(X34 / X36 / X38 / X40)**

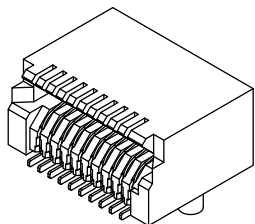

**SFP+ 1x2 Cage (X35 / X39)**

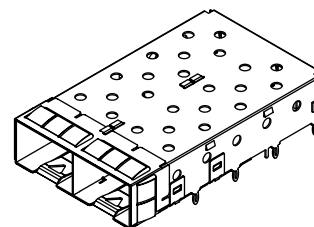

### Connector Type

X34, X36, X38, X40: 20-Pin SFP+ Connector

X35, X39: SFP+ 1 x 2 cage with EMI Shield



## 5.3 Configurable I/O Pins

The conga-X7/EVAL provides four interfaces for software definable pins (SDP) via SMA connectors X7, X8, X10 and X11. These connectors support input or output operations and can be used for IEEE 1588 device connection or other functions depending on the SDP features the COM Express module support.

**X7 / X8 / X10 / X11**

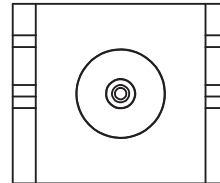

### Connector Type

X7, X8, X10, X11: SMA RF Connector

## 5.4 Management Interface for PHY and MAC

The conga-X7/EVAL offers pin header X5 for managing the communication between the PHY on the carrier board and the MAC on the COM Express module.

Table 29 Pin Header X5 Pinout Description

Pin	Signal
1	LAN1_MDC_SCL
2	LAN1_MDIO_SDA
3	LAN3_MDC_SCL
4	LAN3_MDIO_SDA

**X5**



### Connector Type

X5: 2.54 mm, 1 x 5-pin header



## 6 Additional Features

### 6.1 Buttons

The conga-X7/EVAL features four different buttons—power, reset, LID and sleep buttons.

#### 6.1.1 Power

When using an ATX power supply, the COM Express™ module starts after the power-on button M19 is pressed.

**Pwr On (M19)**



#### 6.1.2 Reset

The COM Express™ module and all connected components will perform a hard reset when this button is pressed. The Reset button is connected to the COM Express™ module's SYS\_RESET# signal.

**Reset (M20)**



#### 6.1.3 LID

Press LID button M21 to trigger the LID# signal. The system's behaviour depends on the ACPI settings of the Operating System.

**LID (M21)**



#### 6.1.4 Sleep

Press SLEEP button M22 to trigger the SLEEP# signals. The system's behavior depends on the ACPI settings of the Operating System.

**Sleep (M22)**





## 6.2 PC Speaker

The board-mounted speaker provides audible error code (beep code) information during POST. The speaker M18 is connected to the COM Express™ module's SPEAKER signal and can be configured via Jumper X60.

Table 30 Jumper X60 Pinout Description

Pin	Configuration
1 - 2	Normal operation (default)
2 - 3	XDP bootstrap

Jumper X60

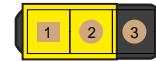

Speaker - M18

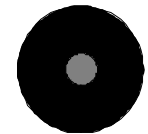

### Connector Type

X60: 2.54 mm grid jumper

## 6.3 Debug Display

During the POST (Power On Self Test), the BIOS generates diagnostic progress codes (POST-codes) to different I/O ports (usually port 80h). If the POST fails, execution stops and the last POST code generated is left at the respective port. This code is useful for determining the point where an error occurred. The conga-X7/EVAL decodes these ports and displays their contents on a 4 seven-segment display (D27 - D30).

A list of the POST codes and associated POST test and initialization routines for the BIOS used on congatec COM Express™ modules is available at [www.congatec.com](http://www.congatec.com).

Table 31 Jumper X59 Pinout Description

Pin	Configuration
1 - 2	Enable POST code (default)
2 - 3	Disable POST code

Jumper X59

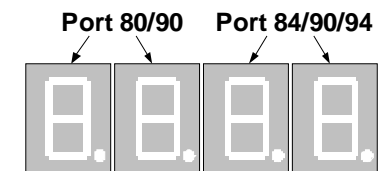
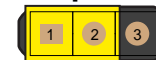

### Connector Type

X59: 2.54 mm grid jumper



## 6.4 Ground Test Points

The conga-X7/EVAL provides 4 test points that are connected to Ground Potential (M1 to M4). These test points make it easier to connect oscilloscope probes and/or multimeter lines to ground when performing measurements on the COM Express™ module.

### Test Points (M1-M4)

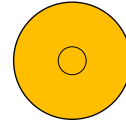

## 6.5 Feature Connector

Table 32 Feature Connector X49 Pinout Description

Pin	Signal	Description	Pin	Signal	Description
1	+5V (750 mA fuse)		2	5V_SB (750 mA fuse)	
3	330R PU to +5V (for LED anode)		4	Hard Disk Activity	Shows activity on hard disk interface
5	I2DAT	General purpose I <sup>2</sup> C port data I/O line.	6	SMBCLK_SB	System Management Bus bidirectional clock line.
7	I2CLK	General purpose I <sup>2</sup> C port clock output.	8	SMBDATA_SB	System Management Bus bidirectional data line.
9	Internal use		10	GPO0	
11	Internal use		12	GPO1	
13	PS_ON#	Power Supply On (active low).	14	GPO2	
15	SUS_S3#	Indicates system is in Suspend to RAM state. Active low output.	16	GPO3	
17	GND	Power Ground	18	GND	Power Ground
19	THRMTRIP#	Active low output indicating that the CPU has entered thermal shutdown.	20	SMBALERT#	System Management Bus Alert – active low input can be used to generate an SMI# (System Management Interrupt) or to wake the system.
21	GPI1		22	SUS_S4#	Indicates systems is in Suspend to Disk state. Active low output.
23	SUS_STAT#	Indicates imminent suspend operation; used to notify LPC devices.	24	GPI0	
25	GPI2		26	SUS_S5#	Indicates systems is in Soft Off state.
27	WDTRIG		28	THRM#	Input from off-module temp sensor indicating an over-temp situation.

### Feature (X49)

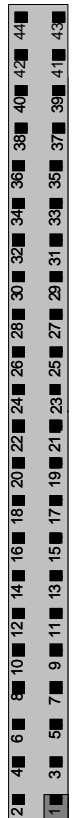



29	GPI3		30	LID#	Module input signal, generation a LID close or open event
31	BATLOW#	Indicates that external battery is low.	32	WAKE1#	General purpose wake up signal. May be used to implement wake-up on PS2 keyboard or mouse activity.
33	TPM_PP	Physical presence pin, indication signal to TPM chip	34	PEG_LANE_RV#	PCI Express Graphics lane reversal input strap.
35	SLEEP#	Sleep signal, to bring system to a predefined sleep state	36	SYS_RESET#	Reset Button Input. Active low input. System is held in hardware reset while this input is low and comes out of reset upon release.
37	GND	Power Ground	38	GND	Power Ground
39	PWBTN#	Power Button to bring system out of S5 (soft off), active on rising edge.	40	PWR_OK	Power OK from main power supply. A high value indicates that the power is good. For additional information refer to PWRGOOD Config connector X11.
41	SER0_TX	Serial Port 0 Transmit Line of COM Express Module	42	SER1_TX	Serial Port 1 Transmit Line of COM Express Module
43	SER0_RX	Serial Port 0 Receive Line of COM Express Module	44	SER1_RX	Serial Port 1 Receive Line of COM Express Module

### Connector Type

X49: 2.54 mm, 2 x 22-pin grid female

## 6.6 CPLD Programming Header - Internal Use Only

Connector X9 is used for programming the CPLD. This connector is designated for internal use only.

Pin	Signal	Pin	Signal
1	CPLD_JTAG_TCK	2	GND
3	CPLD_JTAG_TDO	4	VCC3V3_PROG
5	CPLD_JTAG_TMS	6	N.C.
7	N.C.	8	N.C.
9	CPLD_JTAG_TDI	10	GND

### Pin Header X9



### Connector Type

X9: 2.54 mm, 2 x 5-pin header



## 6.7 cBC Programming Header - Internal Use Only

Connector X6 is used for programming the congatec Board Controller. This connector is designated for internal use only.

Pin	Signal	Pin	Signal
1	VCC3V3_PROG	2	CGBC_TMS
3	GND	4	CGBC_TCK
5	GND	6	CGBC_TDO
7	N.C.	8	CGBC_TDI
9	GND	10	N.C.

### Connector Type

X6: 2.54 mm, 2 x 5-pin header

### Pin Header X6



## 6.8 BMC Configuration Jumpers

Jumpers X27, X31, X61, X62, X63 are designated for internal use only.

### Connector Type

X27,X31,X61-X63: 2.54 mm grid jumper

### Jumpers X27/X31/X61-X63

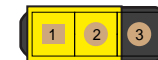



# 7 Mechanical Dimensions

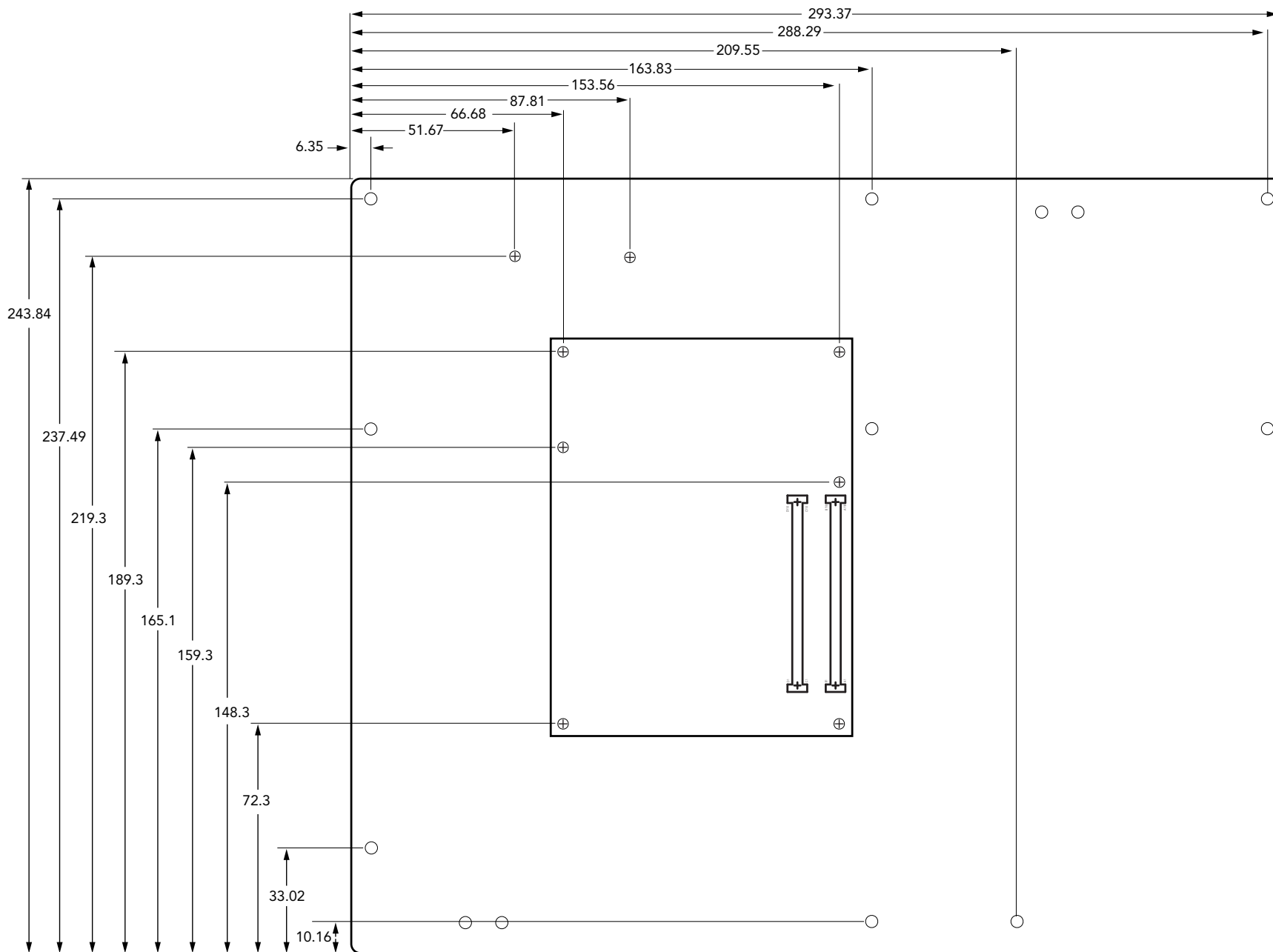





## 8 Industry Specifications

The list below provides links to industry specifications that should be used as reference material when designing a COM Express™ carrier board.

Specification	Link
PICMG® COM Express Module™ Base Specification	<a href="http://www.picmg.org/">http://www.picmg.org/</a>
PCI Express Base Specification	<a href="http://www.pcisig.com/specifications">http://www.pcisig.com/specifications</a>
Universal Serial Bus (USB) Specification	<a href="http://www.usb.org/home">http://www.usb.org/home</a>
Serial ATA Specification	<a href="http://www.serialata.org">http://www.serialata.org</a>
IEEE standard 802.3ab 1000BASE T Ethernet	<a href="http://www.ieee.org/portal/site">http://www.ieee.org/portal/site</a>
Advanced Configuration and Power Interface Specification	<a href="http://www.acpi.info/">http://www.acpi.info/</a>