

User's Manual

Display Computing Solution



Industrial Panel PC

Power Efficient Sunlight Readable Series

CS-100/P1100 Series

Contents

Preface

Revision	04
Copyright Notice	04
Acknowledgement	04
Disclaimer	04
Declaration of Conformity	04
Product Warranty Statement	05
Technical Support and Assistance	06
Conventions Used in this Manual	06
Safety Precaution	07
Package Contents	08
Ordering Information	08
Optional Accessories and Modules.....	10

Chapter 1 Product Introductions

1.1 Overview	12
1.2 Highlights	12
1.3 Product Pictures	13
1.4 Key Feature	13
1.5 Hardware Specification	14
1.5.1 CS-110HC/P1101-E50 (N42) & CS-110HC-OB/P1101-E50 (N42)	14
1.5.2 CS-112HC/P1101-E50 (N42) & CS-112HC-OB/P1101-E50 (N42)	16
1.5.3 CS-115C/P1101-E50 (N42) & CS-115C-OB/P1101-E50 (N42)	18
1.5.4 CS-117C/P1101-E50 (N42) & CS-117C-OB/P1101-E50 (N42)	20
1.5.5 CS-119C/P1101-E50 (N42) & CS-119C-OB/P1101-E50 (N42)	22
1.6 System I/O	24
1.6.1 Front	24
1.6.2 Rear	24
1.6.3 Side (Left)	25
1.6.4 Side (Right)	25
1.6.5 Top	26

Chapter 2 System Pin Definitions and Settings

2.1 Settings	28
2.2 Location of the Connectors, Jumpers and Switches	28
2.2.1 Top View	28
2.2.2 Bottom View	29
2.3 Connector / Jumper / Switch Definition	30
2.4 Definition of Switches	31
2.5 Definition of Connectors	33

Chapter 3 System Setup

3.1 Removing the Top Cover	38
3.2 Installing a Half Size Mini PCIe Card	39
3.3 Installing a Full Size Mini PCIe Card	40
3.4 Installing Antennas	41
3.5 Installing a SO-DIMM	43

3.6	Installing CPU Thermal Pad	44
3.7	Installing the Top Cover	44
3.8	Installing a SATA Hard Drive	45
3.9	Installing a SIM Card	47
3.10	Connecting with CS Display Module	48
3.11	VESA Mount	50
3.12	Panel Mount.....	51
Chapter 4 BIOS Setup		
4.1	BIOS Introduction	56
4.2	Main Setup	57
4.3	Advanced Setup	58
4.3.1	ACPI Settings	58
4.3.2	F81866 Super IO Configuration	59
4.3.3	Hardware Monitor	61
4.3.4	S5 RTC Wake Setting	61
4.3.5	Serial Port Console Redirection	62
4.3.6	CPU Configuration	63
4.3.7	Network Stack Configuration	64
4.3.8	CSM Configuration	64
4.3.9	USB Configuration	66
4.4	Chipset Setup.....	67
4.4.1	North Bridge	67
4.4.2	South Bridge	68
4.4.3	South Cluster Configuration	69
4.5	Security Setup	72
4.6	Boot Setup	73
4.7	Save & Exit	74
Chapter 5 Product Application		
5.1	Digital I/O (DIO) application.....	76
5.1.1	Digital I/O Programming Guide	76
5.2	Digital I/O (DIO) Hardware Specification	81
Chapter 6 Optional Module Pin Definitions and Settings		
6.1	Location of the Connectors and Switches	84
6.2	Installing a CFM-IGN Power Ignition Module	84
6.3	Installing a CFM-PoE Control Module	86

Preface

Revision

Revision	Description	Date
1.0	First Release	2018/07/30

Copyright Notice

© 2017 by Cincoze Co., Ltd. All rights are reserved. No parts of this manual may be copied, modified, or reproduced in any form or by any means for commercial use without the prior written permission of Cincoze Co., Ltd. All information and specification provided in this manual are for reference only and remain subject to change without prior notice.

Acknowledgement

Cincoze is a registered trademark of Cincoze Co., Ltd. All registered trademarks and product names mentioned herein are used for identification purposes only and may be trademarks and/or registered trademarks of their respective owners.

Disclaimer

This manual is intended to be used as a practical and informative guide only and is subject to change without notice. It does not represent a commitment on the part of Cincoze. This product might include unintentional technical or typographical errors. Changes are periodically made to the information herein to correct such errors, and these changes are incorporated into new editions of the publication.

Declaration of Conformity



FCC

This equipment has been tested and found to comply with the limits for a Class A digital device, pursuant to Part 15 of the FCC Rules. These limits are designed to provide reasonable protection against harmful interference when the equipment is operated in a commercial environment. This equipment generates, uses, and can radiate radio frequency energy and, if not installed and used in accordance with the instruction manual, may cause harmful interference to radio communications. Operation of this equipment in a residential area is likely to cause harmful interference in which case the user will be required to correct the interference at his own expense.



CE

The product(s) described in this manual complies with all application European Union (CE) directives if it has a CE marking. For computer systems to remain CE compliant, only CE-compliant parts may be used. Maintaining CE compliance also requires proper cable and cabling techniques.

Product Warranty Statement

Warranty

Cincoze products are warranted by Cincoze Co., Ltd. to be free from defect in materials and workmanship for 2 years from the date of purchase by the original purchaser.

During the warranty period, we shall, at our option, either repair or replace any product that proves to be defective under normal operation.

Defects, malfunctions, or failures of the warranted product caused by damage resulting from natural disasters (such as by lightening, flood, earthquake, etc.), environmental and atmospheric disturbances, other external forces such as power line disturbances, plugging the board in under power, or incorrect cabling, and damage caused by misuse, abuse, and unauthorized alteration or repair, and the product in question is either software, or an expendable item (such as a fuse, battery, etc.), are not warranted.

RMA

Before sending your product in, you will need to fill in Cincoze RMA Request Form and obtain a RMA number from us. Our staff is available at any time to provide you with the most friendly and immediate service.

■ RMA Instruction

- Customers must fill in Cincoze Return Merchandise Authorization (RMA) Request Form and obtain a RMA number prior to returning a defective product to Cincoze for service.
- Customers must collect all the information about the problems encountered and note anything abnormal and describe the problems on the "Cincoze Service Form" for the RMA number apply process.
- Charges may be incurred for certain repairs. Cincoze will charge for repairs to products whose warranty period has expired. Cincoze will also charge for repairs to products if the damage resulted from acts of God, environmental or atmospheric disturbances, or other external forces through misuse, abuse, or unauthorized alteration or repair. If charges will be incurred for a repair, Cincoze lists all charges, and will wait for customer's approval before performing the repair.
- Customers agree to insure the product or assume the risk of loss or damage during transit, to prepay shipping charges, and to use the original shipping container or equivalent.
- Customers can be send back the faulty products with or without accessories (manuals, cable, etc.) and any components from the system. If the components were suspected as part of the problems, please note clearly which components are included. Otherwise, Cincoze is not responsible for the devices/parts.
- Repaired items will be shipped along with a "Repair Report" detailing the findings and actions taken.

Limitation of Liability

Cincoze' liability arising out of the manufacture, sale, or supplying of the product and its use, whether based on warranty, contract, negligence, product liability, or otherwise, shall not exceed the original selling price of the product. The remedies provided herein are the customer's sole and exclusive remedies. In no event shall Cincoze be liable for direct, indirect, special or consequential damages whether based on contract of any other legal theory.

Technical Support and Assistance

1. Visit the Cincoze website at www.cincoze.com where you can find the latest information about the product.
2. Contact your distributor or our technical support team or sales representative for technical support if you need additional assistance. Please have following information ready before you call:
 - Product name and serial number
 - Description of your peripheral attachments
 - Description of your software (operating system, version, application software, etc.)
 - A complete description of the problem
 - The exact wording of any error messages

Conventions Used in this Manual



WARNING

This indication alerts operators to an operation that, if not strictly observed, may result in severe injury.



CAUTION

This indication alerts operators to an operation that, if not strictly observed, may result in safety hazards to personnel or damage to equipment.



NOTE

This indication provides additional information to complete a task easily.

Safety Precautions

Before installing and using this device, please note the following precautions:

1. Read these safety instructions carefully.
2. Keep this User's Manual for future reference.
3. Disconnect this equipment from any AC outlet before cleaning.
4. For plug-in equipment, the power outlet socket must be located near the equipment and must be easily accessible.
5. Keep this equipment away from humidity.
6. Put this equipment on a reliable surface during installation. Dropping it or letting it fall may cause damage.
7. Make sure the voltage of the power source is correct before connecting the equipment to the power outlet.
8. Use a power cord that has been approved for using with the product and that it matches the voltage and current marked on the product's electrical range label. The voltage and current rating of the cord must be greater than the voltage and current rating marked on the product.
9. Position the power cord so that people cannot step on it. Do not place anything over the power cord.
10. All cautions and warnings on the equipment should be noted.
11. If the equipment is not used for a long time, disconnect it from the power source to avoid damage by transient overvoltage.
12. Never pour any liquid into an opening. This may cause fire or electrical shock.
13. Never open the equipment. For safety reasons, the equipment should be opened only by qualified service personnel.

If one of the following situations arises, get the equipment checked by service personnel:

- The power cord or plug is damaged.
 - Liquid has penetrated into the equipment.
 - The equipment has been exposed to moisture.
 - The equipment does not work well, or you cannot get it work according to the user's manual.
 - The equipment has been dropped and damaged.
 - The equipment has obvious signs of breakage.
14. **CAUTION:** Danger of explosion if battery is incorrectly replaced. Replace only with the same or equivalent type recommended by the manufacturer.

Package Contents

Before installation, please ensure all the items listed in the following table are included in the package.

Item	Description	Q'ty
1	Panel PC	1
2	Utility DVD Driver	1
3	Screw Pack	1
4	Panel Mounting Kit	1
5	Power Terminal Block Connector	1
6	Remote Power On/Off Terminal Block Connector	1
7	DIO Terminal Block Connector	1
8	Thermal Pad (for CPU Thermal Block)	1

Note: Notify your sales representative if any of the above items are missing or damaged.

Ordering Information

Model No.	Product Description
CS-110HC-R10/P1101-E50-R10	10.4" TFT-LCD 1500nits Sunlight Readable Touch Panel PC with Intel® Atom® E3950 Quad Core Processor and P-Cap. Touch
CS-110HC-OB-R10/P1101-E50-R10	10.4" TFT-LCD 1500nits Sunlight Readable Touch Panel PC with Intel® Atom® E3950 Quad Core Processor, P-Cap. Touch and Optical Bonding
CS-110HC-R10/P1101-N42-R10	10.4" TFT-LCD 1500nits Sunlight Readable Touch Panel PC with Intel® Pentium® N4200 Quad Core Processor and P-Cap. Touch
CS-110HC-OB-R10/P1101-N42-R10	10.4" TFT-LCD 1500nits Sunlight Readable Touch Panel PC with Intel® Pentium® N4200 Quad Core Processor, P-Cap. Touch and Optical Bonding
CS-112HC-R10/P1101-E50-R10	12.1" TFT-LCD 1500nits Sunlight Readable Touch Panel PC with Intel® Atom® E3950 Quad Core Processor and P-Cap. Touch
CS-112HC-OB-R10/P1101-E50-R10	12.1" TFT-LCD 1500nits Sunlight Readable Touch Panel PC with Intel® Atom® E3950 Quad Core Processor, P-Cap. Touch and Optical Bonding

Model No.	Product Description
CS-112HC-R10/P1101-N42-R10	12.1" TFT-LCD 1500nits Sunlight Readable Touch Panel PC with Intel® Pentium® N4200 Quad Core Processor and P-Cap. Touch
CS-112HC-OB-R10/P1101-N42-R10	12.1" TFT-LCD 1500nits Sunlight Readable Touch Panel PC with Intel® Pentium® N4200 Quad Core Processor, P-Cap. Touch and Optical Bonding
CS-115C-R10/P1101-E50-R10	15" TFT-LCD 1600nits Sunlight Readable Touch Panel PC with Intel® Atom® E3950 Quad Core Processor and P-Cap. Touch
CS-115C-OB-R10/P1101-E50-R10	15" TFT-LCD 1600nits Sunlight Readable Touch Panel PC with Intel® Atom® E3950 Quad Core Processor, P-Cap. Touch and Optical Bonding
CS-115C-R10/P1101-N42-R10	15" TFT-LCD 1600nits Sunlight Readable Touch Panel PC with Intel® Pentium® N4200 Quad Core Processor and P-Cap. Touch
CS-115C-OB-R10/P1101-N42-R10	15" TFT-LCD 1600nits Sunlight Readable Touch Panel PC with Intel® Pentium® N4200 Quad Core Processor, P-Cap. Touch and Optical Bonding
CS-117C-R10/P1101-E50-R10	17" TFT-LCD 1500nits Sunlight Readable Touch Panel PC with Intel® Atom® E3950 Quad Core Processor and P-Cap. Touch
CS-117C-OB-R10/P1101-E50-R10	17" TFT-LCD 1500nits Sunlight Readable Touch Panel PC with Intel® Atom® E3950 Quad Core Processor, P-Cap. Touch and Optical Bonding
CS-117C-R10/P1101-N42-R10	17" TFT-LCD 1500nits Sunlight Readable Touch Panel PC with Intel® Pentium® N4200 Quad Core Processor and P-Cap. Touch
CS-117C-OB-R10/P1101-N42-R10	17" TFT-LCD 1500nits Sunlight Readable Touch Panel PC with Intel® Pentium® N4200 Quad Core Processor, P-Cap. Touch and Optical Bonding
CS-119C-R10/P1101-E50-R10	19" TFT-LCD 1600nits Sunlight Readable Touch Panel PC with Intel® Atom® E3950 Quad Core Processor and P-Cap. Touch
CS-119C-OB-R10/P1101-E50-R10	19" TFT-LCD 1600nits Sunlight Readable Touch Panel PC with Intel® Atom® E3950 Quad Core Processor, P-Cap. Touch and Optical Bonding
CS-119C-R10/P1101-N42-R10	19" TFT-LCD 1600nits Sunlight Readable Touch Panel PC with Intel® Pentium® N4200 Quad Core Processor and P-Cap. Touch
CS-119C-OB-R10/P1101-N42-R10	19" TFT-LCD 1600nits Sunlight Readable Touch Panel PC with Intel® Pentium® N4200 Quad Core Processor, P-Cap. Touch and Optical Bonding

Optional Modules & Accessories

Model No.	Description
CFM-IGN101	CFM Module with Power Ignition Sensing Control Function, 12V/24V Selectable (43 x 36 mm)
CFM-PoE02	CFM Module with PoE Control Function, Individual Port 25.5W
GST60A12-CIN	Adapter AC/DC 12V 5A 60W, GST60A12-CIN, wide temp (-30°C ~ +70°C), level VI
GST120A24-CIN	Adapter AC/DC 24V 5A 120W, GST120A24-CIN, wide temp (-30°C ~ +70°C), level VI
GST220A24-CIN	Adapter AC/DC 24V 9.2A 220W, GST220A24-CIN, wide temp (-30°C ~ +70°C), level VI (For CS-119C/P1101 only)
SL2-SL3	US 2 heads power cord, US B type to IEC C13, SVT 18AWG/3C Black 1.8M SL-2+SL-3
SL6-SL3	EU 2 heads power cord, EU G type to IEC C13, H05VV-F 0.75mm ² /3G Black 1.8M SL-6+SL-3
QP026-SL3	UK 2 heads power cord, UK I type to IEC C13, H05VV-F 0.75mm ² /3G Black 1.8M QP026+SL-3
Uni-Rack Mount kit	Universal Rack Mount Kit



Chapter 1

Product Introductions

1.1 Overview

CS-100/P1100 Series is a TFT-LCD sunlight readable touch panel PC offering ultra-high brightness and high resolution. The system is based on Intel® Atom® / Pentium® processor and supports triple independent displays (via VGA and DisplayPort outputs). CS-100/P1100 Series features extensive connectivity including 2x GbE, 4x USB 3.0, 4x COM, and 8x isolated DIO. It also offers 2x full size Mini-PCIe socket and 1x SIM socket for a variety of wireless data connections.

Through the ready-to-use CFM modules, users can easily add power ignition sensing and Power over Ethernet (PoE) functions for a variety of applications. CS-100/P1100 Series also supports Convertible Display System (CDS) technology. Comparing with regular standalone panel PCs, it is more flexible and reduces maintenance cost dramatically.

Featuring with rigorous industrial protections, wide range operating temperature (-20°C to 70°C), IP65 dust/waterproof front panel, and wide range DC power input (9 to 48VDC), CS-100/P1100 Series is appropriate for harsh environments and critical applications.

1.2 Highlights



Sunlight Readable

Providing ultra high brightness and high resolution, CS-100/P1100 Series is suitable for all lighting conditions including direct sunlight.



Wide Temperature

CS-100/P1100 Series supports wide range operating temperature from -20°C to 70°C and is suitable for deploying in extreme and harsh environments.



Multiple Functions

CS-100/P1100 Series provides extensive I/O, Mini-PCIe slot, 2.5" SATA drive bay, mSATA socket, and SIM card slot. It also supports power ignition sensing and PoE by adding ready-to-use CFM modules.

1.3 Product Pictures

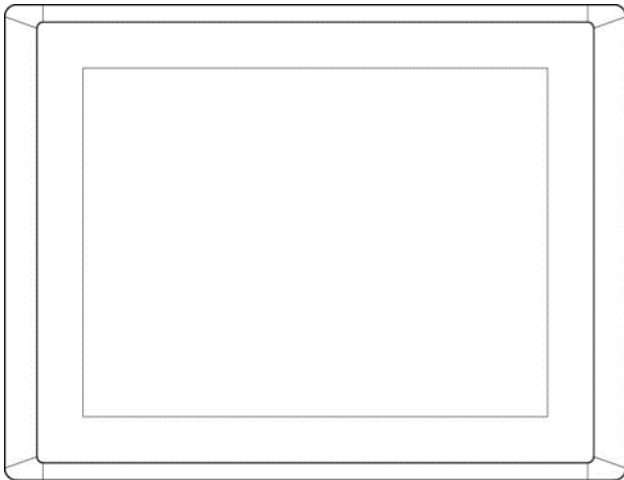

Front

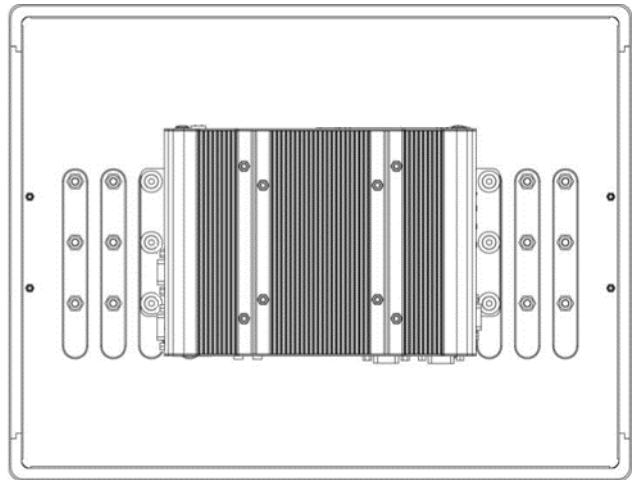

Rear

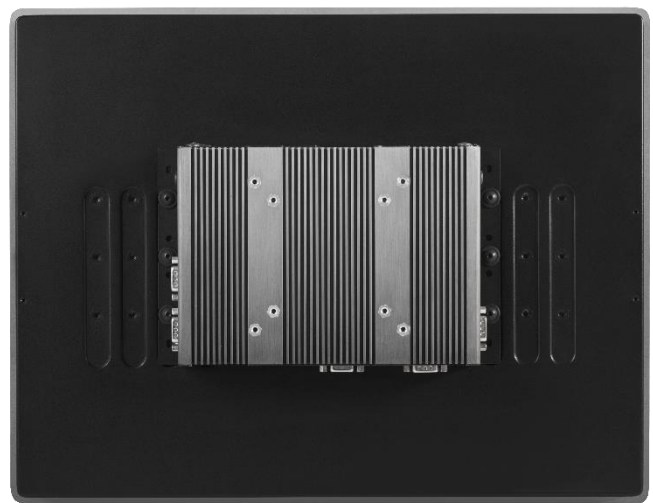

1.4 Key Features

- 10.1" ~ 19" TFT LCD with Ultra High Brightness up to 1,600nits
- Onboard Intel® Atom® / Pentium® Processor
- Triple Independent Displays (via VGA and DisplayPort outputs)
- Rich I/O (2x GbE LAN, 4x USB 3.0, 4x COM, 8x Isolated DIO)
- 2x Full Size Mini-PCIe, 1x 2.5" SATA Drive Bay, 1x mSATA Socket
- Wide Range Operating Temperature -20°C to 70°C
- Designed with Aluminum Die-casting Front Frame
- True Flat IP65 Front Panel Protection
- Supports CDS Technology, Ignition Sensing and Power over Ethernet
- Supports Panel / VESA / Rack Mounting
- Supports Optical Bonding

1.5 Hardware Specification

1.5.1 CS-110HC/P1101-E50 (N42) & CS-110HC-OB/P1101-E50 (N42)

Display

- LCD Size: 10.4" (4:3)
- Max. Resolution: 1024 x 768
- Brightness (cd/m²): 1500
- Contrast Ratio: 1400 : 1
- LCD Color: 16.2M
- Pixel Pitch (mm): 0.206 (H) x 0.206 (V)
- Viewing Angle (H-V): 178 / 178
- Backlight MTBF: 50000 hrs. (LED Backlight)

Touch

- Projected Capacitive Touch

Processor System

- Onboard Intel® Atom® x7-E3950 Quad Core Processor, up to 2.00 GHz
- Onboard Intel® Pentium® N4200 Quad Core Processor, up to 2.50 GHz

Memory

- 1x DDR3L 1333/1600/1866 MHz 204-Pin SO-DIMM Socket
- Supports up to 8GB (un-buffered and non-ECC)

Graphics

- Integrated Intel® HD Graphics 505
- Supports Triple Independent Display (via VGA & DisplayPort outputs)

Audio Codec

- Realtek ALC888-GR

External I/O Interface

- 1x VGA (1920 x 1200 @60Hz)
- 1x DisplayPort (4K x 2K @60Hz)
- 2x GbE LAN (Supports WoL, Teaming, Jumbo Frame & PXE), RJ45
 - GbE1: Intel® I210AT
 - GbE2: Intel® I210AT
- 4x USB 3.0 (Type A)
- 4x RS-232/422/485 with Auto Flow Control (Supports 5V/12V), DB9
- 1x Speaker-out & 1x Mic-in, Phone Jack 3.5mm
- 1x ATX Power On/Off Button
- 1x Reset Button
- 1x AT/ATX Mode Switch
- 1x Clear CMOS Switch
- 1x Remote Power On/Off Connector, 2-pin Terminal Block
- 8x Isolated DIO (4x DI/4x DO), 10-Pin Terminal Block

Storage

- 1x 2.5" HDD/SSD Drive Bay (SATA 3.0)
- 1x mSATA Socket (SATA 3.0, Shared by Mini-PCIe Socket)

Expansion

- 2x Full-size Mini-PCIe Socket
- 1x SIM Socket
- Supports Control Function Module (CFM) Technology
 - Optional CFM IGN Module for Power Ignition Function
 - Optional CFM PoE Module for Power over Ethernet Function
- Supports Convertible Display System (CDS) Technology
- 4x Antenna Holes

Other Features

- Watchdog Timer: Software Programmable Supports 1~255 sec.
- Internal Speaker AMP 2W + 2W
- OSD Function: LCD On/Off, Brightness Up, Brightness Down
- SuperCap Integrated for CMOS Battery-free Operation
- Supports Instant Reboot Technology (0.2 sec)

Power Requirement

- Supports AT/ATX Power Type
- 1x 3-pin Terminal Block
- Power Input Voltage 9~48VDC
- Power Adapter AC/DC 12V/5A 60W or 24V/5A 120W (Optional)

Physical

- Dimension (WxDxH, mm): 295 X 227.3 X 69.35 mm
- Weight: 3.73 kg
- Construction: Extruded Aluminum with Heavy Duty Metal
- Front Panel Construction: Flat Rugged Aluminum Die-casting Bezel
- Mounting: Panel / VESA / *Rack Mounting (*with optional mounting kit)
- Fanless Design

Environment

- Operating Temperature: -20°C to 70°C (with extended temperature peripherals; Ambient with air flow)
- Storage Temperature: -20°C to 70°C
- Relative Humidity: 90% RH @ 40°C (non-condensing)
- Shock: Operating, 15 Grms, Half-sine 11 ms Duration (w/ SSD, according to IEC60068-2-27)
- Vibration: Operating, 1.5 Grms, 5-500 Hz, 3 Axes (w/ SSD, according to IEC60068-2-64)
- IP Level: IP 65 Compliant Front Panel
- EMC: CE, FCC Class A

Protection

- Reverse Power Input Protection
- Over Voltage Protection: 58V
- Over Current Protection: 15A
- ESD Protection: +/-15kV (air), +/-8kV (contact)
- Surge Protection: 3.84 kV (impedance 12 ohm 1.2/50µs waveform)

Operating System

- Windows® 10
- Linux: Supports by project

Dimension

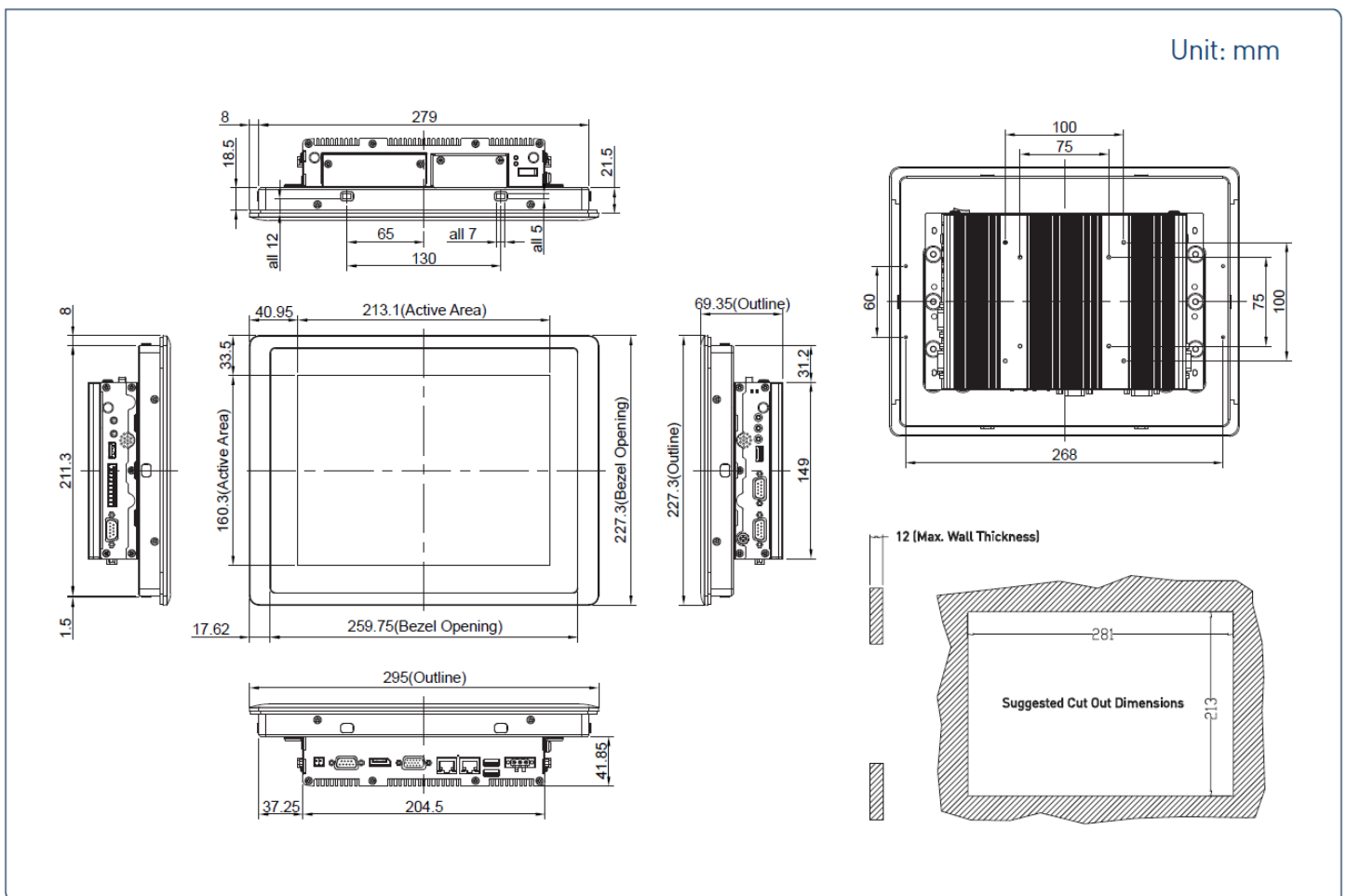

1.5.2 CS-112HC/P1101-E50 (N42) & CS-112HC-OB/P1101-E50 (N42)

Display

- LCD Size: 12.1" (4:3)
- Max. Resolution: 1024 x 768
- Brightness (cd/m²): 1500
- Contrast Ratio: 700 : 1
- LCD Color: 16.2M
- Pixel Pitch (mm): 0.24 (H) x 0.24 (V)
- Viewing Angle (H-V): 160 / 160
- Backlight MTBF: 50000 hrs. (LED Backlight)

Touch

- Projected Capacitive Touch

Processor System

- Onboard Intel® Atom® x7-E3950 Quad Core Processor, up to 2.00 GHz
- Onboard Intel® Pentium® N4200 Quad Core Processor, up to 2.50 GHz

Memory

- 1x DDR3L 1333/1600/1866 MHz 204-Pin SO-DIMM Socket
- Supports up to 8GB (un-buffered and non-ECC)

Graphics

- Integrated Intel® HD Graphics 505
- Supports Triple Independent Display (via VGA & DisplayPort outputs)

Audio Codec

- Realtek ALC888-GR

External I/O Interface

- 1x VGA (1920 x 1200 @60Hz)
- 1x DisplayPort (4K x 2K @60Hz)
- 2x GbE LAN (Supports WoL, Teaming, Jumbo Frame & PXE), RJ45
 - GbE1: Intel® I210AT
 - GbE2: Intel® I210AT
- 4x USB 3.0 (Type A)
- 4x RS-232/422/485 with Auto Flow Control (Supports 5V/12V), DB9
- 1x Speaker-out & 1x Mic-in, Phone Jack 3.5mm
- 1x ATX Power On/Off Button
- 1x Reset Button
- 1x AT/ATX Mode Switch
- 1x Clear CMOS Switch
- 1x Remote Power On/Off Connector, 2-pin Terminal Block
- 8x Isolated DIO (4x DI/4x DO), 10-Pin Terminal Block

Storage

- 1x 2.5" HDD/SSD Drive Bay (SATA 3.0)
- 1x mSATA Socket (SATA 3.0, Shared by Mini-PCIe Socket)

Expansion

- 2x Full-size Mini-PCIe Socket
- 1x SIM Socket
- Supports Control Function Module (CFM) Technology
 - Optional CFM IGN Module for Power Ignition Function
 - Optional CFM PoE Module for Power over Ethernet Function
- Supports Convertible Display System (CDS) Technology
- 4x Antenna Holes

Other Features

- Watchdog Timer: Software Programmable Supports 1~255 sec.
- Internal Speaker AMP 2W + 2W
- OSD Function: LCD On/Off, Brightness Up, Brightness Down
- SuperCap Integrated for CMOS Battery-free Operation
- Supports Instant Reboot Technology (0.2 sec)

Power Requirement

- Supports AT/ATX Power Type
- 1x 3-pin Terminal Block
- Power Input Voltage 9~48VDC
- Power Adapter AC/DC 12V/5A 60W or 24V/5A 120W (Optional)

Physical

- Dimension (WxDxH, mm): 345 X 265.3 X 69.85 mm
- Weight: 4.65 kg
- Construction: Extruded Aluminum with Heavy Duty Metal
- Front Panel Construction: Flat Rugged Aluminum Die-casting Bezel
- Mounting: Panel / VESA / *Rack Mounting (*with optional mounting kit)
- Fanless Design

Environment

- Operating Temperature: -20°C to 70°C (with extended temperature peripherals; Ambient with air flow)
- Storage Temperature: -20°C to 70°C
- Relative Humidity: 90% RH @ 40°C (non-condensing)
- Shock: Operating, 15 Grms, Half-sine 11 ms Duration (w/ SSD, according to IEC60068-2-27)
- Vibration: Operating, 1.5 Grms, 5-500 Hz, 3 Axes (w/ SSD, according to IEC60068-2-64)
- IP Level: IP 65 Compliant Front Panel
- EMC: CE, FCC Class A

Protection

- Reverse Power Input Protection
- Over Voltage Protection: 58V
- Over Current Protection: 15A
- ESD Protection: +/-15kV (air), +/-8kV (contact)
- Surge Protection: 3.84 kV (impedance 12 ohm 1.2/50µs waveform)

Operating System

- Windows® 10
- Linux: Supports by project

Dimension

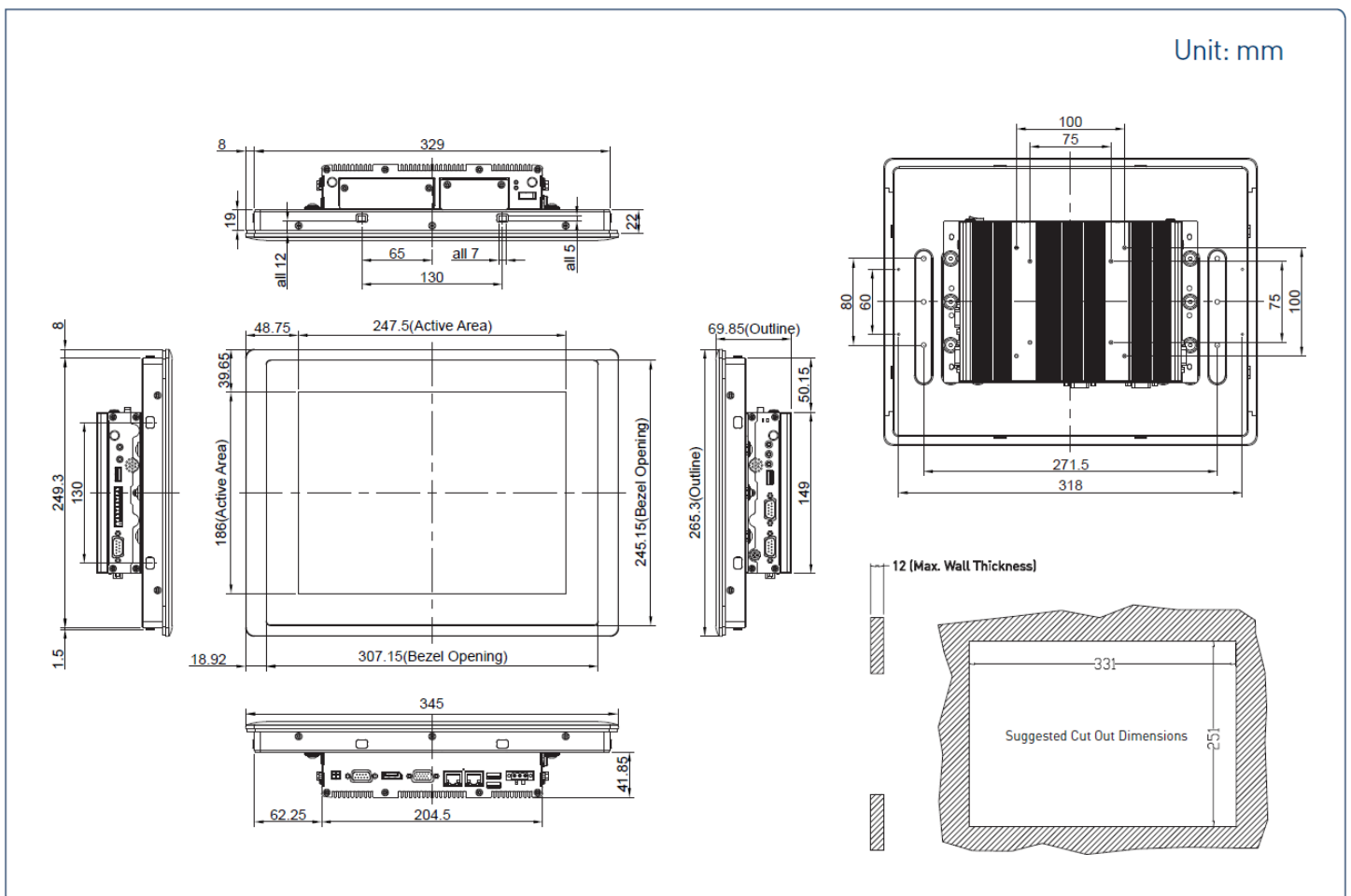

1.5.3 CS-115C/P1101-E50 (N42) & CS-115C-OB/P1101-E50 (N42)

Display

- LCD Size: 15" (4:3)
- Max. Resolution: 1024 x 768
- Brightness (cd/m²): 1600
- Contrast Ratio: 800 : 1
- LCD Color: 16.2M
- Pixel Pitch (mm): 0.297 (H) x 0.297 (V)
- Viewing Angle (H-V): 160 / 160
- Backlight MTBF: 50000 hrs. (LED Backlight)

Touch

- Projected Capacitive Touch

Processor System

- Onboard Intel® Atom® x7-E3950 Quad Core Processor, up to 2.00 GHz
- Onboard Intel® Pentium® N4200 Quad Core Processor, up to 2.50 GHz

Memory

- 1x DDR3L 1333/1600/1866 MHz 204-Pin SO-DIMM Socket
- Supports up to 8GB (un-buffered and non-ECC)

Graphics

- Integrated Intel® HD Graphics 505
- Supports Triple Independent Display (via VGA & DisplayPort outputs)

Audio Codec

- Realtek ALC888-GR

External I/O Interface

- 1x VGA (1920 x 1200 @60Hz)
- 1x DisplayPort (4K x 2K @60Hz)
- 2x GbE LAN (Supports WoL, Teaming, Jumbo Frame & PXE), RJ45
 - GbE1: Intel® I210AT
 - GbE2: Intel® I210AT
- 4x USB 3.0 (Type A)
- 4x RS-232/422/485 with Auto Flow Control (Supports 5V/12V), DB9
- 1x Speaker-out & 1x Mic-in, Phone Jack 3.5mm
- 1x ATX Power On/Off Button
- 1x Reset Button
- 1x AT/ATX Mode Switch
- 1x Clear CMOS Switch
- 1x Remote Power On/Off Connector, 2-pin Terminal Block
- 8x Isolated DIO (4x DI/4x DO), 10-Pin Terminal Block

Storage

- 1x 2.5" HDD/SSD Drive Bay (SATA 3.0)
- 1x mSATA Socket (SATA 3.0, Shared by Mini-PCIe Socket)

Expansion

- 2x Full-size Mini-PCIe Socket
- 1x SIM Socket
- Supports Control Function Module (CFM) Technology
 - Optional CFM IGN Module for Power Ignition Function
 - Optional CFM PoE Module for Power over Ethernet Function
- Supports Convertible Display System (CDS) Technology
- 4x Antenna Holes

Other Features

- Watchdog Timer: Software Programmable Supports 1~255 sec.
- Internal Speaker AMP 2W + 2W
- OSD Function: LCD On/Off, Brightness Up, Brightness Down
- SuperCap Integrated for CMOS Battery-free Operation
- Supports Instant Reboot Technology (0.2 sec)

Power Requirement

- Supports AT/ATX Power Type
- 1x 3-pin Terminal Block
- Power Input Voltage 9~48VDC
- Power Adapter AC/DC 12V/5A 60W or 24V/5A 120W (Optional)

Physical

- Dimension (WxDxH, mm): 408 X 312.4 X 72.35 mm
- Weight: 5.85 kg
- Front Panel Construction: Flat Rugged Aluminum Die-casting Bezel
- Mounting: Panel / VESA / *Rack Mounting (*with optional mounting kit)
- Fanless Design

Environment

- Operating Temperature: -20°C to 70°C (with extended temperature peripherals; Ambient with air flow)
- Storage Temperature: -20°C to 70°C
- Relative Humidity: 90% RH @ 40°C (non-condensing)
- Shock: Operating, 15 Grms, Half-sine 11 ms Duration (w/ SSD, according to IEC60068-2-27)
- Vibration: Operating, 1.5 Grms, 5-500 Hz, 3 Axes (w/ SSD, according to IEC60068-2-64)
- IP Level: IP 65 Compliant Front Panel
- EMC: CE, FCC Class A

Protection

- Reverse Power Input Protection
- Over Voltage Protection: 58V
- Over Current Protection: 15A
- ESD Protection: +/-15kV (air), +/-8kV (contact)
- Surge Protection: 3.84 kV (impedance 12 ohm 1.2/50µs waveform)

Operating System

- Windows® 10
- Linux: Supports by project

Dimension

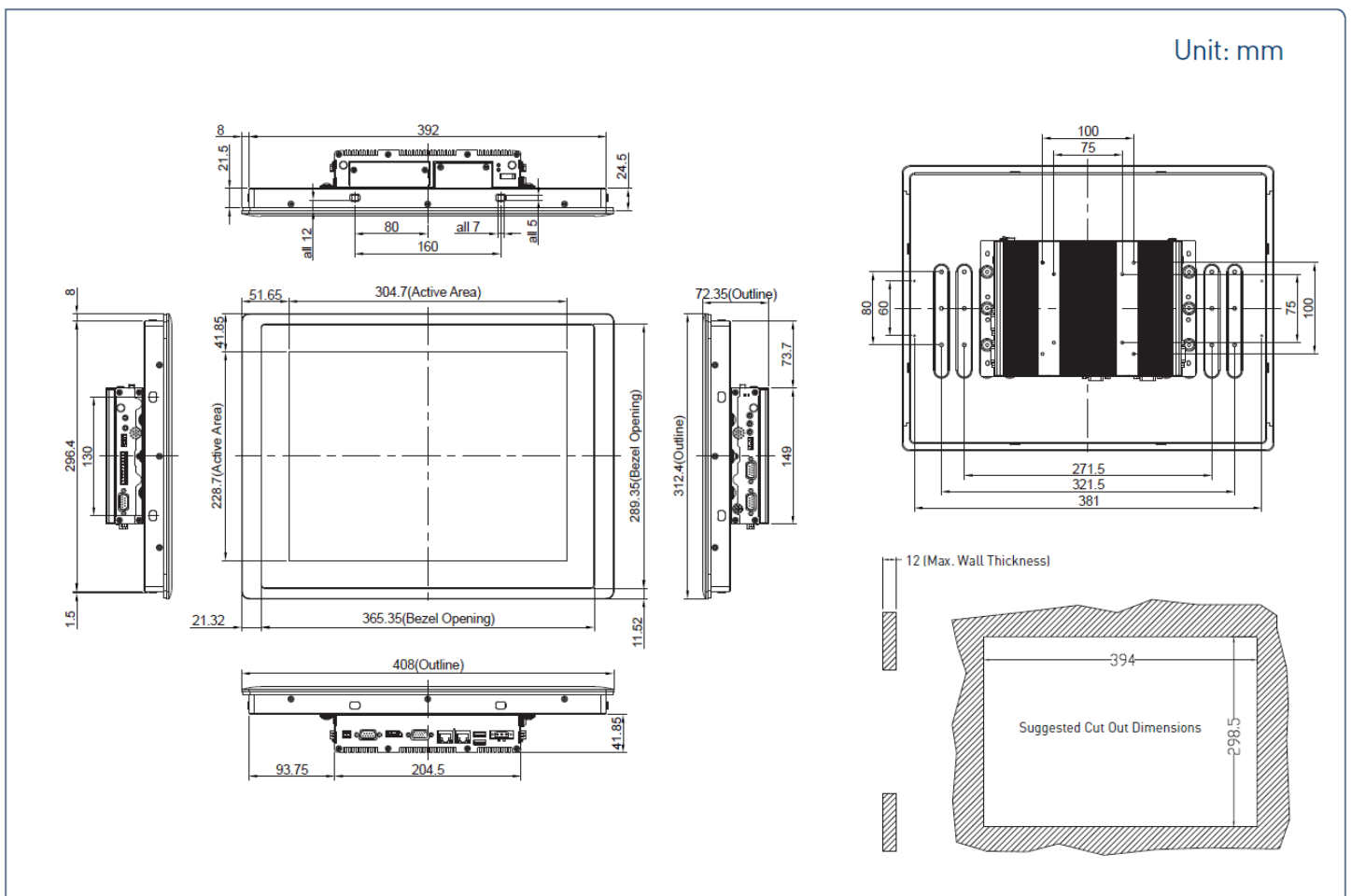

1.5.4 CS-117C/P1101-E50 (N42) & CS-117C-OB/P1101-E50 (N42)

Display

- LCD Size: 17" (5:4)
- Max. Resolution: 1280 x 1024
- Brightness (cd/m²): 1500
- Contrast Ratio: 800 : 1
- LCD Color: 16.7M
- Pixel Pitch (mm): 0.264 (H) x 0.264 (V)
- Viewing Angle (H-V): 160 / 140
- Backlight MTBF: 50000 hrs. (LED Backlight)

Touch

- Projected Capacitive Touch

Processor System

- Onboard Intel® Atom® x7-E3950 Quad Core Processor, up to 2.00 GHz
- Onboard Intel® Pentium® N4200 Quad Core Processor, up to 2.50 GHz

Memory

- 1x DDR3L 1333/1600/1866 MHz 204-Pin SO-DIMM Socket
- Supports up to 8GB (un-buffered and non-ECC)

Graphics

- Integrated Intel® HD Graphics 505
- Supports Triple Independent Display (via VGA & DisplayPort outputs)

Audio Codec

- Realtek ALC888-GR

External I/O Interface

- 1x VGA (1920 x 1200 @60Hz)
- 1x DisplayPort (4K x 2K @60Hz)
- 2x GbE LAN (Supports WoL, Teaming, Jumbo Frame & PXE), RJ45
 - GbE1: Intel® I210AT
 - GbE2: Intel® I210AT
- 4x USB 3.0 (Type A)
- 4x RS-232/422/485 with Auto Flow Control (Supports 5V/12V), DB9
- 1x Speaker-out & 1x Mic-in, Phone Jack 3.5mm
- 1x ATX Power On/Off Button
- 1x Reset Button
- 1x AT/ATX Mode Switch
- 1x Clear CMOS Switch
- 1x Remote Power On/Off Connector, 2-pin Terminal Block
- 8x Isolated DIO (4x DI/4x DO), 10-Pin Terminal Block

Storage

- 1x 2.5" HDD/SSD Drive Bay (SATA 3.0)
- 1x mSATA Socket (SATA 3.0, Shared by Mini-PCIe Socket)

Expansion

- 2x Full-size Mini-PCIe Socket
- 1x SIM Socket
- Supports Control Function Module (CFM) Technology
 - Optional CFM IGN Module for Power Ignition Function
 - Optional CFM PoE Module for Power over Ethernet Function
- Supports Convertible Display System (CDS) Technology
- 4x Antenna Holes

Other Features

- Watchdog Timer: Software Programmable Supports 1~255 sec.
- Internal Speaker AMP 2W + 2W
- OSD Function: LCD On/Off, Brightness Up, Brightness Down
- SuperCap Integrated for CMOS Battery-free Operation
- Supports Instant Reboot Technology (0.2 sec)

Power Requirement

- Supports AT/ATX Power Type
- 1x 3-pin Terminal Block
- Power Input Voltage 9~48VDC
- Power Adapter AC/DC 12V/5A 60W or 24V/5A 120W (Optional)

Physical

- Dimension (WxDxH, mm): 450 X 350 X 76.35 mm
- Weight: 7.13 kg
- Front Panel Construction: Flat Rugged Aluminum Die-casting Bezel
- Mounting: Panel / VESA / *Rack Mounting (*with optional mounting kit)
- Fanless Design

Environment

- Operating Temperature: -20°C to 70°C (with extended temperature peripherals; Ambient with air flow)
- Storage Temperature: -20°C to 70°C
- Relative Humidity: 90% RH @ 40°C (non-condensing)
- Shock: Operating, 15 Grms, Half-sine 11 ms Duration (w/ SSD, according to IEC60068-2-27)
- Vibration: Operating, 1.5 Grms, 5-500 Hz, 3 Axes (w/ SSD, according to IEC60068-2-64)
- IP Level: IP 65 Compliant Front Panel
- EMC: CE, FCC Class A

Protection

- Reverse Power Input Protection
- Over Voltage Protection: 58V
- Over Current Protection: 15A
- ESD Protection: +/-15kV (air), +/-8kV (contact)
- Surge Protection: 3.84 kV (impedance 12 ohm 1.2/50µs waveform)

Operating System

- Windows® 10
- Linux: Supports by project

Dimension

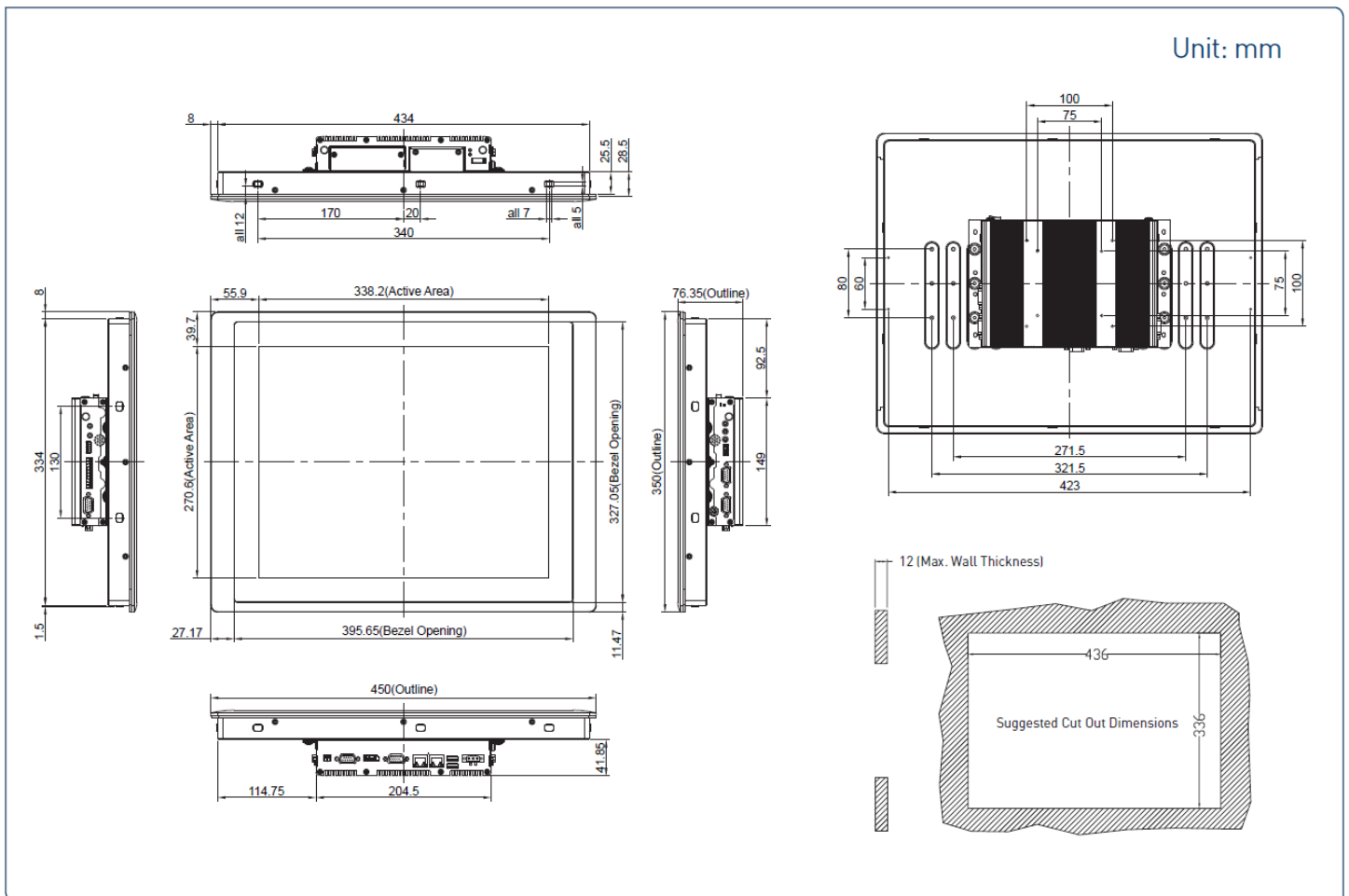

1.5.5 CS-119C/P1101-E50 (N42) & CS-119C-OB/P1101-E50 (N42)

Display

- LCD Size: 19" (5:4)
- Max. Resolution: 1280 x 1024
- Brightness (cd/m²): 1600
- Contrast Ratio: 1000 : 1
- LCD Color: 16.7M
- Pixel Pitch (mm): 0.294 (H) x 0.294 (V)
- Viewing Angle (H-V): 170 / 160
- Backlight MTBF: 50000 hrs. (LED Backlight)

Touch

- Projected Capacitive Touch

Processor System

- Onboard Intel® Atom® x7-E3950 Quad Core Processor, up to 2.00 GHz
- Onboard Intel® Pentium® N4200 Quad Core Processor, up to 2.50 GHz

Memory

- 1x DDR3L 1333/1600/1866 MHz 204-Pin SO-DIMM Socket
- Supports up to 8GB (un-buffered and non-ECC)

Graphics

- Integrated Intel® HD Graphics 505
- Supports Triple Independent Display (via VGA & DisplayPort outputs)

Audio Codec

- Realtek ALC888-GR

External I/O Interface

- 1x VGA (1920 x 1200 @60Hz)
- 1x DisplayPort (4K x 2K @60Hz)
- 2x GbE LAN (Supports WoL, Teaming, Jumbo Frame & PXE), RJ45
 - GbE1: Intel® I210AT
 - GbE2: Intel® I210AT
- 4x USB 3.0 (Type A)
- 4x RS-232/422/485 with Auto Flow Control (Supports 5V/12V), DB9
- 1x Speaker-out & 1x Mic-in, Phone Jack 3.5mm
- 1x ATX Power On/Off Button
- 1x Reset Button
- 1x AT/ATX Mode Switch
- 1x Clear CMOS Switch
- 1x Remote Power On/Off Connector, 2-pin Terminal Block
- 8x Isolated DIO (4x DI/4x DO), 10-Pin Terminal Block

Storage

- 1x 2.5" HDD/SSD Drive Bay (SATA 3.0)
- 1x mSATA Socket (SATA 3.0, Shared by Mini-PCIe Socket)

Expansion

- 2x Full-size Mini-PCIe Socket
- 1x SIM Socket
- Supports Control Function Module (CFM) Technology
 - Optional CFM IGN Module for Power Ignition Function
 - Optional CFM PoE Module for Power over Ethernet Function
- Supports Convertible Display System (CDS) Technology
- 4x Antenna Holes

Other Features

- Watchdog Timer: Software Programmable Supports 1~255 sec.
- Internal Speaker AMP 2W + 2W
- OSD Function: LCD On/Off, Brightness Up, Brightness Down
- SuperCap Integrated for CMOS Battery-free Operation
- Supports Instant Reboot Technology (0.2 sec)

Power Requirement

- Supports AT/ATX Power Type
- 1x 3-pin Terminal Block
- Power Input Voltage 9~48VDC
- Power Adapter AC/DC 12V/5A 60W or 24V/5A 120W (Optional)

Physical

- Dimension (WxDxH, mm): 510 X 389.3 X 76.35 mm
- Weight: 8.45 kg
- Front Panel Construction: Flat Rugged Aluminum Die-casting Bezel
- Mounting: Panel / VESA / *Rack Mounting (*with optional mounting kit)
- Fanless Design

Environment

- Operating Temperature: -20°C to 70°C (with extended temperature peripherals; Ambient with air flow)
- Storage Temperature: -20°C to 70°C
- Relative Humidity: 90% RH @ 40°C (non-condensing)
- Shock: Operating, 15 Grms, Half-sine 11 ms Duration (w/ SSD, according to IEC60068-2-27)
- Vibration: Operating, 1.5 Grms, 5-500 Hz, 3 Axes (w/ SSD, according to IEC60068-2-64)
- IP Level: IP 65 Compliant Front Panel
- EMC: CE, FCC Class A

Protection

- Reverse Power Input Protection
- Over Voltage Protection: 58V
- Over Current Protection: 15A
- ESD Protection: +/-15kV (air), +/-8kV (contact)
- Surge Protection: 3.84 kV (impedance 12 ohm 1.2/50µs waveform)

Operating System

- Windows® 10
- Linux: Supports by project

Dimension

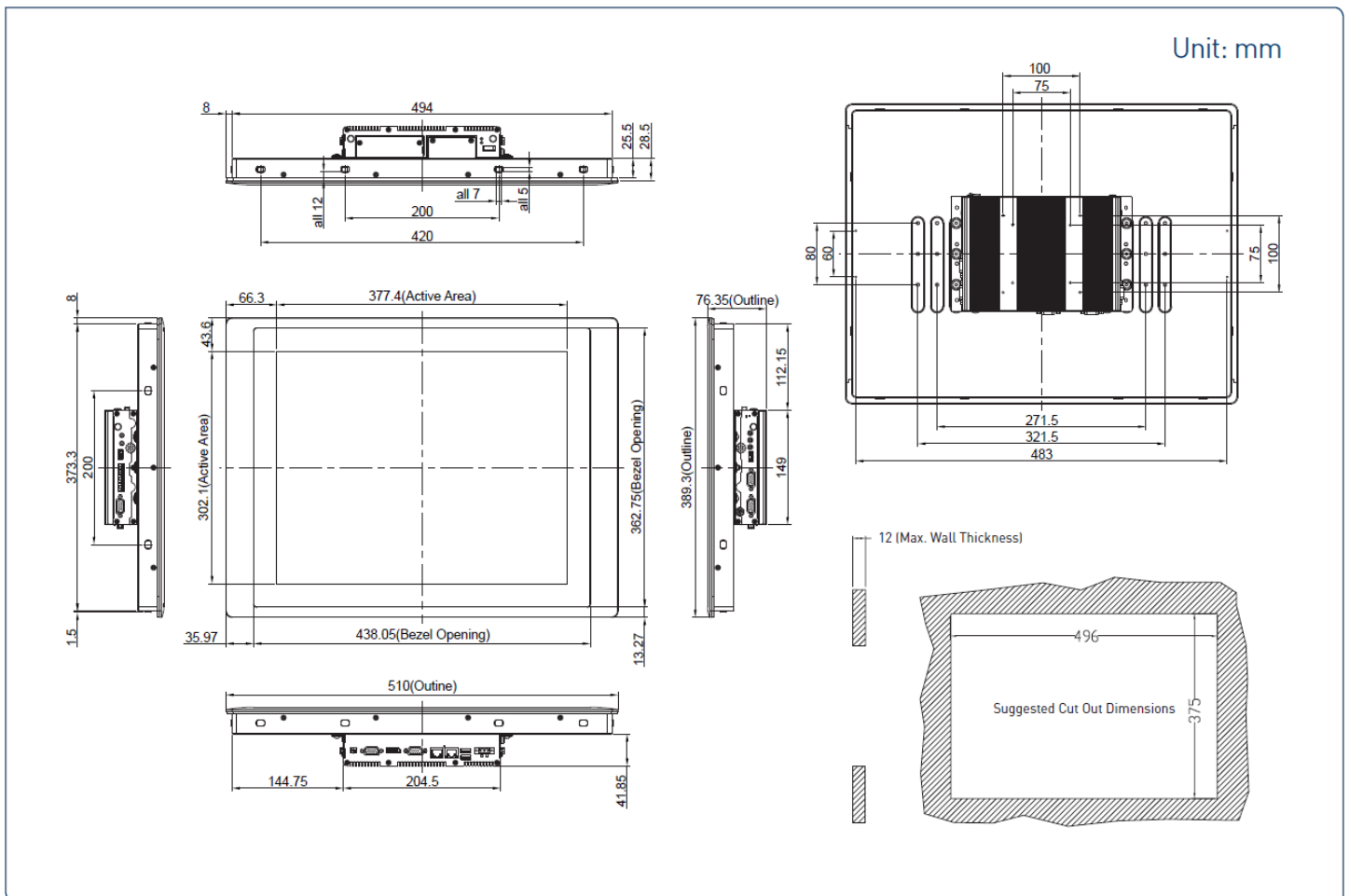

1.6 System I/O

1.6.1 Front

Power On/Off Switch

Press to power-on or power-off the system

AT/ATX Switch

Used to select AT or ATX power mode

Antenna Hole

Used to install an antenna jack

SIM Card Slot

Used to inserts a SIM card

Power LED

Indicates the power status of the system

Removable HDD

Used to inserts a 2.5" HDD/SSD

HDD LED

Indicates the status of the hard drive

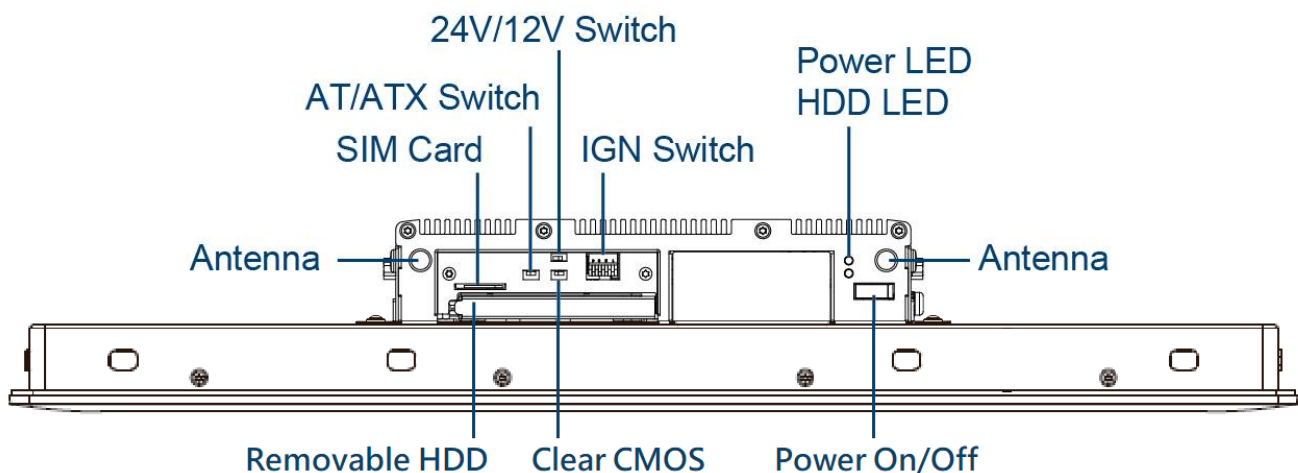

1.6.2 Rear

DC IN Terminal Block

Used to plug a DC power input with terminal block

Display Port

Used to connect the system with DisplayPort monitor

USB 3.0 port

Used to connect USB 3.0/2.0/1.1 device

COM port

COM 1 supports RS232/422/485 serial device

LAN port

Used to connect the system to a local area network

Remote Power On/Off Terminal Block

Used to plug a remote power on/off terminal block

VGA

Used to connect an analog VGA monitor

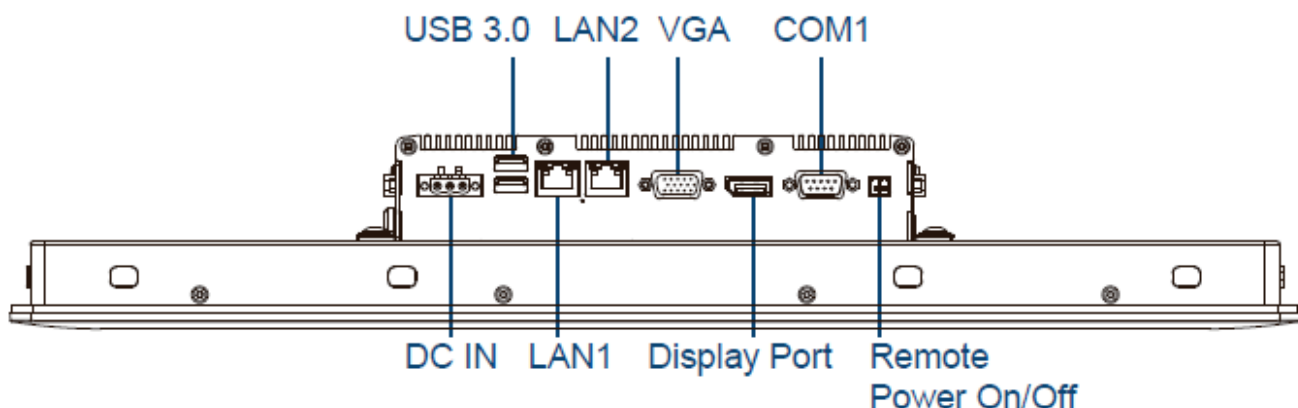

1.6.3 Side (Left)

Reset Button

Used to reset the system

Temperature LED

Indicates the temperature of the system

Antenna Hole

Used to install an antenna jack

Increase Brightness

Press to increase brightness of the screen

Decrease Brightness

Press to decrease brightness of the screen

LCD On/Off

Press to turn-on or turn-off the display

USB 3.0 port

Used to connect USB 3.0/2.0/1.1 device

COM port

COM 3/4 support RS232/422/485 serial device

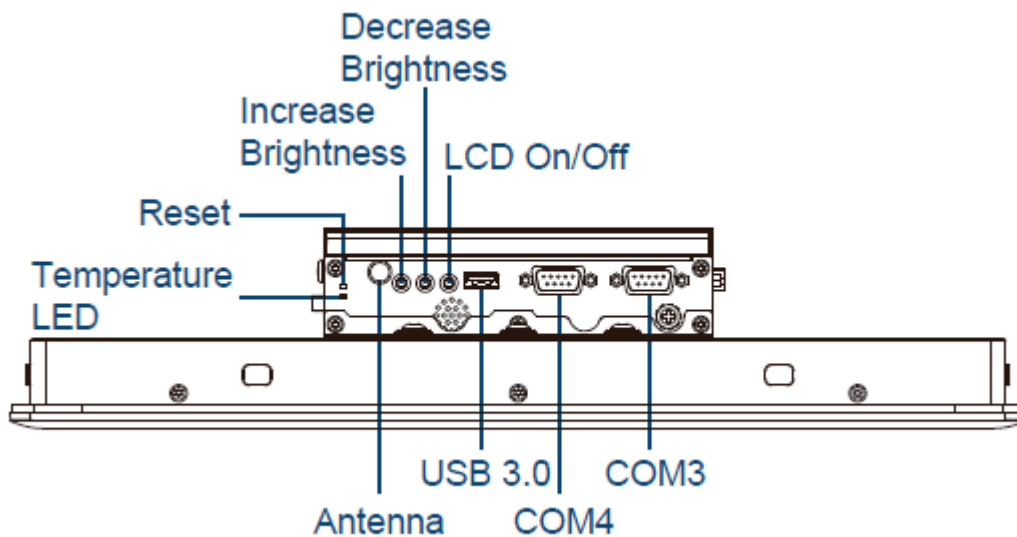

1.6.4 Side (Right)

COM port

COM 2 supports RS232/422/485 serial device

Digital I/O Terminal Block

The Digital I/O terminal block supports 4 digital input and 4 digital output

USB 3.0 port

Used to connect USB 3.0/2.0/1.1 device

Mic-In

Used to connect a microphone

Line-Out

Used to connect a speaker

Antenna Hole

Used to install an antenna jack

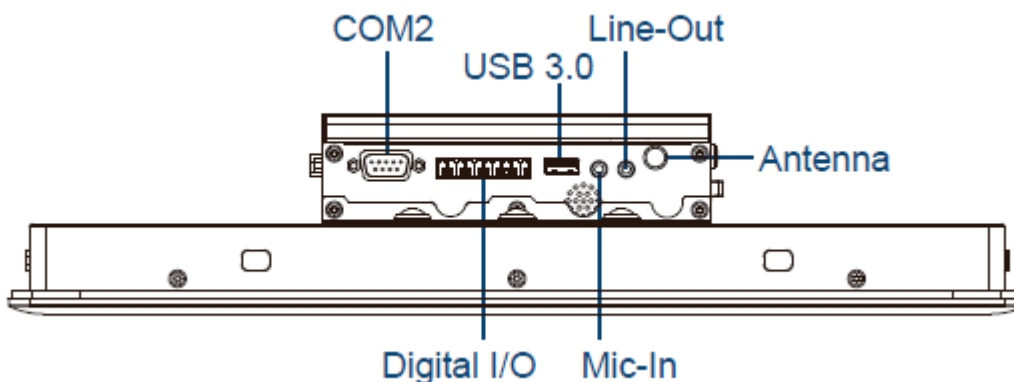

1.6.5 Top

VESA Mounting Hole

These are mounting holes for VESA mount (75x75mm and 100x100mm)

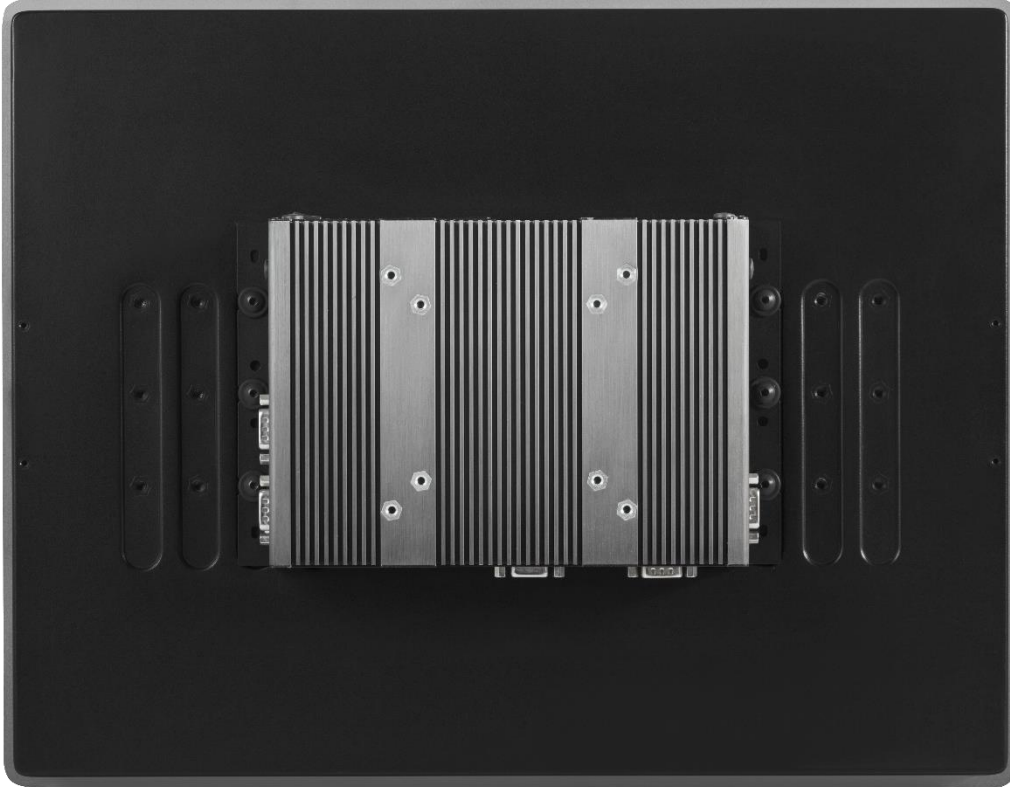



Chapter 2

System Pin Definitions and Settings

2.1 Settings

When setting the jumpers, ensure that the jumper caps are placed on the correct pins. When the jumper cap is placed on both pins, the jumper is **short**. If you remove the jumper cap, or place the jumper cap on just one pin, the jumper is **open**. Refer to below for examples of the 2-pin and 3-pin jumpers when they are short (on) and open (off).

Two-Pin Jumpers

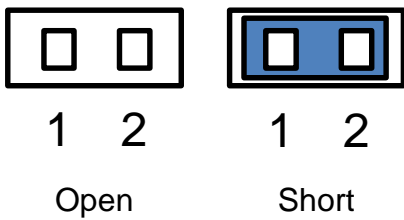

Three-Pin Jumpers

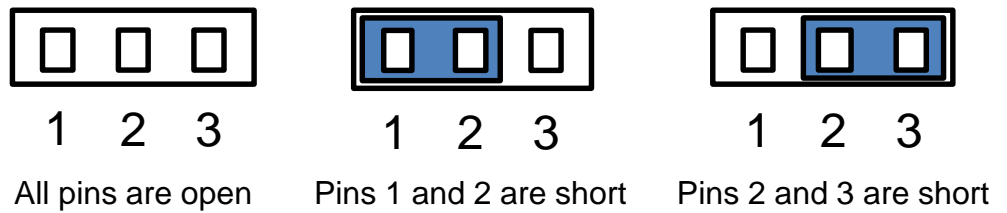

2.2 Location of the Connectors, Jumpers and Switches

2.2.1 Top View

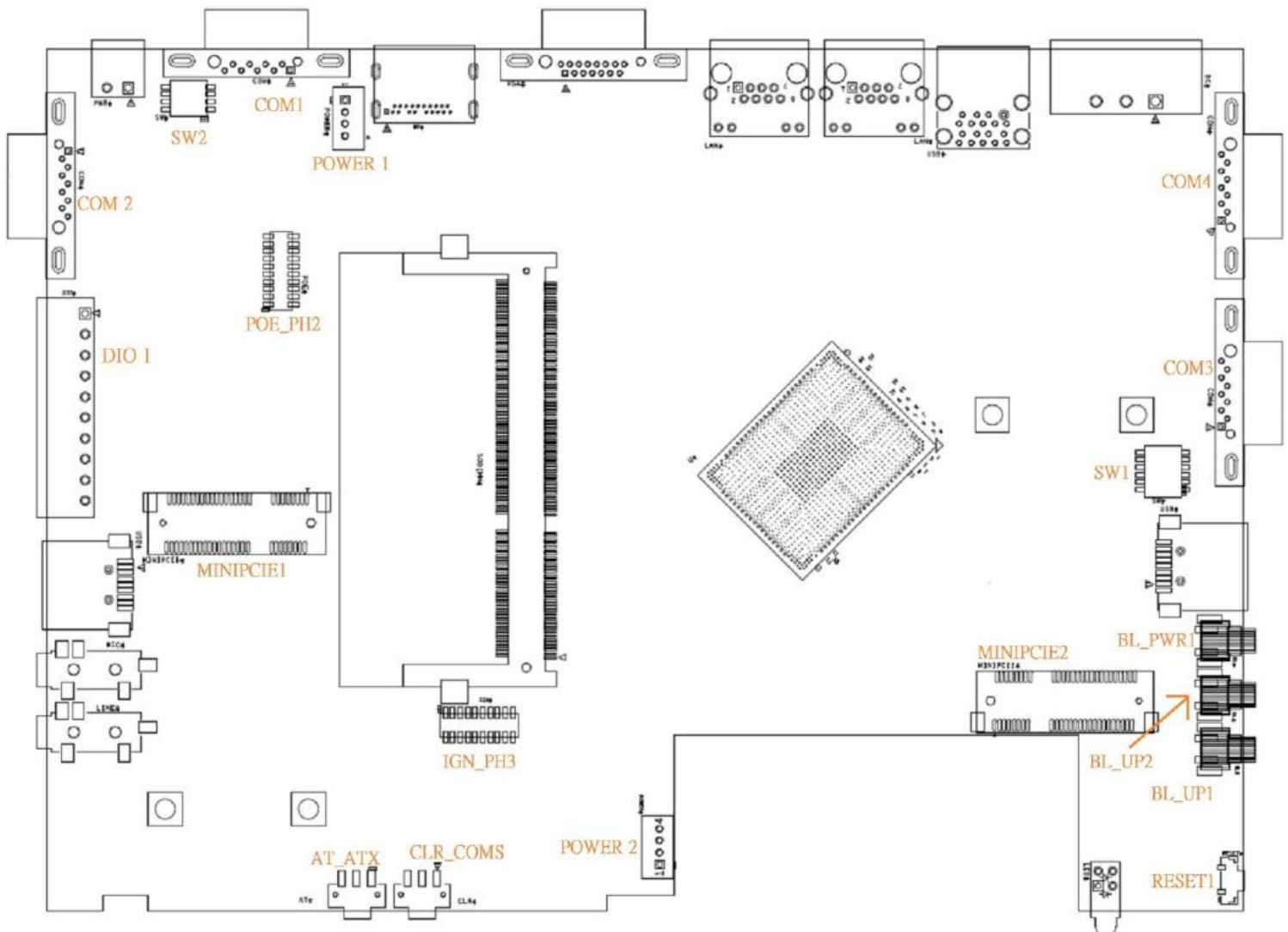

2.2.2 Bottom View

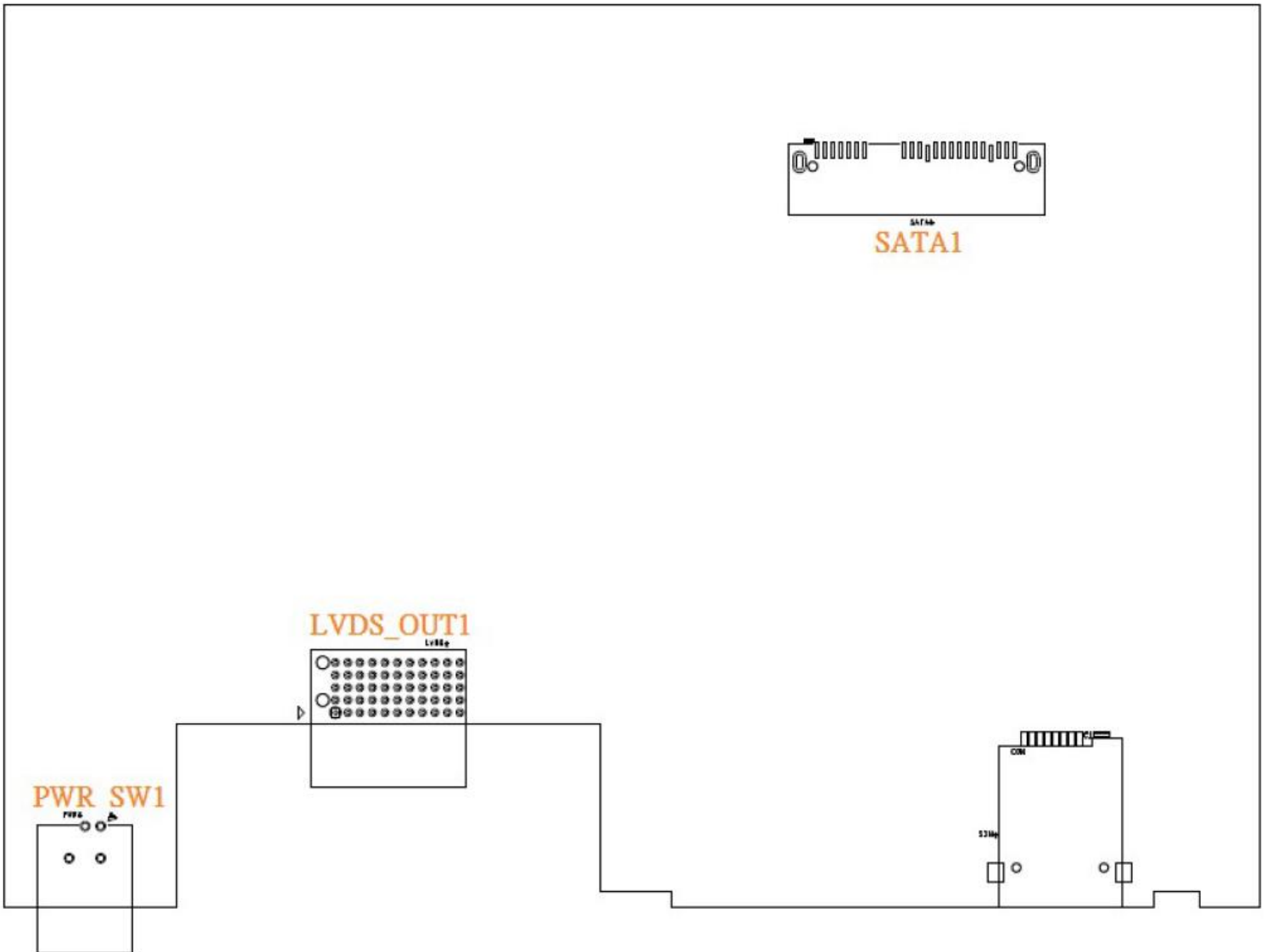

2.3 Connector / Jumper / Switch Definition

List of Connector / Jumper / Switch

Connector Location	Definition
AT_ATX	AT / ATX Power Mode Switch
CLR_CMOS	Clear CMOS Switch
RESET1	Reset Button
BL_UP1	Backlight Increase Button
BL_UP2	Backlight Decrease Button
BL_PWR1	Backlight Power On / Off Button
USB3_1 / USB3_2 / USB3_34	USB 3.0 Ports
COM1_1 / COM2_1 / COM3_1 / COM4_1	RS232 / RS422 / RS485 Connector
DC_IN1	3-pin DC 9~48V Power Input with Power Ignition Connector
LAN1	LAN Connector
LAN2	LAN Connector
VGA1	VGA Connector
DP1	DisplayPort Connector
PWR_SW2	Power Switch Connector
DIO1	4DI / 4DO Connector
MIC_IN1	Mic-in Jack
LINE_OUT1	Line-Out Jack
SW1	Super CAP SW / COM3~4 with Power Select
SW2	COM1~2 with Power Select
MINIPCIE1	Mini PCI-Express / SIM (USB3) Socket
MINIPCIE2	Mini PCI-Express / mSATA Socket
Power1 / Power2	+5V / +12V Power Output
POE_PH2	POE Board to Board Connector
IGN_PH3	IGN Board to Board Connector
PWR_SW1	Power Switch
LVDS_OUT1	LVDS Connector
SATA1	SATA with Power Connector

2.4 Definition of Switches

AT_ATX : AT / ATX Power Mode Switch

Switch	Definition
1-2 (Left)	AT Power Mode
2-3 (Right)	ATX Power Mode (Default)

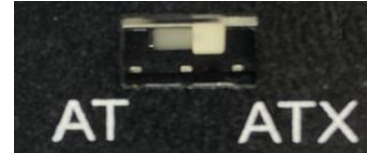

CLR_CMOS : Clear CMOS Switch

Switch	Definition
1-2 (Left)	Normal Status (Default)
2-3 (Right)	Clear CMOS



BL_UP1 : Backlight Increase

Switch	Definition
Push	Backlight Increase



BL_UP2 : Backlight Decrease

Switch	Definition
Push	Backlight Decrease



BL_PWR1 : Backlight Power On / Off

Switch	Definition
Push	Power on / off switching



RESET1 : System Reset Button

Switch	Definition
Push	Reset System



SW1: Super CAP SW / COM3~4 with Power Select

Location	Function		DIP1	DIP2
SW1	Super Cap	Enabled	ON (Default)	N/A
		Disabled	OFF	N/A

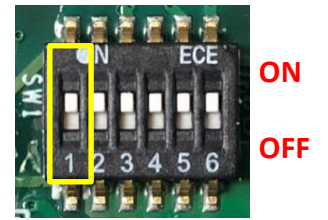

Location	Function		DIP3	DIP4
SW1	COM3	0V (RI)	ON (Default)	ON (Default)
		5V	ON	OFF
		12V	OFF	OFF

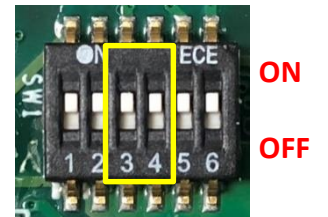

Location	Function		DIP5	DIP6
SW1	COM4	0V (RI)	ON (Default)	ON (Default)
		5V	ON	OFF
		12V	OFF	OFF

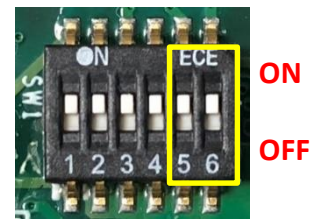

SW2: COM1~2 with Power Select

Location	Function		DIP1	DIP2
SW1	COM1	0V (RI)	ON (Default)	ON (Default)
		5V	ON	OFF
		12V	OFF	OFF

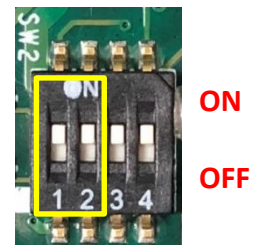

Location	Function		DIP3	DIP4
SW1	COM2	0V (RI)	ON (Default)	ON (Default)
		5V	ON	OFF
		12V	OFF	OFF

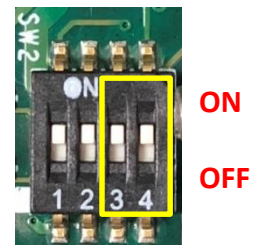

2.5 Definition of Connectors

MINIPCI1 : Mini PCI-Express Socket (Support SIM Card to Link feature)

Pin	Definition	Pin	Definition	Pin	Definition
1	WAKE#	19	NA	37	RESERVED
2	3.3V	20	3.3V	38	USB_D+
3	NA	21	GND	39	RESERVED
4	GND	22	PERST#	40	GND
5	NA	23	PERN0 (USB3RN0) / SATARP0	41	3.3V
6	1.5V	24	3.3V	42	NA
7	CLKREQ#	25	PERP0 (USB3RP0) / SATARN0	43	GND
8	SIM_VCC	26	GND	44	NA
9	GND	27	GND	45	NA
10	SIM_DATA	28	+1.5V	46	NA
11	REFCLK-	29	GND	47	NA
12	SIM_CLK	30	SMB_CLK	48	+1.5V
13	REFCLK+	31	PETN0 (USB3TN0) / SATATN0	49	NA
14	SIM_Reset	32	SMB_DATA	50	GND
15	GND	33	PETP0 (USB3TP0) / SATATP0	51	NA
16	SIM_VPP	34	GND	52	+3.3V
17	NA	35	GND		
18	GND	36	USB_D-		

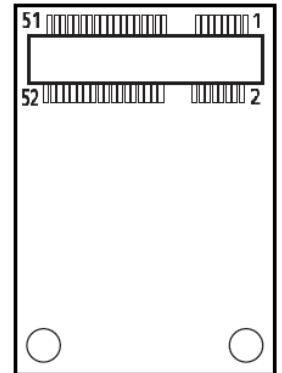

MINIPCIE2 : Mini PCI-Express Socket (Support mSATA feature)

Pin	Definition	Pin	Definition	Pin	Definition
1	WAKE#	19	NA	37	GND
2	3.3V	20	3.3V	38	USB_D+
3	NA	21	GND	39	3.3V
4	GND	22	PERST#	40	GND
5	NA	23	PERN0 / SATARP0	41	3.3V
6	1.5V	24	+3.3VAUX	42	NA
7	CLKREQ#	25	PERP0 / SATARN0	43	GND
8	NA	26	GND	44	NA
9	GND	27	GND	45	NA
10	NA	28	+1.5V	46	NA
11	REFCLK-	29	GND	47	NA
12	NA	30	SMB_CLK	48	+1.5V
13	REFCLK+	31	PETN0 / ATATN0	49	NA
14	NA	32	SMB_DATA	50	GND
15	GND	33	PETP0 / SATATP0	51	NA
16	NA	34	GND	52	+3.3V
17	NA	35	GND		
18	GND	36	USB_D-		

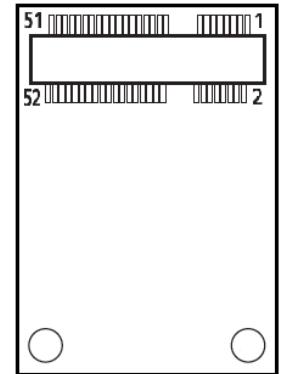

COM1_1 / COM2_1 / COM3_1 / COM4_1 : RS232 / RS422 / RS485 Connector

Connector Type: 9-pin D-Sub

Pin	RS232 Definition	RS422 / 485 Full Duplex Definition	RS485 Half Duplex Definition
1	DCD	TX-	DATA1-
2	RXD	TX+	DATA1+
3	TXD	RX+	
4	DTR	RX-	
5	GND		
6	DSR		
7	RTS		
8	CTS		
9	RI		

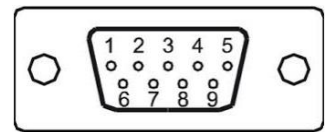

Power over Serial PIN Definitions			
Pin	RS232	RS422/485	RS485
5	GND	GND	GND
9	0/5/12V	0/5/12V	0/5/12V

LAN1 / LAN2: LAN LED Status Definition

Act LED Status	Definition	Link LED Status	Definition
Blinking Yellow	Data Activity	Steady Green	1Gbps Network Link
Off	No Activity	Steady Orange	100Mbps Network Link
		Off	10Mbps Network Link

DIO1: Digital Input / Output Connector

Connector Type: Terminal Block 1X10 10-pin, 3.5mm pitch

Pin	Definition	Pin	Definition
1	XCOM+	6	DO1
2	DI1	7	DO2
3	DI2	8	DO3
4	DI3	9	DO4
5	DI4	10	XCOM-

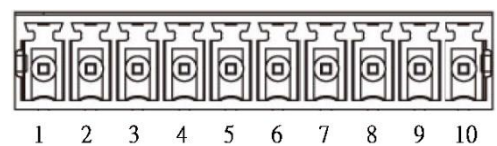

DC_IN1 : DC Power Input Connector (+9~48V)

Connector Type: Terminal Block 1X3 3-pin, 5.0mm pitch

Pin	Definition
1	+9~48VIN
2	Chassis GND
3	GND

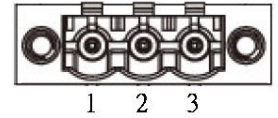
**LED1: Power / HDD Access LED Status**

LED Status	LED Color
POWER	Green
HDD	Yellow

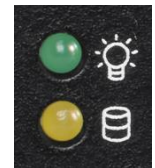
**POWER1 / 2 : Power Connector**

Connector Type: 1x4 4-pin Wafer, 2.0mm pitch

Pin	Definition
1	+5V
2	GND
3	GND
4	+12V

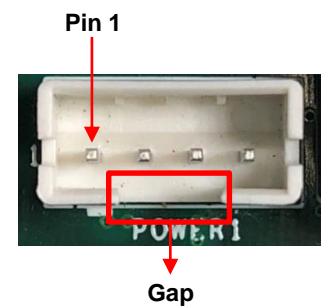
**PWR_SW2: Power On/Off Connector**

Pin	Definition
1	GND
2	PWR_SW

**(Note: Please do not apply power to the pins. This port is used to connect a switch.)**



Chapter 3

System Setup

3.1 Removing the Top Cover



WARNING

In order to prevent electric shock or system damage, before removing the chassis cover, must turn off power and disconnect the unit from power source.

1. Loosen the 8 screws of front and rear panel, then place them aside .

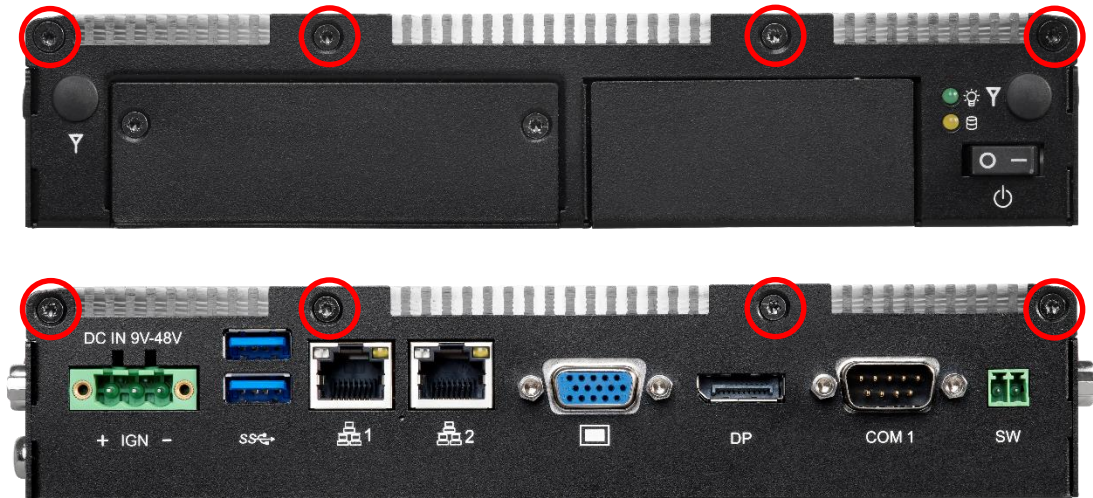

2. Remove the cover from the chassis.



3. Place the top cover gently.

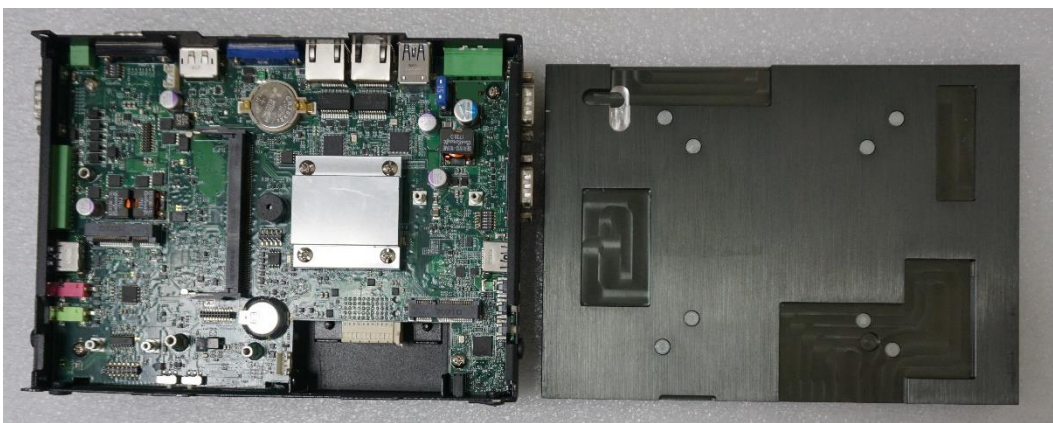

3.2 Installing a Half Size Mini PCIe Card

1. Locate the Mini PCIe slot.

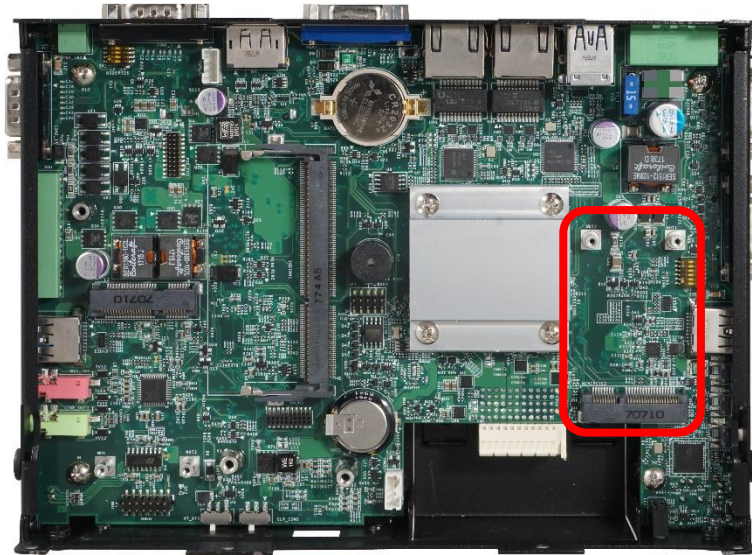

2. Use provided two screws on bracket to fasten the module and bracket together.

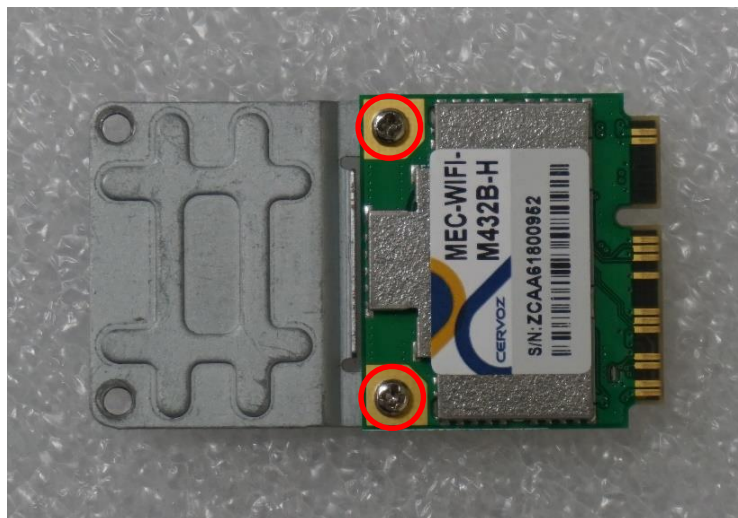

3. Tilt the Mini PCIe module at 45 degree angle and insert it to the slot until the gold-pated connector of module contacted firmly with the slot.

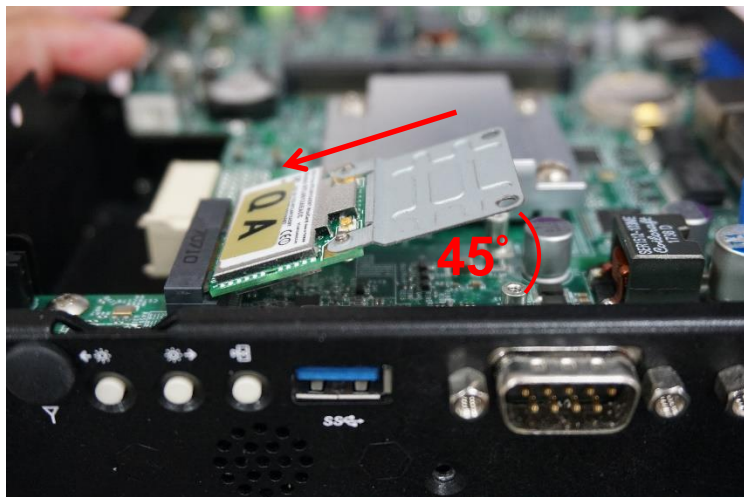

4. Press down the module and use the two screws to fix the module.

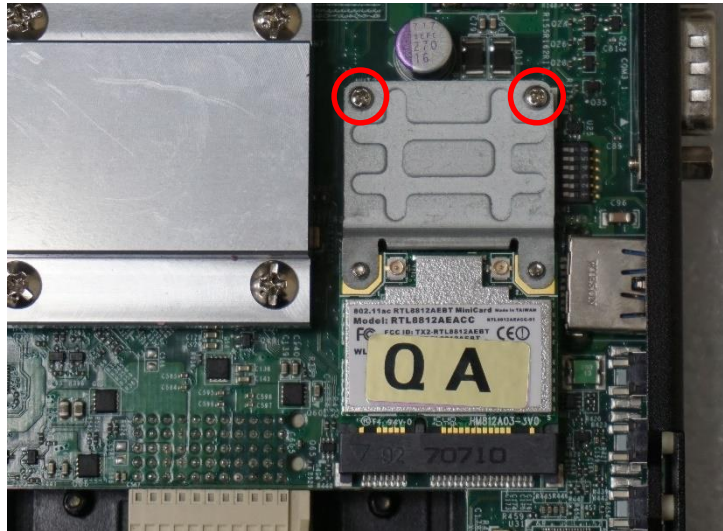

3.3 Installing a Full Size Mini PCIe Card

1. Locate the Mini PCIe slot.

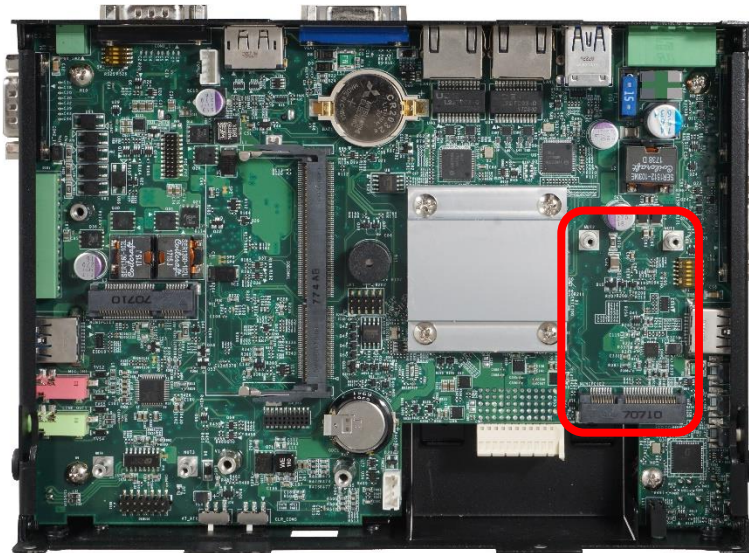

2. Tilt the Mini PCIe module at 45 degree angle and insert it to the slot until the gold-pated connector of module contacted firmly with the slot.

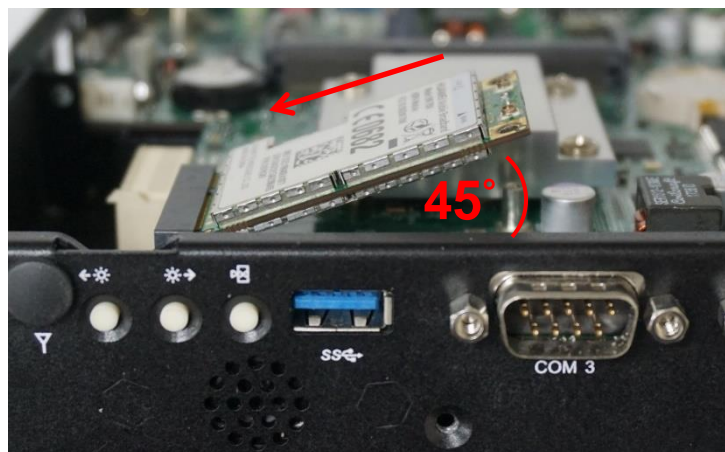

3. Press down the module and use the two screws to fix the module.

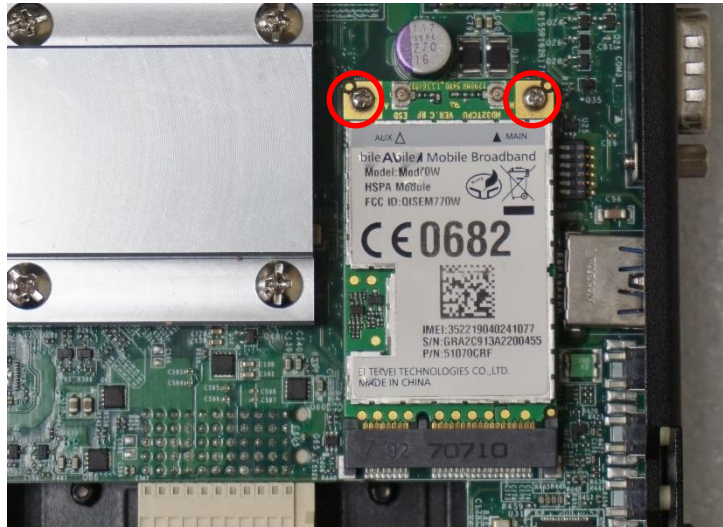

3.4 Installing Antennas

1. Remove the antenna hole covers at front panel.



2. Have antenna jack penetrate through the hole.



3. Put on washer and fasten the nut with antenna jack.

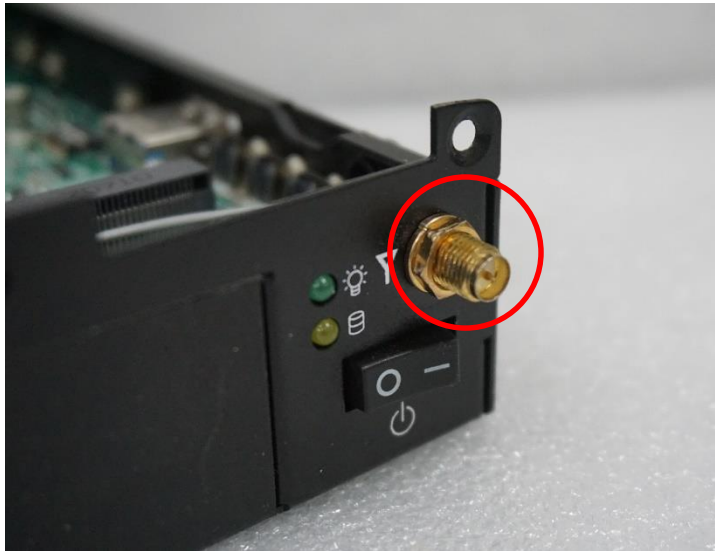

4. Assemble the antenna and antenna jack together.



5. Attach the RF connector at another end of cable onto the module.

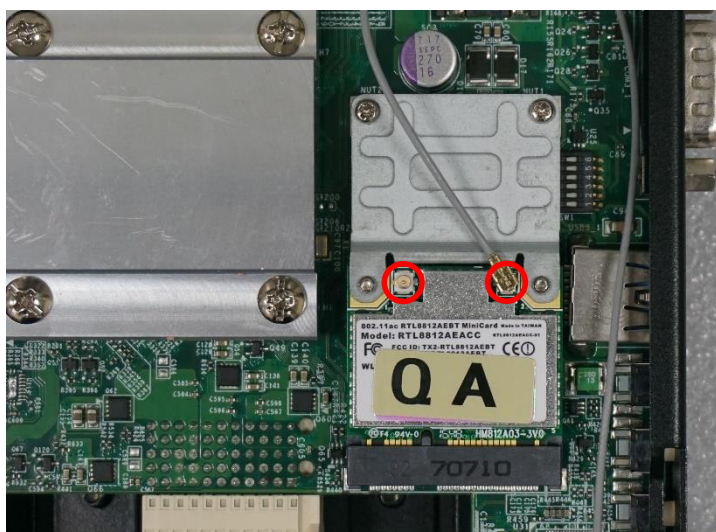

3.5 Installing a SO-DIMM

1. Locate SO-DIMM socket.

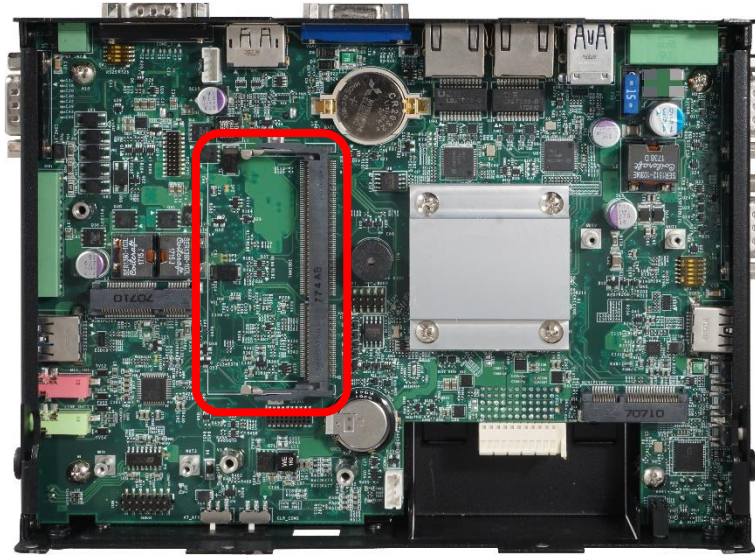

2. Tilt the SODIMM module at a 45 degree angle and insert it to SODIMM socket until the gold-pated connector of module contacted firmly with the socket.

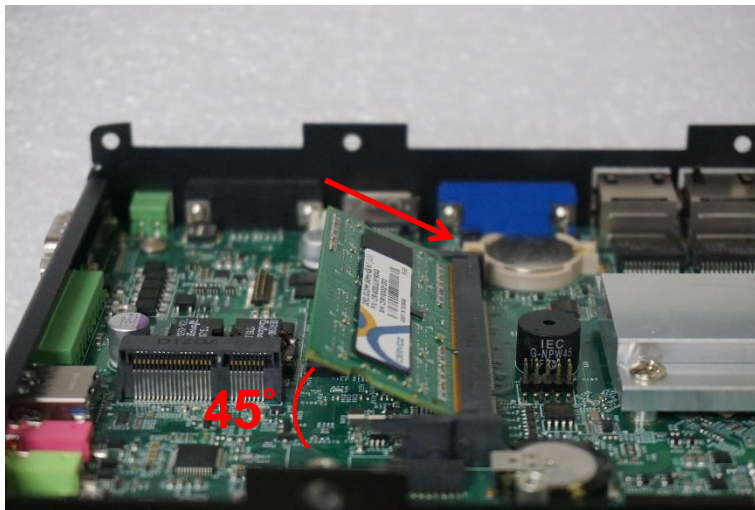

3. Press the module down until its fixed firmly by the two locking latches on each side.

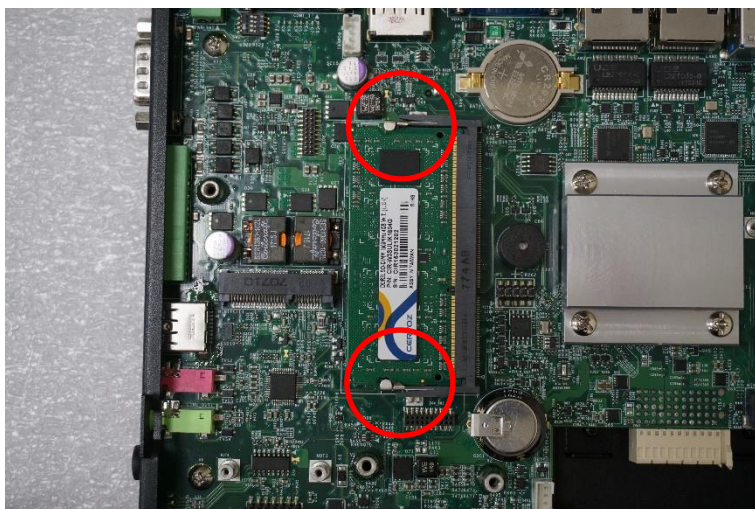

3.6 Installing CPU Thermal Pad

1. Place the thermal pad on the CPU heatsink .

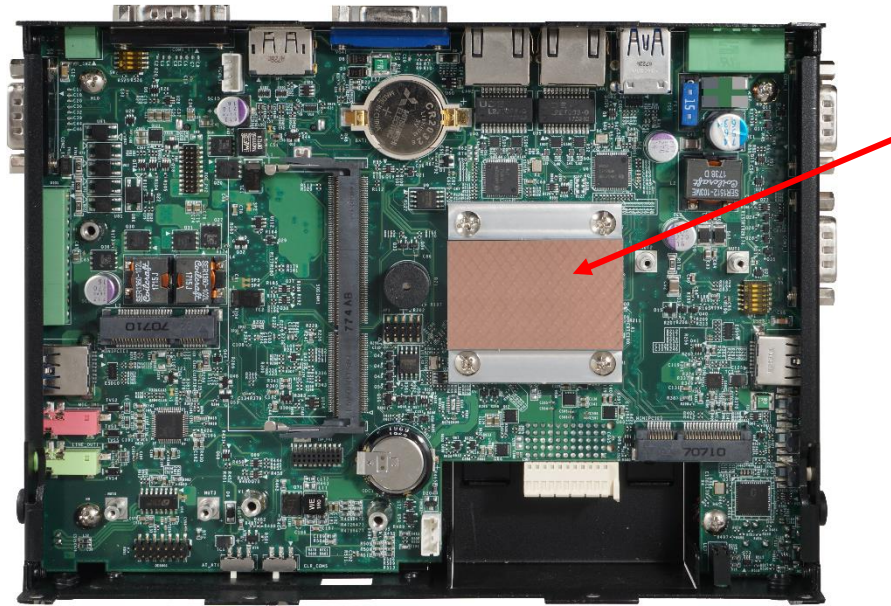

3.7 Installing the Top Cover

1. Put on the cover.

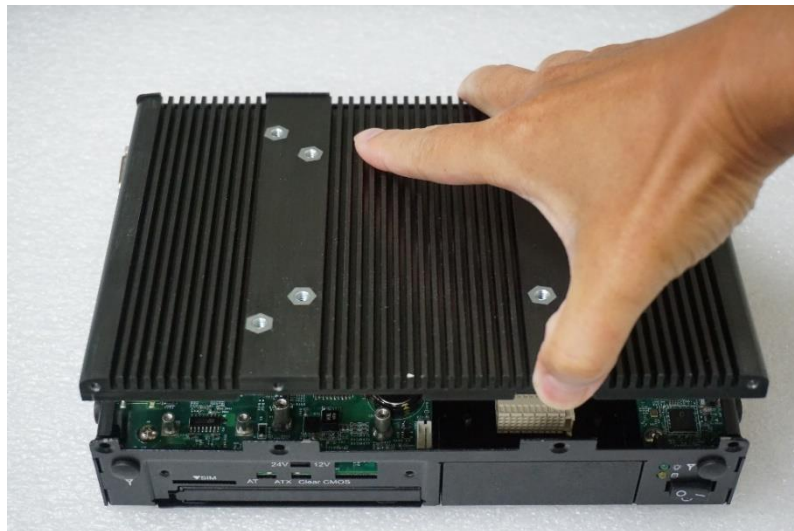

2. Fasten the 8 screws to fix the cover.

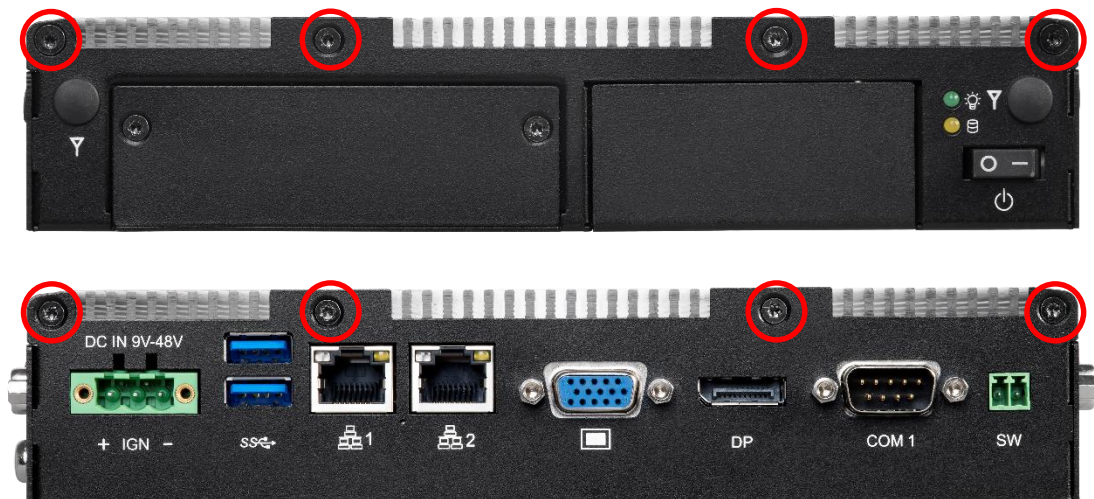

3.8 Installing a SATA Hard Drive

1. Loosen 2 screws on front panel to remove cover plate.



2. Turn over the unit to have the bottom side face up and loosen 1 screw.



3. Pull out the HDD bracket.

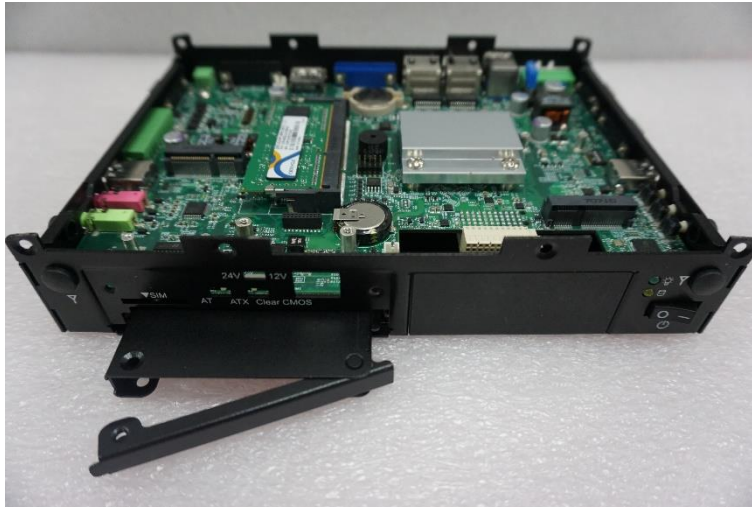

4. Make the bottom side of the HDD face up, place the HDD bracket on it. Ensure the direction of bracket is correct and use 4 provided screws to assemble HDD and HDD bracket together.



5. Align the HDD bracket with the entrance of HDD bay. And insert the HDD bracket until the connector of HDD contact the SATA connector firmly.



3.9 Installing a SIM Card

1. Loosen 2 screws on front panel to remove cover plate.

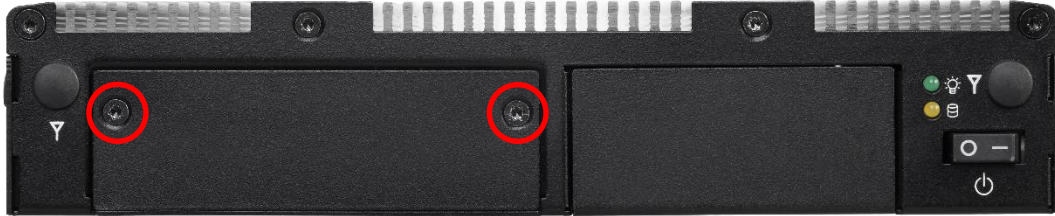

2. SIM card slot is at the front panel of the system.



3. Insert the SIM card.



3.10 Connecting with CS Display Module

1. Locate the module connector slot.

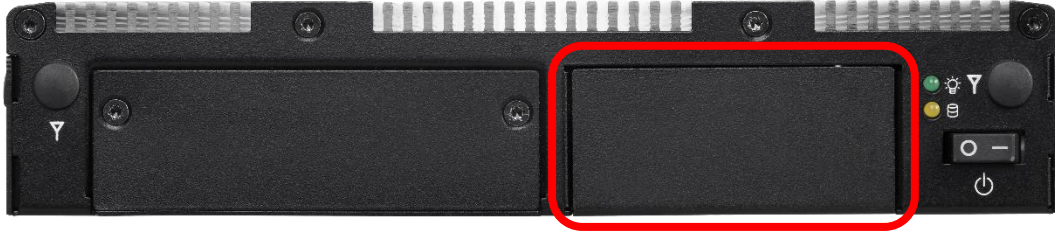

2. Turn over the unit to have the bottom side face up, loosen the 2 screws of the module connector bracket.

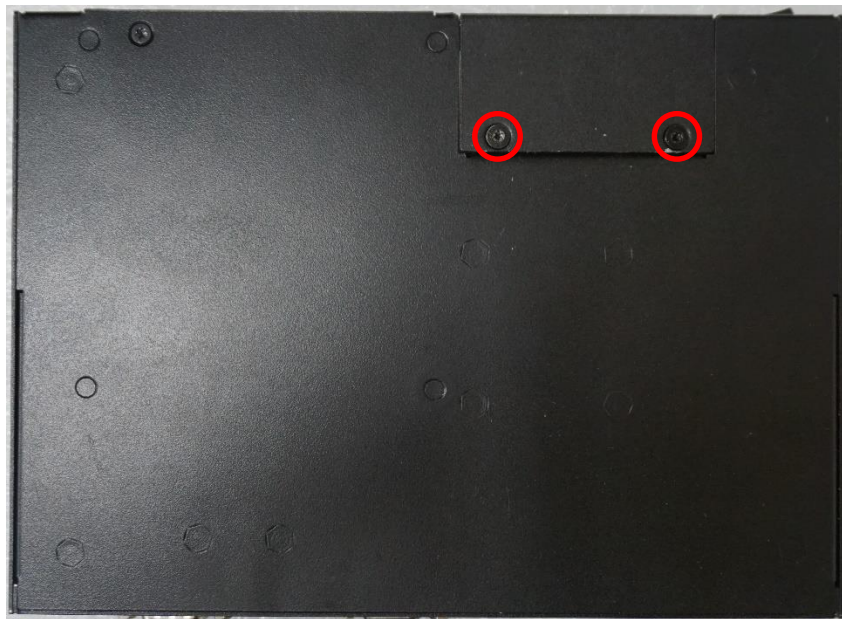

The photos shows the male connector (on display module) and female connector (on PC module)



3. Connect the module.

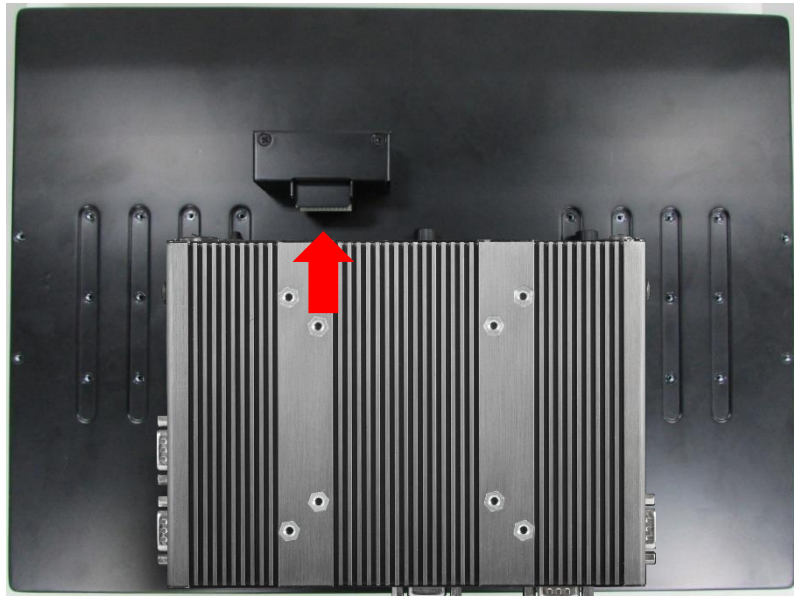

4. Fasten the 6 screws to fix the PC module on the display module.

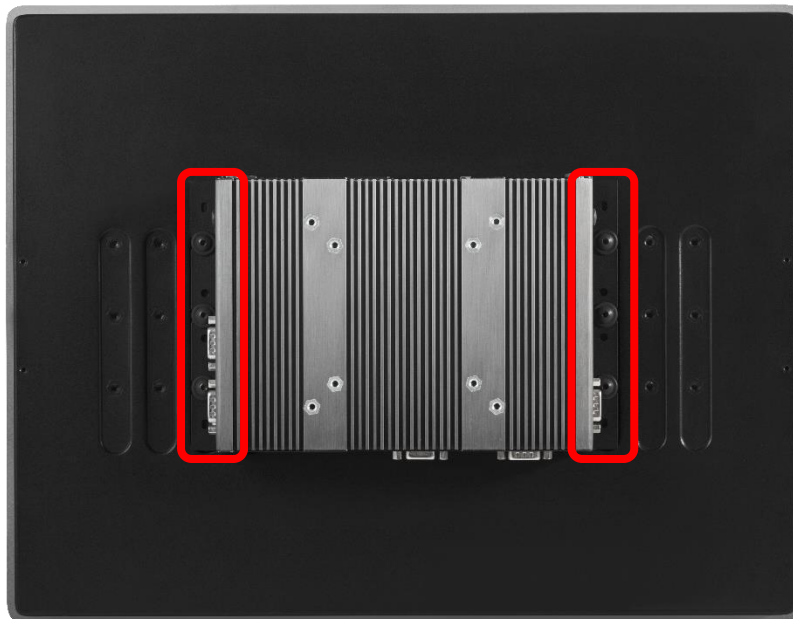

3.11 VESA Mount

The following picture indicates VESA mounting hole pattern on P1100 series, which is compliant with VESA mounting standard.

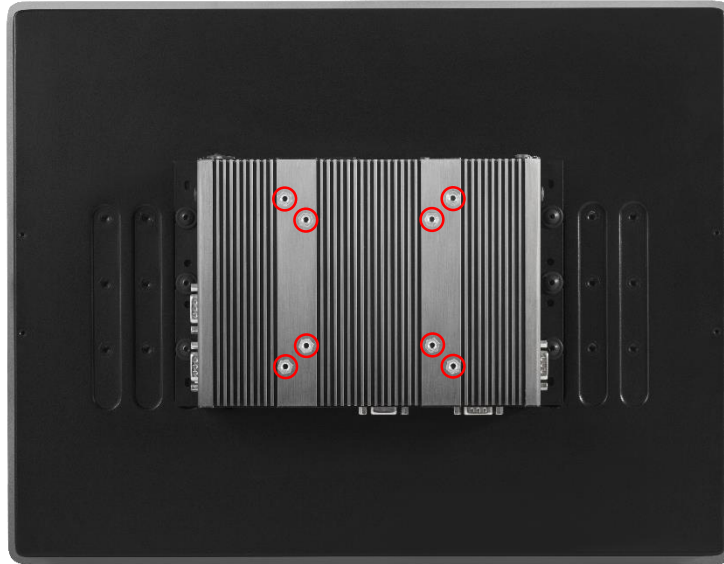

1. The following picture uses a panel PC (P1100 series +CS display module) as a demonstration. To attach the panel PC to a VESA stand, please fasten eight screws as indicated to fix it on the stand.

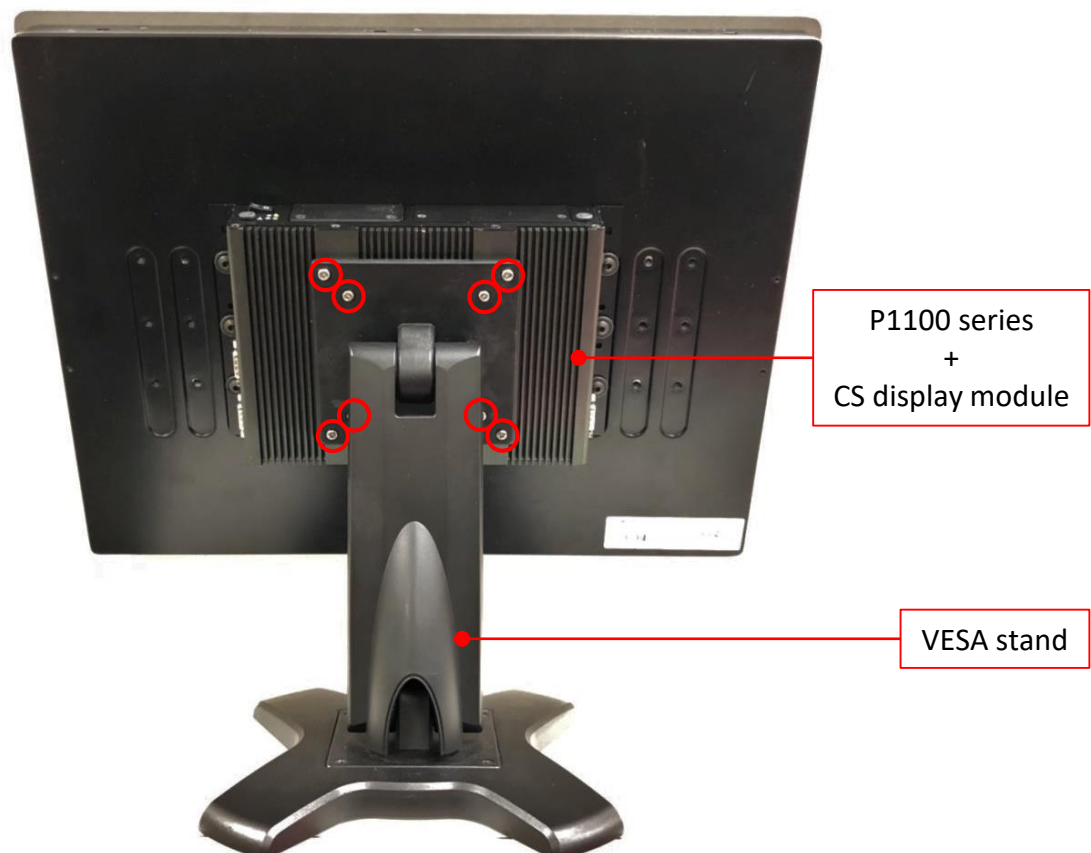

3.12 Panel Mount

Accessories provided by Cincoze are as follows.

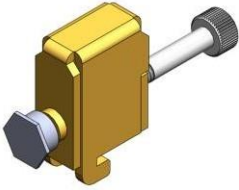

Mounting Kits

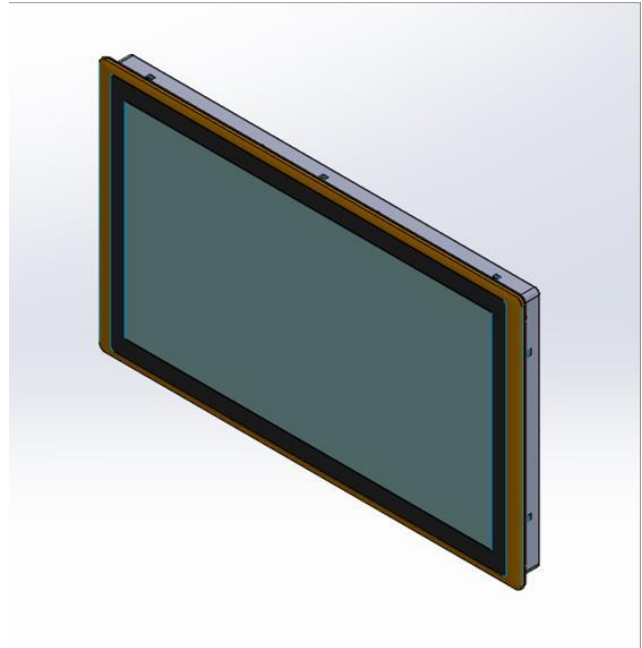

Panel Mount PPC

Before assembly, please prepare panel mount PPC and customer's fixture.

Panel Mount with customer's fixture
(Front View)

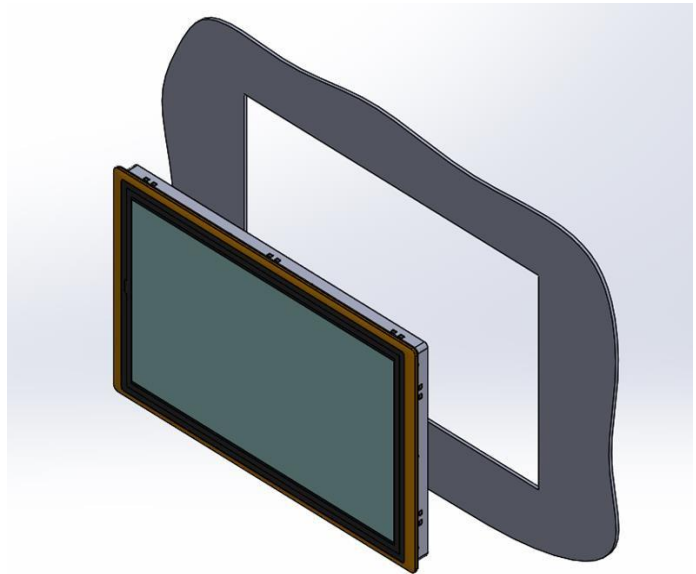

2. All mounting kits displayed are to be inserted into holes.

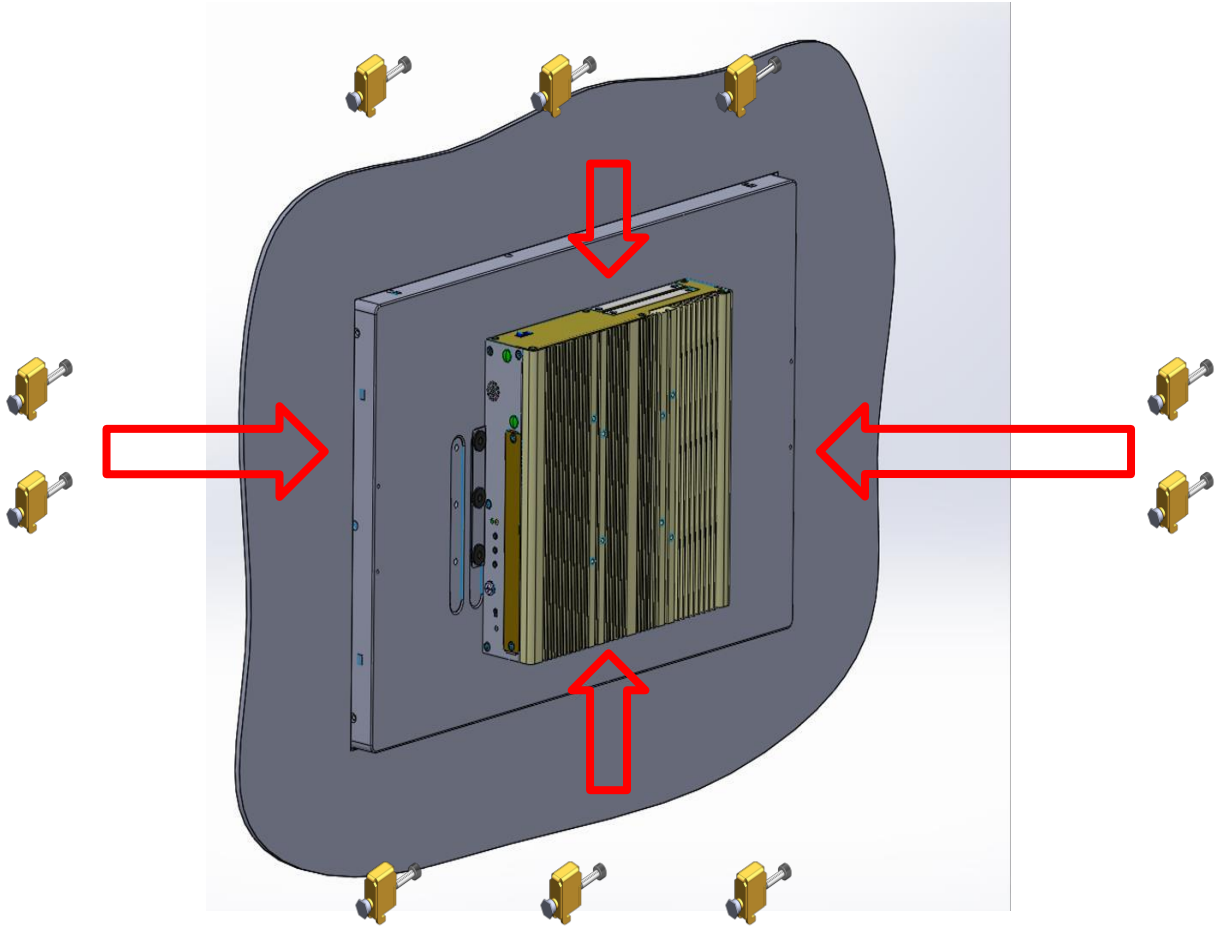

3. Installation preparation and steps.

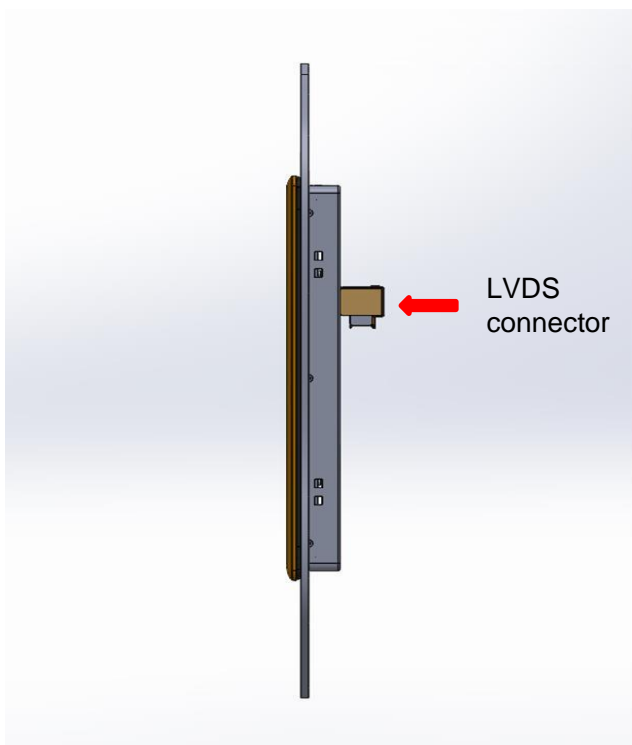

Panel mount side view with LVDS connector of CS series

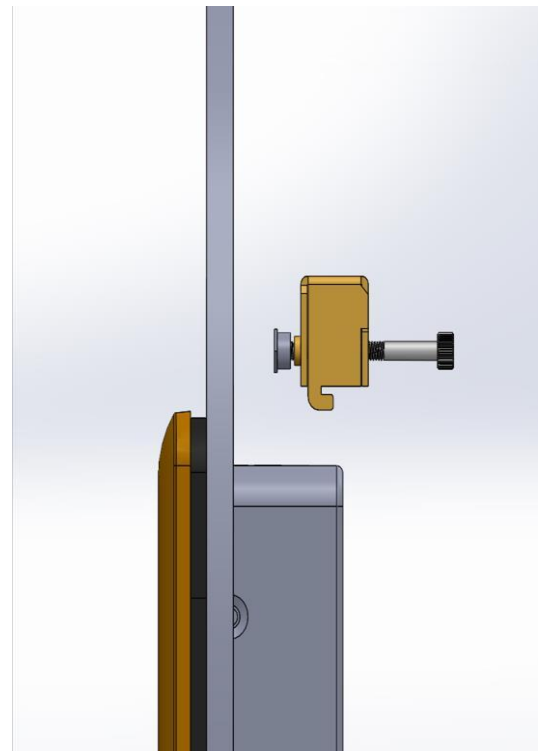

Before Mounting Kits are installed

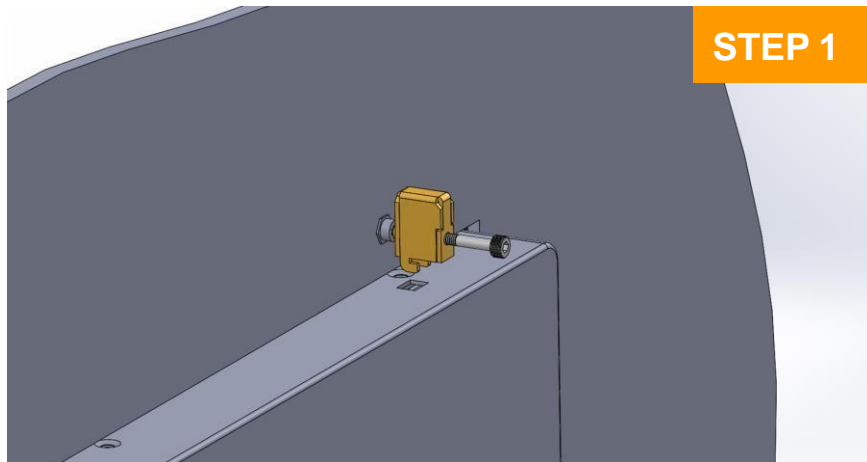

Position panel mount kits

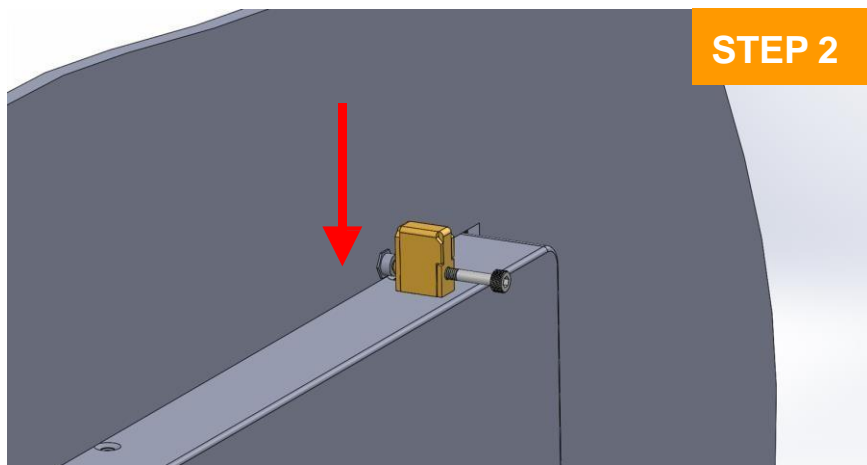

Insert the panel mounting kit into bottom hole

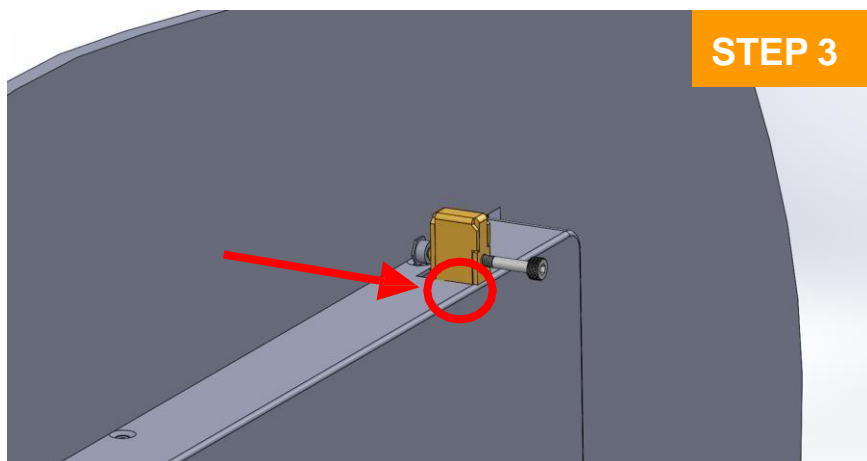

Slide the kit toward back

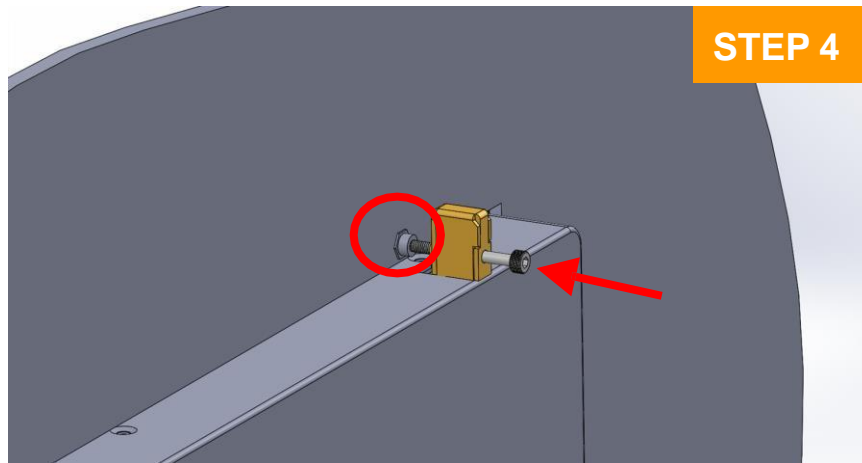

Tighten the screw forward until the front screw just touches the surface

4. Apply all mount kits to the rest of holes. And you have completed the panel mount installation, as shown below.

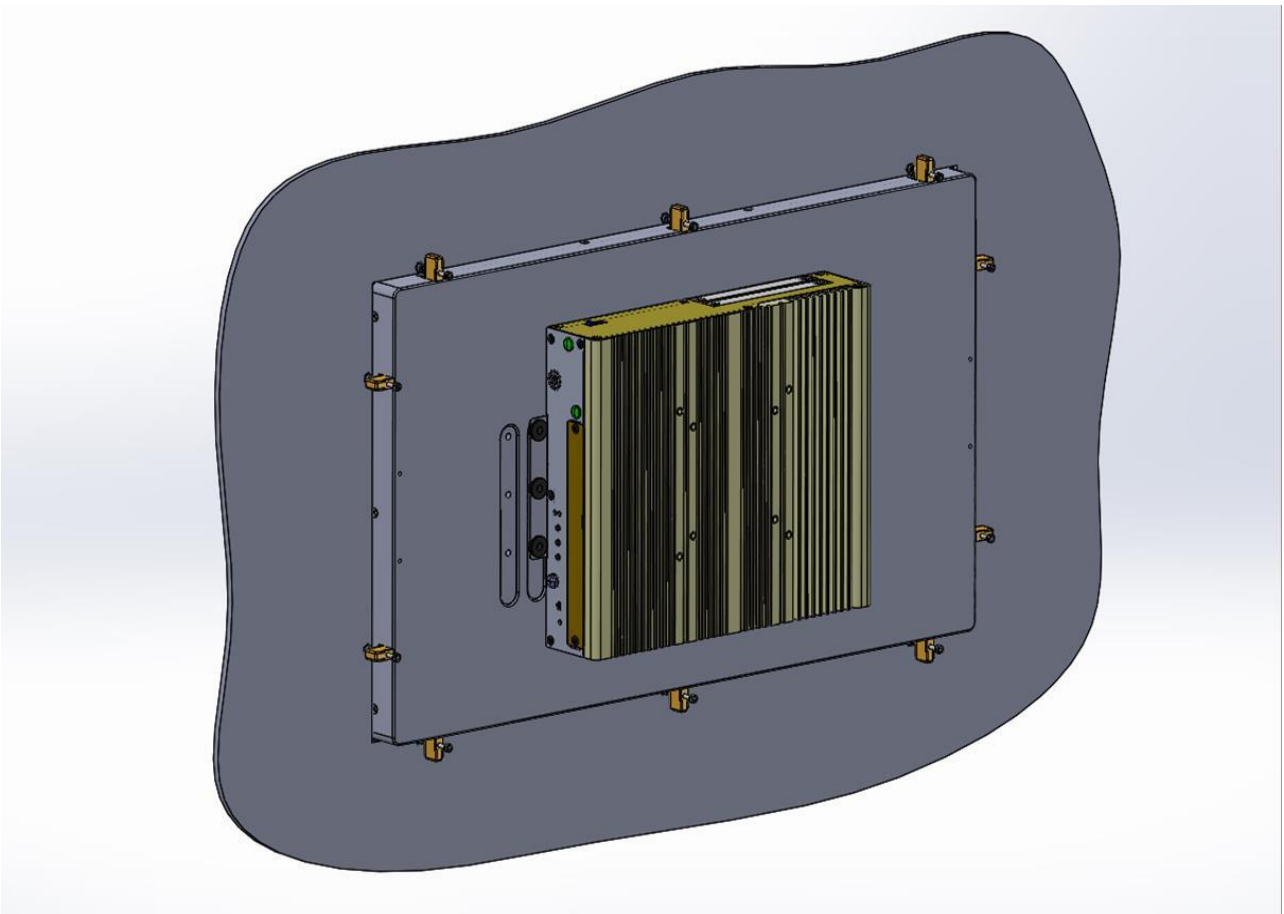



Chapter 4

BIOS Setup

4.1 BIOS Introduction

The BIOS (Basic Input/Output System) is a program located on a Flash Memory on the motherboard. When you start the computer, the BIOS program will gain control. The BIOS first operates an auto-diagnostic test called POST (power on self test) for all the necessary hardware, it detects the entire hardware device and configures the parameters of the hardware synchronization.

BIOS Setup

Power on the computer and by pressing immediately allows you to enter Setup. If the message disappears before your respond and you still wish to enter Setup, restart the system to try again by turning it OFF then ON or pressing <Ctrl>, <Alt> and <Delete> keys.

Control Keys	
<←> <→>	Move to select screen
<↑> <↓>	Move to select item
<Esc>	Quit the BIOS Setup
<Enter>	Select item
<Page Up/+>	Increases the numeric value or makes changes
<Page Down/->	Decreases the numeric value or makes changes
<Tab>	Select setup fields
<F1>	General help
<F2>	Previous value
<F3>	Load Optimized defaults
<F10>	Save configuration and Exit

Main Menu

The main menu lists the setup functions you can make changes to. You can use the arrow keys (↑↓) to select the item. The on-line description of the highlighted setup function is displayed at the bottom of the screen.

Sub-Menu

If you find a right pointer symbol appears to the left of certain fields that means a sub-menu can be launched from this field. A sub-menu contains additional options for a field parameter. You can use arrow keys (↑↓) to highlight the field and press <Enter> to call up the sub-menu. Then you can use the control keys to enter values and move from field to field within a sub-menu. If you want to return to the main menu, just press the <Esc >.

4.2 Main Setup

Press key to enter BIOS CMOS Setup Utility, the Main Menu (as shown below) will appear on the screen. Use arrow keys to move among the items and press <Enter> to accept or enter a sub-menu.

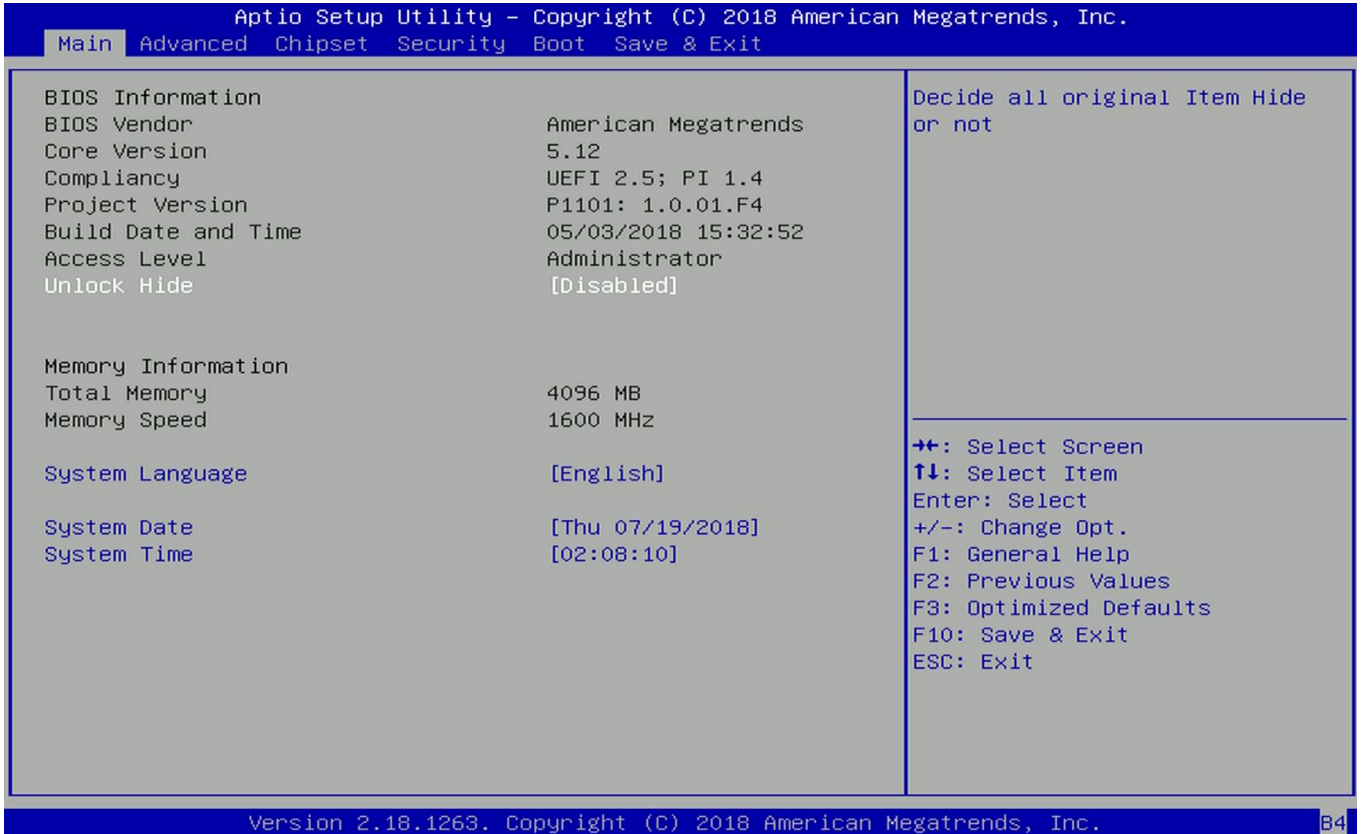

■ System Date

Set the date. Please use <Tab> to switch between date elements.

■ System Time

Set the time. Please use <Tab> to switch between time elements.

4.3 Advanced Setup

This section allows you to configure and improve your system and allows you to set up some system features according to your preference.

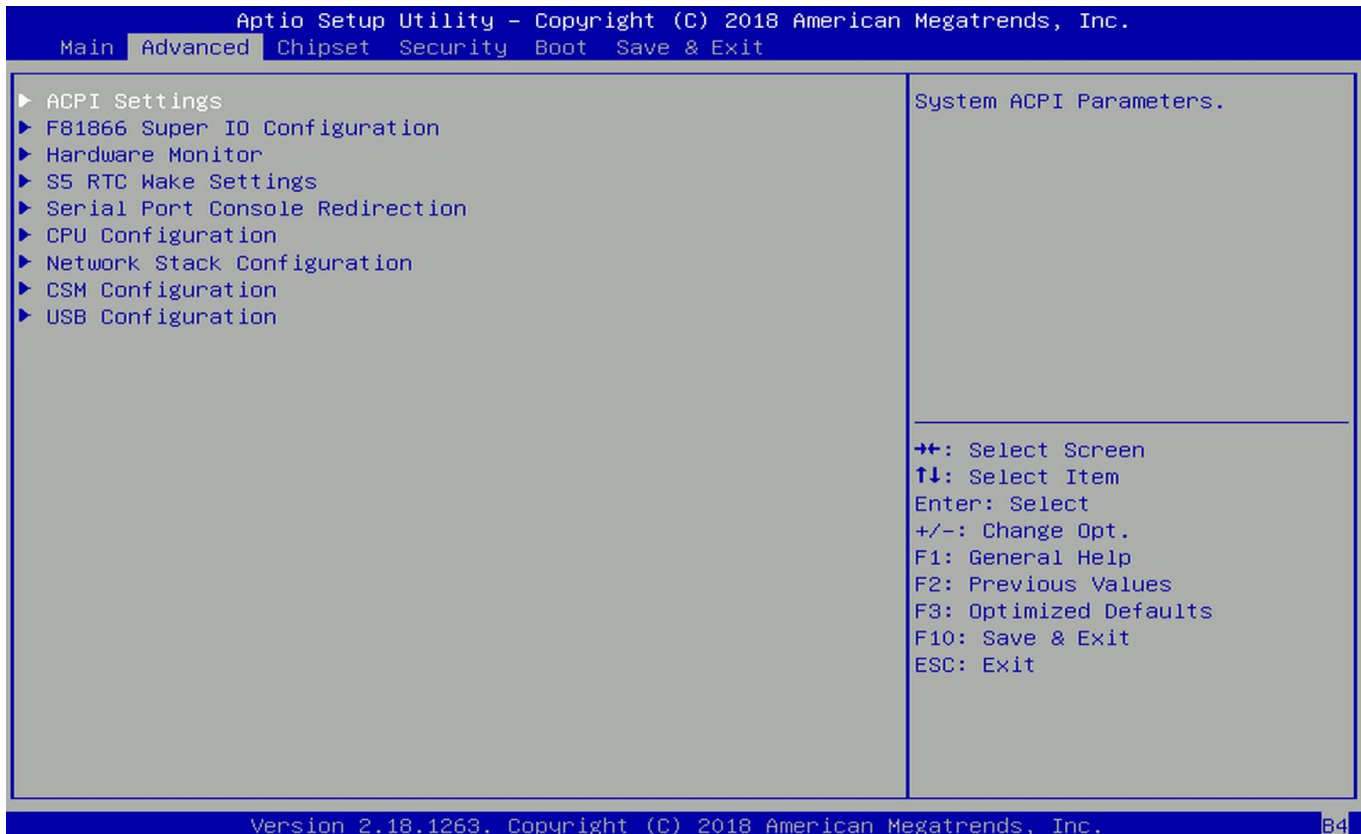

4.3.1 ACPI Settings

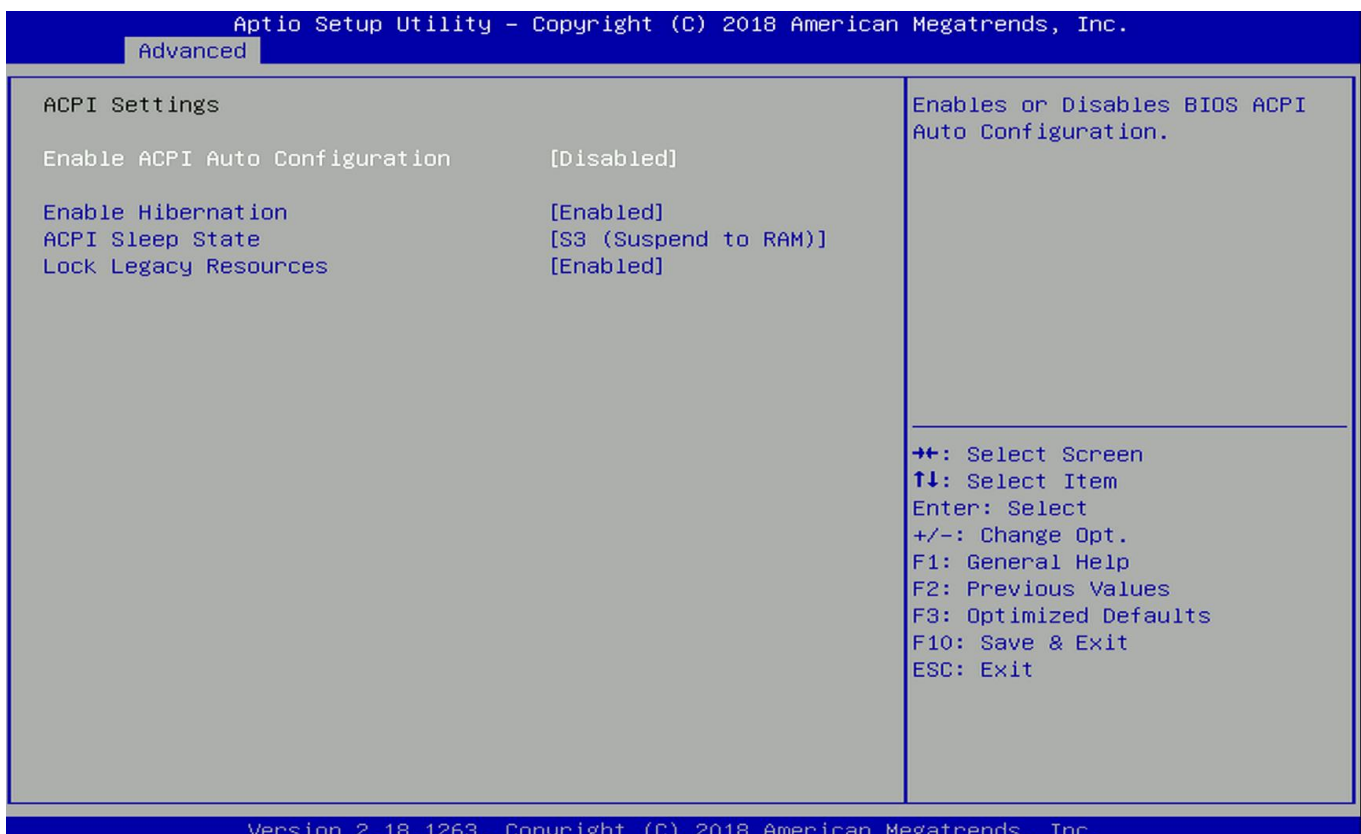

■ Enable ACPI Auto Configuration [Disabled]

Enables or disables BIOS Advanced Configuration Power Interface® (ACPI) auto configuration.

■ Enable Hibernation [Enabled]

Enables or disables system ability to hibernate state (OS/S4 state). This option may not be effective with some OS.

■ ACPI Sleep State [S3 (Suspend to RAM)]

Allows users to select the highest Advanced Configuration Power Interface® (ACPI) sleep state that system will enter when suspend button is pressed.

[Suspend Disabled]: Disables entering suspend state.

[S3 (suspend to RAM)]: Enables suspend to RAM state.

■ Lock Legacy Resources [Enabled]

Enables or disables Lock Legacy Resources.

4.3.2 F81866 Super IO Configuration

Set Parameters of Serial Ports. User can Enable/Disable the serial port and Select an optimal settings for the Super IO Device

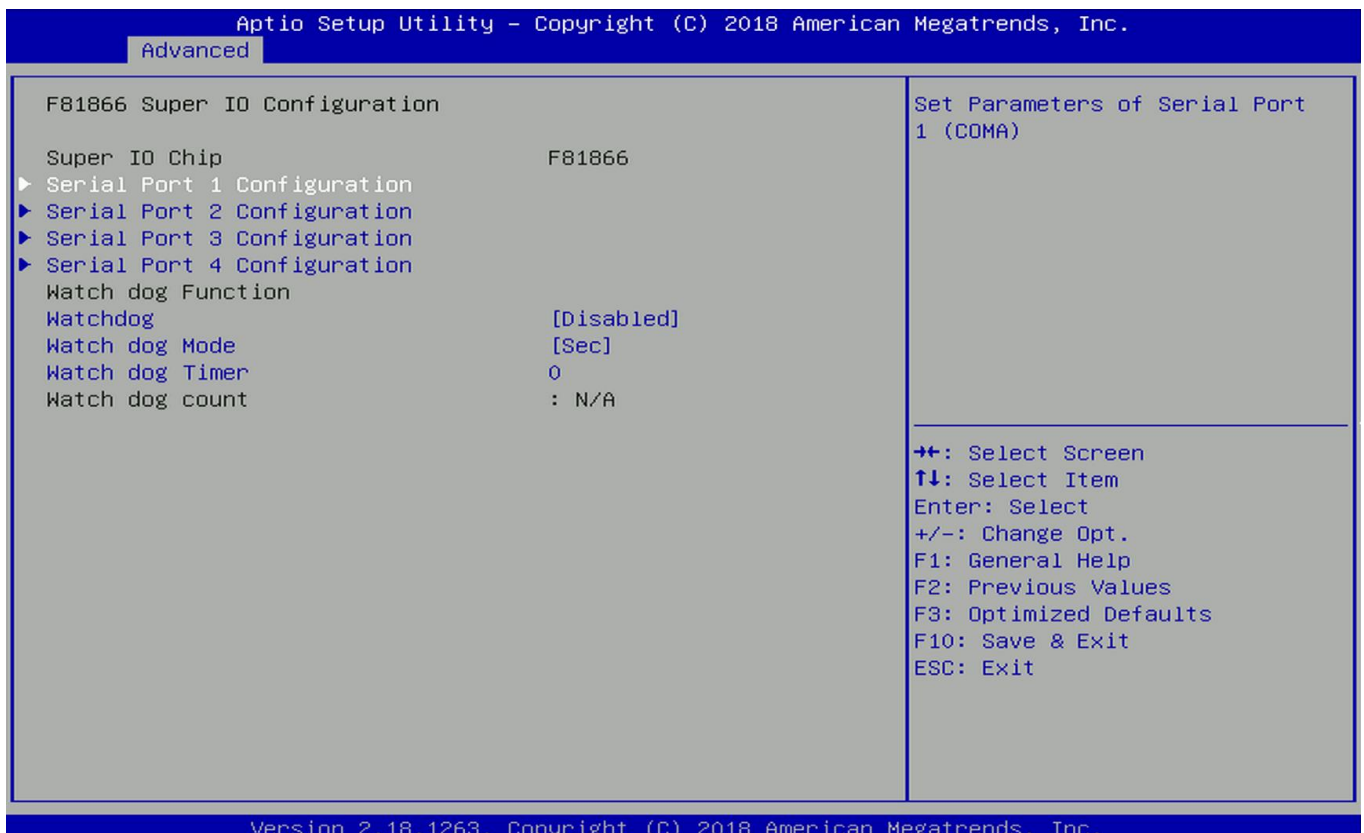

Serial Port 1~4 Configuration

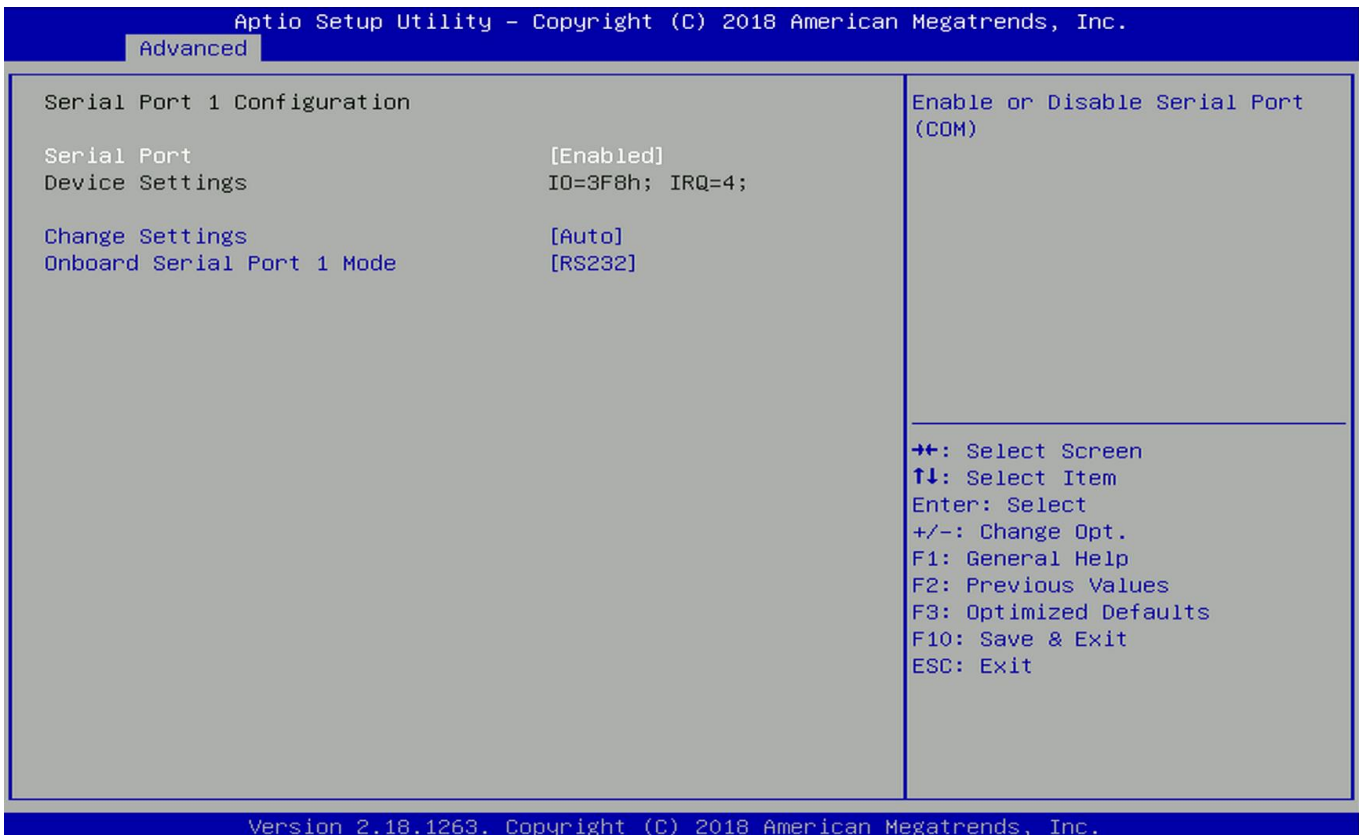

Serial Port [Enabled]

Enables or disables serial port.

Change Settings [Auto]

Allows you to change the IO Address & IRQ settings of the specified serial port.

Onboard Serial Port 1~4 Mode [RS232]

Allows you to select Serial Port Mode.

Configuration options: [RS232] [RS422/RS485 Full Duplex] [RS485 Half Duplex]

Watch Dog Function

You can setup the system watch-dog timer, a hardware timer that generates a reset when the software that it monitors does not respond as expected each time the watch dog polls it.

■ Watch Dog [Disabled]

Enables or disables watch dog function.

■ Watch Dog Mode [Sec]

Allows to set watchdog timer unit <Sec> or <Min>.

■ Watch Dog Timer [0]

Allows you to set watchdog timer's value in the range of 0 to 255.

4.3.3 Hardware Monitor

This screen displays the current status of all monitored hardware devices/components such as voltages, temperatures and all fans' speeds.

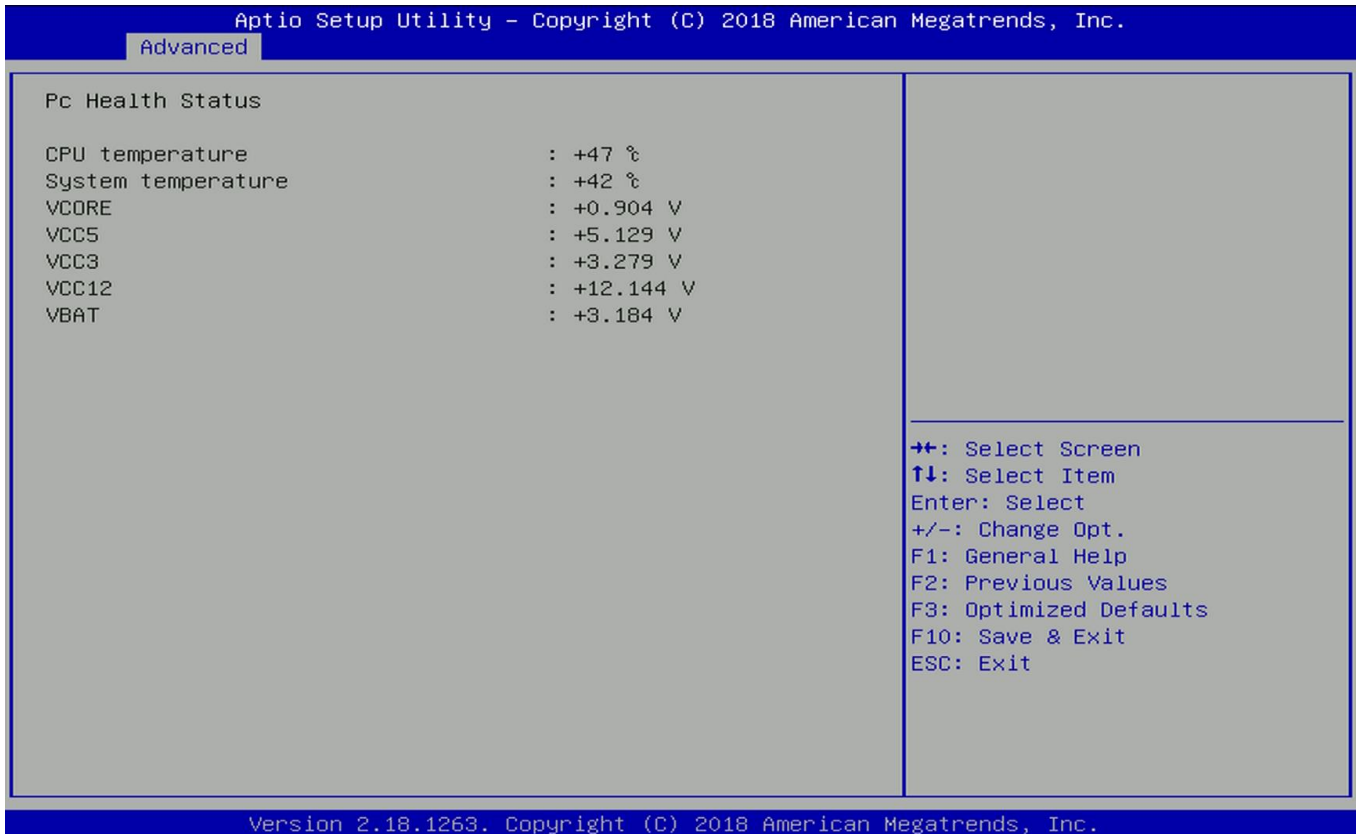

4.3.4 S5 RTC Wake Settings

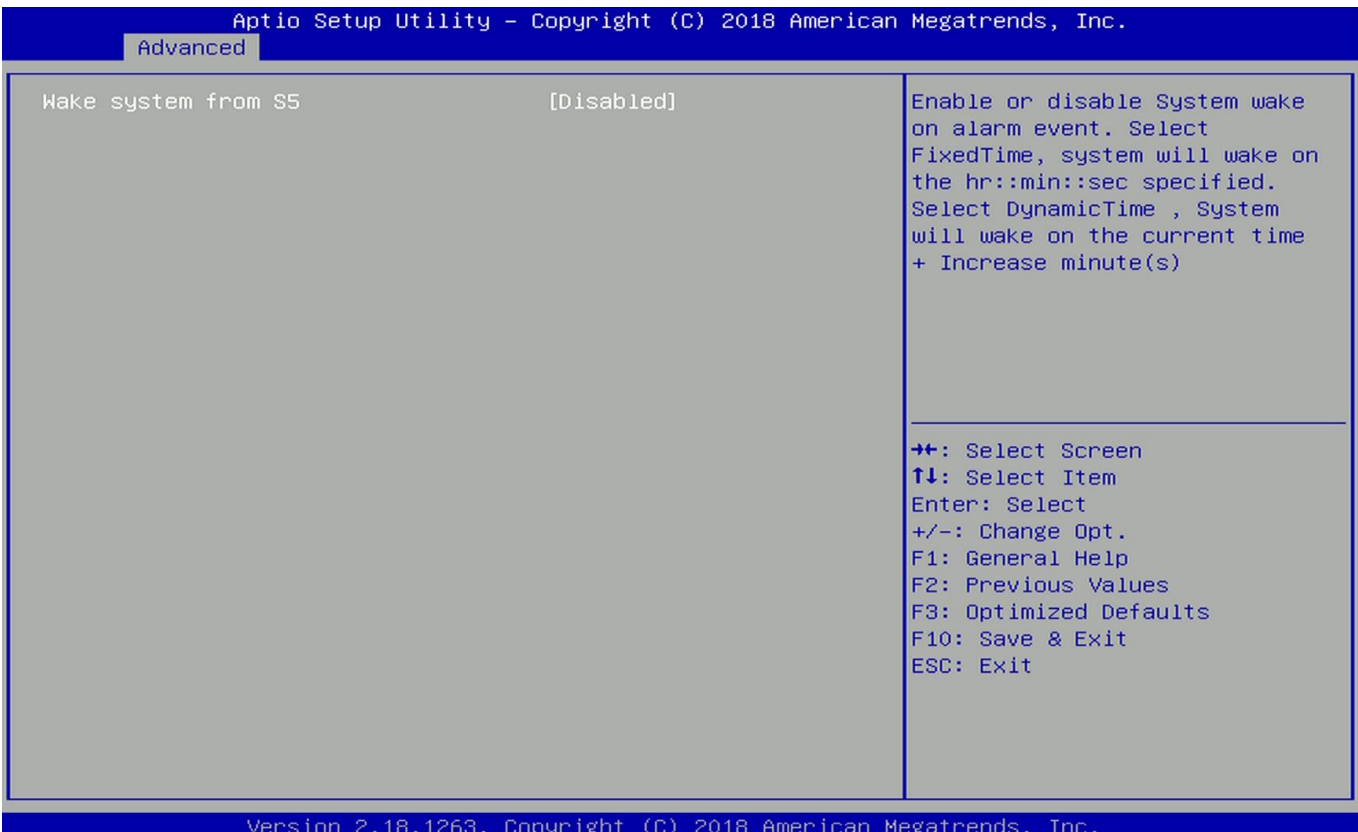

■ Wake system from S5 [Disabled]

Enables or disables wake system from S5 (soft-off state).

[Disabled]: Disables wake system from S5.

[Fixed Time]: Sets a fixed time (HH:MM:SS) to wake system from S5.

[Dynamic Time]: Sets a increase minute(s) from current time to wake system from S5.

4.3.5 Serial Port Console Redirection

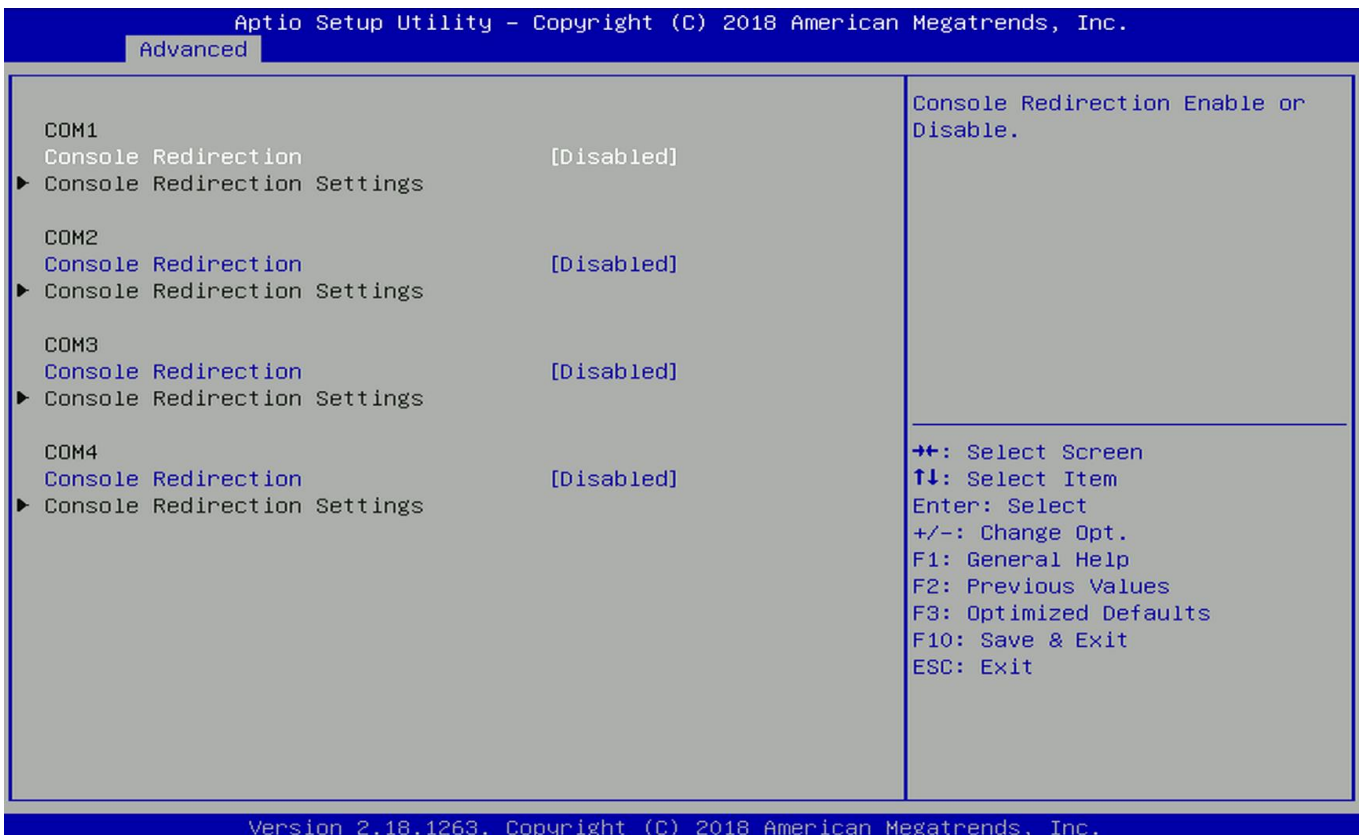

■ Console Redirection [Disabled]

Allow users to enable or disable COM1, COM2, COM3, COM4 console redirection function.

4.3.6 CPU Configuration

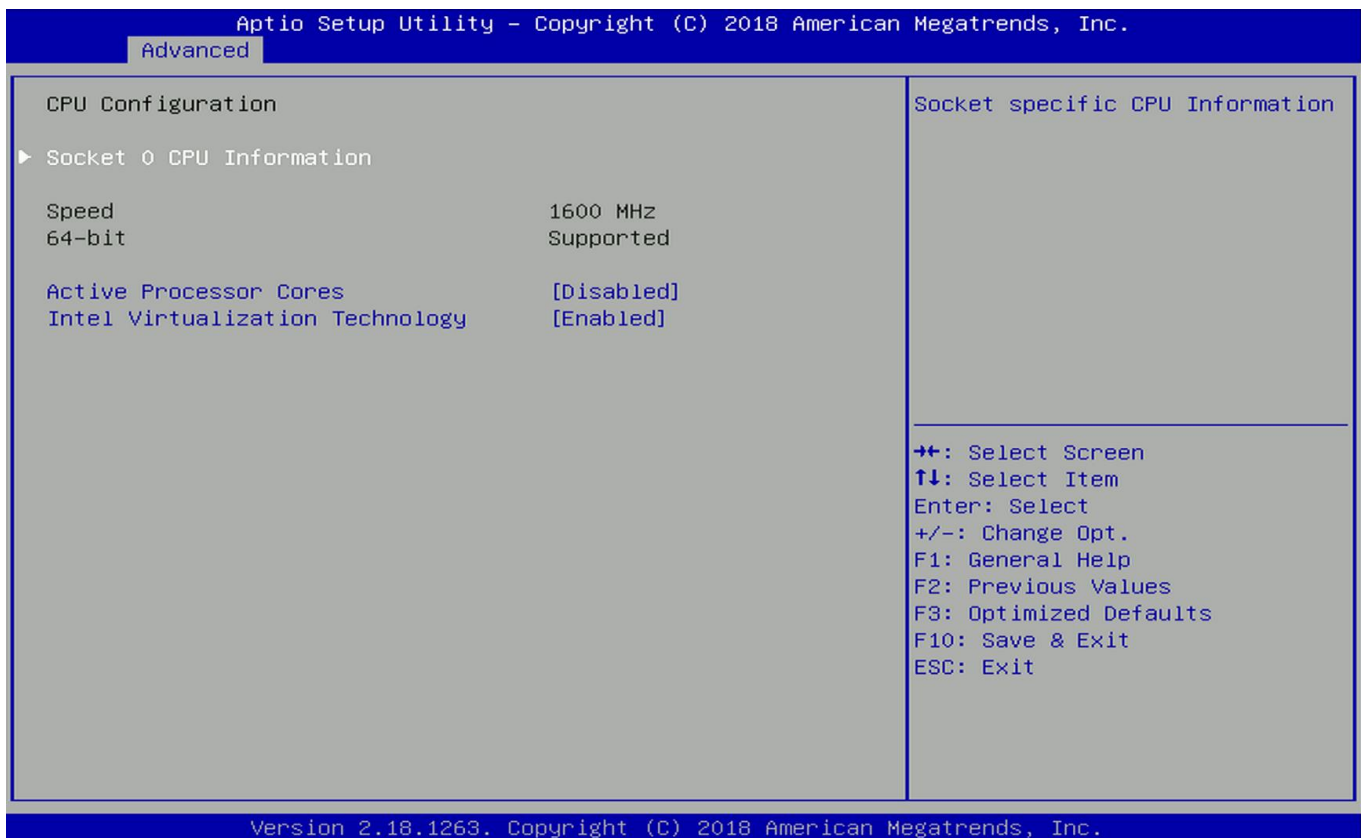

■ Socket 0 CPU Information

This section provides information on your CPU, frequency, and cache memory.

■ Active Processor Cores

Allows you to choose the number of active processor cores.

Configuration options: [All] [1].

■ Intel Virtualization Technology [Enabled]

Enables or disables Intel Virtualization Technology. Virtualization enhanced by Intel Virtualization Technology will allow a platform to run multiple operating systems and applications in independent partitions. With virtualization, one computer system can function as multiple virtual systems.

4.3.7 Network Stack Configuration

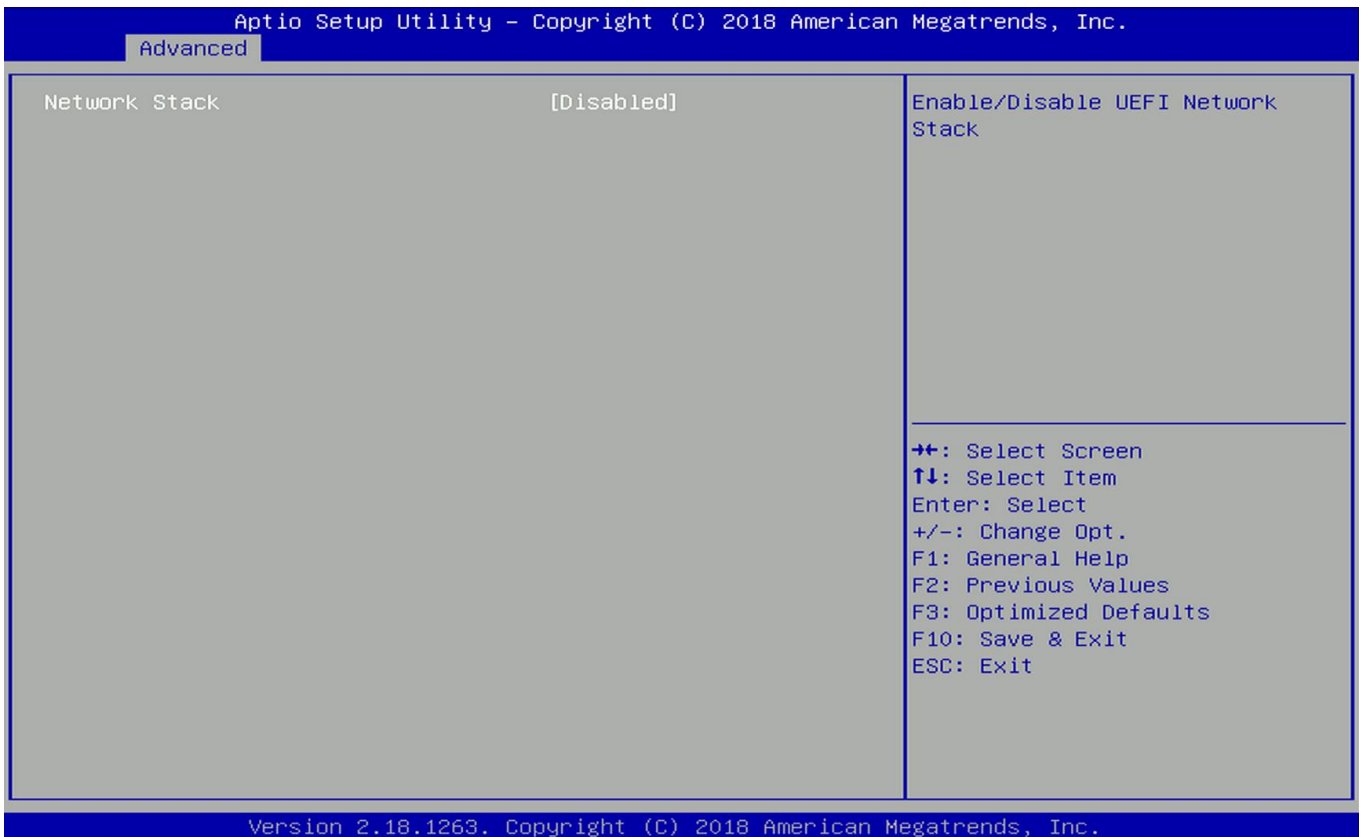

■ Network Stack [Disabled]

Enables or disables UEFI Network Stack.

4.3.8 CSM Configuration

This option controls legacy/UEFI ROMs priority.

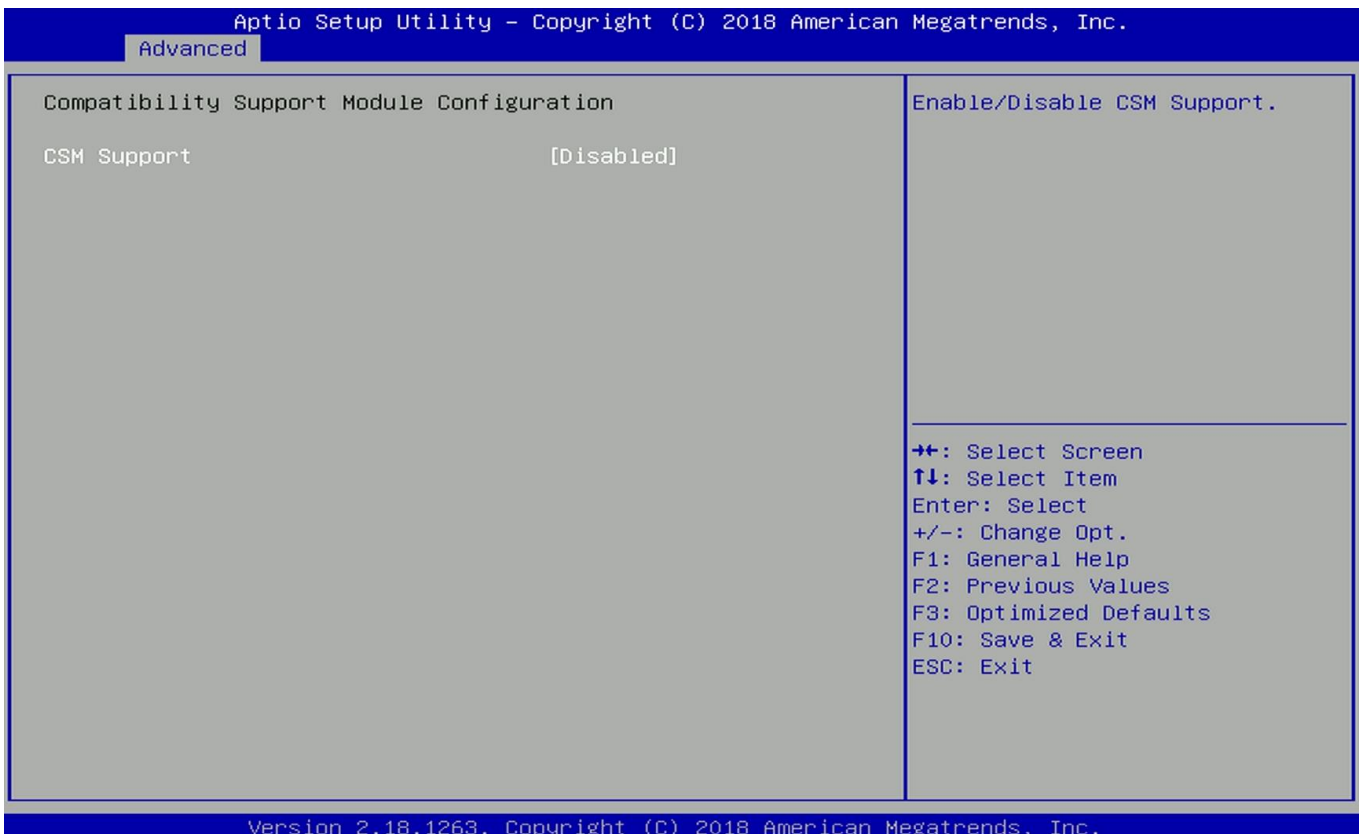

■ CSM Support [Disabled]

Enables or disables compatibility support module.

■ Boot option filter [UEFI and Legacy]

Allows you to select which type of operating system to boot.

[UEFI and Legacy]: Allows booting from operating systems that support legacy option ROM or UEFI option ROM.

[Legacy only]: Allows booting from operating systems that only support legacy option ROM.

[UEFI only]: Allows booting from operating systems that only support UEFI option ROM.

■ Network PXE [Do not launch]

Controls the execution of UEFI and Legacy PXE (Network Preboot eXecution Environment) option ROM.

[Do not launch]: Disables option ROM execution.

[UEFI]: Enables UEFI option ROM only.

[Legacy]: Enables legacy option ROM only.

■ Storage [UEFI]

Controls the execution of UEFI and Legacy Storage option ROM.

[Do not launch]: Disables option ROM execution.

[UEFI]: Enables UEFI option ROM only.

[Legacy]: Enables legacy option ROM only.

■ Video [UEFI]

Controls the execution of UEFI and Legacy Video option ROM.

[Do not launch]: Disables option ROM execution.

[UEFI]: Enables UEFI option ROM only.

[Legacy]: Enables legacy option ROM only.

■ Other PCI devices [Do not launch]

Allows users to determine option ROM execution policy for device other than network, storage, or video.

4.3.9 USB Configuration

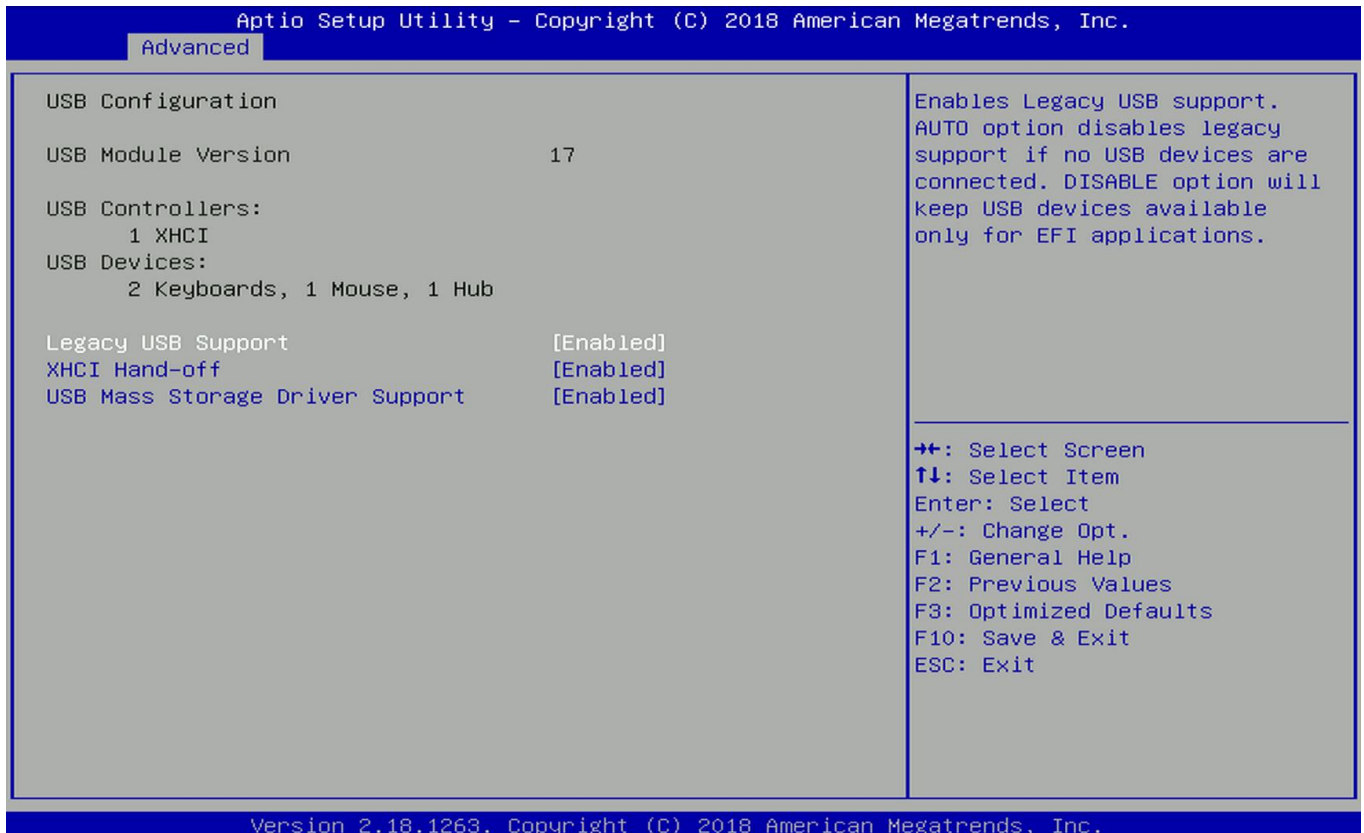

■ Legacy USB Support [Enabled]

This item allows you to enable or disable legacy USB support. When set to [Auto], legacy USB support will be disabled automatically if no USB devices are connected.

■ XHCI Hand-off [Enabled]

Enables or disables XHCI (USB3.0) hand-off function. Use this feature as a workaround for operating systems without XHCI hand-off support.

■ USB Mass Storage Driver Support [Enabled]

Enables or disables USB mass storage driver support.

4.4 Chipset Setup

This section allows you to configure chipset related settings according to user's preference.

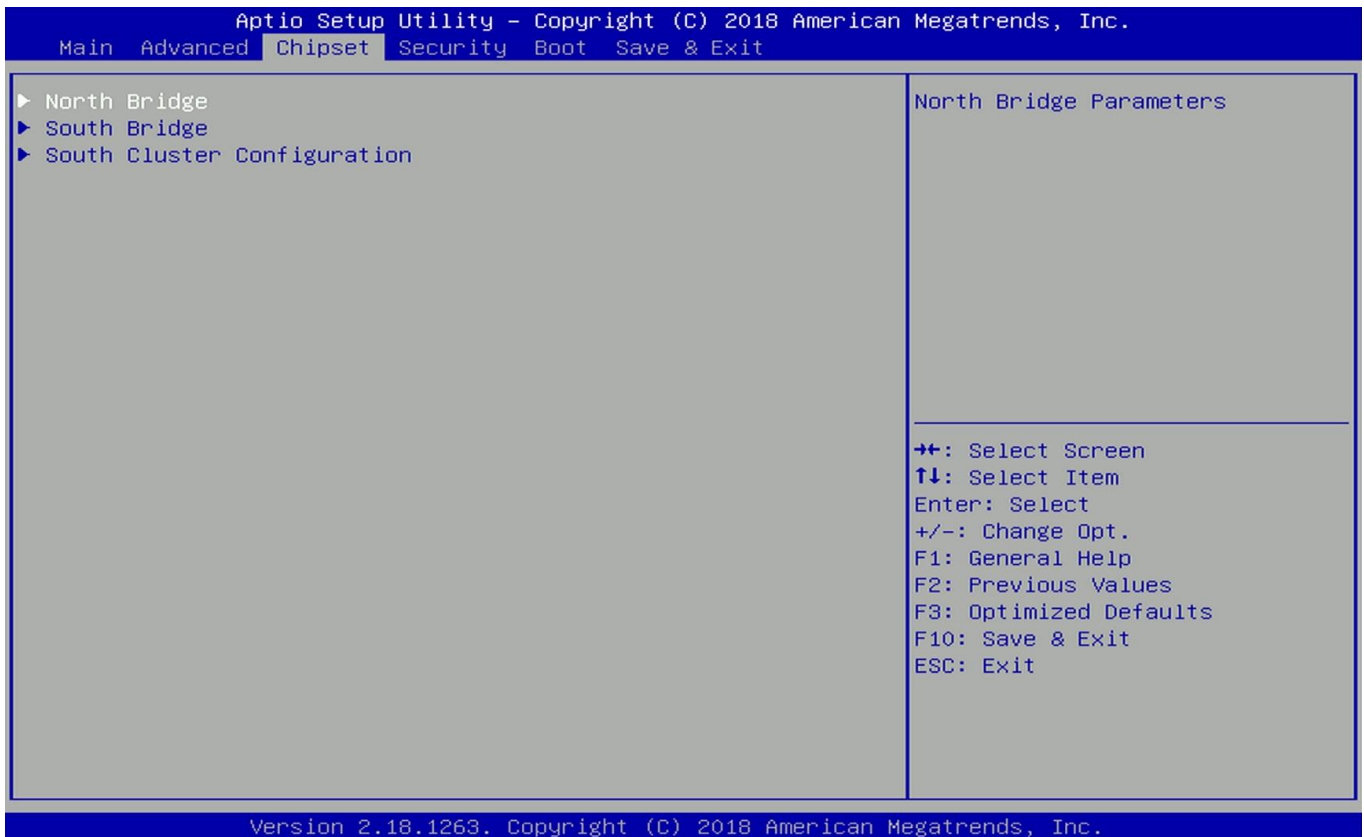

4.4.1 North Bridge

This section provides information on the installed memory size and memory/onboard graphics-related configuration options.

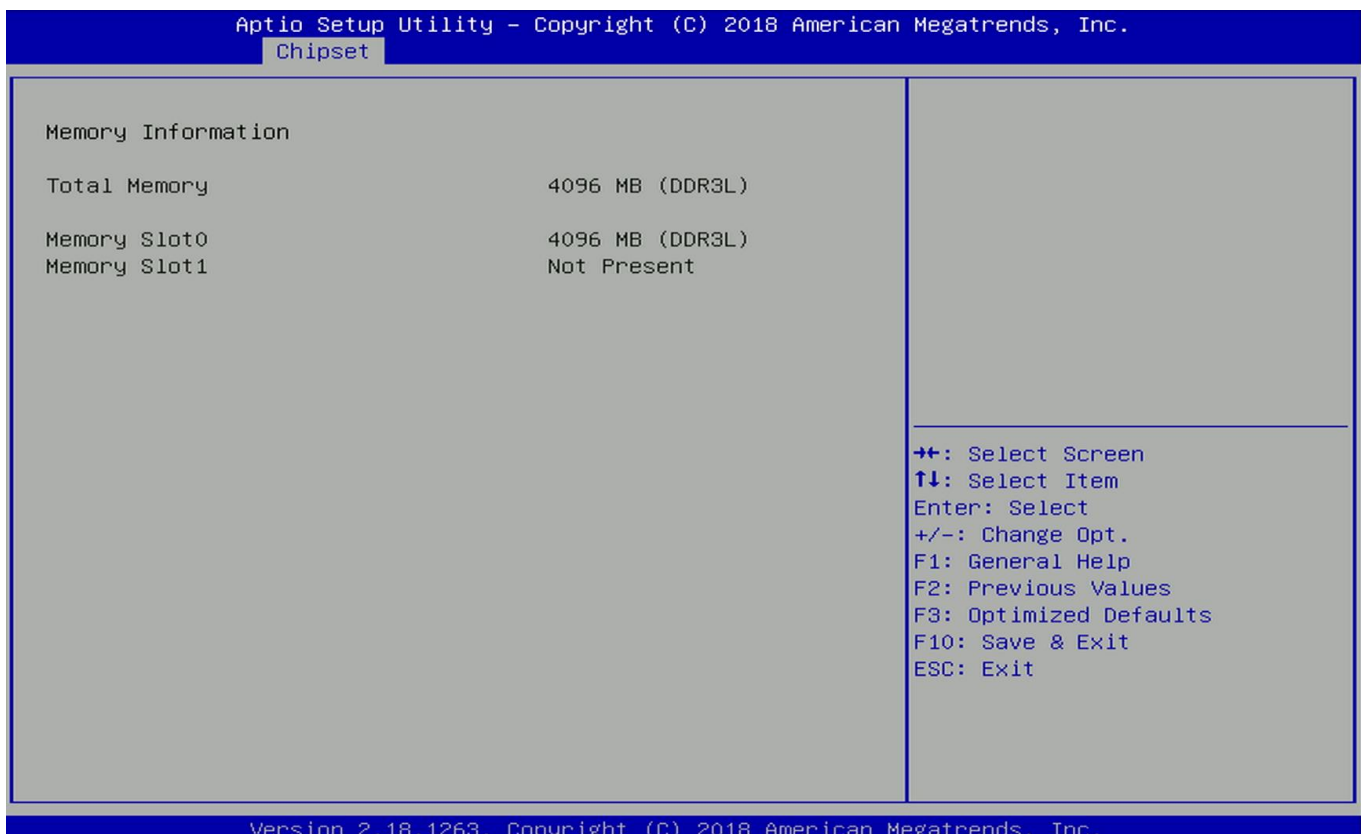

4.4.2 South Bridge

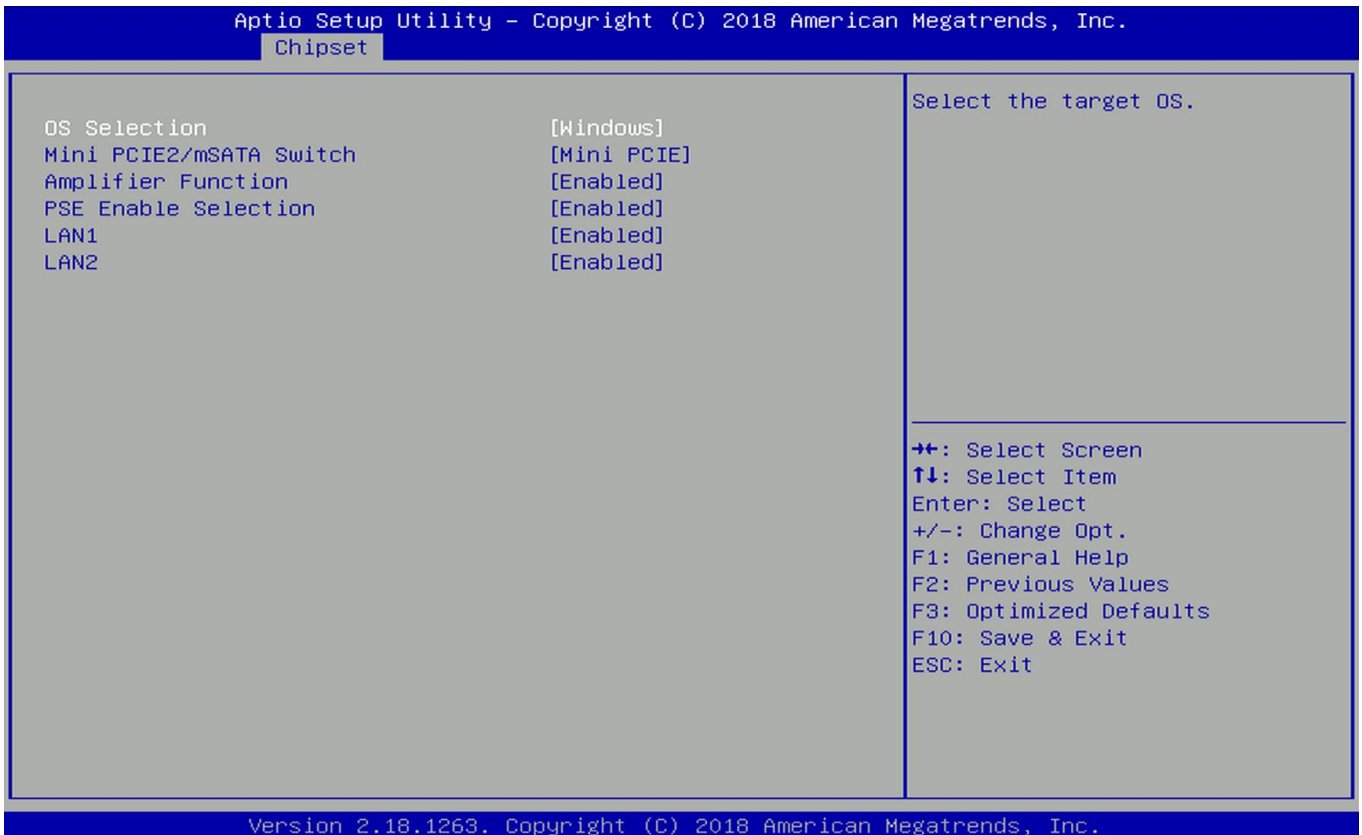

■ OS Selection [Windows]

Allows you to configure Operating System version to install.
Configuration options: [Windows] [Intel Linux]

■ Mini PCIE2/mSATA Switch [Mini PCIE]

Allows you to change **Mini PCIE2** as [Mini PCIE] or [mSATA].

■ Amplifier Function [Enabled]

Enables or disables Amplifier Function.

■ PSE Enable Selection [Enabled]

Enables or disables PSE (Power Sourcing Equipment).

■ LAN1 [Enabled]

Enables or disables LAN1 Controller.

■ LAN2 [Enabled]

Enables or disables LAN2 Controller.

4.4.3 South Cluster Configuration

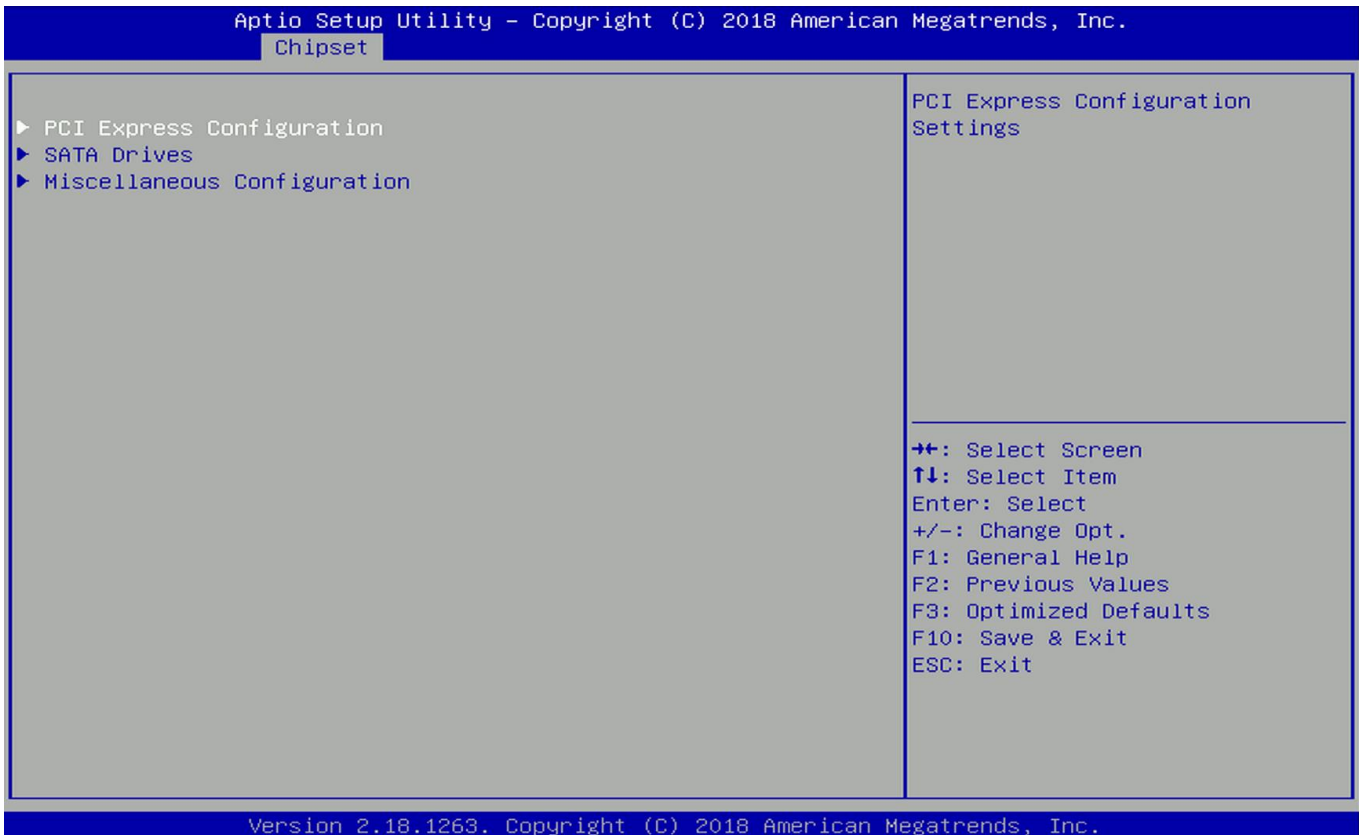

■ PCI Express Configuration

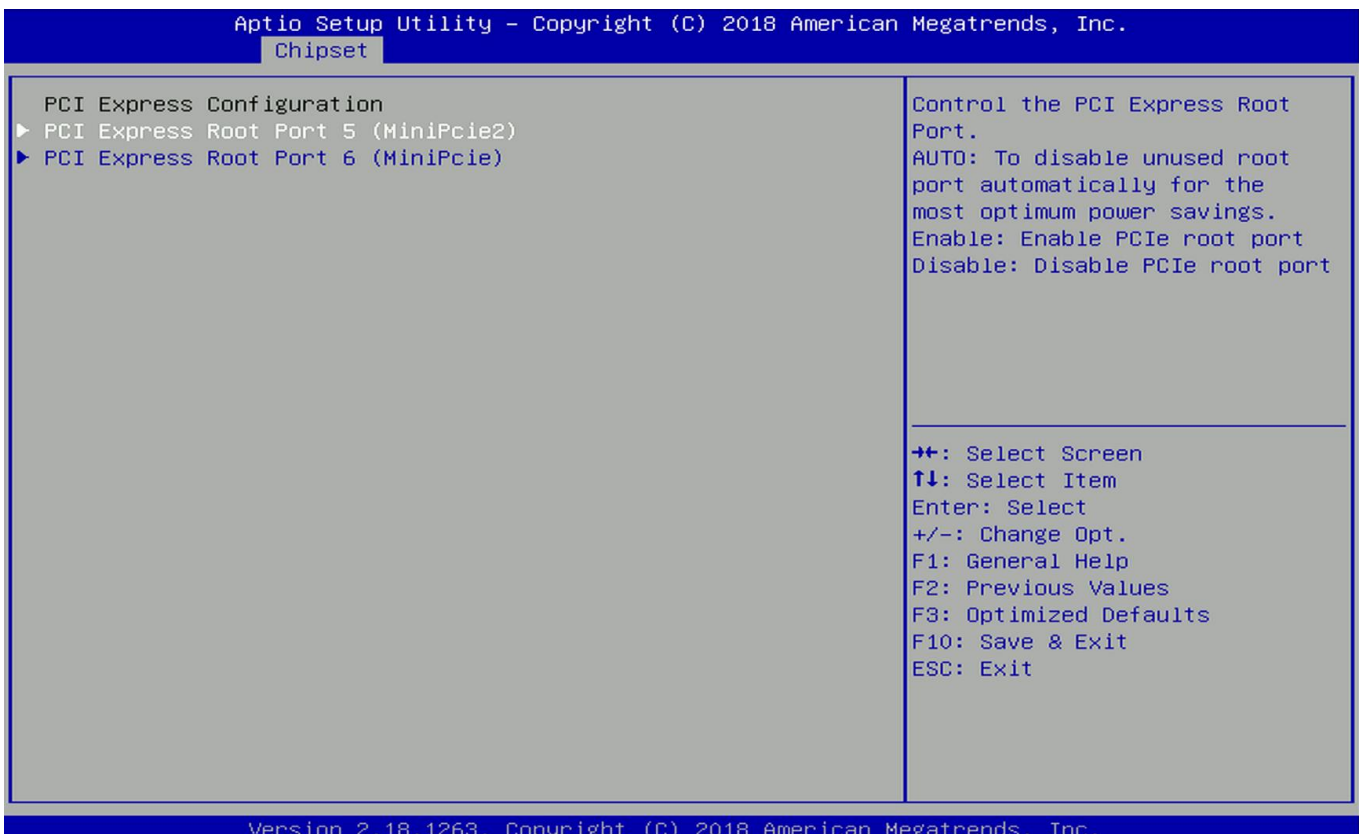

PCI Express Root Port 5 (MiniPcie2) **PCI Express Root Port 5 (MiniPcie2) [Enabled]**

Enables or disables PCI Express Root Port.

 PCleSpeed [Auto]

Allows you to select PCI Express port speed.

Configuration options: [Auto] [Gen1] [Gen2].

PCI Express Root Port 6 (MiniPcie) **PCI Express Root Port 6 (MiniPcie) [Enabled]**

Enables or disables PCI Express Root Port.

 PCleSpeed [Auto]

Allows you to select PCI Express port speed.

Configuration options: [Auto] [Gen1] [Gen2].

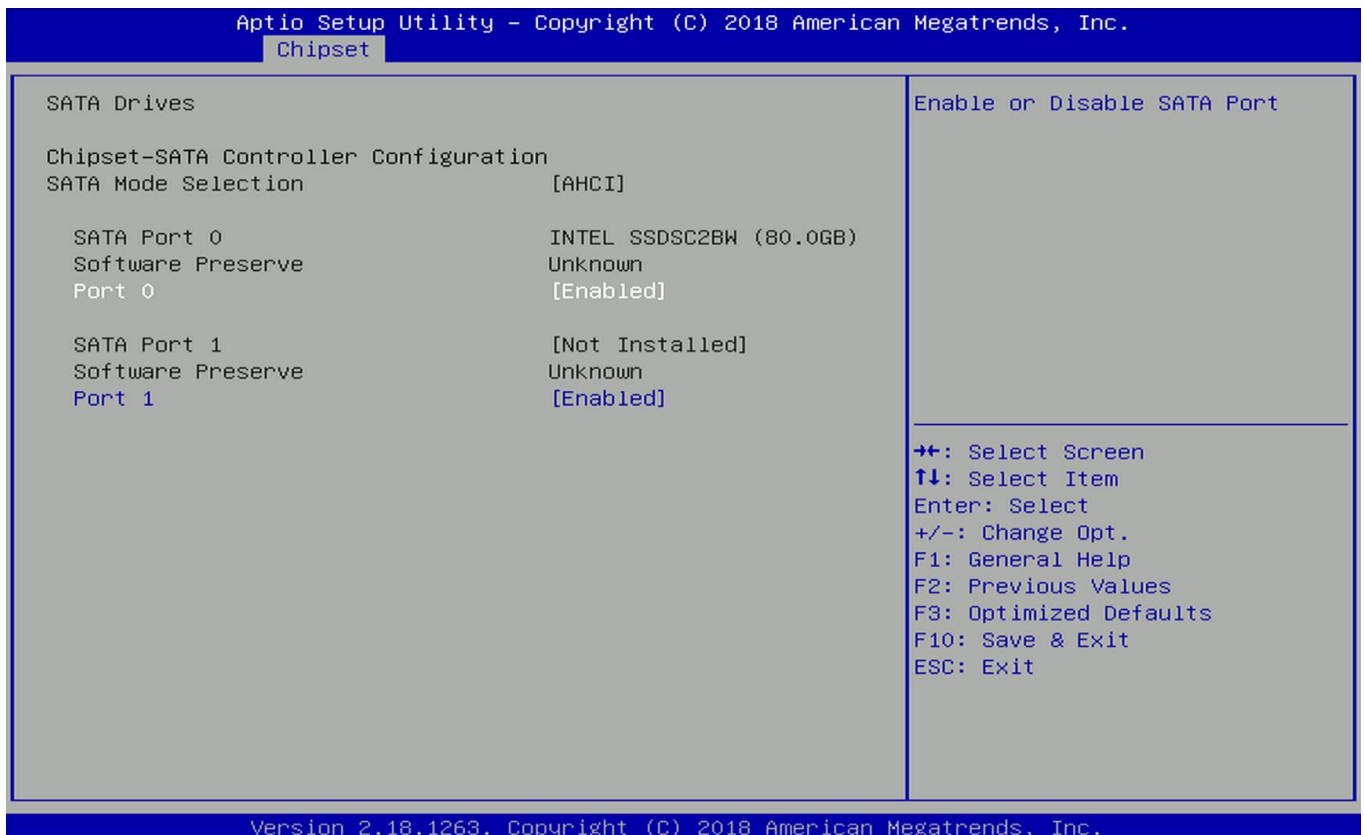
■ SATA Devices**SATA Port 0** **Port 0 [Enabled]**

Enables or disables SATA Port 0.

SATA Port 1 **Port 1 [Enabled]**

Enables or disables SATA Port 1.

■ Miscellaneous Configuration

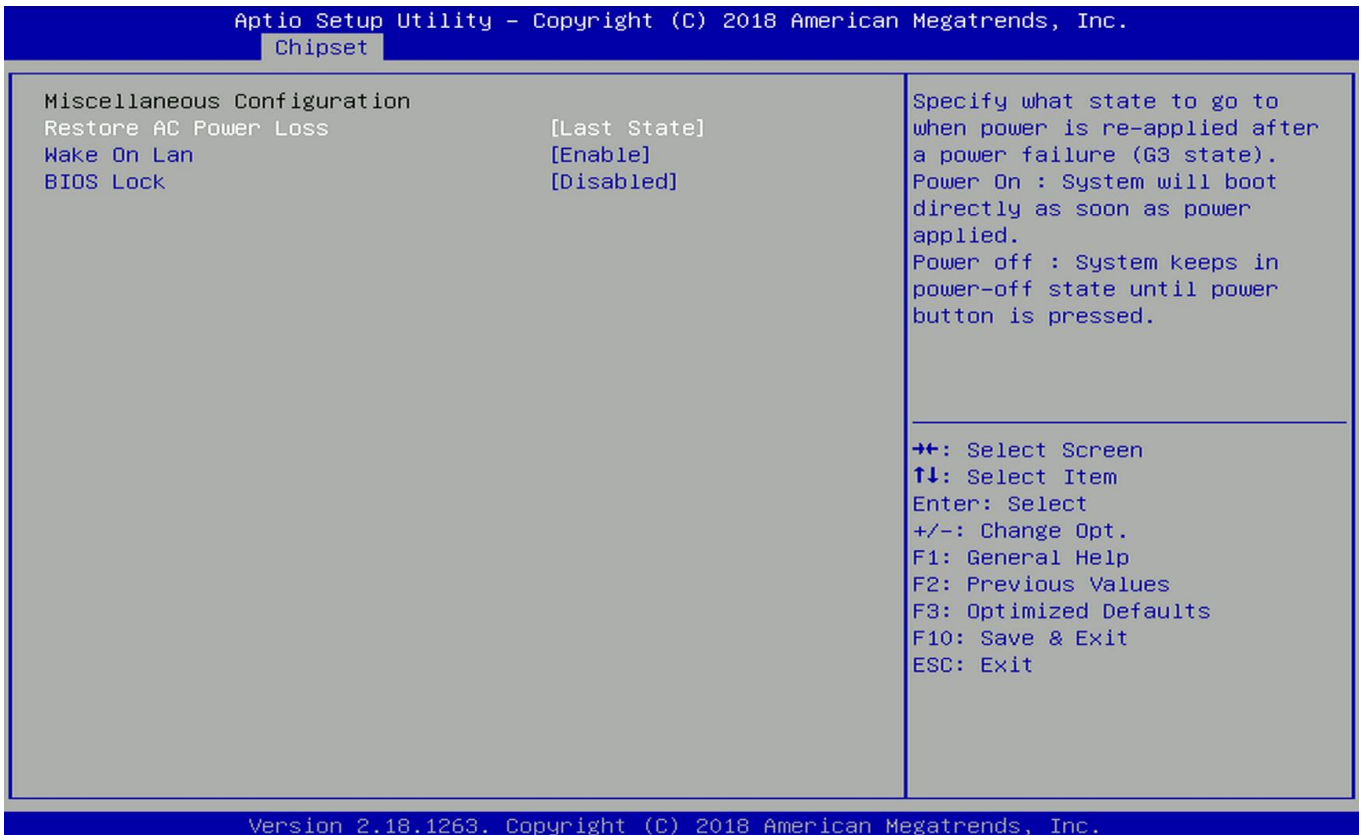

Restore AC Power Loss [Last state]

Allows you to specify which power state system will enter when power is resumed after a power failure (G3 state).

[Always on]: Enters to power on state.

[Always off]: Enters to power off state.

[Last state]: Enters to the last power state before a power failure cables.

Wake On Lan [Enabled]

Enables or disables Wake On LAN (WOL) function.

BIOS Lock [Disabled]

Enables or disables BIOS the SC BIOS Lock enable feature. It is required to be enabled to ensure SMM protection of flash.

4.5 Security Setup

This section allows you to configure BIOS security settings.

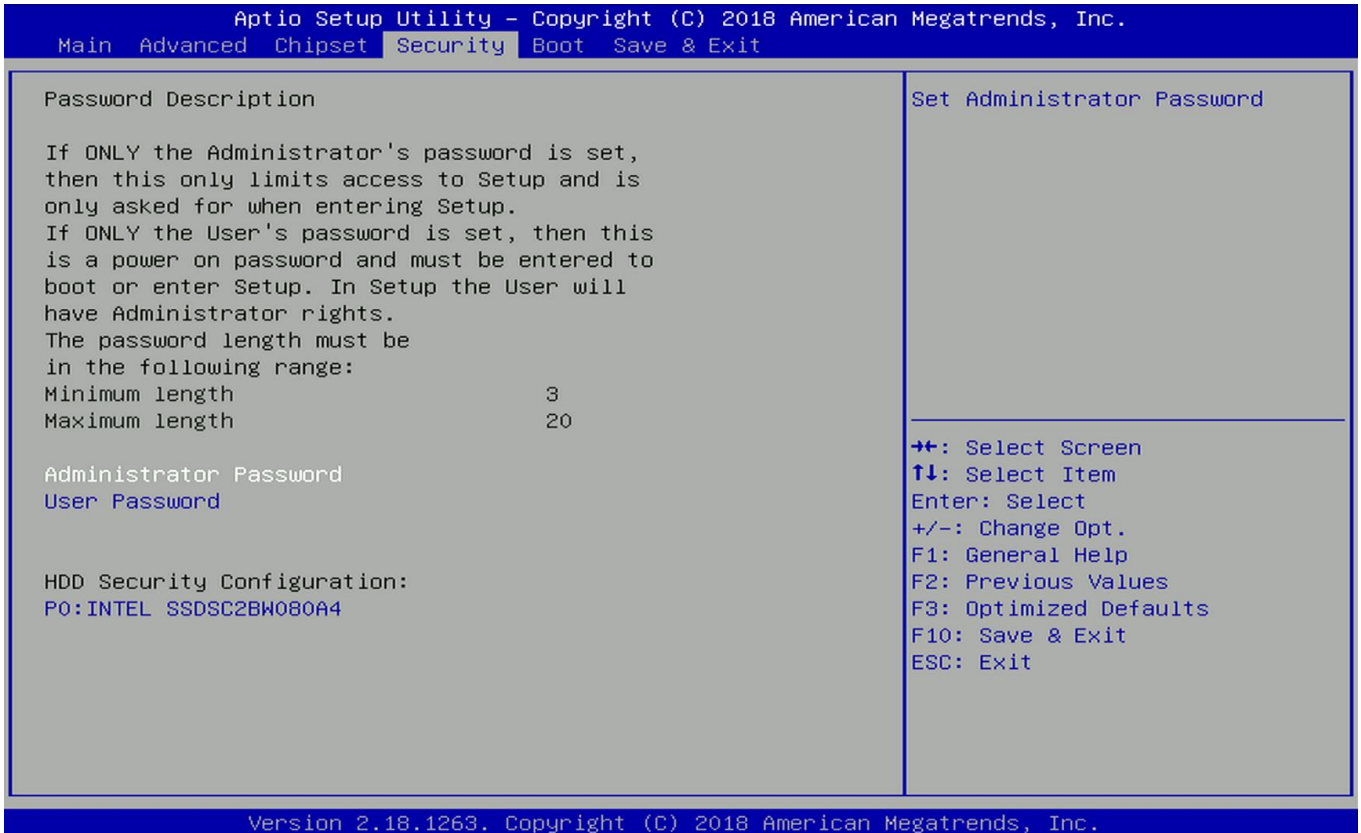

■ Administrator Password

Allows you to set Administrator Password to control access to the BIOS Setup utility.

■ User Password

Allows you to set User Password to control access to the system at boot and to the BIOS Setup utility.

4.6 Boot Setup

This section allows you to configure Boot settings.

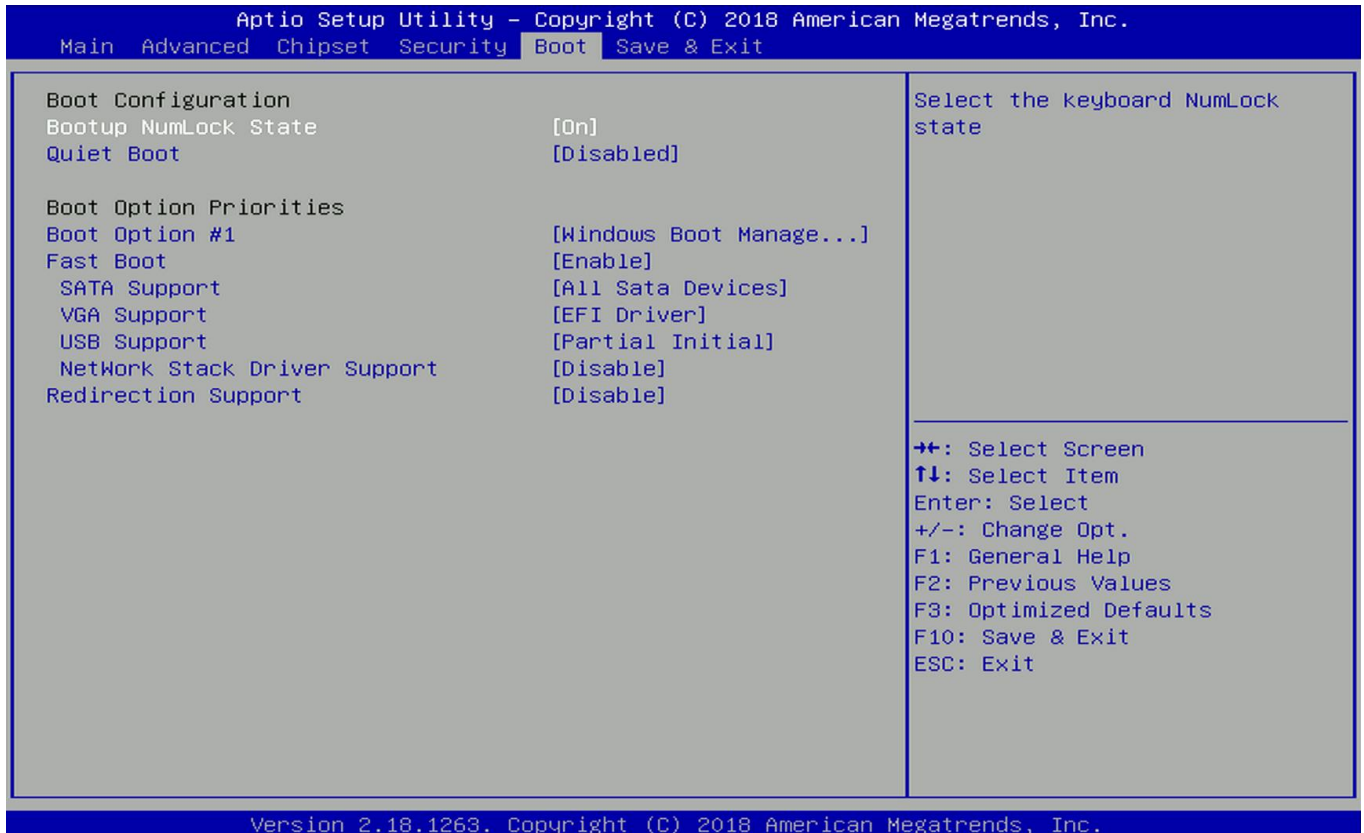

■ Bootup NumLock State

Allows you to set NumLock key to [On] or [Off] state when system boots up.

■ Quiet Boot

Allows you to enable or disable Quiet Boot function.

■ Fast Boot

Allows you to enable or disable Fast Boot function. If enabled, system boots with initialization of a minimal set of devices required to launch active boot option.

■ Hard Drive BBS Priority

Allows you to set the order of the legacy devices in this group.

4.7 Save & Exit

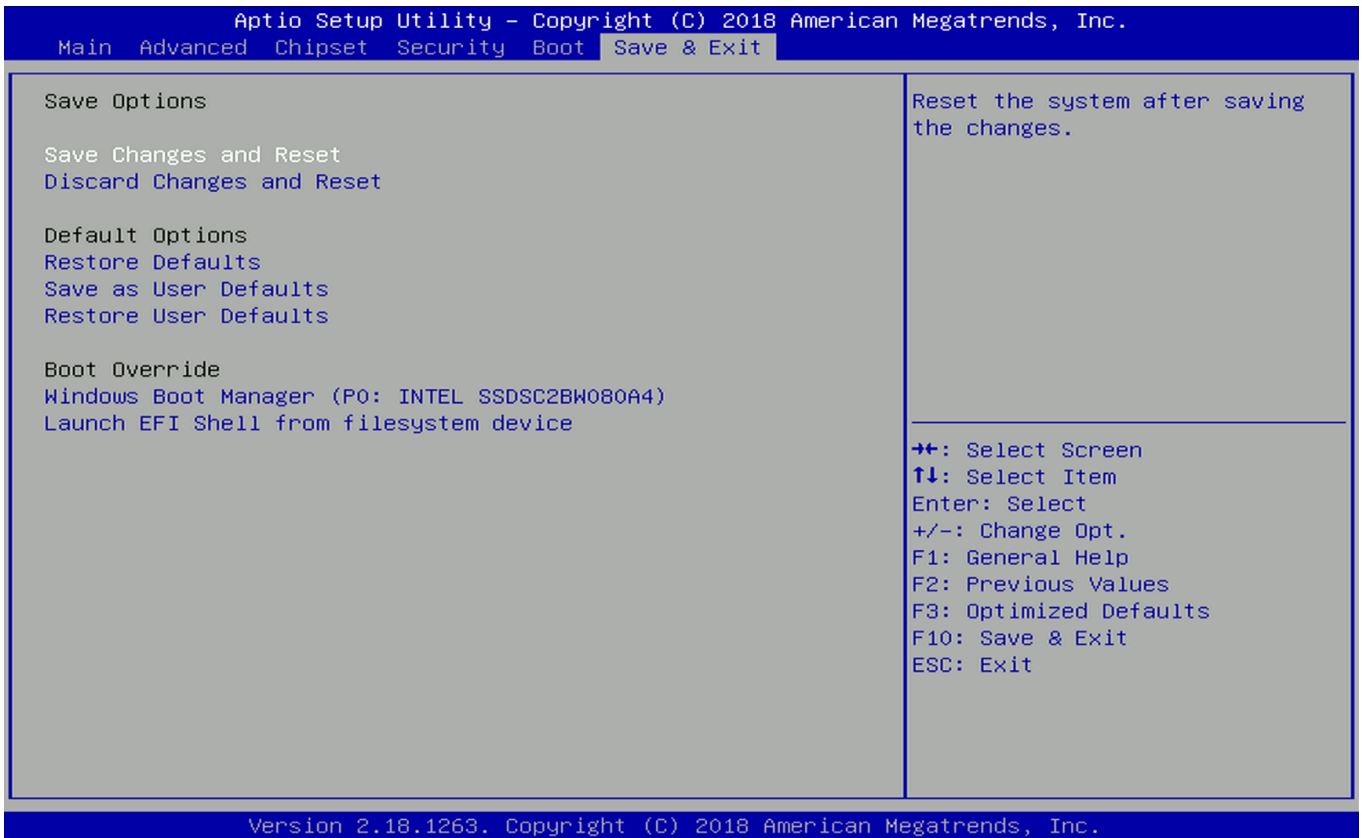

■ Save Changes and Reset

This item allows you to reset the system after saving changes.

■ Discard Changes and Reset

This item allows you to reset system setup without saving any changes.

■ Restore Defaults

This item allows you to restore/ load default values for all the setup options.

■ Save as User Defaults

This item allows you to save the changes done so far as user defaults.

■ Restore User Defaults

This item allows you to restore the user defaults to all the setup options.



Chapter 5

Product Application

5.1 Digital I/O (DIO) application

This section describes DIO application of the product. The content and application development are better understood and implemented by well experienced professionals or developers.

5.1.1 Digital I/O Programming Guide

5.1.1.1 Pins for Digital I/O for Cincoze P1100 series product

Item	Standard
GPIO74 (Pin107)	DI
GPIO75 (Pin108)	
GPIO76 (Pin109)	
GPIO77 (Pin110)	
GPIO80 (Pin111)	DO
GPIO81 (Pin112)	
GPIO82 (Pin113)	
GPIO83 (Pin114)	

5.1.1.2 Programming Guide

To program the Super I/O chip F81866A configuration registers, the following configuration procedures must be followed in sequence:

- (1) Enter the Extended Function Mode
- (2) Configure the configuration registers
- (3) Exit the Extended Function Mode

The configuration register is used to control the behavior of the corresponding devices. To configure the register, use the index port to select the index and then write data port to alter the parameters. The default index port and data port are 0x4E and 0x4F, respectively. **To enable configuration, the entry key 0x87 must be written to the index port. To disable configuration, write exit entry key 0xAA to the index port.** Following is an example to enable configuration and to disable configuration by using debug.

- o 4e 87
- o 4e 87 (enable configuration)
- o 4e aa (disable configuration)

5.1.1.3 Relative Registers

To program the F81866A configuration registers, see the following configuration procedures.

Logic Device Number Register (LDN) — Index 07h

Bit	Name	R/W	Reset	Default	Description
7-0	LDN	R/W	LRESET#	00h	00h: Select FDC device configuration registers. 03h: Select Parallel Port device configuration registers. 04h: Select Hardware Monitor device configuration registers. 05h: Select KBC device configuration registers. 06h: Select GPIO device configuration registers. 07h: Select WDT device configuration registers. 0Ah: Select PME, ACPI and ERP device configuration registers. 10h: Select UART1 device configuration registers. 11h: Select UART2 device configuration registers. 12h: Select UART3 device configuration registers. 13h: Select UART4 device configuration registers. 14h: Select UART5 device configuration registers. 15h: Select UART6 device configuration registers. Otherwise: Reserved.

7.7.11.1GPIO7 Output Enable Register — Index 80h

Bit	Name	R/W	Reset	Default	Description
7	GPIO77_OE	R/W	LRESET#	0	0: GPIO77 is in input mode. 1: GPIO77 is in output mode.
6	GPIO76_OE	R/W	LRESET#	0	0: GPIO76 is in input mode. 1: GPIO75 is in output mode.
5	GPIO75_OE	R/W	LRESET#	0	0: GPIO75 is in input mode. 1: GPIO75 is in output mode.
4	GPIO74_OE	R/W	LRESET#	0	0: GPIO74 is in input mode. 1: GPIO74 is in output mode.

7.7.11.3GPIO7 Pin Status Register — Index 82h (This byte could be also read by base address + 3)

Bit	Name	R/W	Reset	Default	Description
7	GPIO77_IN	R	-	-	The pin status of GPIO77/STB#.
6	GPIO76_IN	R	-	-	The pin status of GPIO76/AFD#.
5	GPIO75_IN	R	-	-	The pin status of GPIO75/ERR#.
4	GPIO74_IN	R	-	-	The pin status of GPIO74/INIT#.

7.7.12.1 GPIO8 Output Enable Register — Index 88h

3	GPIO83_OE	R/W	LRESET#	1	0: GPIO83 is in input mode. 1: GPIO83 is in output mode.
2	GPIO82_OE	R/W	LRESET#	1	0: GPIO82 is in input mode. 1: GPIO82 is in output mode.
1	GPIO81_OE	R/W	LRESET#	1	0: GPIO81 is in input mode. 1: GPIO81 is in output mode.
0	GPIO80_OE	R/W	LRESET#	1	0: GPIO80 is in input mode. 1: GPIO80 is in output mode.

7.7.12.2 GPIO8 Output Data Register — Index 89h (This byte could be also written by base address + 2)

3	GPIO83_VAL	R/W	LRESET#	1	0: GPIO83 outputs 0 when in output mode. 1: GPIO83 outputs 1 when in output mode.
2	GPIO82_VAL	R/W	LRESET#	1	0: GPIO82 outputs 0 when in output mode. 1: GPIO82 outputs 1 when in output mode.
1	GPIO81_VAL	R/W	LRESET#	1	0: GPIO81 outputs 0 when in output mode. 1: GPIO81 outputs 1 when in output mode.
0	GPIO80_VAL	R/W	LRESET#	1	0: GPIO80 outputs 0 when in output mode. 1: GPIO80 outputs 1 when in output mode.

5.1.1.4 Sample Code in C Language

5.1.1.4.1 Control of GP74 to GP77 (DI1 ~ DI4)

```
#define AddrPort 0x4E
#define DataPort 0x4F
```

<Enter the Extended Function Mode>

```
WriteByte(AddrPort, 0x87)
```

```
WriteByte(AddrPort, 0x87) // Must write twice to enter Extended mode
```

<Select Logic Device>

```
WriteByte(AddrPort, 0x07)
```

```
WriteByte(dataPort, 0x06) //Select logic device 06h
```

<Input Mode Selection> //Set GP74 to GP77 input Mode

```
WriteByte(AddrPort, 0x80) // Select configuration register 80h
```

```
WriteByte(DataPort, 0x0X) //Set (bit 4~7) = 0 to select GP 74~77 as Input mode
```

<input Value>

```
WriteByte(AddrPort, 0x82) // Select configuration register 82h
```

```
ReadByte(DataPort, Value) // Read bit 4~7(0xFx)= GP74 ~77 as High
```

<Leave the Extended Function Mode>

```
WriteByte(AddrPort, 0xAA)
```

5.1.1.4.2 Control of GP80 to GP83 (DO1 ~ DO4)

```
#define AddrPort 0x4E
#define DataPort 0x4F

<Enter the Extended Function Mode>
WriteByte(AddrPort, 0x87)
WriteByte(AddrPort, 0x87) // Must write twice to enter Extended mode

<Select Logic Device>
WriteByte(AddrPort, 0x07)
WriteByte(DataPort, 0x06) // Select logic device 06h

<Output Mode Selection> // Set GP80 to GP83 output Mode
WriteByte(AddrPort, 0x88) // Select configuration register 88h
WriteByte(DataPort, (0xFF)) //Set (bit 0~3) = 1 to select GP 80 ~83 as Output mode

<Output Value>
WriteByte(AddrPort, 0x89) // Select configuration register 89h
WriteByte(DataPort, Value) // Set bit 0~3=(0/1) to output GP 80~83 as Low or High

<Leave the Extended Function Mode>
WriteByte(AddrPort, 0xAA)
```

5.1.1.5 Change base address - DIO base address (Cincoze default 0xA00)

<Enter the Extended Function Mode>

WriteByte(AddrPort, 0x87)

WriteByte(AddrPort, 0x87) // Must write twice to enter Extended mode

<Select Logic Device>

WriteByte(AddrPort, 0x07)

WriteByte(dataPort, 0x06) // Select logic device 06h

WriteByte(AddrPort, 0x60) // Select configuration register 60h (High Byte address)

WriteByte(DataPort, (0x0A))

WriteByte(AddrPort, 0x61) // Select configuration register 61h (Low Byte address)

WriteByte(DataPort, (0x00))

<Leave the Extended Function Mode>

WriteByte(AddrPort, 0xAA)

Note: Cincoze DIO Port base address is 0x0A00h.

5.1.1.6 DATA Bit Table (DI/O)

7	6	5	4	3	2	1	0	bit
0	0	0	1	-	-	-	-	value
1			X				/h	

= DI1
(Base Address +3)
(0xA03)

7	6	5	4	3	2	1	0	bit
-	-	-	-	0	0	0	1	value
X				1			/h	

= DO1
(Base Address +2)
(0xA02)

7	6	5	4	3	2	1	0	bit
0	0	1	0	-	-	-	-	value
2			X				/h	

= DI2
(Base Address +3)
(0xA03)

7	6	5	4	3	2	1	0	bit
-	-	-	-	0	0	1	0	value
X				2			/h	

= DO2
(Base Address +2)
(0xA02)

7	6	5	4	3	2	1	0	bit
0	1	0	0	-	-	-	-	value
4			X				/h	

= DI3
(Base Address +3)
(0xA03)

7	6	5	4	3	2	1	0	bit
-	-	-	-	0	1	0	0	value
X				4			/h	

= DO3
(Base Address +2)
(0xA02)

7	6	5	4	3	2	1	0	bit
1	0	0	0	-	-	-	-	value
8			X				/h	

= DI4
(Base Address +3)
(0xA03)

7	6	5	4	3	2	1	0	bit
-	-	-	-	1	0	0	0	value
X				8			/h	

= DO4
(Base Address +2)
(0xA02)

5.1.1.7 DIO I/O Port Address

DI4	DI3	DI2	DI1	DO4	DO3	DO2	DO1	Pin Definition
7	6	5	4	3	2	1	0	Data Bits
DI				DO				DIO
0xA03				0xA02				I/O Port address

5.2 Digital I/O (DIO) Hardware Specification

- XCOM+ : Isolated power in V+
- XCOM- : Isolated power in V-
- Isolated power in DC voltage : 5 ~ 48V
- 4 x Digital Input (Source Type)
- Input Signal Voltage Level
 - Signal Logic 0 : XCOM+ = 5V, $\text{Signal Low} - V_- < 0.4V$
XCOM+ > 5V, $V_+ - \text{Signal Low} > 4.6V$
 - Signal Logic 1 : > $\text{XCOM+} - 3V$
- Input Driving Sink Current :
 - Minimal : 1 mA
 - Normal : 5 mA
- 4 x Digital Output (Open Drain)
 - DO Signal have to pull up resistor to XCOM+ for external device, the resistance will affect the pull up current
 - Signal High Level : Pull up resistor to XCOM+
 - Signal Low Level : = XCOM-
 - Sink Current: 1A (Max)

DIO1: Digital Input / Output Connector

Connector Type: Terminal Block 1X10 10-pin, 3.5mm pitch

Pin	Definition	Pin	Definition
1	XCOM+	6	DO1
2	DI1	7	DO2
3	DI2	8	DO3
4	DI3	9	DO4
5	DI4	10	XCOM-

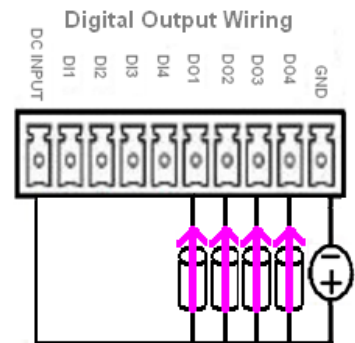
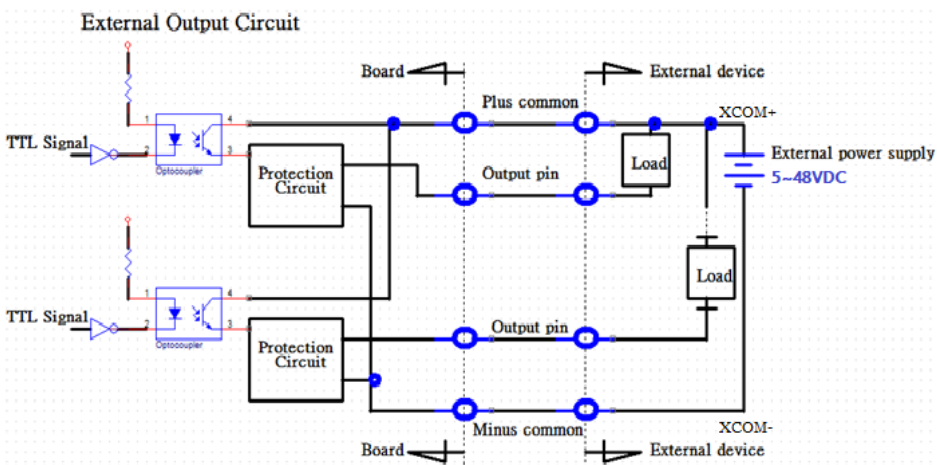
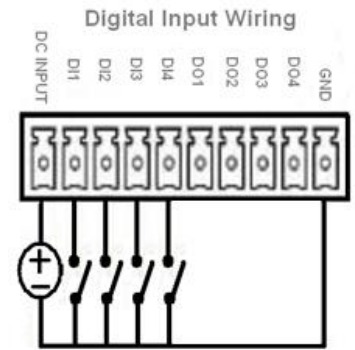
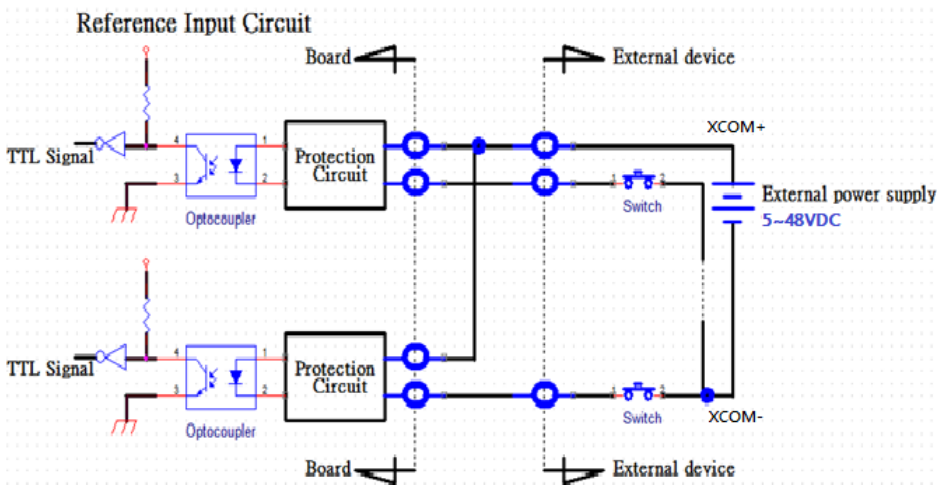
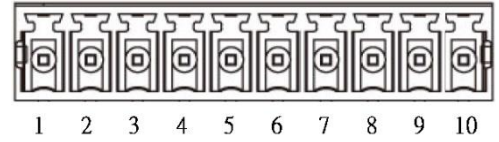



Chapter 6

Optional Module Pin Definitions and Settings

6.1 Location of the Connectors and Switches

Model No.	Description
CFM-IGN101	CFM Module with Power Ignition Sensing Control Function, 12V/24V Selectable
CFM-PoE02	CFM Module with PoE Control Function, Individual Port 25.5W

6.2 Installing a CFM-IGN Power Ignition Module

1. Locate the IGN connector on system motherboard as indicated.

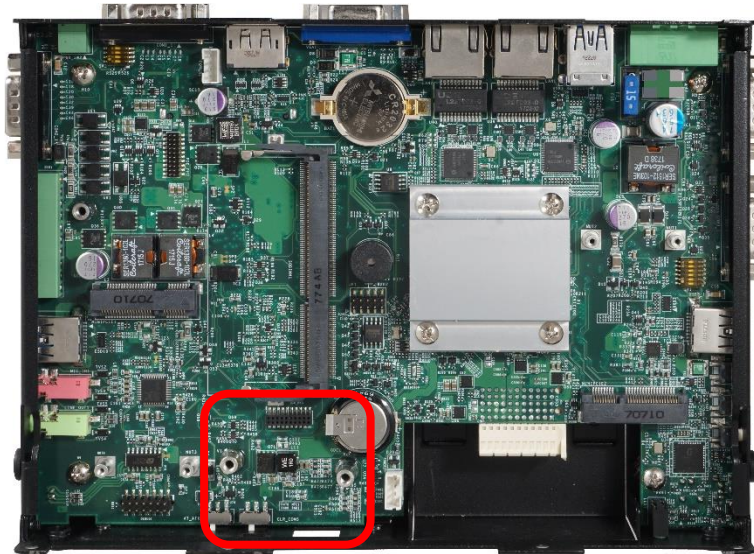

2. Insert CFM-IGN module vertically to the female connector on the system's mainboard, and fasten 2 screws to fix it.

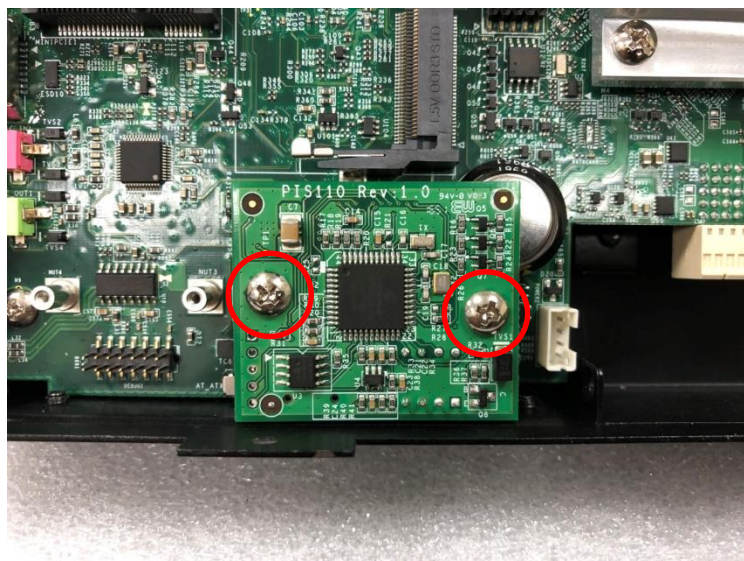

3. Loosen 2 screws on front panel to remove cover plate.



4. IGN function switch is at the front panel of the system.

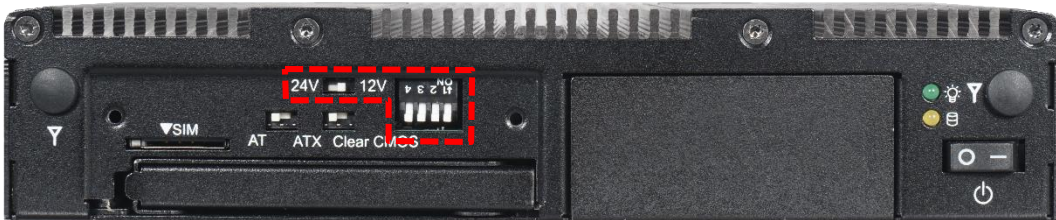

SW2: IGN Function Switch

Set shutdown delay timer when ACC is turned off

Pin 1	Pin 2	Pin 3	Pin 4	Definition
OFF / ON	ON	ON	ON	0 second
	ON	ON	OFF	1 minute
	ON	OFF	ON	5 minutes
	ON	OFF	OFF	10 minutes
	OFF	ON	ON	30 minutes
	OFF	ON	OFF	1 hour
	OFF	OFF	ON	2 hours
	OFF	OFF	OFF	Reserved (0 second)

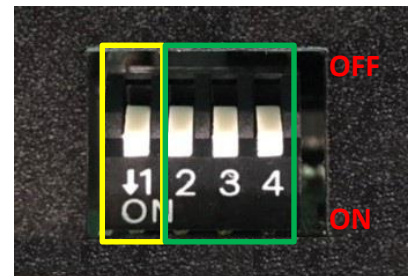

24V_12V_1: 12V / 24V Car Battery Switch

Pin	Definition
1-2	24V Car Battery Input
2-3	12V Car Battery Input



6.3 Installing a CFM-PoE Control Module

1. Locate the PoE connector on system motherboard as indicated.

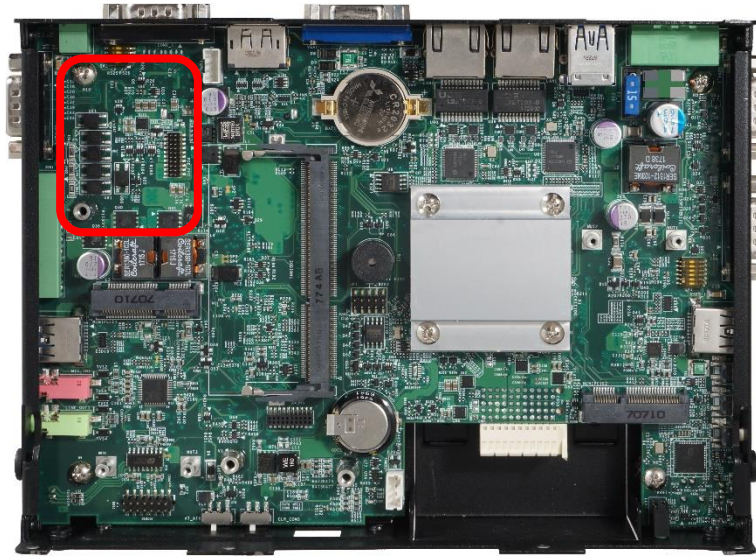

2. Insert the female connector of CFM-PoE module to the male connector on system motherboard.

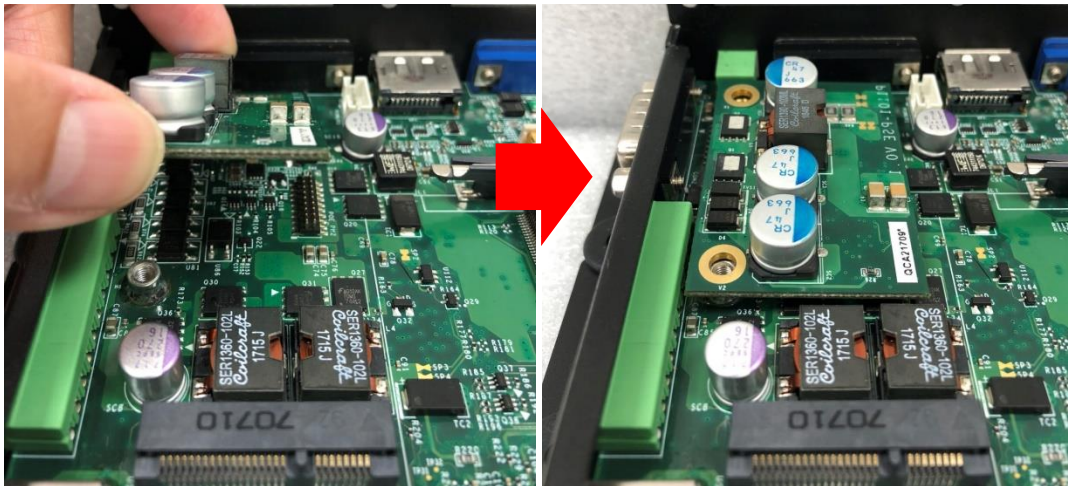

3. Turn over the heatsink and paste the thermal pad onto the marked by red squares.

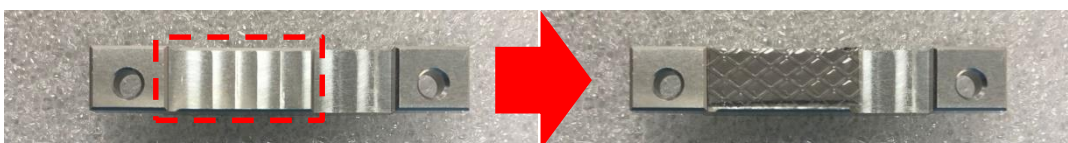

4. Paste the heatsink onto the CFM-PoE module carefully and fasten 2 screws to fix it.

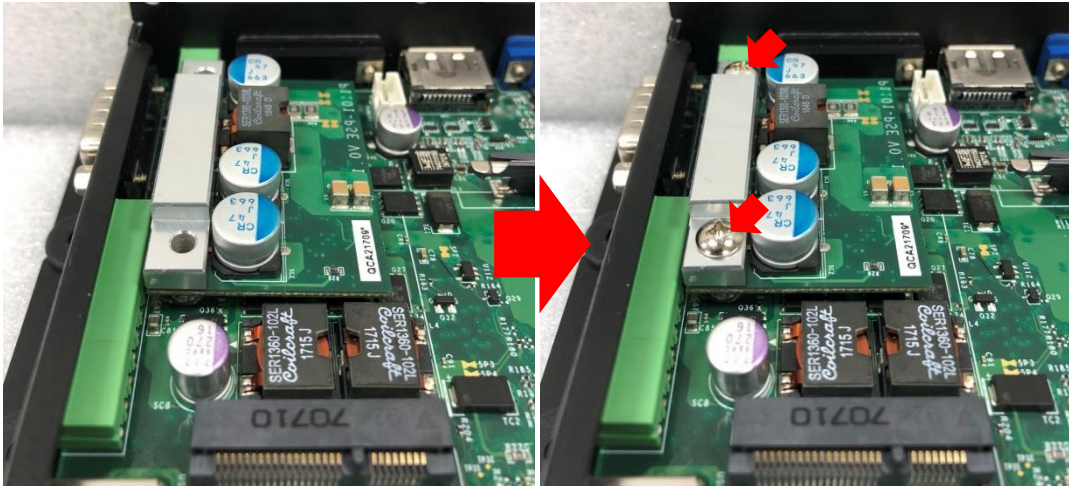

5. Paste the thermal pads onto the heatsink and coil carefully.

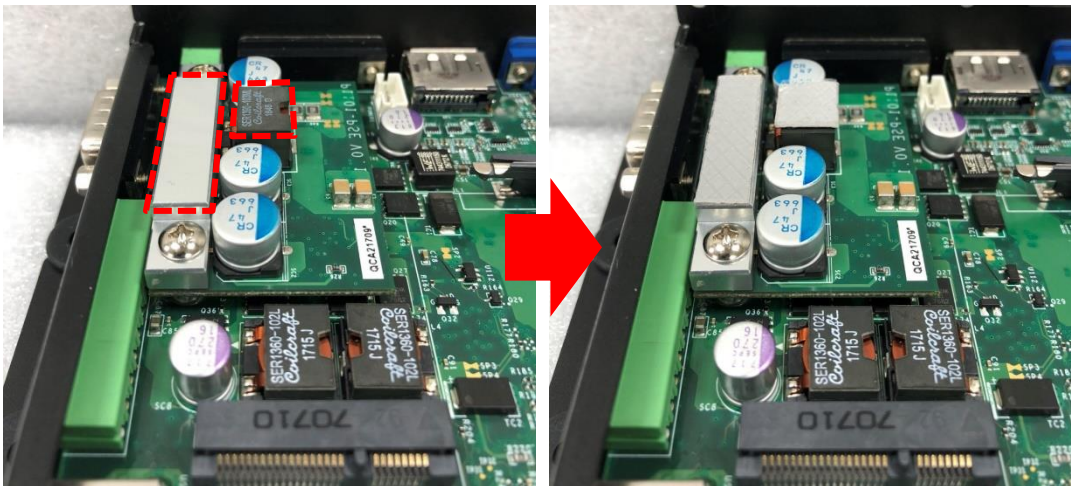



www.cincoze.com

© 2014 Cincoze Co., Ltd. All rights reserved.

The Cincoze logo is a registered trademark of Cincoze Co., Ltd.

All other logos appearing in this catalog are the intellectual property of the respective company, product, or organization associated with the logo.

All product specifications and information are subject to change without notice.