

**Korenix JetNet 6828Gf Series
Industrial 28G L3 Full Gigabit Managed Ethernet
Switch**

User Manual

Version 1.0

Aug., 2016

korenix

www.korenix.com

Korenix JetNet 6828Gf Series Industrial 28G L3 Full Gigabit Managed Ethernet Switch User's Manual

Copyright Notice

Copyright © 2006-2015 Korenix Technology Co., Ltd.

All rights reserved.

Reproduction in any form or by any means without permission is prohibited.

Federal Communications Commission (FCC) Statement

This equipment has been tested and found to comply with the limits for a Class A digital device, pursuant to Part 15 of the FCC Rules. These limits are designed to provide reasonable protection against harmful interference when the equipment is operated in a commercial environment. This equipment generates, uses, and can radiate radio frequency energy and, if not installed and used in accordance with the instruction manual, may cause harmful interference to radio communications. Operation of this equipment in a residential area is likely to cause harmful interference in which case the user will be required to correct the interference at his expense.

The user is cautioned that changes and modifications made to the equipment without approval of the manufacturer could void the user's authority to operate this equipment.

Index

1	Introduction.....	2
1.1	Overview.....	2
1.2	Major Features	3
1.3	Package List	4
2	Hardware Installation.....	5
2.1	Hardware Introduction	5
2.2	Wiring Power Inputs	7
2.3	Wiring Digital Output	8
2.4	Wiring Earth Ground	8
2.5	Wiring Fast Ethernet Ports	8
2.6	Wiring Fiber Ports.....	9
2.7	Wiring Gigabit Combo Ports	10
2.8	Wiring RS-232 Console Cable.....	10
2.9	Rack Mounting Installation.....	10
2.10	Safety Warning.....	12
3	Preparation for Management.....	13
3.1	Preparation for Serial Console	13
3.2	Preparation for Web Interface	14
3.3	Preparation for Telnet Console	16
4	Feature Configuration	19
4.1	Command Line Interface Introduction.....	20
4.2	Basic Setting	26
4.3	Port Configuration	51
4.4	Network Redundancy.....	61
4.5	VLAN	82
4.6	Private VLAN	92
4.7	Traffic Prioritization.....	99
4.8	Multicast Filtering.....	105
4.9	Routing.....	111
4.10	SNMP.....	135
4.11	Security	139
4.12	Warning.....	151
4.13	Monitor and Diagnostic	158
4.13	Device Front Panel.....	184
4.14	Save to Flash.....	185
4.15	Logout.....	186

5	Appendix.....	187
5.1	Korenix SFP family	187
5.2	Korenix Private MIB.....	189
5.3	Revision History	190
5.4	About Korenix	191

1 Introduction

Welcome to Korenix *JetNet 6828Gf* Industrial 28G L3 Full Gigabit Managed Ethernet Switch User Manual. Following topics are covered in this chapter:

1.1 Overview

1.2 Major Features

1.3 Package Checklist

1.1 Overview

The JetNet 6828Gf Series, the 19-inch Industrial 28G L3 Full Gigabit Managed Ethernet Switch includes JetNet 6828Gf-AC, JetNet 6828Gf-2AC, JetNet 6828Gf-AC-DC24, JetNet 6828Gf-2DC24 and JetNet 6828Gf-2DC48.

The JetNet 6828Gf Series is equipped with 24 100/1000TX, 8 100/1000 RJ-45/SFP combo ports, 4 GbE SFP ports. JetNet 6828Gf Series is a special design for control rooms where high-port density and performance are required. The 8 Gigabit Combo port design allows 100/1000 dual speed of copper ports, and the SFP ports accept all types of Gigabit SFP transceivers, including Gigabit SX, LX, LHX, ZX and XD for several connections and distances.

Model Name	Description
JetNet 6828Gf-AC	24 100/1000TX, 8 100/1000 RJ-45/SFP combo ports, 4 GbE SFP ports, Ind. L3 Full Gigabit Managed Ethernet Switch, -40~85°C, AC power
JetNet 6828Gf-2AC	24 100/1000TX, 8 100/1000 RJ-45/SFP combo ports, 4 GbE SFP ports, Ind. L3 Full Gigabit Managed Ethernet Switch, -40~85°C, dual AC power
JetNet 6828Gf-AC-DC24	24 100/1000TX, 8 100/1000 RJ-45/SFP combo ports, 4 GbE SFP ports, Ind. L3 Full Gigabit Managed Ethernet Switch, -40~85°C, AC and DC24V power
JetNet 6828Gf-2DC24	24 100/1000TX, 8 100/1000 RJ-45/SFP combo ports, 4 GbE SFP ports, Ind. L3 Full Gigabit Managed Ethernet Switch, -40~85°C, dual DC24V power
JetNet 6828Gf-2DC48	24 100/1000TX, 8 100/1000 RJ-45/SFP combo ports, 4 GbE SFP ports, Ind. L3 Full Gigabit Managed Ethernet Switch, -40~85°C, dual DC48V power

The device is mounted within the 19 inch rack, along with other 19 inch public servers or other network devices. When the lower industrial switches are aggregated to the JetNet

6828Gf, the 28G design allows connecting up to up to 14 rings. Each of the ring has its own ring redundancy protection. This is a unique and Korenix patent protected ring technology.

JetNet 6828Gf is designed as a fan-less rackmount switch with low power consumption and wide operating temperature. JetNet 6828Gf-AC-DC24/6828Gf-2DC24, the DC input model, allows 24V (18-36V) DC input. JetNet 6828Gf-2DC48, the DC input model, allows 24V (36-75VDC) DC input. JetNet 6828Gf supports Jumbo frame featuring up to 9,216 bytes packet size for large size file transmission. This is the trend for future industrial application requests.

The embedded software supports RSTP and Multiple Super Ring technology for ring redundancy protection. Full layer 2 management features include VLAN, IGMP Snooping, LACP for network control, SNMP, LLDP for network management. Secured access is protected by Port Security, 802.1x and flexible Layer 2/4 Access Control List. With JetNet 6828Gf, you can fulfill the technicians' need of having best solution for the industrial Ethernet infrastructure.

1.2 Major Features

Korenix JetNet 6828Gf has the following major features:

- 24 100/1000Base-TX, 8 100/1000 RJ-45/SFP combo ports, 4 Gigabit SFP ports
- Non-Blocking Switching Performance, no collision or delay when wire-speed transmission
- Supports Jumbo Frame up to 9,216 byte
- RSTP and Multiple Super Ring (Rapid Super Ring, Rapid Dual Homing, MultiRing, TrunkRing)
- Maximum 14 Gigabit Rings aggregation capability
- VLAN, LACP, GVRP, QoS, IGMP Snooping, Rate Control, Online Multi Port Mirroring
- Link Layer Discovery Protocol (LLDP), SNMP V1/V2c/V3, RMON and KorenixView Discovering and Management
- Advanced Security supports IP/Port Security, 802.1x and Access Control List
- Event Notification by E-mail, SNMP Trap, Syslog and Relay Output
- Rigid Aluminum Case complies with IP31
- 90-264VAC, Dual 18-36VDC or Dual 36-75VDC power input

Note: The detail spec is listed in latest datasheet. Please download the latest datasheet in Korenix Web site.

1.3 Package List

Korenix JetNet 6828Gf Series products are shipped with following items:

JetNet 6828Gf-AC/6828Gf-2AC/6828Gf-AC-DC24 Industrial 28G L3 Full Gigabit Managed Ethernet Switch

JetNet 6828Gf (no SFP transceivers)

Rack Mount Kit

Console Cable

Power Cord

QIG

JetNet 6828Gf-2DC24/JetNet 6828Gf-2DC48 Industrial 28G L3 Full Gigabit Managed Ethernet Switch with 18-36VDC or 36-75VDC input

JetNet 6828Gf (no SFP transceivers)

Rack Mount Kit

Console Cable

QIG

If any of the above items are missing or damaged, please contact your local sales representative.

2 Hardware Installation

This chapter includes hardware introduction, installation and configuration information.

Following topics are covered in this chapter:

2.1 Hardware Introduction

Dimension

Panel Layout

Bottom View

2.2 Wiring Power Inputs

2.3 Wiring Digital Output

2.4 Wiring Earth Ground

2.5 Wiring Ethernet Ports

2.6 Wiring Fiber Ports

2.7 Wiring Gigabit Combo Ports

2.8 Wiring RS-232 console cable

2.9 Rack Mounting Installation

2.10 Safety Warning

2.1 Hardware Introduction

LED

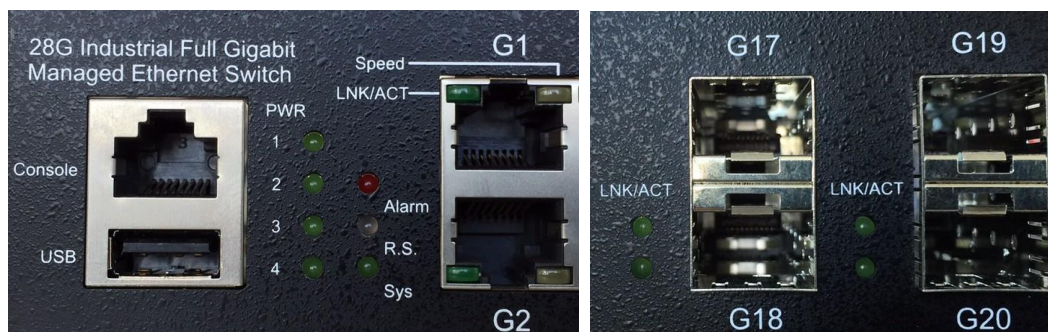

R.S MSR status LED:

1. MSR in Normal State (Lit Green)
2. MSR in Abnormal State (Lit Yellow)
3. MSR function not active (Not Lit)
4. Incorrect configuration of MSR, ex. ring not connected to ring port (Flashes Green)
5. The break has been detected to be local to one of the ports (Flashes Yellow)

G1-G24 copper port LED:

10/100/1000 RJ-45: Link/Activity (Lit Green/Flashes Green)

Speed (Yellow on:1000Mbps , Yellow off:10/100Mbps

G17-G28 SFP LED:

Link/Activity (Lit Green/Flashes Green)

Diagnostic LED:

AC/DC Power (Green), Sys (Green), Alarm (Red)

Relay Alarm: 1 set of relay output with current carrying capability of 1A@24V

Alarm Events: Power (AC1, AC2, DC1, DC2) failure, port failure, ping failure, login failure,

RSR topology change

Dimension

JetNet 6828Gf Industrial 28G L3 Full Gigabit Managed Ethernet Switch dimension (W x H x D) is 44mm(H) x 440mm (W) x 378mm (D)

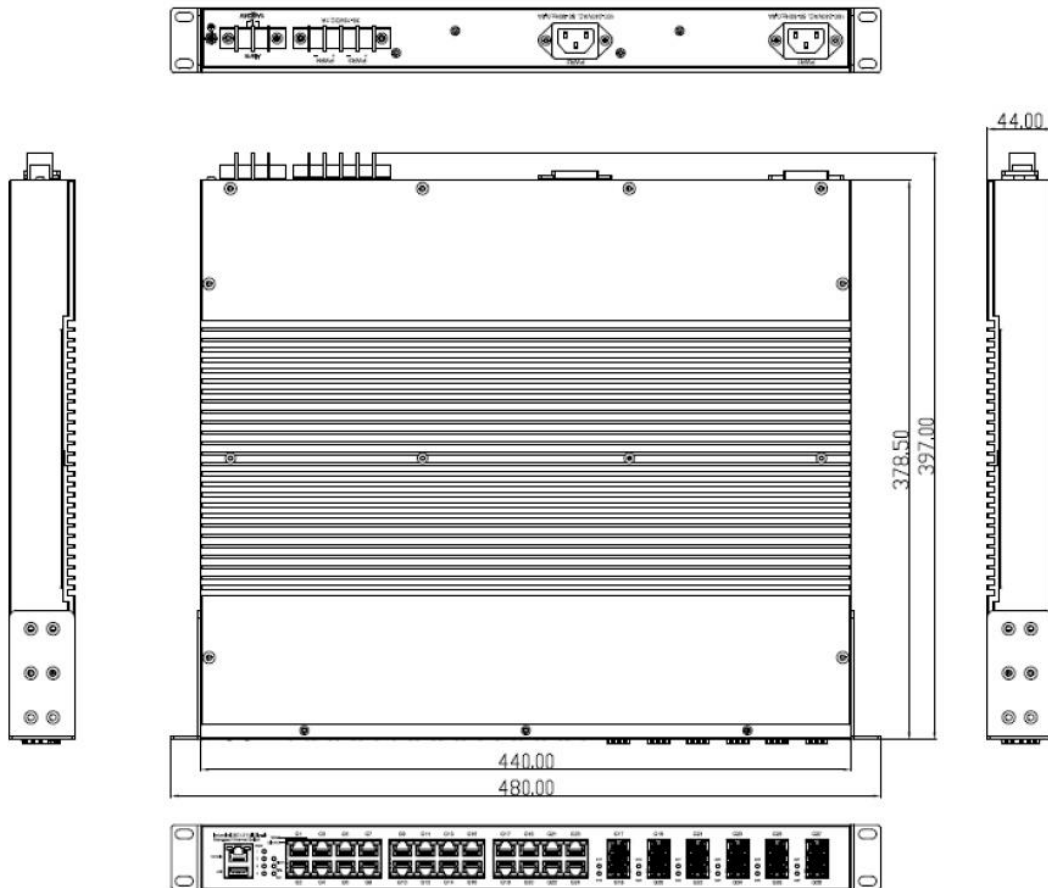

Panel Layout

The front panel includes RJ-45 based RS-232 Console Port, USB port, System & Port

LEDs, Gigabit Ethernet Port Interfaces and Gigabit Combo Port Interfaces

The back panel of the JetNet 6828Gf Industrial 28G L3 Full Gigabit Managed Ethernet Switch consists of 2 DC power inputs, 2 AC power Inputs and 1 Relay Output.

2.2 Wiring Power Inputs

JetNet 6828Gf provides 2 types power input, AC power input for JetNet 6828Gf-AC/6828Gf-2AC/6828Gf-AC-DC24 and DC power input for JetNet 6828Gf-AC-DC24/6828Gf-2DC24/6828Gf-2DC48. The front power switch can switch off all the power input at the same time.

JetNet JetNet 6828Gf-AC/6828Gf-2AC/6828Gf-AC-DC24 AC Power Input

Connect the attached power cord to the AC power input connector, the available AC power input is range from 90-264VAC.



JetNet 6828Gf-AC-DC24/6828Gf-2DC24/6828Gf-2DC48 DC Power Input

The suggested power input of JetNet 6828Gf-AC-DC24/6828Gf-2DC24 is 24VDC, the available range is from 18-36VDC.

The suggested power input of JetNet 6828Gf-2DC48 is 48VDC, the available range is from 36-75VDC.

Follow below steps to wire JetNet 6828Gf redundant DC power inputs.



1. Insert positive and negative wires into V+ and V- contacts respectively of the terminal block connector.
2. Tighten the wire-clamp screws to prevent DC wires from being loosened.
3. DC1 and DC2 support polarity reverse protection functions.

Note 1: It is a good practice to turn off input and load power, and to unplug power terminal block before making wire connections. Otherwise, your screwdriver blade can inadvertently short your terminal connections to the grounded enclosure.

Note 2: The range of the suitable DC electric wire is from 12 to 24 AWG.

Note 3: Please follow the V+ and V- indicator to wire. Incorrect wiring would not damage the switch. Incorrect wiring can not power on the switch.

2.3 Wiring Digital Output

JetNet 6828Gf series provides 1 digital output, also known as Relay Output. The relay contacts are energized (open) for normal operation and will close for fault conditions. The fault conditions include power failure, Ethernet port link break or other pre-defined events which can be configured in JetNet 6828Gf UI.

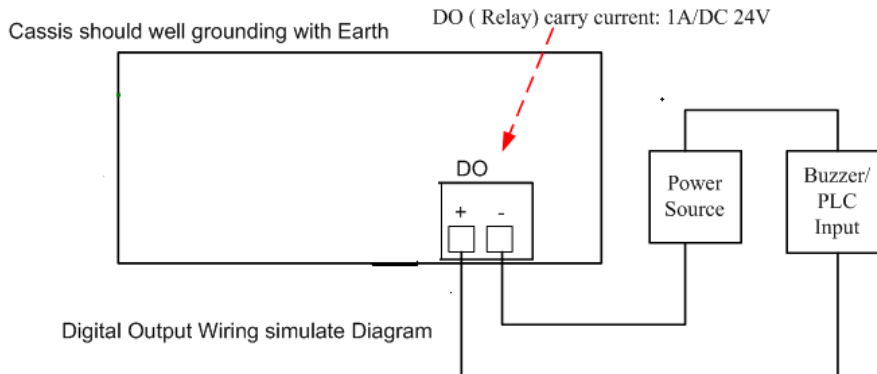

2.4 Wiring Earth Ground

To ensure the system will not be damaged by noise or any electrical shock, we suggest you to make exact connection with JetNet 6828Gf with Earth Ground.

For AC input, the 3 pin include V+, V- and GND. The GND pin must be connected to the earth ground.

For DC input, loosen the earth ground screw by screw drive; then tighten the screw after earth ground wire is connected.

2.5 Wiring Fast Ethernet Ports

JetNet 6828Gf includes 24 RJ-45 Gigabit Ethernet ports. The Gigabit Ethernet ports support 100Base-TX and 1000Base-TX, full or half duplex modes. All the Gigabit Ethernet ports will auto-detect the signal from connected devices to negotiate the link speed and duplex mode. Auto MDI/MDIX allows users to connect another switch, hub or workstation without changing straight through or crossover cables.

Note that crossover cables simply cross-connect the transmit lines at each end to the received lines at the opposite end.

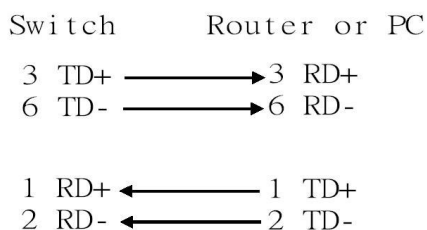

Straight-through Cabling Schematic

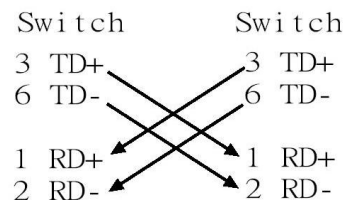

Cross-over Cabling Schematic

Note that Ethernet cables use pins 1, 2, 3, and 6 of an 8-pin RJ-45 connector. The signals

of these pins are converted by the automatic MDI-X function, as shown in the table below:

Pin MDI-X	Signals	MDI Signals
1	RD+	TD+
2	RD-	TD-
3	TD+	RD+
6	TD-	RD-

Connect one side of an Ethernet cable into any switch port and connect the other side to your attached device. The LNK LED will light up when the cable is correctly connected. Refer to the **LED Indicators** section for descriptions of each LED indicator. Always make sure that the cables between the switches and attached devices (e.g. switch, hub, or workstation) are less than 100 meters (328 feet).

The wiring cable types are as below.

10Base-T: 2-pair UTP/STP Cat. 3, 4, 5 cable, EIA/TIA-568 100-ohm (100m)

100 Base-TX: 2-pair UTP/STP Cat. 5 cable, EIA/TIA-568 100-ohm (100m)

1000 Base-TX: 4-pair UTP/STP Cat. 5 cable, EIA/TIA-568 100-ohm (100m)

2.6 Wiring Fiber Ports

Small Form-factor Pluggable (SFP)

The SFP ports accept standard Gigabit MINI GBIC SFP transceiver. But, to ensure system reliability, **Korenix recommends using the Korenix certified Gigabit SFP Transceiver**. The web UI will show Unknown vendor type when choosing the SFP which is not certificated by Korenix. The certificated SFP transceiver includes 100Base-FX single/multi mode, 100/Gigabit BIDI/WDM, 1000Base-SX/LX single/multi mode ranger from 550m to 80KM.

The way to connect the SFP transceiver is to Plug in SFP fiber transceiver fist. Cross-connect the transmit channel at each end to the receive channel at the opposite end as illustrated in the figure below. The SFP cage is 2x1 design, check the direction/angle of the fiber transceiver and fiber cable when inserted.

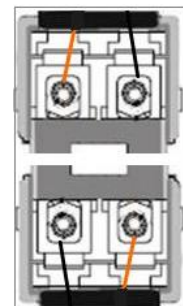
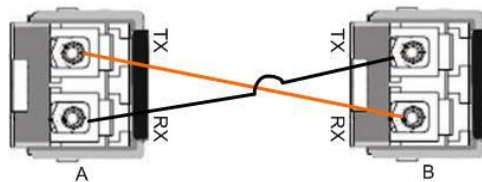

Below figure is the SFP plug-in and SFP Fiber Cable Plug-in Example.





Note: This is a Class 1 Laser/LED product. Don't stare at the Laser/LED Beam.

2.7 Wiring Gigabit Combo Ports

JetNet 6828Gf series includes 24 RJ-45 Gigabit Copper Ethernet ports. The speed of the Gigabit Copper Ethernet port supports 100Base-TX and 1000Base-TX. JetNet 6828Gf equips 8 Gigabit SFP ports combo with Gigabit Ethernet RJ-45 ports. JetNet 6828Gf equips 4 Gigabit SFP ports. **The speed of the SFP port supports 100MB and 1000Full Duplex.** The available gigabit SFP supports Gigabit Single-mode, Multi-mode, BIDI/WDM single-mode SFP transceivers. (The 100Base-FX is not supported in gigabit combo ports.)

While the SFP transceiver is plugged, the Fiber port has higher priority than copper port and moved to the Fiber mode automatically.

2.8 Wiring RS-232 Console Cable

JetNet 6828Gf attaches one RS-232 RJ-45 to DB-9 cable in the box. Connect the DB-9 connector to the COM port of your PC, open Terminal tool and set up serial settings to 115200, N,8,1. (Baud Rate: 115200/ Parity: None / Data Bit: 8 / Stop Bit: 1) Then you can access CLI interface by console cable.

Note: If you lost the cable, please contact with your sales or follow the pin assignment to buy a new one. The Pin assignment spec is listed in the appendix.

2.9 Rack Mounting Installation

The Rack Mount Kit is attached inside the package.

2.9.1 Attach the brackets to the device by using the screws provided in the Rack Mount kit.



(The picture is JetNet 5628G, the mounting method is the same.)

2.9.2 Mount the device in the 19' rack by using four rack-mounting screws provided by the rack manufacturer.



(The picture is JetNet 5628G, the mounting method is the same.)

When installing multiple switches, mount them in the rack one below the other. It's requested to **reserve 0.5U-1U free space for multiple switches installing in high temperature environment**. This is important to disperse the heat generated by the switch.

Notice when installing:

- Temperature: Check if the rack environment temperature conforms to the specified operating temperature range.
- Mechanical Loading: Do not place any equipment on top of the switch. In high vibration environment, additional rack mounting protection is necessary, like the flat board under/above the switch.
- Grounding: Rack-mounted equipment should be properly grounded.

2.10 Safety Warning

2.10.1 The Equipment intended for installation in a Restricted Access Location.



Restricted Access Location:

This equipment is intended to be installed in a RESTRICTED ACCESS LOCATION only.

2.10.2 The warning text is provided in user manual. Below is the information:

”For tilslutning af de øvrige ledere, se medfølgende installationsvejledning”.

”Laite on liitettävä suojamaadoitus-koskettimilla varustettuun pistorasiaan”

„Apparatet må tilkoples jordat stikkontakt“

”Apparaten skall anslutas till jordat uttag”

3 Preparation for Management

JetNet 6828Gf Rackmount Managed Switch provides both in-band and out-band configuration methods. You can configure the switch via RS232 console cable if you don't attach your admin PC to your network, or if you lose network connection to your JetNet 6828Gf. This is so-called out-band management. It wouldn't be affected by network performance.

The in-band management means you can remotely manage the switch via the network. You can choose Telnet or Web-based management. You just need to know the device's IP address and you can remotely connect to its embedded HTTP web pages or Telnet console.

Following topics are covered in this chapter:

3.1 Preparation for Serial Console

3.2 Preparation for Web Interface

3.3 Preparation for Telnet console

3.1 Preparation for Serial Console

In JetNet 6828Gf package, Korenix attached one RS-232 RJ-45 to DB-9 console cable. Please attach RS-232 DB-9 connector to your PC COM port, connect the other end to the Console port of the JetNet 6828Gf. Note: If you lost the cable, please contact with your sales or follow the pin assignment to buy a new one..

1. Go to Start -> Program -> Accessories -> Communication -> Hyper Terminal
2. Give a name to the new console connection.
3. Choose the COM name
4. Select correct serial settings. The serial settings of JetNet 6828Gf are as below:
Baud Rate: 115200 / Parity: None / Data Bit: 8 / Stop Bit: 1
5. After connected, you can see Switch login request.
6. Login the switch. The default username is "admin", password, "admin".

```
Boot Loader Rev 1.0.0.0 for JetNet6828Gf (Feb 26 2016 - 10:14:53)
Starting...

Switch login: admin
Password:

JetNet6828Gf (version 0.0.20-20151215-10:29:12).
Copyright 2006-2015 Korenix Technology Co., Ltd.

Switch>
```

3.2 Preparation for Web Interface

JetNet 6828Gf provides HTTP Web Interface and Secured HTTPS Web Interface for web management.

3.2.1 Web Interface

Korenix web management page is developed by JavaScript. It allows you to use a standard web-browser such as Microsoft Internet Explorer, or Mozilla, to configure and interrogate the switch from anywhere on the network.

Before you attempt to use the embedded web interface to manage switch operation, verify that your JetNet 6828Gf Series Rackmount Ethernet Switch is properly installed on your network and that every PC on this network can access the switch via the web browser.

1. Verify that your network interface card (NIC) is operational, and that your operating system supports TCP/IP protocol.
2. Wire DC power to the switch and connect your switch to your computer.
3. Make sure that the switch default IP address is 192.168.10.1.
4. Change your computer IP address to 192.168.10.2 or other IP address which is located in the 192.168.10.x (Network Mask: 255.255.255.0) subnet.
5. Switch to DOS command mode and ping 192.168.10.1 to verify a normal response time.

Launch the web browser and Login.

6. Launch the web browser (Internet Explorer or Mozilla Firefox) on the PC.
7. Type **http://192.168.10.1** (or the IP address of the switch). And then press **Enter**.
8. The login screen will appear next.
9. Key in user name and the password. Default user name and password are both **admin**.

Welcome to the JetNet6828Gf-AC

Name	<input type="text" value="admin"/>
Password	<input type="password"/>
	<input type="button" value="Login"/> <input type="button" value="Reset"/>

Click on **Enter** or **Login**. Welcome page of the web-based management interface will then appear.

Welcome to the JetNet6828Gf-AC Industrial Managed Switch

System Name	Switch
System Location	
System Contact	
System OID	1.3.6.1.4.1.24062.2.6.5
System Description	JetNet6828Gf-AC Industrial Managed Ethernet Switch
Firmware Version	0.0.25-20160524-20:35:35
Device Mac	001277FF8888

Apply

Once you enter the web-based management interface, you can freely change the JetNet's IP address to fit your network environment.

Note 1: The Web UI connection session of JetNet 6828Gf will be logged out automatically if you don't give any input after 30 seconds. After logged out, you should re-login and key in correct user name and password again.

3.2.2 Secured Web Interface

Korenix web management page also provides secured management HTTPS login. All the configuration commands will be secured and will be hard for the hackers to sniff the login password and configuration commands.

Launch the web browser and Login.

1. Launch the web browser (Internet Explorer or Mozilla Firefox) on the PC.
2. Type **https://192.168.10.1** (or the IP address of the switch). And then press **Enter**.
3. The popup screen will appear and request you to trust the secured HTTPS



connection distributed by JetNet 6828Gf first. Press **Yes** to trust it.

4. The login screen will appear next.

Welcome to the JetNet6828Gf-AC

Name

Password

5. Key in the user name and the password. The default user name and password is **admin**.
6. Click on **Enter** or **Login**. Welcome page of the web-based management interface will then appear.
7. Once you enter the web-based management interface, all the commands you see are the same as what you see by HTTP login.

3.3 Preparation for Telnet Console

3.3.1 Telnet

Korenix JetNet 6828Gf supports Telnet console. You can connect to the switch by Telnet and the command lines are the same as what you see by RS232 console port. Below are the steps to open Telnet connection to the switch.

1. Go to Start -> Run -> cmd. And then press **Enter**
2. Type the **Telnet 192.168.10.1** (or the IP address of the switch). And then press **Enter**

3.3.2 SSH (Secure Shell)

Korenix JetNet 6828Gf also support SSH console. You can remotely connect to the switch by command line interface. The SSH connection can secure all the configuration commands you sent to the switch.

SSH is a client/server architecture while JetNet 6828Gf is the SSH server. When you want to make SSH connection with the switch, you should download the SSH client tool first.

SSH Client

There are many free, sharewares, trials or charged SSH clients you can find on the internet. For example, PuTTY is a free and popular Telnet/SSH client. We'll use this tool to demonstrate how to login JetNet by SSH. Note: *PuTTY is copyright 1997-2006 Simon Tatham.*

Download PuTTY: <http://www.chiark.greenend.org.uk/~sgtatham/putty/download.html>

The copyright of **PuTTY**

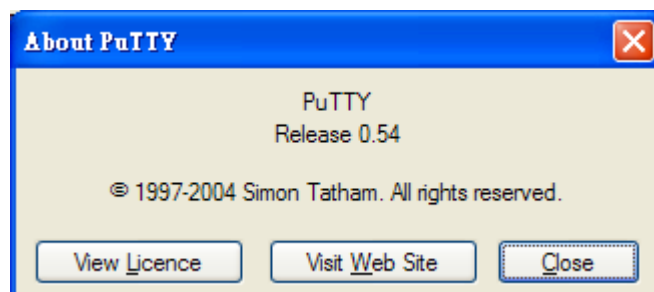

1. Open SSH Client/PuTTY. In the **Session** configuration, enter the **Host Name** (IP Address of your JetNet 6828Gf) and **Port number** (default = 22). Choose the “SSH” protocol. Then click on “Open” to start the SSH session console.

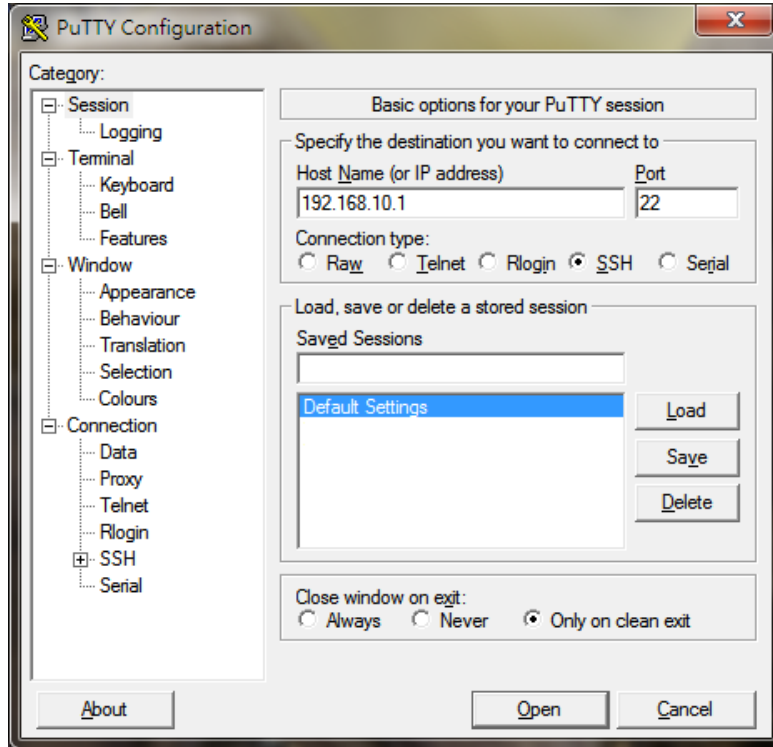

2. After click on **Open**, then you can see the cipher information in the popup screen. Press **Yes** to accept the Security Alert.

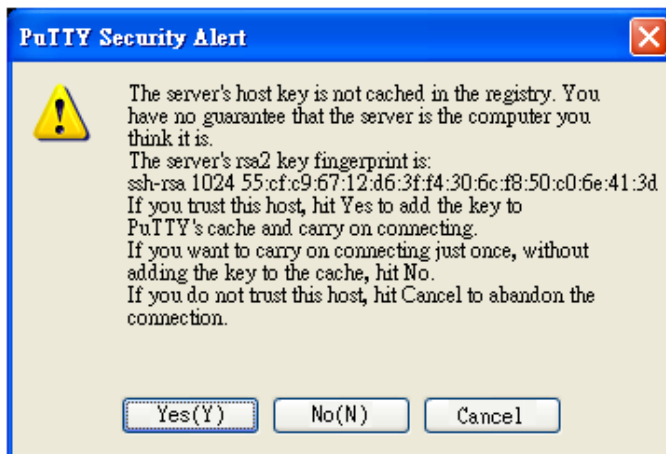

3. After few seconds, the SSH connection to JetNet 6828Gf is opened. You can see the login screen as the below figure.

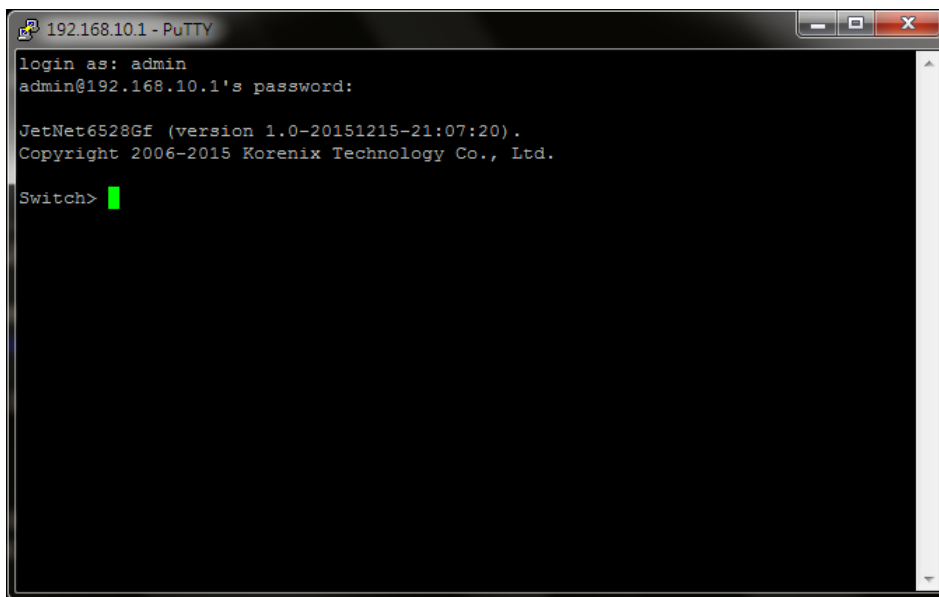

```
192.168.10.1 - PuTTY
login as: admin
admin@192.168.10.1's password:

JetNet6528Gf (version 1.0-20151215-21:07:20).
Copyright 2006-2015 Korenix Technology Co., Ltd.

Switch> █
```

4. Type the Login Name and its Password. The default Login Name and Password are **admin / admin**.
5. All the commands you see in SSH are the same as the CLI commands you see via RS232 console. The next chapter will introduce in detail how to use command line to configure the switch.

4 Feature Configuration

This chapter explains how to configure JetNet 6828Gf software features. There are four ways to access the switch: Serial console, Telnet, Web browser and SNMP.

JetNet 6828Gf series Rackmount Managed Switch provides both in-band and out-band configuration methods. You can configure the switch via RS232 console cable if you don't attach your admin PC to your network, or if you lose the network connection to your JetNet 6828Gf. This is so-called out-band management. It wouldn't be affected by the network performance.

The in-band management means you can remotely manage the switch via the network. You can choose Telnet or Web-based management. You just need to know the device's IP address. Then you can remotely connect to its embedded HTML web pages or Telnet console.

Korenix web management page is developed by JavaScript. It allows you to use a standard web-browser such as Microsoft Internet Explorer, or Mozilla, to configure and interrogate the switch from anywhere on the network.

Following topics are covered in this chapter:

- 4.1 Command Line Interface (CLI) Introduction
- 4.2 Basic Setting
- 4.3 Port Configuration
- 4.4 Network Redundancy
- 4.5 VLAN
- 4.6 Private VLAN
- 4.7 Traffic Prioritization
- 4.8 Multicast Filtering
- 4.9 Routing
- 4.10 SNMP
- 4.11 Security
- 4.12 Warning
- 4.13 Monitor and Diagnostic
- 4.14 Device Front Panel
- 4.15 Save to Flash
- 4.16 Logout

4.1 Command Line Interface Introduction

The Command Line Interface (CLI) is the user interface to the switch's embedded software system. You can view the system information, show the status, configure the switch and receive a response back from the system by keying in a command.

There are some different command modes. Each command mode has its own access ability, available command lines and uses different command lines to enter and exit. These modes are User EXEC, Privileged EXEC, Global Configuration, (Port/VLAN) Interface Configuration modes.

User EXEC mode: As long as you login the switch by CLI. You are in the User EXEC mode. You can ping, telnet remote device, and show some basic information.

Type **enable** to enter next mode, **exit** to logout. **?** to see the command list

Switch>	
enable	Turn on privileged mode command
exit	Exit current mode and down to previous mode
list	Print command list
ping	Send echo messages
quit	Exit current mode and down to previous mode
show	Show running system information
telnet	Open a telnet connection
traceroute	Trace route to destination

Privileged EXEC mode: Press enable in the User EXEC mode, then you can enter the Privileged EXEC mode. In this mode, the system allows you to view current configuration, reset default, reload switch, show system information, save configuration...and enter the global configuration mode.

Type **configure terminal** to enter next mode, **exit** to leave. **?** to see the command list

Switch#	
archive	manage archive files
clear	Reset functions
clock	Configure time-of-day clock
configure	Configuration from vty interface
copy	Copy from one file to another
debug	Debugging functions (see also 'undebug')
dir	Display a list of files
disable	Turn off privileged mode command
dot1x	IEEE 802.1x standard access security control
end	End current mode and change to enable mode
exit	Exit current mode and down to previous mode
list	Print command list
mac	MAC interface commands
no	Negate a command or set its defaults
pager	Terminal pager
ping	Send echo messages
quit	Exit current mode and down to previous mode
reboot	Reboot system
reload	copy a default-config file to replace the current one
show	Show running system information
telnet	Open a telnet connection
terminal	Set terminal line parameters
traceroute	Trace route to destination

usb	USB
write	Write running configuration to memory, network, or terminal

Global Configuration Mode: Press **configure terminal** in privileged EXEC mode. You can then enter global configuration mode. In global configuration mode, you can configure all the features that the system provides you.

Type **interface IFNAME/VLAN** to enter interface configuration mode, **exit** to leave. **?** to see the command list.

Available command lists of global configuration mode.

```
Switch# configure terminal
Switch(config)#
  access-list      Add an access list entry
  administrator    Administrator account setting
  auth             Authentication
  clock           Configure time-of-day clock
  default         Set a command to its defaults
  dot1x          IEEE 802.1x standard access security control
  end            End current mode and change to enable mode
  erps          Ethernet Ring Protection Switching (ITU-T G.8032)
  ethernet-ip    Ethernet/IP Protocol
  exit          Exit current mode and down to previous mode
  gmrp         GMRP protocol
  gvrp        GARP VLAN Registration Protocol
  hostname     Set system's network name
  interface    Select an interface to configure
  ip          Global IP configuration subcommands
  ipv6       IP information
  lacp      Link Aggregation Control Protocol
  list     Print command list
  lldp    Link Layer Discovery Protocol
  log     Logging control
  loop-protect Ethernet loop protection
  mac    Global MAC configuration subcommands
  mac-address-table mac address table
  mirror Port mirroring
  modbus Modbus TCP Slave
  multiple-super-ring Configure Multiple Super Ring
  nameserver DNS Server
  no       Negate a command or set its defaults
  ntp     Configure NTP
  ptp    IEEE1588 PTPv2
  qos    Quality of Service (QoS)
  relay  relay output type information
  router Enable a routing process
  service System service
  sfp    Small form-factor pluggable
  smtp-server SMTP server configuration
  snmp-server the SNMP server
  spanning-tree the spanning tree algorithm
  trunk     Trunk group configuration
  vlan     Virtual LAN
  warning-event Warning event selection
  write-config Specify config files to write to
```

(Port) Interface Configuration: Press **interface IFNAME** in global configuration mode. You can then enter interface configuration mode. In this mode, you can configure port settings.

The port interface name for fast Ethernet port 1 is fa1,... fast Ethernet 7 is fa7, gigabit Ethernet port 8 is gi8.. gigabit Ethernet port 10 is gi10. Type interface name accordingly when you want to enter certain interface configuration mode.

Type **exit** to leave.

Type **?** to see the command list

Available command lists of the global configuration mode.

```
Switch(config)# interface gi1
Switch(config-if)#
  acceptable          Configures the 802.1Q acceptable frame types of a port.
  auto-negotiation    Enables auto-negotiation state of a given port
  description         Interface specific description
  dot1x              IEEE 802.1x standard access security control
  duplex             Specifies the duplex mode of operation for a port
  end                End current mode and change to enable mode
  ethertype          Ethertype
  exit              Exit current mode and down to previous mode
  flowcontrol        Sets the flow-control value for an interface
  garp              General Attribute Registration Protocol
  ingress           802.1Q ingress filtering features
  ip                Interface Internet Protocol config commands
  lacp              Link Aggregation Control Protocol
  list              Print command list
  loopback          Specifies the loopback mode of operation for a port
  mac              MAC interface commands
  media-type        Specify media type
  mtu               Specifies the MTU on a port.
  no                Negate a command or set its defaults
  qos              Quality of Service (QoS)
  quit             Exit current mode and down to previous mode
  rate-limit        Rate limit configuration
  sfp              Small form-factor pluggable
  shutdown          Shutdown the selected interface
  spanning-tree     the spanning-tree protocol
  speed            Specifies the speed of a Fast Ethernet port or a Gigabit
                  Ethernet port.
  storm-control     Enables packets flooding rate limiting features
  switchport       Set switching mode characteristics
```

(VLAN) Interface Configuration: Press **interface VLAN VLAN-ID** in global configuration mode. You can then enter VLAN interface configuration mode. In this mode, you can configure the settings for the specific VLAN.

The VLAN interface name of VLAN 1 is VLAN 1, VLAN 2 is VLAN 2...

Type **exit** to leave the mode. Type **?** to see the available command list.

The command lists of the VLAN interface configuration mode.

```
Switch(config)# interface vlan1
Switch(config-if)#
```

description Interface specific description
 end End current mode and change to enable mode
 exit Exit current mode and down to previous mode
 ip Interface Internet Protocol config commands
 ipv6 Interface Internet Protocol config commands
 list Print command list
 no Negate a command or set its defaults
 quit Exit current mode and down to previous mode
 shutdown Shutdown the selected interface

Summary of the 5 command modes.

Command Mode	Main Function	Enter and Exit Method	Prompt
User EXEC	This is the first level of access. User can ping, telnet remote device, and show some basic information	Enter: login successfully Exit: exit to logout. Next mode: Type enable to enter privileged EXEC mode.	Switch>
Privileged EXEC	In this mode, the system allows you to view current configuration, reset default, reload switch, show system information, save configuration...and enter global configuration mode.	Enter: Type enable in User EXEC mode. Exec: Type disable to exit to user EXEC mode. Type exit to logout Next Mode: Type configure terminal to enter global configuration command.	Switch#
Global configuration	In global configuration mode, you can configure all the features that the system provides you	Enter: Type configure terminal in privileged EXEC mode Exit: Type exit or end or press Ctrl-Z to exit. Next mode: Type interface IFNAME/ VLAN VID to enter interface configuration mode	Switch(config)#
Port Interface configuration	In this mode, you can configure port related settings.	Enter: Type interface IFNAME in global configuration mode. Exit: Type exit or Ctrl+Z to global configuration mode. Type end to privileged EXEC mode.	Switch(config-if)#
VLAN Interface	In this mode, you can configure	Enter: Type interface VLAN	Switch(config-vlan)#

Configuration	settings for specific VLAN.	VID in global configuration mode. Exit: Type exit or Ctrl+Z to global configuration mode. Type end to privileged EXEC mode.	
---------------	-----------------------------	---	--

Here are some useful commands for you to see these available commands. Save your time in typing and avoid typing error.

? To see all the available commands in this mode. It helps you to see the next command you can/should type as well.

```
Switch(config)# interface (?)
  IFNAME  Interface's name
  vlan    Select a vlan to configure
```

(Character)? To see all the available commands starts from this character.

```
Switch(config)# a?
  access-list  Add an access list entry
  administrator Administrator account setting
  auth         Authentication
```

Tab This tab key helps you to input the command quicker. If there is only one available command in the next, clicking on tab key can help to finish typing soon.

```
Switch# con (tab) (tab)
Switch# configure terminal

Switch(config)# ac (tab)
Switch(config)# access-list
```

Ctrl+C To stop executing the unfinished command.

Ctrl+S To lock the screen of the terminal. You can't input any command.

Ctrl+Q To unlock the screen which is locked by Ctrl+S.

Ctrl+Z To exit configuration mode.

Alert message when multiple users want to configure the switch. If the administrator is in configuration mode, then the Web users can't change the settings. JetNet 6828Gf allows only one administrator to configure the switch at a time.

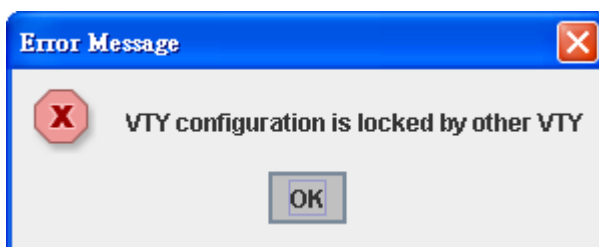

4.2 Basic Setting

The Basic Setting group provides you to configure switch information, IP address, User name/Password of the system. It also allows you to do firmware upgrade, backup and restore configuration, reload factory default, and reboot the system.

Following commands are included in this group:

- 4.2.1 Switch Setting
- 4.2.2 Admin Password
- 4.2.3 IP Configuration
- 4.2.4 Time Setting
- 4.2.5 Jumbo Frame
- 4.2.6 DHCP Server
- 4.2.7 Backup and Restore
- 4.2.8 Firmware Upgrade
- 4.2.9 Load Default
- 4.2.10 System Reboot
- 4.2.11 CLI Commands for Basic Setting

4.2.1 Switch Setting

You can assign System name, Location, Contact and view system information.

System Name	<input type="text" value="Switch"/>
System Location	<input type="text"/>
System Contact	<input type="text"/>
System OID	1.3.6.1.4.1.24062.2.6.5
System Description	JetNet6828Gf-AC Industrial Managed Ethernet Switch
Firmware Version	0.0.25-20160524-20:35:35
Device Mac	001277FF8888

Figure 4.2.1.1 – Web UI of the Switch Setting

System Name: You can assign a name to the device. The available characters you can input is 64. After you configure the name, CLI system will select the first 12 characters as the name in CLI system.

System Location: You can specify the switch's physical location here. The available characters you can input are 64.

System Contact: You can specify contact people here. You can type the name, mail address or other information of the administrator. The available characters you can input are 64.

System OID: The SNMP object ID of the switch. You can follow the path to find its private MIB in MIB browser. (**Note:** When you attempt to view private MIB, you should compile private MIB files into your MIB browser first.)

System Description: JetNet 6828Gf Industrial Managed Switch is the name of this product.

Firmware Version: Display the firmware version installed in this device.

MAC Address: Display unique hardware address (MAC address) assigned by the manufacturer.

Once you finish the configuration, click on **Apply** to apply your settings.

Note: Always remember to select **Save** to save your settings. Otherwise, the settings you made will be lost when the switch is powered off.

4.2.2 Admin Password

You can change the user name and the password here to enhance security.

Admin Password

Name	admin
Password
Confirm Password

Figure 4.2.2.1 Web UI of the Admin Password

User name: You can key in new user name here. The default setting is **admin**.

Password: You can key in new password here. The default setting is **admin**.

Confirm Password: You need to type the new password again to confirm it.

Once you finish configuring the settings, click on **Apply** to apply your configuration.

4.2.3 IP Configuration

This function allows users to configure the switch's IP address settings.

IP Configuration

DHCP Client ▼

IP Address	192.168.20.200
Subnet Mask	255.255.255.0
Default Gateway	192.168.10.254
DNS Server 1	8.8.8.8
DNS Server 2	

DHCP Client: You can select to **Enable** or **Disable** DHCP Client function. When DHCP Client function is enabled, an IP address will be assigned to the switch from the network's DHCP server. In this mode, the default IP address will therefore be replaced by the one assigned by DHCP server. If DHCP Client is disabled, then the IP address that you specified will be used instead.

IP Address: You can assign the IP address reserved by your network for your JetNet switch. If DHCP Client function is enabled, you don't need to assign an IP address to the JetNet switch, as it will be overwritten by DHCP server and shown here. The default IP is 192.168.10.1.

Subnet Mask: You can assign the subnet mask for the IP address here. If DHCP Client function is enabled, you don't need to assign the subnet mask. The default Subnet Mask is 255.255.255.0. **Note:** In the CLI, we use the enabled bit of the subnet mask to represent the number displayed in web UI. For example, 8 stands for 255.0.0.0; 16 stands for 255.255.0.0; 24 stands for 255.255.255.0.

Default Gateway: You can assign the gateway for the switch here. The default gateway is 192.168.10.254. **Note:** In CLI, we use 0.0.0.0/0 to represent for the default gateway.

DNS: You can assign the DNS for the switch here.

Once you finish configuring the settings, click on **Apply** to apply your configuration.

IPv6 Configuration –An IPv6 address is represented as eight groups of four hexadecimal digits, each group representing 16 bits (two octets). The groups are separated by colons (:), and the length of IPv6 address is 128bits.

An example of an IPv6 address is: 2001:0db8:85a3:0000:0000:8a2e:0370:7334.

The Leading zeroes in a group may be omitted. Thus, for example, a IPv6 link-local address may be written as: fe80::212:77ff:fe60:ca90.

IPv6 Configuration

IPv6 Address	Prefix
<input type="text"/>	<input type="text"/>

Add

IPv6 Address	Prefix
fe80::212:77ff:fe60:ca90	64
<input type="text"/>	<input type="text"/>

Remove **Reload**

IPv6 Address field: typing new IPv6 address in this field.

Prefix: the size of subnet or network, and it equivalent to the subnet mask, but written in different. The default subnet mask length is 64bits, and written in decimal value -64.

Add: after add new IPv6 address and prefix, don't forget click icon-**"Add"** to apply new address to system.

Remove: select existed IPv6 address and click icon-**"Remove"** to delete IP address.

Reload: refresh and reload IPv6 address listing.

IPv6 Default Gateway: assign the IPv6 default gateway here. Type IPv6 address of the gateway then click **"Apply"**. Note: In CLI, we user `::/0` to represent for the IPv6 default gateway.

IPv6 Default Gateway

Default Gateway
<input type="text"/>

Apply

IPv6Neighbor Table: shows the IPv6 address of neighbor, connected interface, MAC address of remote IPv6 device, and current state of neighbor device.

IPv6 Neighbor Table

Neighbor	Interface	MAC address	State
fe80::212:77ff:feff:101	vlan1	00:12:77:ff:01:01	REACHABLE

Reload

The system will update IPv6 Neighbor Table automatically, and user also can click the icon “Reload” to refresh the table.

4.2.4 Time Setting

Time Setting source allow user to set the time manually or through NTP server. Network Time Protocol (NTP) is used to synchronize computer clocks on the internet. You can configure NTP settings here to synchronize the clocks of several switches on the network.

The IEEE1588 PTP (Precision Time Protocol) supports very precise time synchronization in an Ethernet network. There are two clocks, Master and Slave. The master device periodically launches an exchange of messages with slave devices to help each slave clock re-compute the offset between its clock and the master's clock.

*Note: Please enable one synchronization protocol (PTP/NTP) only.

JetNet 6828Gf series also provides Daylight Saving function for some territories use.

Time Setting

System Time: Thu Jan 1 01:04:30 2015

Time Setting Source	Manual Setting						
Manual Setting	Get Time From PC						
Jan	01	, 2015	01	:	04	:	30

Manual Setting: User can select “Manual setting” to change time as user wants. User also can click the button “Get Time from PC” to get PC’s time setting for switch. After click the “Get Time from PC” and apply the setting, the System time display the same time as your PC’s time.

NTP client: Select the Time Setting Source to NTP client can let device enable the NTP client service. NTP client will be automatically enabled if you change Time source to NTP Client. The system will send request packet to acquire current time from the NTP server you assigned.

Time Setting Source	NTP Client
NTP Client	Manual Setting
Primary Server Address	NTP Client
	192.168.10.120
Secondary Server Address	192.168.10.121

IEEE 1588: select the **PTP State** to enable this function and select one operating mode for the precision time synchronizes.

IEEE 1588	
PTP State	Enable
Mode	Auto
Announce-interval	0(1s)
Announce-rcv-timeout	2
Delay-mechanism	E2E
Domain-number	0
Min-pdelay-req-interval	0(1s)
Priority1	0
Priority2	0
Sync-interval	0(1s)

Mode:

Auto mode: the switch performs PTP Master and slave mode.

Master mode: switch performs PTP Master only.

Slave mode: switch performs PTP slave only.

Announce-interval:

Select items: 0(1s) 1(2s) 2(4s) 3(8s) 4(16s)

Announce-rcv-timeout:

Select items:<2-10>

Delay-mechanism:

E2E: End-to-End

PTP: Peer-to-Peer

Domain-number:

Select items: <0-3>

Min-pdelay-req-interval:

Select items: -1(512ms) 0(1s) 1(2s) 2(4s) 3(8s) 4(16s)

Priority1:

First priority Select items: <0-255>

Priority2:

Second priority Select items: <0-255>

Sync-interval:

Select items: -3(128ms) -2(256ms) -1(512ms) 0(1s) 1(2s) 2(4s) 3(8s) 4(16s)

Timezone Setting									
Timezone	(GMT) Greenwich Mean Time: Dublin, Edinburgh, Lisbon, London ▼								
<input type="checkbox"/> Daylight Saving Time									
Daylight Saving Start	1st ▼	Sun ▼	in	Jan ▼	at	00 ▼	:	00 ▼	
Daylight Saving End	1st ▼	Sun ▼	in	Jan ▼	at	00 ▼	:	00 ▼	

Time-zone: Select the time zone where the switch is located. Following table lists the time zones for different locations for your reference. The default time zone is GMT Greenwich Mean Time.

- Switch(config)# clock timezone
- 01 (GMT-12:00) Eniwetok, Kwajalein
 - 02 (GMT-11:00) Midway Island, Samoa
 - 03 (GMT-10:00) Hawaii
 - 04 (GMT-09:00) Alaska
 - 05 (GMT-08:00) Pacific Time (US & Canada) , Tijuana
 - 06 (GMT-07:00) Arizona
 - 07 (GMT-07:00) Mountain Time (US & Canada)
 - 08 (GMT-06:00) Central America
 - 09 (GMT-06:00) Central Time (US & Canada)
 - 10 (GMT-06:00) Mexico City
 - 11 (GMT-06:00) Saskatchewan
 - 12 (GMT-05:00) Bogota, Lima, Quito
 - 13 (GMT-05:00) Eastern Time (US & Canada)
 - 14 (GMT-05:00) Indiana (East)
 - 15 (GMT-04:00) Atlantic Time (Canada)
 - 16 (GMT-04:00) Caracas, La Paz
 - 17 (GMT-04:00) Santiago
 - 18 (GMT-03:00) Newfoundland
 - 19 (GMT-03:00) Brasilia
 - 20 (GMT-03:00) Buenos Aires, Georgetown
 - 21 (GMT-03:00) Greenland
 - 22 (GMT-02:00) Mid-Atlantic
 - 23 (GMT-01:00) Azores
 - 24 (GMT-01:00) Cape Verde Is.
 - 25 (GMT) Casablanca, Monrovia
 - 26 (GMT) Greenwich Mean Time: Dublin, Edinburgh, Lisbon, London
 - 27 (GMT+01:00) Amsterdam, Berlin, Bern, Rome, Stockholm, Vienna
 - 28 (GMT+01:00) Belgrade, Bratislava, Budapest, Ljubljana, Prague
 - 29 (GMT+01:00) Brussels, Copenhagen, Madrid, Paris
 - 30 (GMT+01:00) Sarajevo, Skopje, Sofija, Vilnius, Warsaw, Zagreb
 - 31 (GMT+01:00) West Central Africa
 - 32 (GMT+02:00) Athens, Istanbul, Minsk
 - 33 (GMT+02:00) Bucharest
 - 34 (GMT+02:00) Cairo

- 35 (GMT+02:00) Harare, Pretoria
- 36 (GMT+02:00) Helsinki, Riga, Tallinn
- 37 (GMT+02:00) Jerusalem
- 38 (GMT+03:00) Baghdad
- 39 (GMT+03:00) Kuwait, Riyadh
- 40 (GMT+03:00) Moscow, St. Petersburg, Volgograd
- 41 (GMT+03:00) Nairobi
- 42 (GMT+03:30) Tehran
- 43 (GMT+04:00) Abu Dhabi, Muscat
- 44 (GMT+04:00) Baku, Tbilisi, Yerevan
- 45 (GMT+04:30) Kabul
- 46 (GMT+05:00) Ekaterinburg
- 47 (GMT+05:00) Islamabad, Karachi, Tashkent
- 48 (GMT+05:30) Calcutta, Chennai, Mumbai, New Delhi
- 49 (GMT+05:45) Kathmandu
- 50 (GMT+06:00) Almaty, Novosibirsk
- 51 (GMT+06:00) Astana, Dhaka
- 52 (GMT+06:00) Sri Jayawardenepura
- 53 (GMT+06:30) Rangoon
- 54 (GMT+07:00) Bangkok, Hanoi, Jakarta
- 55 (GMT+07:00) Krasnoyarsk
- 56 (GMT+08:00) Beijing, Chongqing, Hong Kong, Urumqi
- 57 (GMT+08:00) Irkutsk, Ulaan Bataar
- 58 (GMT+08:00) Kuala Lumpur, Singapore
- 59 (GMT+08:00) Perth
- 60 (GMT+08:00) Taipei
- 61 (GMT+09:00) Osaka, Sapporo, Tokyo
- 62 (GMT+09:00) Seoul
- 63 (GMT+09:00) Yakutsk
- 64 (GMT+09:30) Adelaide
- 65 (GMT+09:30) Darwin
- 66 (GMT+10:00) Brisbane
- 67 (GMT+10:00) Canberra, Melbourne, Sydney
- 68 (GMT+10:00) Guam, Port Moresby
- 69 (GMT+10:00) Hobart
- 70 (GMT+10:00) Vladivostok
- 71 (GMT+11:00) Magadan, Solomon Is., New Caledonia
- 72 (GMT+12:00) Auckland, Wellington
- 73 (GMT+12:00) Fiji, Kamchatka, Marshall Is.
- 74 (GMT+13:00) Nuku'alofa

Daylight Saving Time: Set when Enable Daylight Saving Time start and end, during the Daylight Saving Time, the device's time is one hour earlier than the actual time.

Once you finish your configuration, click on **Apply** to apply your configuration.

4.2.5 Jumbo Frame

The switch allows you configure the size of the MTU, Maximum Transmission Unit. The default value is 1,518 bytes. The maximum Jumbo Frame size is 9,216 bytes. You can freely change the available packet size.

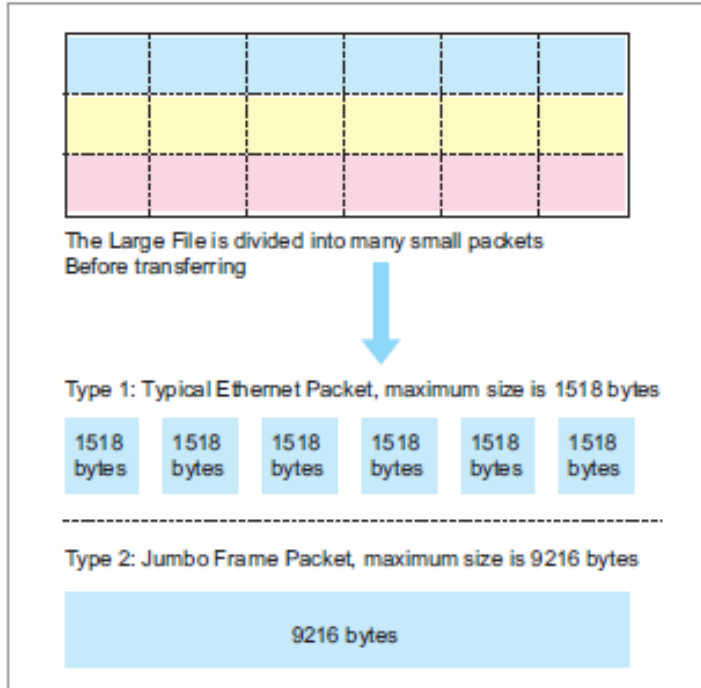

Jumbo Frame Setting

MTU size (<64-9216> bytes)

Port	MTU Size
1	9216
2	1500
3	5566
4	1518
5	1518
6	1518
7	1518
8	1518
9	1518
10	1518

Apply

Once you finish your configuration, click on **Apply** to apply your configuration.

4.2.6 DHCP Server

You can select to **Enable** or **Disable** DHCP Server function. *JetNet 6828Gf* will assign a

new IP address to link partners.

DHCP Server configuration

After selecting to enable DHCP Server function, type in the Network IP address for the DHCP server IP pool, Subnet Mask, Default Gateway address and Lease Time for client.

DHCP Server

DHCP Server Configuration

Network	192.168.10.0
Subnet Mask	255.255.255.0
Default Gateway	192.168.10.1
Lease Time(s)	604800

Apply

Once you have finished the configuration, click **Apply** to apply your configuration

Excluded Address:

You can type a specific address into the **IP Address field** for the DHCP server reserved IP address.

The IP address that is listed in the **Excluded Address List Table** will not be assigned to the network device. Add or remove an IP address from the **Excluded Address List** by clicking **Add** or **Remove**.

Excluded Address

IP Address	192.168.10.200
------------	----------------

Add

Excluded Address List

Index	IP Address
1	192.168.10.200

Remove

Manual Binding: *JetNet 6828Gf* provides a MAC address and IP address binding and removing function. You can type in the specified IP and MAC address, then click **Add** to add a new MAC&IP address binding rule for a specified link partner, like PLC or any device without **DHCP client** function. To remove from the binding list, just select the rule to

remove and click **Remove**.

Manual Binding

IP Address	<input type="text"/>
MAC Address	<input type="text"/>

Add

Manual Binding List

Index	IP Address	MAC Address

Remove

DHCP Leased Entries: *JetNet 6828Gf* provides an assigned IP address list for user check. It will show the MAC and IP address that was assigned by *JetNet 6828Gf*. Click the **Reload** button to refresh the listing.

DHCP Leased Entries

Index	Binding	IP Address	MAC Address	Lease Time(s)
1	Auto	192.168.0.3	0012.77ff.0530	604785

Reload

Option82 IP Address Configuration: The DHCP can assign IP address according to DHCP Option82 which sent from DHCP Relay Agent.

Option82 IP Address Configuration

IP Address	192.168.10.3
Circuit ID	00:01:00:03
Remote ID	relay-agent-a

Add

IP Address	Circuit ID	Type	Remote ID	Type
192.168.10.2	00:01:00:02	hex	00:12:77:ff:11:22	hex

Remove

Reload

DHCP Relay Agent: The DHCP Relay Agent is also known as DHCP Option 82. It can help relay the DHCP Request to remote DHCP server located in different subnet.

Note: The DHCP Server can not act with DHCP Relay Agent at the same time.

Relay Agent: Choose Enable or Disable the relay agent.

Relay Policy: The Relay Policy is used when the DHCP request is relayed through more than one switch. The switch can drop, keep or replace the MAC address of the DHCP Request packet.

Helper Address: Type the IP address of the target DHCP Server. There are 4 available IP addresses.

DHCP Relay Agent

Relay Agent

Relay Policy

Relay policy drop

Relay policy keep

Relay policy replace

Helper Address 1	192.168.10.254
Helper Address 2	
Helper Address 3	
Helper Address 4	

Apply

DHCP Option82: You can configure the DHCP Option82 setting of the Relay Agent. Choose 'Default' or you can input any string for Circuit-ID and Remote-ID. By default, Circuit-ID is the combination of VLAN-ID/Port number. Remote-ID is the MAC address of Relay Agent.

DHCP Option82 Relay Agent

Circuit-ID: Default Port 1 Circuit ID

Remote-ID: Default IP Address Remote ID

Apply

Remote-ID:

Port	Circuit ID	Display
1	00010001	00010001
2	00010002	00010002
3	11:22:33	112233
4	00010004	00010004
5	00010005	00010005
6	00010006	00010006

Reload

4.2.7 Backup and Restore

With Backup command, you can save current configuration file saved in the switch's flash to admin PC or TFTP server. This will allow you to go to **Restore** command later to restore the configuration file back to the switch. Before you restore the configuration file, you must place the backup configuration file in the PC or TFTP server. The switch will then download this file back to the flash.

There are 3 modes for users to backup/restore the configuration file, Local File mode, TFTP Server mode and USB mode.

Local File mode: In this mode, the switch acts as the file server. Users can browse the target folder and then type the file name to backup the configuration. Users can also browse the target folder and select existed configuration file to restore the configuration back to the switch. This mode is only provided by Web UI while CLI is not supported.

TFTP Server mode: In this mode, the switch acts as TFTP client. Before you do so, make sure that your TFTP server is ready. Then please type the IP address of TFTP Server and Backup configuration file name. This mode can be used in both CLI and Web UI.

USB mode: In this mode, the switch acts as USB control viewer. Before you do so, make sure that your USB already inserted into the switch. Then please select the file to Backup configuration file name, or to Restore Configuration. This mode can be used in both CLI and Web UI.

TFTP Server IP Address: You need to key in the IP address of your TFTP Server here.

Backup/Restore File Name: Please type the correct file name of the configuration file.

Configuration File: The configuration file of the switch is a pure text file. You can open it by word/txt read file. You can also modify the file, add/remove the configuration settings, and then restore back to the switch.

Startup Configuration File: After you saved the running-config to flash, the new settings will be kept and work after power cycle. You can use *show startup-config* to view it in CLI.

The Backup command can only backup such configuration file to your PC or TFTP server.

Technical Tip:

Default Configuration File: The switch provides the default configuration file in the system. You can use Reset button, Reload command to reset the system.

Running Configuration File: The switch's CLI allows you to view the latest settings running by the system. The information shown here is the settings you set up but haven't saved to flash. The settings not yet saved to flash will not work after power recycle. You can use show running-config to view it in CLI.

Once you finish selecting and configuring the settings, click on **Backup** or **Restore** to run

Figure 4.2.5.1 Main UI of Backup & Restore

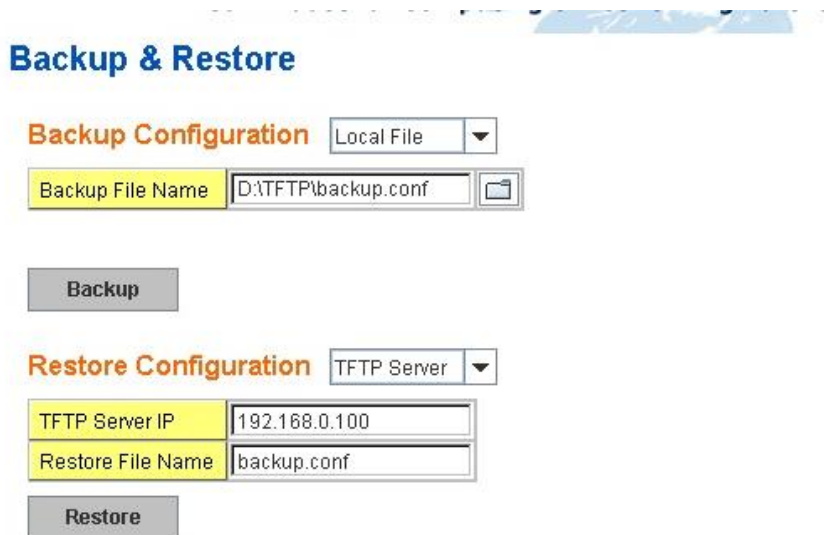
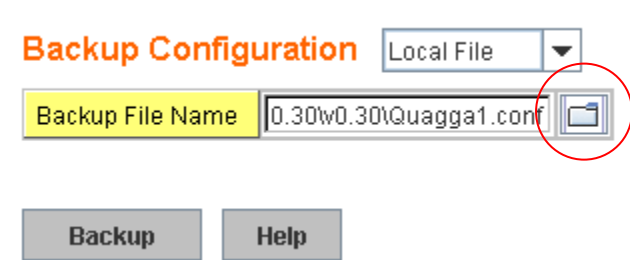



Figure 4.2.5.2 Bacup/Restore Configuration – Local File mode.



 Click on Folder icon to select the target file you want to backup/restore.

Note that the folders of the path to the target file do not allow you to input space key.

Figure 4.2.5.3 Backup/Restore Configuration – TFTP Server mode

Backup Configuration TFTP Server ▼

TFTP Server IP	192.168.0.100
Backup File Name	Backup1.conf

Backup

Type the IP address of TFTP Server IP. Then click on **Backup/Restore**.
Note: point to the wrong file will cause the entire configuration missed

Backup Configuration USB Storage ▼ Eject USB

Backup File Name

- JetNet6528Gf-v0.0.20.bin
- JetNet6528Gf-v1.0_b1.bin
- JetNet6528Gf-v1127.bin
- JetNet6528Gf-v1214.bin
- JetNet6910G-v1201.bin
- keygen.exe
- scrt73-x64.exe

Backup

Restore Configuration USB Storage ▼

- 556564
- 5566
- 55688
- 55789
- 6528C
- 6528config
- 6720config

Restore

USB mode: please select the file to Backup configuration file name, or to Restore Configuration.

4.2.8 Firmware Upgrade

In this section, you can update the latest firmware for your switch. Korenix provides the latest firmware in Korenix Web site. The new firmware may include new features, bug fixes

or other software changes. We'll also provide the release notes for the update as well. For technical viewpoint, we suggest you use the latest firmware before installing the switch to the customer site.

Note that the system will be automatically rebooted after you finished upgrading new firmware. Please remind the attached users before you do this.

Firmware Upgrade

System Firmware Version: v0.0.21 20151221

System Firmware Date: 20151218-10:59:11

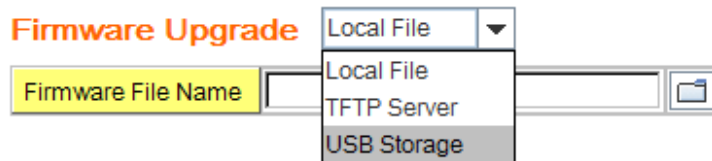

Note: When firmware upgrade is finished, the switch will restart automatically.

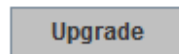

Figure 4.2.5.1 Main UI of Firmware Upgrade

There are 3 modes for users to backup/restore the configuration file, Local File mode , TFTP Server mode and USB storage mode.

Local File mode: In this mode, the switch acts as the file server. Users can browse the target folder and then type the file name to backup the configuration. Users also can browse the target folder and select the existed configuration file to restore the configuration back to the switch. This mode is only provided by Web UI while CLI is not supported.

TFTP Server mode: In this mode, the switch acts as the TFTP client. Before you do so, make sure that your TFTP server is ready. And then please type the IP address of TFTP Server IP address. This mode can be used in both CLI and Web UI.

USB storage mode. In this mode, the switch acts as USB control viewer. Before you do so, make sure that your USB already inserted into the switch. Then please select the firmware file name, then type the upgrade button to upgrade the firmware. This mode can be used in both CLI and Web UI.

TFTP Server IP Address: You need to key in the IP address of your TFTP Server here.

Firmware File Name: The file name of the new firmware.

The UI also shows you the current firmware version and built date of current firmware. Please check the version number after the switch is rebooted.

Figure 4.2.6.2 Firmware Upgrade – Local File mode.

Firmware Upgrade Local File ▼

Firmware File Name :5\images\JetNet6828Gf-v0.0.25.bin 



Click on Folder icon to select the target firmware file you want to upgrade.

Figure 4.2.6.3 Warning Message.

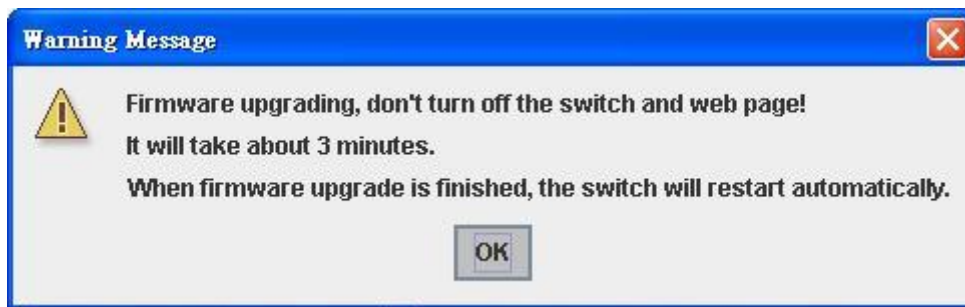
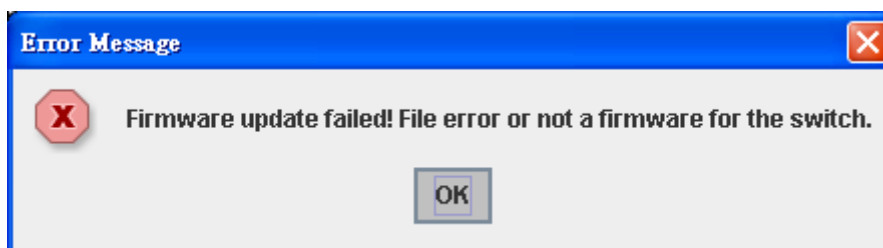

Figure 4.2.6.4 Error Message due to the file error or not a firmware for the switch.



Before upgrading firmware, please check the file name and switch model name first and carefully. Korenix switch provide protection when upgrading incorrect firmware file, the system would not crash even download the incorrect firmware. Even we have the protection, we still ask you don't try/test upgrade incorrect firmware; the unexpected event may occur or damage the system.

Figure 4.2.6.5 Firmware Upgrade – TFTP Server mode.

Firmware Upgrade TFTP Server ▼

TFTP Server IP 192.168.10.70

Firmware File Name JetNet6828Gf-v0.0.25.bin

Type the IP address of TFTP Server and Firmware File Name. Then click on **Upgrade** to start the process.

After finishing transmitting the firmware, the system will copy the firmware file and replace the firmware in the flash. The CLI show until the process is finished.

Figure 4.2.6.6 Firmware Upgrade – USB Storage mode.

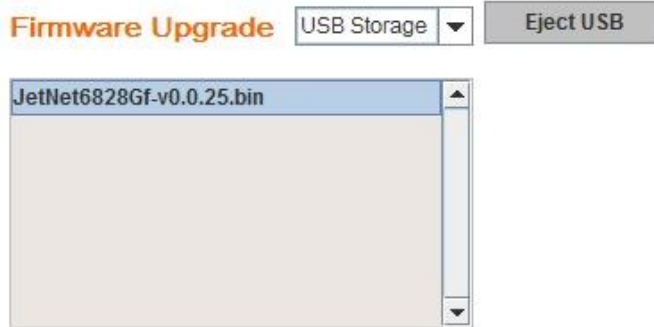

Note: When firmware upgrade is finished, the switch will restart automatically.

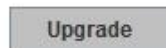

Select the firmware file name, then type the upgrade button to upgrade the firmware. It will start the firmware upgrade process.

After finishing transmitting the firmware, the system will copy the firmware file and replace the firmware in the flash. The CLI show until the process is finished.

4.2.9 Load Default

In this section, you can reset all the configurations of the switch to default setting. Click on **Reset** the system will then reset all configurations to default setting. The system will show you popup message window after finishing this command. Default setting will work after rebooting the switch.

Figure 4.2.7.1 The main screen of the Reset to Default

Reset to Default

Note: The command will reset all configurations to the default settings except the IP address.



Figure 4.2.7.2 Popup alert screen to confirm the command. Click on **Yes** to start it.

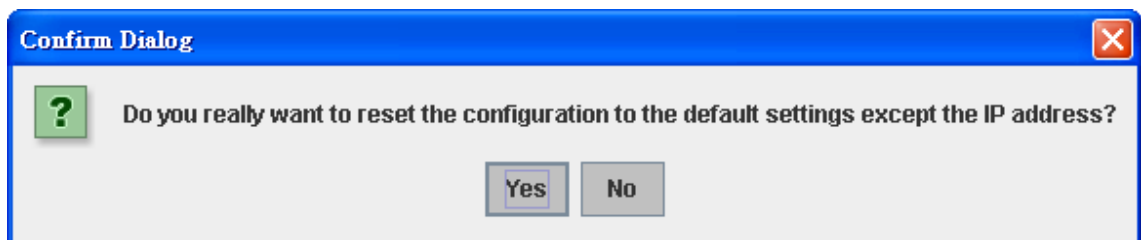
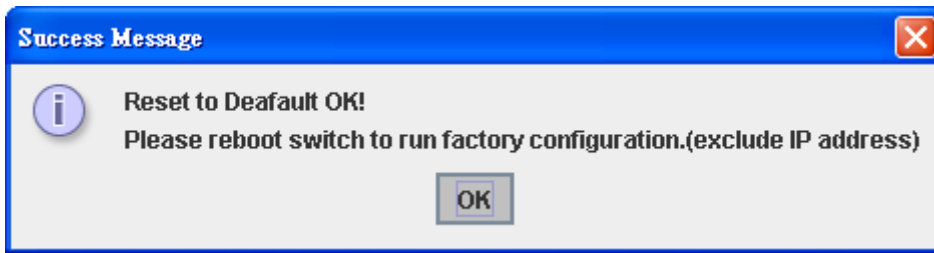

Figure 4.2.7.2 Popup message screen to show you that have done the command. Click on

OK to close the screen. Then please go to **Reboot** page to reboot the switch.



Click on **OK**. The system will then auto reboot the device.

Note: If you already configured the IP of your device to other IP address, when you use this command by CLI and Web UI, our software will not reset the IP address to default IP. The system will remain the IP address so that you can still connect the switch via the network.

4.2.10 System Reboot

System Reboot allows you to reboot the device. Some of the feature changes require you to reboot the system. Click on **Reboot** to reboot your device.

Note: Remember to click on **Save** button to save your settings. Otherwise, the settings you made will be gone when the switch is powered off.

Figure 4.2.8.1 Main screen for Rebooting

Reboot

Please click [Reboot] button to restart switch device.



Figure 4.2.8.2 Pop-up alert screen to request confirmation. Click on **Yes**. Then the switch will be rebooted immediately.

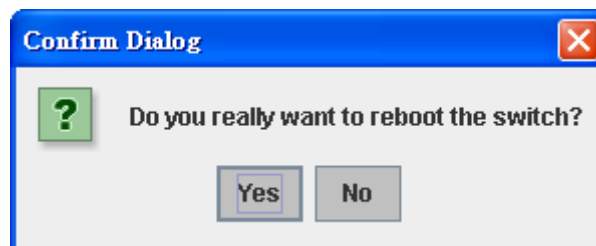
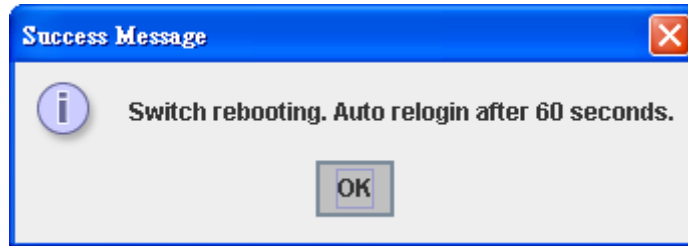

Figure 4.2.8.3 Pop-up message screen appears when rebooting the switch..



Note: Since different browser may has different behavior. If the Web GUI don't re-login well, please manually type the IP Address and login the system again.

4.2.11 CLI Commands for Basic Setting

Feature	Command Line
Switch Setting	
System Name	Switch(config)# hostname WORD Network name of this system Switch(config)# hostname JN6828Gf Switch(config)#
System Location	Switch(config)# snmp-server location Taipei
System Contact	Switch(config)# snmp-server contact korecare@korenix.com
Display	Switch# show snmp-server name Switch Switch# show snmp-server location Taipei Switch# show snmp-server contact korecare@korenix.com Switch# show version Hardware Information : Product Name : JetNet6828Gf-AC Serial Number : 12112314241 MAC Address : 001277FF0000 Manufacturing Date : 2015/11/04 Software Information : Loader Version : 1.0.0.0 Firmware Version : 1.0-20151215-21:07:20 Copyright 2006-2015 Korenix Technology Co., Ltd. Switc # show hardware led led information mac mac address Switch# show hardware mac MAC Address : 00:12:77:FF:01:B0 Switch# show hardware led DO 1 : Off RDY : On RM : Off RF : Off

Admin Password	
User Name and Password	Switch(config)# administrator NAME Administrator account name Switch(config)# administrator orwell PASSWORD Administrator account password Switch(config)# administrator orwell orwell Change administrator account orwell and password orwell success.
Display	Switch # show administrator Administrator account information name: orwell password: orwell
IP Configuration	
IP Address/Mask (192.168.10.8, 255.255.255.0	Switch(config)# int vlan 1 Switch(config-if)# ip address dhcp igmp Switch(config-if)# ip address 192.168.10.8/24 (DHCP Client) Switch(config-if)# ip dhcp client Switch(config-if)# ip dhcp client renew
Gateway	Switch(config)# ip route 0.0.0.0/0 192.168.10.254/24
Remove Gateway	Switch(config)# no ip route 0.0.0.0/0 192.168.10.254/24
Display	Switch# show interface vlan1 Interface vlan1 Description : N/A Administrative Status : Enable Operating Status : Up DHCP Client : Disable Primary IP Address : 192.168.10.8/24 IPv6 Address : fe80::212:77ff:feff:6666/64 Switch# show running-config ! interface vlan1 ip address 192.168.10.8/24 no shutdown ! ip route 0.0.0.0/0 192.168.10.254/24 !
IPv6 Address/Prefix	Switch(config)# interface vlan1 Switch(config-if)# ipv6 address 2001:0db8:85a3::8a2e:0370:7334/64
IPv6 Gateway	Switch(config)# ipv6 route 0::0/0 2001:0db8:85a3::8a2e:0370:FFFFE
Remove IPv6 Gateway	Switch(config)#no ipv6 route 0::0/0 2001:0db8:85a3::8a2e:0370:FFFFE
Display	Switch# show running-config interface vlan1 ip address 192.168.10.6/24 ipv6 address 2001:db8:85a3::8a2e:370:7334/64

	<pre>no shutdown ! ip route 0.0.0.0/0 192.168.10.254 ipv6 route ::/0 2001:db8:85a3::8a2e:370:ffe !</pre>
Time Setting	
NTP Server	<pre>Switch(config)# ntp peer enable disable primary secondary Switch(config)# ntp peer primary IPADDR Switch (config)# ntp peer primary 192.168.10.120</pre>
Time Zone	<pre>Switch(config)# clock timezone 26 Sun Jan 1 04:13:24 2006 (GMT) Greenwich Mean Time: Dublin, Edinburgh, Lisbon, London</pre> <p>Note: By typing clock timezone ?, you can see the timezone list. Then choose the number of the timezone you want to select.</p>
IEEE 1588	<pre>Switch(config)# ptpd run <cr> preferred-clock Preferred Clock slave Run as slave</pre>
Display	<pre>Switch# sh ntp associations Network time protocol Status : Disabled Primary peer : N/A Secondary peer : N/A</pre> <pre>Switch# show clock Sun Jan 1 04:14:19 2006 (GMT) Greenwich Mean Time: Dublin, Edinburgh, Lisbon, London</pre> <pre>Switch# show clock timezone clock timezone (26) (GMT) Greenwich Mean Time: Dublin, Edinburgh, Lisbon, London</pre> <pre>Switch# show ptpd PTPd is enabled Mode: Slave</pre>
Jumbo Frame	
Jumbo Frame	<pre>Type the maximum MTU to enable Jumbo Frame: Switch(config)# system mtu 1518 2000 2032 9712 (with VLAN tag) Switch(config)# system mtu 9712</pre> <pre>Disable Jumbo Frame: Switch (config)# no system mtu</pre>
Display	<pre>Switch# show system mtu System MTU size is 9712 bytes</pre>

	After disabled Jumbo Frame: Switch# show system mtu System MTU size is 2000 bytes
DHCP	
DHCP Commands	Switch(config)# router dhcp Switch(config-dhcp)# default-router DHCP Default Router end Exit current mode and down to previous enable mode exit Exit current mode and down to previous mode ip IP protocol lease DHCP Lease Time list Print command list network dhcp network no remove quit Exit current mode and down to previous mode service enable service
DHCP Server Enable	Switch(config-dhcp)# service dhcp <cr>
DHCP Server IP Pool (Network/Mask)	Switch(config-dhcp)# network A.B.C.D/M network/mask ex. 10.10.1.0/24 Switch(config-dhcp)# network 192.168.10.0/24
DHCP Server – Default Gateway	Switch(config-dhcp)# default-router A.B.C.D address Switch(config-dhcp)# default-router 192.168.10.254
DHCP Server – lease time	Switch(config-dhcp)# lease TIME second Switch(config-dhcp)# lease 1000 (1000 second)
DHCP Server – Excluded Address	Switch(config-dhcp)# ip dhcp excluded-address A.B.C.D IP address Switch(config-dhcp)# ip dhcp excluded-address 192.168.10.123 <cr>
DHCP Server – Static IP and MAC binding	Switch(config-dhcp)# ip dhcp static MACADDR MAC address Switch(config-dhcp)# ip dhcp static 0012.7700.0001 A.B.C.D leased IP address Switch(config-dhcp)# ip dhcp static 0012.7700.0001 192.168.10.99
DHCP Server – Option82 binding	Switch(config-dhcp)# ip dhcp option82 circuit-id string string input (using "any" if you don't want to specify CID) hex hexadecimal input Switch(config-dhcp)# ip dhcp option82 circuit-id hex 11:22:33 remote-id Remote-ID Switch(config-dhcp)# ip dhcp option82 circuit-id hex 11:22:33 remote-id string string input (using "any" if you don't want to specify RID) hex hexadecimal input Switch(config-dhcp)# ip dhcp option82 circuit-id hex 11:22:33 remote-id string relay-agent-a A.B.C.D leased IP address Switch(config-dhcp)# ip dhcp option82 circuit-id hex 11:22:33 remote-id string relay-agent-a 192.168.10.6
DHCP Relay –	Switch(config-dhcp)# ip dhcp relay information option Option82

Enable DHCP Relay	policy Option82 Switch(config-dhcp)# ip dhcp relay information option
DHCP Relay – DHCP policy	Switch(config-dhcp)# ip dhcp relay information policy drop Relay Policy keep Drop/Keep/Replace option82 field replace Switch(config-dhcp)# ip dhcp relay information policy drop <cr> Switch(config-dhcp)# ip dhcp relay information policy keep <cr> Switch(config-dhcp)# ip dhcp relay information policy replace <cr>
DHCP Relay – IP Helper Address	Switch(config-dhcp)# ip dhcp helper-address A.B.C.D Switch(config-dhcp)# ip dhcp helper-address 192.168.10.200
Reset DHCP Settings	Switch(config-dhcp)# ip dhcp reset <cr>
DHCP Server Information	Switch# show ip dhcp server statistics DHCP Server ON Address Pool 1 network:192.168.10.0/24 default-router:192.168.10.254 lease time:604800 Excluded Address List IP Address ----- 192.168.10.123 Manual Binding List IP Address MAC Address ----- ----- 0012.7701.0203 Leased Address List IP Address MAC Address Leased Time Remains ----- ----- -----
DHCP Relay Information	Switch# show ip dhcp relay DHCP Relay Agent ON IP helper-address : 192.168.10.200 Re-forwarding policy: Replace
Backup and Restore	
Backup Startup Configuration file	Switch# copy startup-config tftp: 192.168.10.33/default.conf Writing Configuration [OK] <i>Note 1: To backup the latest startup configuration file, you should save current settings to flash first. You can refer to 4.12 to see how to save settings to the flash. Note 2: 192.168.10.33 is the TFTP server's IP and default.conf is name of the configuration file. Your environment may use different IP addresses or different file name. Please type target TFTP server IP or file name in this command.</i>
Restore Configuration	Switch# copy tftp: 192.168.10.33/default.conf startup-config
Show Startup	Switch# show startup-config

Configuration	
Show Running Configuration	Switch# show running-config
Firmware Upgrade	
Firmware Upgrade	Switch# archive download-sw /overwrite tftp 192.168.10.33 JN6828Gf.bin Firmware upgrading, don't turn off the switch! Tftping file JN6828Gf.bin Firmware upgrading Firmware upgrade success!! Rebooting.....
Factory Default	
Factory Default	Switch# reload default-config file Reload OK! Switch# reboot
System Reboot	
Reboot	Switch# reboot

4.3 Port Configuration

Port Configuration group enables you to enable/disable port state, or configure port auto-negotiation, speed, and duplex, flow control, rate limit control and port aggregation settings. It also allows you to view port status and aggregation information.

Following commands are included in this group:

4.3.1 Understand the port mapping

4.3.2 Port Control

4.3.3 Port Status

4.3.4 Rate Control

4.3.5 Storm Control

4.3.6 Port Trunking

4.3.7 Command Lines for Port Configuration

4.3.1 Understand the port mapping

Before configuring the port settings, understand the port number in JetNet 6828Gf first.

There are 24 Gigabit Ethernet ports. In Web UI, choose the port number you want to configure, the available number from port 1~24. In CLI, use gi1, gi2...gi24 to present port 1 to port 24

As to the Gigabit Compo ports, it always uses port 25, 26, 27 and 28. In CLI use gi25, gi26, gi27 and gi28 to present the port 25-28.

4.3.2 Port Control

Port Control commands allow you to enable/disable port state, or configure the port auto-negotiation, speed, duplex and flow control.

Figure 4.3.2.1 The main Web UI of the Port Configuration.

Port Control

Port	State	Speed/Duplex	Flow Control	MDIX	Description
10	Enable	Auto Negotiation	Disable	Auto	
11	Enable	Auto Negotiation	Disable	Auto	
12	Enable	Auto Negotiation	Disable	Auto	
13	Enable	Auto Negotiation	Disable	Auto	
14	Enable	Auto Negotiation	Disable	Auto	
15	Enable	Auto Negotiation	Disable	Auto	
16	Enable	Auto Negotiation	Disable	Auto	
17	Enable	Auto Negotiation	Disable	Auto	
18	Enable	Auto Negotiation	Disable	Auto	
19	Enable	Auto Negotiation	Disable	Auto	

Apply

Select the port you want to configure and make changes to the port.

In **State** column, you can enable or disable the state of this port. Once you disable, the port stop to link to the other end and stop to forward any traffic. The default setting is Enable which means all the ports are workable when you receive the device.

In **Speed/Duplex** column, you can configure port speed and duplex mode of this port. Below are the selections you can choose:

Gigabit Ethernet Port 1~24 (gi1~gi24): AutoNegotiation, 10M Full Duplex(10 Full), 10M Half Duplex(10 Half), 100M Full Duplex(100 Full), 100M Half Duplex(100 Half), 1000M Full Duplex(1000 Full), and 1000M Half Duplex(1000 Half)

Gigabit Ethernet Combo Port 25~28: (gi25~gi28): AutoNegotiation, 10M Full Duplex(10 Full), 10M Half Duplex(10 Half), 100M Full Duplex(100 Full), 100M Half Duplex(100 Half), 1000M Full Duplex(1000 Full), and 1000M Half Duplex(1000 Half).

The default mode is Auto Negotiation mode.

Note: The on board Gigabit SFP port (SFP 25, 26, 27 and 28) in JetNet 6828Gf support 100M and 1000M Full mode.

In **Flow Control** column, "Symmetric" means that you need to activate the flow control function of the remote network device in order to let the flow control of that corresponding port on the switch to work. "Disable" means that you don't need to activate the flow control function of the remote network device, as the flow control of that corresponding port on the switch will work anyway.

In **Description** column, you can add description for the port. You can know the target it attached to easier in remote.

Once you finish configuring the settings, click on **Apply** to save the configuration.

Technical Tips: *If both ends are not at the same speed, they can't link with each other. If both ends are not in the same duplex mode, they will be connected by half mode.*

4.3.3 Port Status

Port Status shows you current port status after negotiated.

Port Status

Port	Type	Link	State	Speed/Duplex	Flow Control
1	1000BASE-TX	Up	Enable	1000 Full	Disable
2	1000BASE	Down	Enable	--	Disable
3	1000BASE	Down	Enable	--	Disable
4	1000BASE	Down	Enable	--	Disable
5	1000BASE	Down	Enable	--	Disable
6	1000BASE	Down	Enable	--	Disable
7	1000BASE	Down	Enable	--	Disable
8	1000BASE	Down	Enable	--	Disable
9	1000BASE	Down	Enable	--	Disable
10	1000BASE	Down	Enable	--	Disable

Reload

Figure 4.3.3.1 shows you the port status. The description of the columns is as below:

Port: Port interface number.

Type: 100BASE-TX -> Fast Ethernet copper port. 100BASE-FX -> 100Base-FX Fiber Port.
1000BASE-TX -> Gigabit Ethernet Copper port. 1000BASE-X-> Gigabit Fiber Port

Link: Link status. Up -> Link UP. Down -> Link Down.

State: Enable -> State is enabled. Disable -> The port is disable/shutdown.

Speed/Duplex: Current working status of the port.

Flow Control: The state of the flow control.

Note: The UI can display vendor name, wave length and distance of all Korenix Gigabit SFP transceiver family. If you see Unknown information, it may mean that the vendor doesn't provide their information or that the information of their transceiver can't be read.

4.3.4 Rate Control

Rate limiting is a form of flow control used to enforce a strict bandwidth limit at a port. You can program separate transmit (Egress Rule) and receive (Ingress Rule) rate limits at each port, and even apply the limit to certain packet types as described below.

Figure 4.3.4.1 shows you the Limit Rate of Ingress and Egress. You can type the volume in the blank. The volume of the JetNet 6828Gf is step by 64Kbps.

Rate Control

Limit Packet Rate

Port	Ingress Rate(Kbps)	Egress Rate(Kbps)
1	128	128
2	0	0
3	0	0
4	0	0
5	0	0
6	0	0
7	0	0
8	0	0
9	0	0
10	0	0

Apply

4.3.5 Storm Control

The Storm Control is similar to Rate Control. Rate Control filters all the traffic over the threshold you input by UI. Storm Control allows user to define the Rate for specific Packet Types.

Figure 4.3.5.1

Storm Control

Rate Configuration

Broadcast Rate(Kbytes/sec)	2000
DLF Rate(Kbytes/sec)	2000
Multicast Rate(Kbytes/sec)	2000

Port Configuration

Port	Broadcast	DLF	Multicast
1	Disable	Disable	Disable
2	Disable	Disable	Disable
3	Disable	Disable	Disable
4	Disable	Disable	Disable
5	Disable	Disable	Disable
6	Disable	Disable	Disable
7	Disable	Disable	Disable
8	Disable	Disable	Disable
9	Disable	Disable	Disable
10	Disable	Disable	Disable

Apply

Packet type: You can assign the Rate for specific packet types based on packet number per second. The packet types of the Ingress Rule listed here include **Broadcast, DLF (Destination Lookup Failure) and Multicast**. Choose **Enable/Disable** to enable or disable the storm control of specific port.

Rate: This column allows you to manually assign the limit rate of the port. The unit is packets per second. The limit range is from 1 to 262143 packets/sec.

Enter the Rate field of the port you want assign, type the new value and click Enter key first. After assigned or changed the value for all the ports you want configure. [Click on Apply to apply the configuration of all ports.](#) The Apply command applied all the ports' storm control value, it may take some time and the web interface become slow, this is normal condition.

4.3.6 Port Trunking

Port Trunking configuration allows you to group multiple Ethernet ports in parallel to increase link bandwidth. The aggregated ports can be viewed as one physical port so that the bandwidth is higher than merely one single Ethernet port. The member ports of the same trunk group can balance the loading and backup for each other. Port Trunking feature is usually used when you need higher bandwidth for backbone network. This is an inexpensive way for you to transfer more data.

There are some different descriptions for the port trunking. Different manufacturers may use different descriptions for their products, like Link Aggregation Group (LAG), Link Aggregation Control Protocol, Ethernet Trunk, Ether Channel...etc. Most of the implementations now conform to IEEE standard, 802.3ad.

The aggregated ports can interconnect to the other switch which also supports Port Trunking. Korenix Supports 2 types of port trunking. One is Static Trunk, the other is 802.3ad. When the other end uses 802.3ad LACP, you **should** assign 802.3ad LACP to the trunk. When the other end uses non-802.3ad, you can then use Static Trunk. **In practical, the Static Trunk is suggested.**

There are 2 configuration pages, Aggregation Setting and Aggregation Status.

Aggregation Setting

Port Trunk - Aggregation Setting

Port	Group ID	Trunk Type
1	None	Static
2	None	Static
3	None	Static
4	None	Static
5	None	Static
6	None	Static
7	None	Static
8	None	Static
9	None	Static
10	None	Static

Trunk ID	Load Balance Type
Trunk 1	src-dst-mac
Trunk 2	src-dst-mac
Trunk 3	src-dst-mac
Trunk 4	src-dst-mac
Trunk 5	src-dst-mac
Trunk 6	src-dst-mac
Trunk 7	src-dst-mac
Trunk 8	src-dst-mac

Note: The port parameters of the trunk members should be the same.
The Load Balance Type could be changed after enable Trunk or LACP.

Apply

Trunk Size: The switch can support up to 8 trunk groups. Each trunk group can support up to 8 member ports. Since the member ports should use same speed/duplex, the maximum trunk size is decided by the port volume.

Group ID: Group ID is the ID for the port trunking group. Ports with same group ID are in the same group. Click None, you can select the Trunk ID from Trunk 1 to Trunk 8.

Trunk Type: Static and 802.3ad LACP. Each Trunk Group can only support Static or 802.3ad LACP. Choose the type you need here. The not active port can't be setup here.

Load Balance Type: Each Trunk Group can support srcMAC, dstMAC, srcIP, dstIP and it's combination.

- src-mac -> load distribution is based on the source MAC address
- dst-mac -> load distribution is based on the destination-MAC address
- src-dst-mac -> load distribution is based on the source and destination MAC address
- src-ip -> load distribution is based on the source IP address
- dst-ip -> load distribution is based on the destination IP address
- src-dst-ip -> load distribution is based on the source and destination IP address

Extended setting in CLI:

Port Priority: The command allows you to change the port priority setting of the specific port. LACP port priority is configured on each port using LACP. The port priority can be configured through the CLI. The higher the number, the lower the priority. The default value is 32768.

LACP Timeout: The LACPDU is generated and continue transmit within the LACP group. The interval time of the LACPDU Long timeout is 30 sec, this is default setting. The LACPDP Short timeout is 1 sec, the command to change from Long to Short is only applied to the CLI, the web GUI doesn't support this. Once the LACP port doesn't receive the LACPDP 3 times, that means the port may leave the group without earlier inform or does not detect by the switch, then the port will be removed from the group.

This command can be used when connect the switch by 2-port LACP through not-direct connected or shared media, like the Wireless AP or Hub. The end of the switch may not directly detect the failure, the LACP Short Timeout can detect the LACP group failure earlier within 3 seconds.

Aggregation Status

This page shows the status of port aggregation. Once the aggregation ports are negotiated well, you will see following status.

Port Trunk - Aggregation Information

Group ID	Type	Aggregated Ports	Individual Ports	Link Down Ports
Trunk 1	Static	1		2,3,4
Trunk 2	LACP		8	9,10
Trunk 3				
Trunk 4				
Trunk 5				
Trunk 6				
Trunk 7				
Trunk 8				

Group ID: Display Trunk 1 to Trunk 8 set up in Aggregation Setting.

Type: Static or LACP set up in Aggregation Setting.

Aggregated: When LACP links well, you can see the member ports in Aggregated column.

Individual: When LACP is enabled, member ports of LACP group which are not connected to correct LACP member ports will be displayed in the Individual column.

Link Down: When LACP is enabled, member ports of LACP group which are not linked up will be displayed in the Link Down column.

4.3.7 Command Lines for Port Configuration

Feature	Command Line
Port Control	
Port Control – State	Switch(config-if)# shutdown -> Disable port state interface gigabitethernet1 is shutdown now. Switch(config-if)# no shutdown -> Enable port state Interface gigabitethernet1 is up now.
Port Control – Auto Negotiation	Switch(config)# interface gi1 Switch(config-if)# auto-negotiation Auto-negotiation of port 1 is enabled!
Port Control – Force Speed/Duplex	Switch(config-if)# speed 100 set the speed mode ok! Switch(config-if)# duplex full set the duplex mode ok!
Port Control – Flow Control	Switch(config-if)# flowcontrol on Flowcontrol on for port 1 set ok! Switch(config-if)# flowcontrol off

	Flowcontrol off for port 1 set ok!
Port Status	
Port Status	<pre>Switch# show interface gi1 Interface gigabitethernet1 Description : N/A Administrative Status : Enable Operating Status : Connected Duplex : Full Speed : 100 MTU: 1518 Flow Control :off Default Port VLAN ID: 1 Acceptable Frame Type : All Auto Negotiation : Disable Loopback Mode : None STP Status: forwarding Default CoS Value for untagged packets is 0. Medium mode is Copper.</pre> <p><i>Note: Administrative Status -> Port state of the port. Operating status -> Current status of the port. Duplex -> Duplex mode of the port. Speed -> Speed mode of the port. Flow control -> Flow Control status of the port.</i></p>
Rate Control	
Rate Control – Ingress or Egress	<pre>Switch(config-if)# rate-limit egress Outgoing packets ingress Incoming packets</pre> <p>Note: To enable rate control, you should select the Ingress or Egress rule first; then assign the packet type and bandwidth.</p>
Rate Control - Bandwidth	<pre>Switch(config-if)# rate-limit ingress bandwidth < 0-1000000 > Limit in kilobits per second (FE: 0-100000, GE: 0-1000000, 0 is no limit) Switch(config-if)# rate-limit ingress bandwidth 1600 Set the ingress rate limit 1600Kbps for Port 1..</pre>
Storm Control	
Strom Control – Rate Configuration (Packet Type)	<pre>Switch(config-if)# storm-control broadcast Broadcast packets dlf Destination Lookup Failure multicast Multicast packets</pre> <pre>SWITCH(config)# storm-control broadcast ? <0-262143> Rate limit value 0~262143 packet/sec SWITCH(config)# storm-control broadcast 1000 Enables rate limit for Broadcast packets for Port 1 SWITCH(config)# storm-control multicast 1000 Enables rate limit for Multicast packets for Port 1 SWITCH(config)# storm-control dlf 1000 Enables rate limit for Destination Lookup Failue packets for Port1.</pre>
Display – Rate	<pre>SWITCH# show storm-control Storm-control for Port 1</pre>

Configuration and port status	<p>Broadcast packets : Disabled Rate : 1000 (packets/s)</p> <p>Destination Lookup Failure packets : Enabled Rate : 1000 (packets/s)</p> <p>Multicast packets : Disabled Rate : 1000 (packets/s)</p> <p>Storm-control for Port 2</p> <p>Broadcast packets : Disabled Rate : N/A (packets/s)</p> <p>Destination Lookup Failure packets : Disabled Rate : N/A (packets/s)</p> <p>Multicast packets : Disabled Rate : N/A (packets/s)</p> <p>Storm-control for Port 3</p> <p>Broadcast packets : Disabled Rate : N/A (packets/s)</p> <p>Destination Lookup Failure packets : Disabled Rate : N/A (packets/s)</p> <p>Multicast packets : Disabled Rate : N/A (packets/s)</p> <p>.....</p>
Port Trunking	
LACP	<p>Switch(config)# lacp group 1 fa8-10</p> <p>Group 1 based on LACP(802.3ad) is enabled!</p> <p><i>Note: The interface list is fa1,fa3-5, fa8-10</i></p> <p>Note: different speed port can't be aggregated together.</p>
LACP – Port Setting	<p>SWITCH(config-if)# lacp</p> <p>port-priority LACP priority for physical interfaces</p> <p>timeout assigns an administrative LACP timeout</p> <p>SWITCH(config-if)# lacp port-priority</p> <p><1-65535> Valid port priority range–1 - 65535 (default is 32768)</p> <p>SWITCH(config-if)# lacp timeout</p> <p>long specifies a long timeout value (default)</p> <p>short specifies a short timeout value</p> <p>SWITCH(config-if)# lacp timeout short</p> <p>Set lacp port timeout ok.</p>
Static Trunk	<p>Switch(config)# trunk group 2 fa6-7</p> <p>Trunk group 2 enable ok!</p> <p>Failure to configure due to the group ID is existed.</p> <p>SWITCH(config)# trunk group 1 fa11-12</p> <p>'an't set trunk group 1 enable!</p> <p>The group 1 is a lacp enabled group!</p> <p>SWITCH(config)# trunk group 2 fa11-12</p> <p>'an't set trunk group 2 enable!</p> <p>The group 2 is a static aggregation group.</p>
Display - LACP	<p>Switch# show lacp</p> <p>counters LACP statistical information</p> <p>group LACP group</p> <p>internal LACP internal information</p> <p>neighbor LACP neighbor information</p> <p>port-setting LACP setting for physical interfaces</p>

	<pre> system-id LACP system identification system-priority LACP system priority SWITCH# show lacp port-setting LACP Port Setting : Port Priority Timeout ----- 1 32768 Long 2 32768 Long 3 32768 Long Switch# show lacp internal LACP group 1 internal information: LACP Port Admin Oper Port Port Priority Key Key State ----- 8 1 8 8 0x45 9 1 9 9 0x45 10 1 10 10 0x45 LACP group 2 is inactive LACP group 3 is inactive LACP group 4 is inactive </pre>
<p>Display - Trunk</p>	<pre> Switch# show trunk group 1 FLAGS: I -> Individual P -> In channel D -> Port Down Trunk Group GroupID Protocol Ports -----+-----+----- 1 LACP 8(D) 9(D) 10(D) </pre>

4.4 Network Redundancy

It is critical for industrial applications that network remains non-stop. Korenix develops multiple kinds of standard (STP, RSTP and MSTP) and Korenix patterned redundancy protocol, Multiple Super Ring to remain the network redundancy can be protected well by Korenix switch.

The JetNet 6828Gf Series supports advanced Multiple Spanning Tree Protocol (MSTP). This protocol is a direct extension of RSTP. It can provide an independent spanning tree for different VLANs. It simplifies network management, provides for even faster convergence than RSTP by limiting the size of each region, and prevents VLAN members from being segmented from the rest of the group (as sometimes occurs with IEEE 802.1D STP).

Multiple Super Ring (MSR) technology is *Korenix's* 3rd generation Ring redundancy technology. This is patented and protected by *Korenix* and is used in countries all over the world. MSR ranks the fastest restore and failover time in the world, 0 ms for restore and about 5 milliseconds for failover for copper.

The single Korenix switch can aggregate multiple Rings within one switch. All the ports can be configured as the ring port of a ring, each ring has its own Ring ID and the Ring ID will be added to the watchdog packet to monitor the ring status. This is Korenix Patterned MultiRing Technology.

The Ring ports can be LACP/Port Trunking ports, after aggregated ports to a group, the group of ports can act as the Ring port of the Ring. This is Korenix Patterned TrunkRing Technology.

Advanced Rapid Dual Homing(RDH) technology also facilitates *JetNet switch* to connect with a core managed switch easily and conveniently. With RDH technology, you can also couple several Rapid Super Rings or RSTP cloud together.

Following commands are included in this group:

4.4.1 STP Configuration

4.4.2 STP Port Configuration

4.4.3 STP Information

4.4.4 MSTP Configuration

4.4.5 MSTP Port Configuration

4.4.6 MSTP information

4.4.7 Multiple Super Ring

4.4.8 Multiple Super Ring Information

4.4.9 ERPS Configuration

4.4.10 Command Lines for Network Redundancy

The STP Configuration, STP Port Configuration and STP Information pages are available while select the STP and RSTP mode.

The MSTP Configuration, MSTP Port Configuration and MSTP Information pages are available while select the MSTP mode.

The Multiple Super Ring and Multiple Super Ring Information are available while select the MSR mode.

4.4.1 STP Configuration

This page allows select the STP mode and configuring the global STP/RSTP Bridge Configuration.

The STP mode includes the **STP**, **RSTP**, **MSTP** and **Disable**. Please select the STP mode for your system first. The default mode is RSTP enabled.

After select the STP or RSTP mode, continue to configure the global Bridge parameters for STP and RSTP.

After select the MSTP mode, please go to MSTP Configuration page.

Figure 4.4.1.1 show the web page which allows you to select the STP mode, configure the global STP/RSTP/MSTP settings.

STP Configuration

STP Mode RSTP ▼

Bridge Configuration

Bridge Address	0012.7700.0000
Bridge Priority	32768 ▼
Max Age	20 ▼
Hello Time	2 ▼
Forward Delay	15 ▼

Apply

RSTP (Refer to the 4.4.1 of previous version manual.)

RSTP is the abbreviation of Rapid Spanning Tree Protocol. If a switch has more than one path to a destination, it will lead to message loops that can generate broadcast storms and quickly bog down a network. The spanning tree was created to combat the negative effects of message loops in switched networks. A spanning tree uses a spanning tree algorithm (STA) to automatically sense whether a switch has more than one way to communicate with a node. It will then select the best path (primary), and block the other path(s). It will also keep track of the blocked path(s) in case the primary path fails. Spanning Tree Protocol (STP) introduced a standard method to accomplish this. It is specified in IEEE 802.1D-1998. Later, Rapid Spanning Tree Protocol (RSTP) was adopted and represents the evolution of STP, providing much faster spanning tree convergence after a topology change. This is specified in IEEE 802.1w. In 2004, 802.1w is included into 802.1D-2004 version. This switch supports both RSTP and STP (all switches that support RSTP are also backward compatible with switches that support only STP).

Bridge Configuration

Priority (0-61440): RSTP uses bridge ID to determine the root bridge, the bridge with the highest bridge ID becomes the root bridge. The bridge ID is composed of bridge priority and bridge MAC address. So that the bridge with the highest priority becomes the highest

bridge ID. If all the bridge ID has the same priority, the bridge with the lowest MAC address will then become the root bridge.

Note: The bridge priority value must be in multiples of 4096. A device with a lower number has a higher bridge priority. Ex: 4096 is higher than 32768.

Note: The Web GUI allows user select the priority number directly. This is the convenient of the GUI design. When you configure the value through the CLI or SNMP, you may need to type the value directly. Please follow the $n \times 4096$ rule for the Bridge Priority.

Max Age (6-40): Enter a value from 6 to 40 seconds here. This value represents the time that a bridge will wait without receiving Spanning Tree Protocol configuration messages before attempting to reconfigure.

If JetNet is not the root bridge, and if it has not received a hello message from the root bridge in an amount of time equal to Max Age, then JetNet will reconfigure itself as a root bridge. Once two or more devices on the network are recognized as a root bridge, the devices will renegotiate to set up a new spanning tree topology.

The MAX Age value affects the maximum volume of the RSTP loop. In the RSTP BPDU packet, there is one field, message age which start from 0, add 1 after passed one hop in the RSTP loop. When the message age is larger than MAX Age, the BPDU would be ignored and the lower switches are separated to different RSTP domain. The switches in other RSTP domain can't be managed through upper switch.

Since different RSTP aware switches may have their own mechanism to calculate the message age. So that this is most possibly occurred when interoperate different vendors' RSTP aware switches together. The maximum volume of the Korenix RSTP domain is 23, configure the MAX Age lower than 23 is recommended.

Hello Time (1-10): Enter a value from 1 to 10 seconds here. This is a periodic timer that drives the switch to send out BPDU (Bridge Protocol Data Unit) packet to check current STP status.

The root bridge of the spanning tree topology periodically sends out a "hello" message to other devices on the network to check if the topology is "healthy". The "hello time" is the amount of time the root has waited during sending hello messages.

Forward Delay Time (4-30): Enter a value between 4 and 30 seconds. This value is the time that a port waits before changing from Spanning Tree Protocol learning and listening states to forwarding state.

This is the amount of time JetNet will wait before checking to see if it should be changed to a different state.

Once you have completed your configuration, click on **Apply** to apply your settings.

Note: You must observe the following rule to configure Hello Time, Forwarding Delay, and Max Age parameter

$2 \times (\text{Forward Delay Time} - 1 \text{ sec}) \geq \text{Max Age Time} \geq 2 \times (\text{Hello Time value} + 1 \text{ sec})$

4.4.2 STP Port Configuration

This page allows you to configure the port parameter after enabled STP or RSTP.

Port Configuration

Select the port you want to configure and you will be able to view current settings and status of the port.

Path Cost: Enter a number between 1 and 200,000,000. This value represents the "cost" of the path to the other bridge from the transmitting bridge at the specified port.

Priority: Enter a value between 0 and 240, using multiples of 16. This is the value that

decides which port should be blocked by priority in a LAN.

Link Type: There are 3 types for you select. **Auto**, **P2P** and **Share**.

Some of the rapid state transitions that are possible within RSTP depend upon whether the port of concern can only be connected to another bridge (i.e. it is served by a point-to-point LAN segment), or if it can be connected to two or more bridges (i.e. it is served by a shared-medium LAN segment). This function allows link status of the link to be manipulated administratively. “**Auto**” means to auto select P2P or Share mode. “**P2P**” means P2P is enabled, the 2 ends work in Full duplex mode. While “**Share**” is enabled, it means P2P is disabled, the 2 ends may connect through a share media and work in Half duplex mode.

Edge Port: A port directly connected to the end stations cannot create a bridging loop in the network. To configure this port as an edge port, set the port to the **Enable** state. When the non-bridge device connects an admin edge port, this port will be in blocking state and turn to forwarding state in 4 seconds.

STP Port Configuration

Port	STP State	Path Cost	Priority	Link Type	Edge Port
1	Enable	100	128	Auto	Enable
2	Enable	20000	128	Auto	Enable
3	Enable	20000	128	Auto	Enable
4	Enable	20000	128	Auto	Enable
5	Enable	20000	128	Auto	Enable
6	Enable	20000	128	Auto	Enable
7	Enable	20000	128	Auto	Enable
8	Enable	20000	128	Auto	Enable
9	Enable	20000	128	Auto	Enable
10	Enable	20000	128	Auto	Enable

Apply

Once you finish your configuration, click on **Apply** to save your settings.

4.4.3 RSTP Info

This page allows you to see the information of the root switch and port status.

RSTP Information

Root Information

Bridge ID	8000.0012.7760.1455
Root Priority	32768
Root Port	N/A
Root Path Cost	0
Max Age(6-40)	20 sec
Hello Time(1-10)	2 sec
Forward Delay(4-30)	15 sec

Port Information

Port	Role	Port State	Path Cost	Port Priority	Oper P2P	Oper Edge	Aggregated(ID/Type)
1	--	Disabled	200000	128	P2P	Edge	--
2	--	Disabled	200000	128	Shared	Edge	--
3	Designated	Forwarding	200000	128	P2P	Non-Edge	--
4	--	Disabled	200000	128	Shared	Edge	--
5	--	Disabled	200000	128	Shared	Edge	--
6	--	Disabled	200000	128	Shared	Edge	--
7	--	Disabled	200000	128	Shared	Edge	--
8	--	Disabled	200000	128	P2P	Edge	--
9	Designated	Forwarding	200000	128	P2P	Edge	--
10	Designated	Forwarding	200000	128	P2P	Edge	--

Root Information: You can see root Bridge ID, Root Priority, Root Port, Root Path Cost and the Max Age, Hello Time and Forward Delay of BPDU sent from the root switch.

Port Information: You can see port Role, Port State, Path Cost, Port Priority, Oper P2P mode, Oper edge port mode and Aggregated(ID/Type).

4.4.4 MSTP (Multiple Spanning Tree Protocol) Configuration

MSTP is the abbreviation of Multiple Spanning Tree Protocol. This protocol is a direct extension of RSTP. It can provide an independent spanning tree for different VLANs. It simplifies network management, provides for even faster convergence than RSTP by limiting the size of each region, and prevents VLAN members from being segmented from the rest of the group (as sometimes occurs with IEEE 802.1D STP).

While using MSTP, there are some new concepts of network architecture. A switch may belong to different groups, act as root or designate switch, generate BPDU for the network to maintain the forwarding table of the spanning tree. With MSTP can also provide multiple forwarding paths and enable load balancing. Understand the architecture allows you to maintain the correct spanning tree and operate effectively.

One VLAN can be mapped to a Multiple Spanning Tree Instance (MSTI). For example, the

maximum Instance JetNet supports is usually 16, range from 0-15. The MSTP builds a separate Multiple Spanning Tree (MST) for each instance to maintain connectivity among each of the assigned VLAN groups. An Internal Spanning Tree (IST) is used to connect all the MSTP switches within an MST region. An MST Region may contain multiple MSTP Instances.

The figure shows there are 2 VLANs/MSTP Instances and each instance has its Root and forwarding paths.

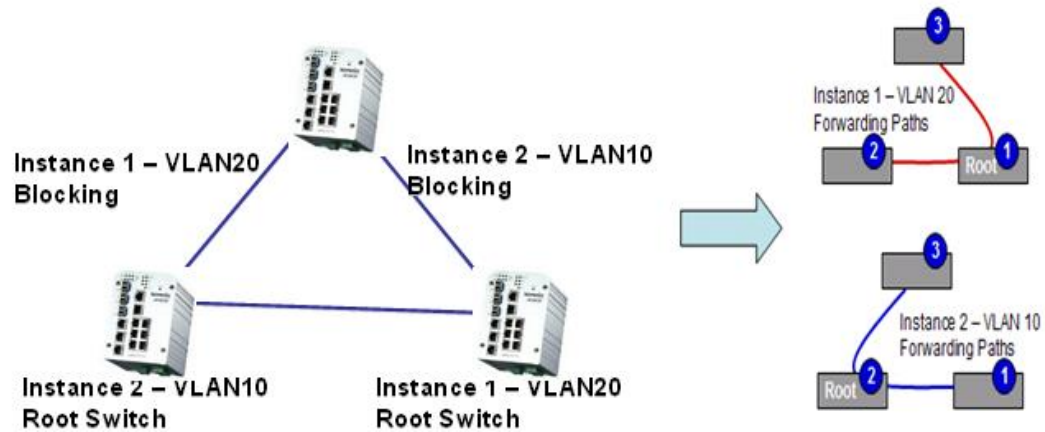

A Common Spanning Tree (CST) interconnects all adjacent MST regions and acts as a virtual bridge node for communications with STP or RSTP nodes in the global network. MSTP connects all bridges and LAN segments with a single Common and Internal Spanning Tree (CIST). The CIST is formed as a result of the running spanning tree algorithm between switches that support the STP, RSTP, MSTP protocols.

The figure shows the CST large network. In this network, a Region may have different instances and its own forwarding path and table, however, it acts as a single Bridge of CST.

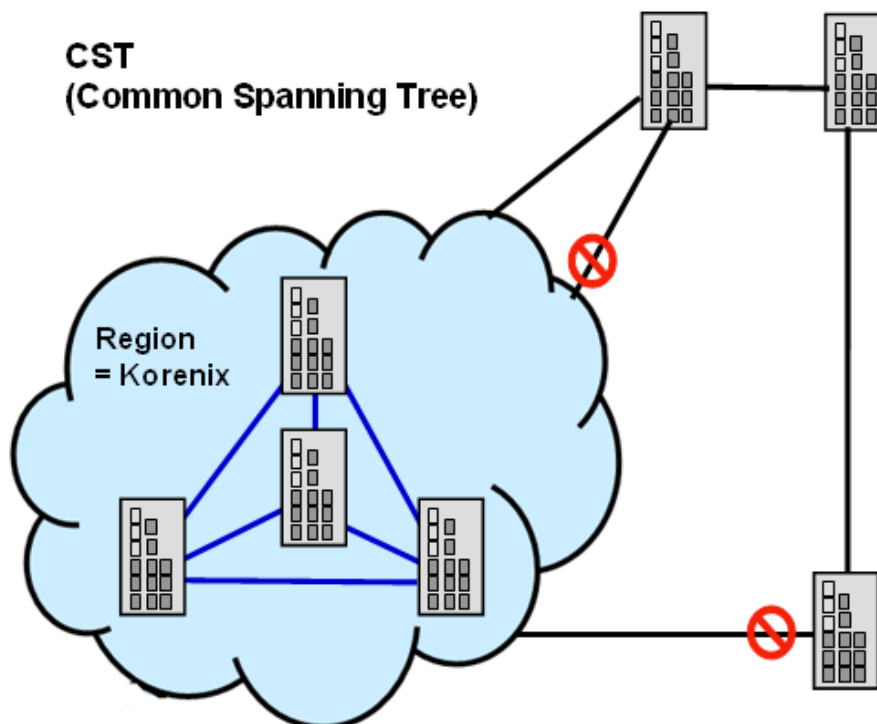

To configure the MSTP setting, the STP Mode of the STP Configuration page should be changed to MSTP mode first.

STP Configuration

STP Mode ▼

Bridge Configuration

Bridge Address	0012.7760.46b6
Bridge Priority	32768 ▼
Max Age	20 ▼
Hello Time	2 ▼
Forward Delay	15 ▼

After enabled MSTP mode, then you can go to the MSTP Configuration pages.

MSTP Region Configuration

This page allows configure the Region Name and its Revision, mapping the VLAN to Instance and check current MST Instance configuration. The network can be divided virtually to different Regions. The switches within the Region should have the same Region and Revision level.

Region Name: The name for the Region. Maximum length: 32 characters.

Revision: The revision for the Region. Range: 0-65535; Default: 0)

Once you finish your configuration, click on **Apply** to apply your settings.

New MST Instance

This page allows mapping the VLAN to Instance and assign priority to the instance. Before mapping VLAN to Instance, you should create VLAN and assign the member ports first. Please refer to the VLAN setting page.

MSTP Configuration

MST Region Configuration

Region Name	Korenix
Revision	0

Apply

New MST Instance

Instance ID	1
VLAN Group	
Instance Priority	32768

Add

Instance ID: Select the Instance ID, the available number is 1-15.

VLAN Group: Type the VLAN ID you want mapping to the instance.

Instance Priority: Assign the priority to the instance.

After finish your configuration, click on **Add** to apply your settings.

Current MST Instance Configuration

This page allows you to see the current MST Instance Configuration you added. Click on "**Apply**" to apply the setting. You can "**Remove**" the instance or "**Reload**" the configuration display in this page.

Current MST Instance Configuration

Instance ID	VLAN Group	Instance Priority
1	2	32768
2	3	32768

Apply

Remove

Reload

4.4.5 MSTP Port Configuration

This page allows configure the Port settings. Choose the Instance ID you want to configure. The MSTP enabled and linked up ports within the instance will be listed in this table.

Note that the ports not belonged to the Instance, or the ports not MSTP activated will not display. The meaning of the Path Cost, Priority, Link Type and Edge Port is the same as the definition of RSTP.

MSTP Port Configuration

Instance ID

Port	Path Cost	Priority	Link Type	Edge Port
1	200000	128	Auto	Enable
2	200000	128	Auto	Enable

Path Cost: Enter a number between 1 and 200,000,000. This value represents the “cost” of the path to the other bridge from the transmitting bridge at the specified port.

Priority: Enter a value between 0 and 240, using multiples of 16. This is the value that decides which port should be blocked by priority in a LAN.

Link Type: There are 3 types for you select. **Auto**, **P2P** and **Share**.

Some of the rapid state transitions that are possible within RSTP depend upon whether the port of concern can only be connected to another bridge (i.e. it is served by a point-to-point LAN segment), or if it can be connected to two or more bridges (i.e. it is served by a shared-medium LAN segment). This function allows link status of the link to be manipulated administratively. “**Auto**” means to auto select P2P or Share mode. “**P2P**” means P2P is enabled, the 2 ends work in Full duplex mode. While “**Share**” is enabled, it means P2P is disabled, the 2 ends may connect through a share media and work in Half duplex mode.

Edge: A port directly connected to the end stations cannot create a bridging loop in the network. To configure this port as an edge port, set the port to the **Enable** state. When the non-bridge device connects an admin edge port, this port will be in blocking state and turn to forwarding state in 4 seconds.

Once you finish your configuration, click on **Apply** to save your settings.

4.4.6 MSTP Information

This page allows you to see the current MSTP information.

Choose the **Instance ID** first. If the instance is not added, the information remains blank.

The **Root Information** shows the setting of the Root switch.

The **Port Information** shows the port setting and status of the ports within the instance.

MSTP Information

Instance ID

Root Information

Root Address	0012.7760.ad4b
Root Priority	4096
Root Port	N/A
Root Path Cost	0
Max Age	20 second(s)
Hello Time	2 second(s)
Forward Delay	15 second(s)

Port Information

Port	Role	Port State	Path Cost	Port Priority	Link Type	Edge Port
5	Designated	Forwarding	200000	128	P2P Internal(MSTP)	Non-Edge
6	Designated	Forwarding	200000	128	P2P Internal(MSTP)	Non-Edge

Click on “**Reload**” to reload the MSTP information display.

4.4.7 Multiple Super Ring (MSR)

The most common industrial network redundancy is to form a ring or loop. Typically, the managed switches are connected in series and the last switch is connected back to the first one. In such connection, you can implement Korenix Multiple Super Ring technology to get fastest recovery performance.

Multiple Super Ring (MSR) technology is *Korenix's* 3rd generation Ring redundancy technology. This is patented and protected by *Korenix* and is used in countries all over the world. MSR ranks the fastest restore and failover time in the world, 0 ms for restore and about milliseconds level for failover for 100Base-TX copper port. The other interface may take longer time due to the media characteristics.

Advanced **Rapid Dual Homing (RDH)** technology also facilitates *JetNet Managed Switch* to connect with a core managed switch easily and conveniently. With RDH technology, you can also couple several Rapid Super Rings or RSTP cloud together, which is also known as Auto Ring Coupling.

TrunkRing technology allows integrate MSR with LACP/Port Trunking. The LACP/Trunk aggregated ports is a virtual interface and it can work as the Ring port of the MSR.

MultiRing is an outstanding technology Korenix can support. Multiple rings can be aggregated within one switch by using different Ring ID. The maximum Ring number one switch can support is half of total port volume. For example, the *JetNet 6828Gf* is a 24 Fast Ethernet + 4 Gigabit port design, that means maximum 14 Rings (12 x 100M Rings and 2 Gigabit Rings) can be aggregated to one *JetNet 6828Gf*. The feature saves much effort when constructing complex network architecture.

To become backwards compatible with the Legacy Super Ring technology implemented in *JetNet 4008/4508 V1* series switches, *JetNet 4510/4518/5000 Series* also supports Super Ring Client mode. The Super Ring ports can pass through Super Ring control packets extremely well and works with Super Ring.

New Ring: To create a Rapid Super Ring. Just fill in the Ring ID which has range from 0 to 31. If the name field is left blank, the name of this ring will automatically naming with Ring ID.

New Ring

Ring ID	Name
1	

Ring Configuration

ID	Name	Version	Device Priority	Ring Port1	Path Cost	Ring Port2	Path Cost	Rapid Dual Homing	RDH Ext. ID	Ring Status

Ring Configuration

ID: Once a Ring is created, This appears and can not be changed.

Name: This field will show the name of the Ring. If it is not filled in when creating, it will be automatically named by the rule "RingID".

Version: The version of Ring can be changed here. There are two modes to choose: Rapid Super Ring and Super Chain, the Rapid Super Ring as default;

Device Priority: The switch with highest priority (highest value) will be automatically selected as Ring Master. Then one of the ring ports in this switch will become forwarding port and the other one will become blocking port. If all of the switches have the same priority, the switch with the biggest MAC address will be selected as Ring Master.

Ring Port1: In Rapid Super Ring environment, you should have 2 Ring Ports. No matter this switch is Ring Master or not, when configuring RSR, 2 ports should be selected to be Ring Ports. For Ring Master, one of the ring ports will become the forwarding port and the other one will become the blocking port.

Path Cost: Change the Path Cost of Ring Port1. If this switch is the Ring Master of a Ring, then it determines the blocking port. The Port with higher Path Cost in the two ring Port will become the blocking port, If the Path Cost is the same, the port with larger port number will become the blocking port.

Ring Port2: Assign another port for ring connection

Path Cost: Change the Path Cost of Ring Port2

Rapid Dual Homing: Rapid Dual Homing is an important feature of Korenix 3rd generation Ring redundancy technology. When you want to connect multiple RSR or form redundant topology with other vendors, RDH could allow you to have maximum 7 multiple links for redundancy without any problem.

RDH Ext. ID: Rapid Dual Homing Extension ID. The Extension ID and Ring ID cannot be

the same, when dual home to the same foreign network. The Extension ID range from 0 to 7. With the combination of Extension ID(0 to 7) and Ring ID(0 to 31), we can now support up to 256(8*32) different dual homing rings

In Dual Homing I released with JetNet 4000/4500 series, you have to configure additional port as Dual Homing port to two uplink switches. In Rapid Dual Homing, you don't need to configure specific port to connect to other protocol. The Rapid Dual Homing will smartly choose the fastest link for primary link and block all the other link to avoid loop. If the primary link failed, Rapid Dual Homing will automatically forward the secondary link for network redundant. Of course, if there are more connections, they will be standby links and recover one of them if both primary and secondary links are broken.

Ring status: To enable/disable the Ring. Please remember to enable the ring after you add it.

Super Chain Configuration

ID	Role	Edge Port

Apply

Super Chain Configuration

ID: The Ring Identifier referring to this Ring(Chain).

Role: Super Chain has two node role Border and Member. Border is the node which connect to foreign network. Member is the node except the Border node in the Super Chain.

Edge Port: Edge Port is one of ring ports of Border node. It is used to connect to foreign network.

MultiRing: The MultiRing technology is one of the pattern of the MSR technology, the technology allows you to aggregate multiple rings within one switch. Create multiple ring ID and assign different ring port 1 and port 2 to each ring, thus the switch can have multiple rings in one JetNet switch.

When implementing MultiRing, remember that the different rings can NOT use the same ring ID. The other settings are the same as above description. Technically, the maximum ring volume the MultiRing supported is up to 16 rings. Due to the port volume limitation, the maximum value is half of the port volume of a switch.

TrunkRing: The MultiRing technology is part of the MSR technology which combines the MSR with the port trunking technology. After multiple ports aggregated, this is so-call port trunking (Static or learnt by LACP protocol), the Trunk ID can be one of the port ID of the MSR technology. Configured the port trunking first then you can add the Trunk group as a Ring Port in managed switch.

4.4.8 Ring Info

This page shows the MSR information.

Multiple Super Ring Information

ID	Version	Role	Status	RM MAC	Blocking Port	Role Transition Count	Ring State Transition Count
1	Rapid Super Ring	RM	Normal	0012.7760.1455	fa2	2	4

Reload

ID: Ring ID.

Version: which version of this ring, this field could be Rapid Super Ring or Super Chain

Role: This Switch is RM or nonRM

Status: If this field is Normal which means the redundancy is approved. If any one of the link in this Ring is broken, then the status will be Abnormal.

RM MAC: The MAC address of Ring Master of this Ring. It helps to find the redundant path.

Blocking Port: This field shows which is blocked port of RM.

Role Transition Count: This means how many times this switch has changed its Role from nonRM to RM or from RM to nonRM.

Role state Transition Count: This number means how many times the Ring status has been transformed between Normal and Abnormal state.

4.4.9 ERPS Configuration:

Ethernet Ring Protection Switching, or ERPS, is an effort at ITU-T under G.8032 Recommendation to provide sub-50ms protection and recovery switching for Ethernet traffic in a ring topology and at the same time ensuring that there are no loops formed at the Ethernet layer.

Figure 4.4.9 Web UI of ERPS configuration

ERPS Configuration

ERPS ▼

ERPS Configuration

Version	v1
Node State	Disabled
Node Role	Ring Node ▼
Control Channel	1 ▼
Ring Port 1	Port 1 ▼
Ring Port 2	Port 2 ▼
RPL Port	Ring Port 2 ▼

ERPS: Enable or disable ERPS function.

ERPS Configuration:

Version: ERPS has version 1 and 2. Now we just support ERPSv1

Node State: The current state of the node, Idle and Protection.

Node Role: The role of the node, RPL owner and Ring node. The RPL owner is an Ethernet ring node adjacent to the RPL.

Control Channel: Control Channel provide a communication channel for ring automatic protection switching (R-APS) information.

Ring Port: A ring link is bounded by two adjacent nodes and a port for a ring link is called a ring port.

RPL Port: The ring protection link (RPL) is the ring link which under normal conditions, i.e., without any failure or request, is blocked for traffic channel, to prevent the formation of loops.

4.4.10 Command Lines:

Feature	Command Line
Global	
Enable	Switch(config)# spanning-tree enable
Disable	Switch (config)# spanning-tree disable
Mode (Choose the Spanning Tree mode)	Switch(config)# spanning-tree mode rst the rapid spanning-tree protocol (802.1w) stp the spanning-tree protocol (802.1d)

	mst the multiple spanning-tree protocol (802.1s)
Bridge Priority	Switch(config)# spanning-tree priority <0-61440> valid range is 0 to 61440 in multiple of 4096 Switch(config)# spanning-tree priority 4096
Bridge Times	Switch(config)# spanning-tree bridge-times (forward Delay) (max-age) (Hello Time) Switch(config)# spanning-tree bridge-times 15 20 2 This command allows you configure all the timing in one time.
Forward Delay	Switch(config)# spanning-tree forward-time <4-30> Valid range is 4~30 seconds Switch(config)# spanning-tree forward-time 15
Max Age	Switch(config)# spanning-tree max-age <6-40> Valid range is 6~40 seconds Switch(config)# spanning-tree max-age 20
Hello Time	Switch(config)# spanning-tree hello-time <1-10> Valid range is 1~10 seconds Switch(config)# spanning-tree hello-time 2
MSTP	
Enter the MSTP Configuration Tree	Switch(config)# spanning-tree mst MSTMAP the mst instance number or range configuration enter mst configuration mode forward-time the forward delay time hello-time the hello time max-age the message maximum age time max-hops the maximum hops sync sync port state of exist vlan entry Switch(config)# spanning-tree mst configuration Switch(config)# spanning-tree mst configuration Switch(config-mst)# abort exit current mode and discard all changes end exit current mode, change to enable mode and apply all changes exit exit current mode and apply all changes instance the mst instance list Print command list name the name of mst region no Negate a command or set its defaults quit exit current mode and apply all changes revision the revision of mst region show show mst configuration
Region Configuration	Region Name: Switch(config-mst)# name NAME the name string Switch(config-mst)# name korenix Region Revision: Switch(config-mst)# revision <0-65535> the value of revision Switch(config-mst)# revision 65535
Mapping Instance to VLAN (Ex: Mapping VLAN 2 to Instance 1)	Switch(config-mst)# instance <1-15> target instance number Switch(config-mst)# instance 1 vlan VLANMAP target vlan number(ex.10) or range(ex.1-10) Switch(config-mst)# instance 1 vlan 2
Display Current MST Configuration	Switch(config-mst)# show current Current MST configuration Name [korenix]

	<pre>Revision 65535 Instance Vlans Mapped ----- 0 1,4-4094 1 2 2 -- Config HMAC-MD5 Digest: 0xB41829F9030A054FB74EF7A8587FF58D -----</pre>
Remove Region Name	<pre>Switch(config-mst)# no name name configure revision revision configure instance the mst instance Switch(config-mst)# no name</pre>
Remove Instance example	<pre>Switch(config-mst)# no instance <1-15> target instance number Switch(config-mst)# no instance 2</pre>
Show Pending MST Configuration	<pre>Switch(config-mst)# show pending Pending MST configuration Name [] (->The name is removed by no name) Revision 65535 Instance Vlans Mapped ----- 0 1,3-4094 1 2 (->Instance 2 is removed by no instance -- Config HMAC-MD5 Digest: 0x3AB68794D602FDF43B21C0B37AC3BCA8 -----</pre>
Apply the setting and go to the configuration mode	<pre>Switch(config-mst)# quit apply all mst configuration changes Switch(config)#</pre>
Apply the setting and go to the global mode	<pre>Switch(config-mst)# end apply all mst configuration changes Switch#</pre>
<p>Abort the Setting and go to the configuration mode.</p> <p>Show Pending to see the new settings are not applied.</p>	<pre>Switch(config-mst)# abort discard all mst configuration changes Switch(config)# spanning-tree mst configuration Switch(config-mst)# show pending Pending MST configuration Name korenix (->The name is not applied after Abort settings.) Revision 65535 Instance Vlans Mapped ----- 0 1,4-4094 1 2 2 3 (-> The instance is not applied after Abort settings-- Config HMAC-MD5 Digest: 0xB41829F9030A054FB74EF7A8587FF58D -----</pre>
RSTP	
The mode should be rst, the timings can be configured in global settings listed in above.	
Global Information	
Active Information	<pre>Switch# show spanning-tree active Spanning-Tree : Enabled Protocol : MSTP Root Address : 0012.77ee.eeee Priority : 32768 Root Path Cost : 0 Root Port : N/A</pre>

	<p>Root Times : max-age 20, hello-time 2, forward-delay 15 Bridge Address : 0012.77ee.eeee Priority : 32768 Bridge Times : max-age 20, hello-time 2, forward-delay 15 BPDU transmission-limit : 3</p> <table border="1"> <thead> <tr> <th>Port</th> <th>Role</th> <th>State</th> <th>Cost</th> <th>Prio.Nbr</th> <th>Type</th> </tr> </thead> <tbody> <tr> <td colspan="6">Aggregated</td> </tr> <tr> <td>fa1</td> <td>Designated</td> <td>Forwarding</td> <td>200000</td> <td>128.1</td> <td>P2P(RSTP)</td> </tr> <tr> <td colspan="6">N/A</td> </tr> <tr> <td>fa2</td> <td>Designated</td> <td>Forwarding</td> <td>200000</td> <td>128.2</td> <td>P2P(RSTP)</td> </tr> <tr> <td colspan="6">N/A</td> </tr> </tbody> </table>	Port	Role	State	Cost	Prio.Nbr	Type	Aggregated						fa1	Designated	Forwarding	200000	128.1	P2P(RSTP)	N/A						fa2	Designated	Forwarding	200000	128.2	P2P(RSTP)	N/A					
Port	Role	State	Cost	Prio.Nbr	Type																																
Aggregated																																					
fa1	Designated	Forwarding	200000	128.1	P2P(RSTP)																																
N/A																																					
fa2	Designated	Forwarding	200000	128.2	P2P(RSTP)																																
N/A																																					
RSTP Summary	<p>Switch# show spanning-tree summary Switch is in rapid-stp mode. BPDU skewing detection disabled for the bridge. Backbone fast disabled for bridge. Summary of connected spanning tree ports : #Port-State Summary</p> <table border="1"> <thead> <tr> <th>Blocking</th> <th>Listening</th> <th>Learning</th> <th>Forwarding</th> <th>Disabled</th> </tr> </thead> <tbody> <tr> <td>0</td> <td>0</td> <td>0</td> <td>2</td> <td>8</td> </tr> </tbody> </table> <p>#Port Link-Type Summary</p> <table border="1"> <thead> <tr> <th>AutoDetected</th> <th>PointToPoint</th> <th>SharedLink</th> <th>EdgePort</th> </tr> </thead> <tbody> <tr> <td>9</td> <td>0</td> <td>1</td> <td>9</td> </tr> </tbody> </table>	Blocking	Listening	Learning	Forwarding	Disabled	0	0	0	2	8	AutoDetected	PointToPoint	SharedLink	EdgePort	9	0	1	9																		
Blocking	Listening	Learning	Forwarding	Disabled																																	
0	0	0	2	8																																	
AutoDetected	PointToPoint	SharedLink	EdgePort																																		
9	0	1	9																																		
Port Info	<p>Switch# show spanning-tree port detail fa7 (Interface_ID) Rapid Spanning-Tree feature Enabled Port 128.6 as Disabled Role is in Disabled State Port Path Cost 200000, Port Identifier 128.6 RSTP Port Admin Link-Type is Auto, Oper Link-Type is Point-to-Point RSTP Port Admin Edge-Port is Enabled, Oper Edge-Port is Edge Designated root has priority 32768, address 0012.7700.0112 Designated bridge has priority 32768, address 0012.7760.1aec Designated Port ID is 128.6, Root Path Cost is 600000 Timers : message-age 0 sec, forward-delay 0 sec</p> <p>Link Aggregation Group: N/A, Type: N/A, Aggregated with: N/A</p> <p>BPDU: sent 43759 , received 4854 TCN : sent 0 , received 0 Forwarding-State Transmit count 12 Message-Age Expired count</p>																																				
MSTP Information-																																					
MSTP Configuraiton-	<p>Switch# show spanning-tree mst configuration Current MST configuration (MSTP is Running)</p> <table border="1"> <thead> <tr> <th>Name</th> <th>Revision</th> <th>Instance</th> <th>Vlans Mapped</th> </tr> </thead> <tbody> <tr> <td>korenix</td> <td>65535</td> <td>0</td> <td>1,4-4094</td> </tr> <tr> <td></td> <td></td> <td>1</td> <td>2</td> </tr> <tr> <td></td> <td></td> <td>2</td> <td>--</td> </tr> </tbody> </table> <p>Config HMAC-MD5 Digest: 0xB41829F9030A054FB74EF7A8587FF58D</p>	Name	Revision	Instance	Vlans Mapped	korenix	65535	0	1,4-4094			1	2			2	--																				
Name	Revision	Instance	Vlans Mapped																																		
korenix	65535	0	1,4-4094																																		
		1	2																																		
		2	--																																		
Display all MST	Switch# show spanning-tree mst																																				

Information	<pre>##### MST00 vlans mapped: 1,4-4094 Bridge address 0012.77ee.eeee priority 32768 (sysid 0) Root this switch for CST and IST Configured max-age 2, hello-time 15, forward-delay 20, max-hops 20 Port Role State Cost Prio.Nbr Type ----- fa1 Designated Forwarding 200000 128.1 P2P Internal(MSTP) fa2 Designated Forwarding 200000 128.2 P2P Internal(MSTP) ##### MST01 vlans mapped: 2 Bridge address 0012.77ee.eeee priority 32768 (sysid 1) Root this switch for MST01 Port Role State Cost Prio.Nbr Type ----- fa1 Designated Forwarding 200000 128.1 P2P Internal(MSTP) fa2 Designated Forwarding 200000 128.2 P2P Internal(MSTP)</pre>
MSTP Root Information	<pre>Switch# show spanning-tree mst root MST Root Root Root Root Max Hello Fwd Instance Address Priority Cost Port age dly ----- MST00 0012.77ee.eeee 32768 0 N/A 20 2 15 MST01 0012.77ee.eeee 32768 0 N/A 20 2 15 MST02 0012.77ee.eeee 32768 0 N/A 20 2 15</pre>
MSTP Instance Information	<pre>Switch# show spanning-tree mst 1 ##### MST01 vlans mapped: 2 Bridge address 0012.77ee.eeee priority 32768 (sysid 1) Root this switch for MST01 Port Role State Cost Prio.Nbr Type ----- fa1 Designated Forwarding 200000 128.1 P2P Internal(MSTP) fa2 Designated Forwarding 200000 128.2 P2P Internal(MSTP)</pre>
MSTP Port Information	<pre>Switch# show spanning-tree mst interface fa1 Interface fastethernet1 of MST00 is Designated Forwarding Edge Port : Edge (Edge) BPDU Filter : Disabled Link Type : Auto (Point-to-point) BPDU Guard : Disabled Boundary : Internal(MSTP) BPDUs : sent 6352, received 0 Instance Role State Cost Prio.Nbr Vlans mapped ----- 0 Designated Forwarding 200000 128.1 1,4-4094 1 Designated Forwarding 200000 128.1 2 2 Designated Forwarding 200000 128.1 3</pre>
Multiple Super Ring	

Create or configure a Ring	Switch(config)# multiple-super-ring 1 Ring 1 created Switch(config-multiple-super-ring)# Note: 1 is the target Ring ID which is going to be created or configured.
Delete a Ring	Switch(config-multiple-super-ring)# delete Ring 1 delete. Switch(config)# Note: It will exit from multiple-super-ring configuration mode after delete this ring.
Enable a Ring	Switch(config-multiple-super-ring)# start Start Multiple Super Ring success
Disable a Ring	Switch(config-multiple-super-ring)# stop Stop Multiple Super Ring success.
Change Ring name	Switch(config-multiple-super-ring)# name MSR1 Note: Default Ring name is "Ring1", 1 is the Ring ID.
Super Ring Version	Switch(config-multiple-super-ring)# version default set default to rapid super ring rapid-super-ring rapid super ring Switch(config-multiple-super-ring)# version rapid-super-ring
Priority	Switch(config-multiple-super-ring)# priority <0-255> valid range is 0 to 255 default set default Switch(config)# super-ring priority 100
Ring Port	Switch(config-multiple-super-ring)# port IFLIST Interface list, ex: fa1,fa3-5,gi8-10 cost path cost Switch(config-multiple-super-ring)# port fa1,fa2
Ring Port Cost	Switch(config-multiple-super-ring)# port cost <0-255> valid range is 0 or 255 default set default (128)valid range is 0 or 255 Switch(config-multiple-super-ring)# port cost 100 <0-255> valid range is 0 or 255 default set default (128)valid range is 0 or 255 Switch(config-super-ring-plus)# port cost 100 200 Set path cost success.
Rapid Dual Homing	Switch(config-multiple-super-ring)# rapid-dual-homing enable Switch(config-multiple-super-ring)# rapid-dual-homing disable Switch(config-multiple-super-ring)# rapid-dual-homing port IFLIST Interface name, ex: fastethernet1 or gi8 auto-detect up link auto detection IFNAME Interface name, ex: fastethernet1 or gi8 Switch(config-multiple-super-ring)# rapid-dual-homing port fa3,fa5-6 set Rapid Dual Homing port success. Switch(config-multiple-super-ring)#rapid-dual-homing extension <0-7> extension ID 0-7 (default is 0) default Note: auto-detect is recommended for dual Homing..
Super Chain	Switch(config-multiple-super-ring)# super-chain disable Switch(config-multiple-super-ring)# super-chain border Switch(config-multiple-super-ring)# super-chain member Switch(config-multiple-super-ring)# super-chain edge-port PLIST Port
Ring Info	
Ring Info	Switch# show multiple-super-ring [Ring ID]

	<pre> [Ring1] Ring1 Current Status : Disabled Role : Disabled Ring Status : Abnormal Ring Manager : 0000.0000.0000 Blocking Port : N/A Giga Copper : N/A Configuration : Version : Rapid Super Ring Priority : 128 Ring Port : fa1, fa2 Path Cost : 128, 128 Rapid Dual Homing : Disabled Extension ID : 0 Up Link : Auto Detect (N/A) Super Chain : Disabled Chain Role : N/A Chain Edge Port : N/A Statistics : Watchdog sent 0, received 0, missed 0 Link Up sent 0, received 0 Link Down sent 0, received 0 Role Transition count 0 Ring State Transition count 1 Ring ID is optional. If the ring ID is typed, this command will only display the information of the target Ring. </pre>
ERPS	
show erps	<pre> Switch# show erps Ethernet Ring Protection Switching (ITU-T G.8032) Version : v1 Ring State : Disabled Node State : Disabled Node Role : Ring Node Control Channel : VLAN 1 Ring Port 1 : fa1 is Link Down and Blocking Ring Port 2 : fa2 is Link Down and Blocking RPL Port : Ring Port 2 Timers WTR Timer : period is 1 minutes, timer is not running, remains 0 ms Guard Timer : period is 100 ms, timer is not running, remains 0 ms Statistics R-APS(SF) : sent 0, received 0 R-APS(NR,RB) : sent 0, received 0 R-APS(NR) : sent 0, received 0 Node State Transition count 0 Switch# </pre>
Configure ERPS	<pre> Switch(config)# erps enable Start the Multiple Super Ring for the switch disable Stop the Multiple Super Ring for the switch version the protocol version node-role The node role of ERPS node ring-port The ring port1 and port2 of the ERPS rpl The ring Ring Protection Link of the ERPS </pre>

	<pre> control-channel timer The ring control channel of the ERPS The period of timer Switch(config)# erps en enable Start the Multiple Super Ring for the switch Switch(config)# erps version 1 version 1 default Set default to version 1 Switch(config)# erps version 1 version 1 default Set default to version 1 Switch(config)# erps node-role rpl-owner ERPS RPL Owner ring-node ERPS ring node Switch(config)# erps ring-port PORT1 The ring port 1 Switch(config)# erps rpl ring-port Assign ring port as RPL Switch(config)# erps control-channel <1-4095> The VLAN ID of control channel, valid range is from 1 to 4094 Switch(config)# erps timer wtr-timer WTR(Wait-to-restore) Timer guard-timer Guard Timer </pre>
--	---

4.5 VLAN

A Virtual LAN (VLAN) is a “logical” grouping of nodes for the purpose of limiting a broadcast domain to specific members of a group without physically grouping the members together. That means, VLAN allows you to isolate network traffic so that only members of VLAN could receive traffic from the same VLAN members. Basically, creating a VLAN from a switch is the logical equivalent of physically reconnecting a group of network devices to another Layer 2 switch, without actually disconnecting these devices from their original switches.

JetNet 6828Gf Series Industrial Ethernet Switch supports 802.1Q VLAN. 802.1Q VLAN is also known as Tag-Based VLAN. This Tag-Based VLAN allows VLAN to be created across different switches (see Figure 1). IEEE 802.1Q tag-based VLAN makes use of VLAN control information stored in a VLAN header attached to IEEE 802.3 packet frames. This tag contains a VLAN Identifier (VID) that indicates which VLAN a frame belongs to. Since each switch only has to check a frame’s tag, without the need to dissect the contents of the frame, this also saves a lot of computing resources within the switch.

Figure 4.5.1 802.1Q VLAN

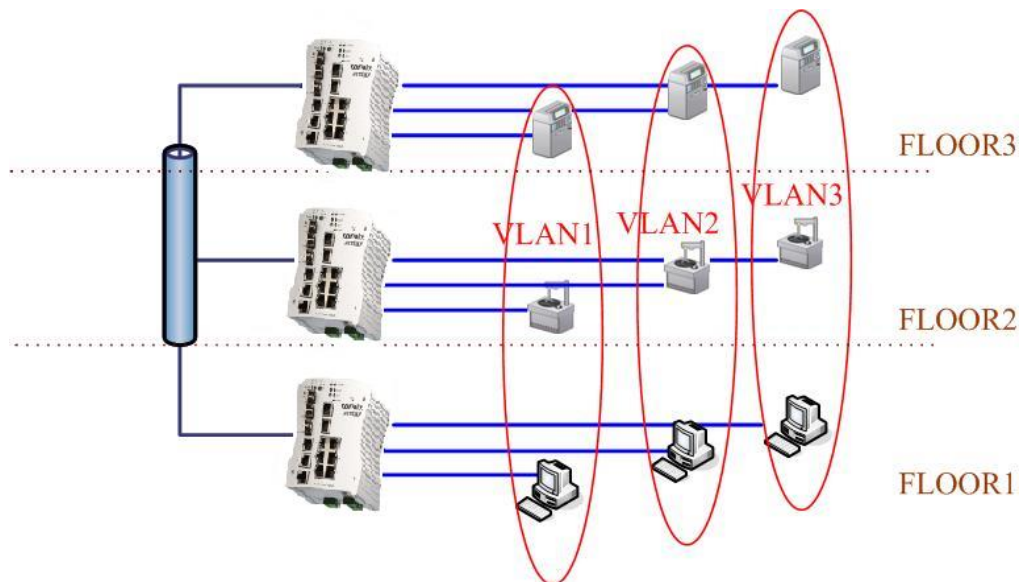

QinQ

The QinQ is originally designed to expand the number of VLANs by adding a tag to the 802.1Q packets. The original VLAN is usually identified as Customer VLAN (C-VLAN) and the new added tag - as Service VLAN(S-VLAN). By adding the additional tag, QinQ increases the possible number of VLANs. After QinQ enabled, the JetNet can reach up to 256x256 VLANs. With different standard tags, it also improves the network security.

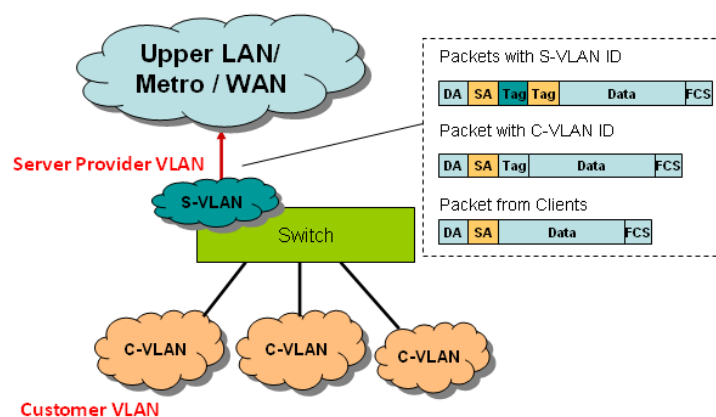

VLAN Configuration group enables you to Add/Remove VLAN, configure QinQ, port Ingress/Egress parameters and view VLAN table.

VLAN Configuration group enables you to Add/Remove VLAN, configure port Ingress/Egress parameters and view VLAN table.

Following commands are included in this group:

- 4.5.1 VLAN Port Configuration
- 4.5.2 VLAN Configuration
- 4.5.3 GVRP Configuration
- 4.5.4 VLAN Table
- 4.5.5 CLI Commands of the VLAN

4.5.1 VLAN Port Configuration

VLAN Port Configuration allows you to set up VLAN port parameters to specific port. These parameters include PVID, Accept Frame Type and Ingress Filtering.

VLAN Port Configuration

VLAN Port Configuration

Port	PVID	Tunnel Mode	EtherType	Accept Frame Type	Ingress Filtering
1	1	None	0x8100	Admit All	Disable
2	1	None	0x8100	Admit All	Disable
3	2	None	0x8100	Admit All	Disable
4	1	None	0x8100	Admit All	Disable
5	1	None	0x8100	Admit All	Disable
6	1	None	0x8100	Admit All	Disable
7	1	None	0x8100	Admit All	Disable
8	1	None	0x8100	Admit All	Disable
9	2	None	0x8100	Admit All	Disable
10	1	None	0x8100	Admit All	Disable

Apply

Figure 4.5.2 Web UI of VLAN configuration.

PVID: The abbreviation of the **Port VLAN ID**. Enter port VLAN ID here. PVID allows the switches to identify which port belongs to which VLAN. To keep things simple, it is recommended that PVID is equivalent to VLAN IDs.

The values of PVIDs are from 0 to 4095. But, 0 and 4095 are reserved. You can't input these 2 PVIDs. 1 is the default value. 2 to 4094 are valid and available in this column. Type the PVID you'd like to configure here.

Tunnel Mode: This is the new command for QinQ. The command includes None, 802.1Q Tunnel and 802.1Q Tunnel Uplink. The figure shows the relationship between 802.1Q Tunnel and 802.1Q Tunnel Uplink.

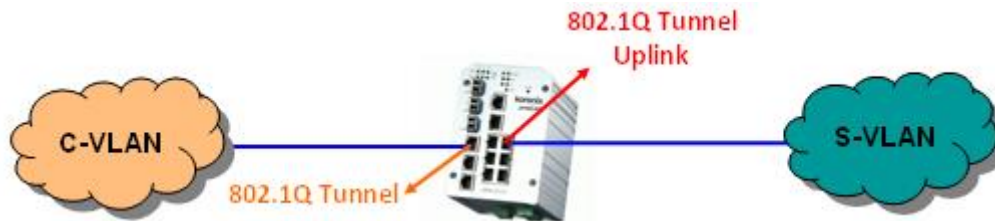

Following is the modes you can select.

None: Remain VLAN setting, no QinQ.

802.1Q Tunnel: The QinQ command applied to the ports which connect to the C-VLAN. The port receives tagged frame from the C-VLAN. Add a new tag (Port VID) as S-VLAN VID. When the packets are forwarded to C-VLAN, the S-VLAN tag is removed.

After 802.1Q Tunnel mode is assigned to a port, the egress setting of the port should be “**Untag**”, it indicates the egress packet is always untagged. This is configured in Static VLAN Configuration table. Please refer to the VLAN Configuration chapter in below.

802.1Q Tunnel Uplink: The QinQ command applied to the ports which connect to the S-VLAN. The port receives tagged frame from the S-VLAN. When the packets are forwarded to S-VLAN, the S-VLAN tag is kept.

After 802.1Q Tunnel Uplink mode is assigned to a port, the egress setting of the port should be “**Tag**”, it indicates the egress packet is always tagged. This is configured in Static VLAN Configuration table. Please refer to the VLAN Configuration chapter in below.

For example, the VID of S-VLAN/Tunnel Uplink is 10, the VID of C-VLAN/Tunnel is 5. The 802.1Q Tunnel port receives tag 5 from C-VLAN, add tag 10 to the packet. When the packets are forwarded to S-VLAN, tag 10 is kept.

EtherType: This column allows you to define the EtherType manually. This is advanced QinQ parameter which allows to define the transmission packet type.

Accept Frame Type: This column defines the accepted frame type of the port. There are 2 modes you can select, **Admit All** and **Tag Only**. Admit All mode means that the port can accept both tagged and untagged packets. Tag Only mode means that the port can only accept tagged packets.

Ingress Filtering: Ingress filtering helps VLAN engine to filter out undesired traffic on a port. When Ingress Filtering is enabled, the port checks whether the incoming frames belong to the VLAN they claimed or not. Then the port determines if the frames can be processed or not. For example, if a tagged frame from Engineer VLAN is received, and Ingress Filtering is enabled, the switch will determine if the port is on the Engineer VLAN's Egress list. If it is, the frame can be processed. If it's not, the frame would be dropped.

4.5.2 VLAN Configuration

In this page, you can assign Management VLAN, create the static VLAN, and assign the Egress rule for the member ports of the VLAN.

Figure 4.5.2.1 Web UI of the VLAN Configuration.

VLAN Configuration

Management VLAN ID

Apply

Static VLAN

VLAN ID	Name
<input type="text"/>	<input type="text"/>

Add

Static VLAN Configuration

VLAN ID	Name	1	2	3	4	5	6	7	8	9	10	11	12	13	14	15	16	17	18	19	
1	VLAN1	U	U	U	U	U	U	U	U	U	U	U	U	U	U	U	U	U	U	U	U

Apply

Remove

Reload

Management VLAN ID: The switch supports management VLAN. The management VLAN ID is the VLAN ID of the CPU interface so that **only member ports of the management VLAN can ping and access the switch**. The default management VLAN ID is 1.

Static VLAN: You can assign a VLAN ID and VLAN Name for new VLAN here.

VLAN ID is used by the switch to identify different VLANs. Valid VLAN ID is between 1 and 4094. 1 is the default VLAN.

VLAN Name is a reference for network administrator to identify different VLANs. The available character is 12 for you to input. If you don't input VLAN name, the system will automatically assign VLAN name for the VLAN. The rule is VLAN (VLAN ID).

Static VLAN

VLAN ID	NAME
<input type="text" value="3"/>	<input type="text" value="test"/>

Add

Help

Figure 4.5.2.2 The steps to create a new VLAN: Type VLAN ID and NAME, and press **Add** to create a new VLAN. Then you can see the new VLAN in the Static VLAN Configuration table. Refer to Figure 4.5.2.3

After created the VLAN, the status of the VLAN will remain in Unused until you add ports to the VLAN.

Note: Before you change the management VLAN ID by Web and Telnet, remember that the port attached by the administrator should be the member port of the management VLAN; otherwise the administrator can't access the switch via the network.

Note: Currently JetNet 6828Gf supports max 256 group VLAN.

Static VLAN Configuration

You can see the created VLANs and specify the egress (outgoing) port rule to be **Untagged or Tagged** here.

Figure 4.5.2.3 Static VLAN Configuration table. You can see that new VLAN 3 is created. VLAN name is test. Egress rules of the ports are not configured now.

Static VLAN Configuration

VLAN ID	Name	1	2	3	4	5	6	7	8	9	10	11	12	13	14	15	16	17	18	19	
1	VLAN1	U	U	U	U	U	U	U	U	U	U	U	U	U	U	U	U	U	U	U	U
2	V2	--	--	--	--	--	--	--	--	--	--	--	--	--	--	--	--	--	--	--	--
3	test	--	--	--	--	--	--	--	--	--	--	--	--	--	--	--	--	--	--	--	--

Apply Remove Reload

Figure 4.5.2.4 Configure Egress rule of the ports.

Static VLAN Configuration

VLAN ID	Name	1	2	3	4	5	6	7	8	9	10	11	12	13	14	15	16	17	18	19	
1	VLAN1	U	U	U	U	U	U	U	U	U	U	U	U	U	U	U	U	U	U	U	U
2	V2	--	--	--	--	--	--	--	--	--	--	--	--	--	--	--	--	--	--	--	--
3	test	--	--	--	--	--	--	--	--	U	U	U	T	T	T	--	--	--	--	--	--

Apply Remove Reload

-- : Not available

U: Untag: Indicates that egress/outgoing frames are not VLAN tagged.

T : Tag: Indicates that egress/outgoing frames are to be VLAN tagged.

Steps to configure Egress rules: Select the VLAN ID. Entry of the selected VLAN turns to light blue. Assign Egress rule of the ports to **U** or **T**. Press **Apply** to apply the setting. If you want to remove one VLAN, select the VLAN entry. Then press **Remove** button.

4.5.3 GVRP configuration

GVRP allows users to set-up VLANs automatically rather than manual configuration on every port of every switch in the network. In low volume and stable network, the GVRP can reduce the configuration effort. For high volume and high secure request network, the Static VLAN configuration is always preferred.

GVRP Configuration

GVRP Protocol

Port	State	Join Timer	Leave Timer	Leave All Timer
1	Disable	20	60	1000
2	Disable	20	60	1000
3	Disable	20	60	1000
4	Disable	20	60	1000
5	Disable	20	60	1000
6	Disable	20	60	1000
7	Disable	20	60	1000
8	Disable	20	60	1000
9	Disable	20	60	1000
10	Disable	20	60	1000

Note: Timer unit is centiseconds.

GVRP Protocol: Allow user to enable/disable GVRP globally.

State: After enable GVRP globally, here still can enable/disable GVRP by port.

Join Timer: Controls the interval of sending the GVRP Join BPDU. An instance of this timer is required on a per-Port, per-GARP Participant basis

Leave Timer: Control the time to release the GVRP reservation after received the GVRP Leave BPDU. An instance of the timer is required for each state machine that is in the LV state

Leave All Timer: Controls the period to initiate the garbage collection of registered VLAN. The timer is required on a per-Port, per-GARP Participant basis

4.5.4 VLAN Table

This table shows you current settings of your VLAN table, including VLAN ID, Name, Status, and Egress rule of the ports.

VLAN ID: ID of the VLAN.

Name: Name of the VLAN.

Status: **Static** shows this is a manually configured static VLAN. **Unused** means this VLAN is created by UI/CLI and has no member ports. This VLAN is not workable yet. **Dynamic** means this VLAN is learnt by GVRP.

After created the VLAN, the status of this VLAN will remain in Unused status until you add ports to the VLAN.

VLAN Table

VLAN Table

VLAN ID	Name	Status	1	2	3	4	5	6	7	8	9	10	11	12	13	14	15	16
1	VLAN1	Static	U	U	U	U	U	U	U	U	U	U	U	U	U	U	U	U
2	V2	Unused	--	--	--	--	--	--	--	--	--	--	--	--	--	--	--	--
3	test	Static	--	--	--	--	--	--	--	--	U	U	U	T	T	T	--	--

Reload

4.5.5 CLI Commands of the VLAN

Command Lines of the VLAN port configuration, VLAN configuration and VLAN table display

Feature	Command Line
VLAN Port Configuration	
Port Interface Configuration	Switch# conf ter Switch(config)# interface gi5 Switch(config-if)#
VLAN Port PVID	Switch(config-if)# switchport trunk native vlan 2 Set port default vlan id to 2 success
QinQ Tunnel Mode 802.1Q Tunnel = access 802.1Q Tunnel Uplink = uplink	Switch(config-if)# switchport dot1q-tunnel mode Set the interface as an IEEE 802.1Q tunnel mode Switch(config-if)# switchport dot1q-tunnel mode access Set the interface as an access port of IEEE 802.1Q tunnel mode uplink Set the interface as an uplink port of IEEE 802.1Q tunnel mode
Port Accept Frame Type	Switch(config)# inter gi1 Switch(config-if)# acceptable frame type all any kind of frame type is accepted! Switch(config-if)# acceptable frame type vlantaggedonly only vlan-tag frame is accepted!
Egress rule – Untagged (for VLAN 2)	Switch(config-if)# switchport access vlan 2 switchport access vlan add success
Egress rule – Tagged (for VLAN 2)	Switch(config-if)# switchport trunk allowed vlan add 2

<p>Display – Port Ingress Rule (PVID, Ingress Filtering, Acceptable Frame Type)</p>	<pre>Switch# show interface gi1 Interface gigabitethernet1 Description : N/A Administrative Status : Enable Operating Status : Not Connected Duplex : Auto Speed : Auto MTU : 1518 Flow Control :off Default Port VLAN ID: 2 Acceptable Frame Type : Vlan Tagged Only Auto Negotiation : Enable Loopback Mode : None STP Status: disabled Default CoS Value for untagged packets is 0. Medium mode is Copper.</pre>
<p>Display – Port Egress Rule (Egress rule, IP address, status)</p>	<pre>Switch# show running-config ! interface gigabitethernet1 acceptable frame type vlantaggedonly switchport access vlan 1 switchport access vlan 3 switchport trunk native vlan 2 interface vlan1 ip address 192.168.10.8/24 no shutdown</pre>
<p>QinQ Information – 802.1Q Tunnel</p>	<pre>Switch# show dot1q-tunnel Port Mode Ethertype ----- 1 normal 0x8100 2 normal 0x8100 3 normal 0x8100 4 normal 0x8100 5 access 0x8100 6 uplink 0x8100 7 normal 0x8100 8 normal 0x8100 9 normal 0x8100 10 normal 0x8100</pre>
<p>QinQ Information – Show Running</p>	<pre>Switch# show running-config Building configuration... Current configuration: hostname Switch vlan learning independent interface gigabitethernet5 switchport access vlan add 1-2,10 switchport dot1q-tunnel mode access ! interface gigabitethernet6 switchport access vlan add 1-2</pre>

	<pre>switchport trunk allowed vlan add 10 switchport dot1q-tunnel mode uplink !</pre>
VLAN Configuration	
Create VLAN (2)	<pre>Switch(config)# vlan 2 vlan 2 success Switch(config)# interface vlan 2 Switch(config-if)#</pre> <p><i>Note: In CLI configuration, you should create a VLAN interface first. Then you can start to add/remove ports. Default status of the created VLAN is unused until you add member ports to it.</i></p>
Remove VLAN	<pre>Switch(config)# no vlan 2 no vlan success</pre> <p><i>Note: You can only remove the VLAN when the VLAN is in unused mode.</i></p>
VLAN Name	<pre>Switch(config)# vlan 2 vlan 2 has exists Switch(config-vlan)# name v2 Switch(config-vlan)# no name</pre> <p><i>Note: Use no name to change the name to default name, VLAN VID.</i></p>
VLAN description	<pre>Switch(config)# interface vlan 2 Switch(config-if)# Switch(config-if)# description this is the VLAN 2 Switch(config-if)# no description ->Delete the description.</pre>
IP address of the VLAN	<pre>Switch(config)# interface vlan 2 Switch(config-if)# Switch(config-if)# ip address 192.168.10.18/24 Switch(config-if)# no ip address 192.168.10.8/24 ->Delete the IP address</pre>
Shut down VLAN	<pre>Switch(config)# interface vlan 2 Switch(config-if)# shutdown Switch(config-if)# no shutdown ->Turn on the VLAN</pre>
Display – VLAN table	<pre>Switch# sh vlan VLAN Name Status Trunk Ports Access Ports ---- - ----- 1 VLAN1 Static - gi1-7,gi8-10 2 VLAN2 Unused - - 3 test Static gi4-7,gi8-10 gi1-3,gi7,gi8-10</pre>
Display – VLAN interface information	<pre>Switch# show interface vlan1 Interface vlan1 Description : N/A Administrative Status : Enable Operating Status : Up DHCP Client : Disable Primary IP Address : 192.168.10.1/24</pre>

	IPv6 Address : fe80::212:77ff:feff:2222/64
GVRP configuration	
GVRP enable/disable	Switch(config)# gvrp mode disable Disable GVRP feature globally on the switch enable Enable GVRP feature globally on the switch Switch(config)# gvrp mode enable Gvrp is enabled on the switch!
Configure GVRP timer Join timer /Leave timer/ LeaveAll timer	Switch(config)# inter gi1 Switch(config-if)# garp join-timer <10-10000> the timer values Switch(config-if)# garp join-timer 20 Garp join timer value is set to 20 centiseconds on port 1!
Management VLAN	
Management VLAN	Switch(config)# int vlan 1 (Go to management VLAN) Switch(config-if)# no shutdown
Display	Switch# show running-config ! interface vlan1 ip address 192.168.10.17/24 ip igmp no shutdown !

4.6 Private VLAN

The private VLAN helps to resolve the primary VLAN ID shortage, client ports' isolation and network security issues. The Private VLAN provides primary and secondary VLAN within a single switch.

Primary VLAN: The uplink port is usually the primary VLAN. A primary VLAN contains promiscuous ports that can communicate with lower Secondary VLANs.

Secondary VLAN: The client ports are usually defined within secondary VLAN. The secondary VLAN includes Isolated VLAN and Community VLAN. The client ports can be isolated VLANs or can be grouped in the same Community VLAN. The ports within the same community VLAN can communicate with each other. However, the isolated VLAN ports can Not.

The figure shows the typical Private VLAN network. The SCADA/Public Server or NMS workstation is usually located in primary VLAN. The clients PCs or Rings are located within Secondary.

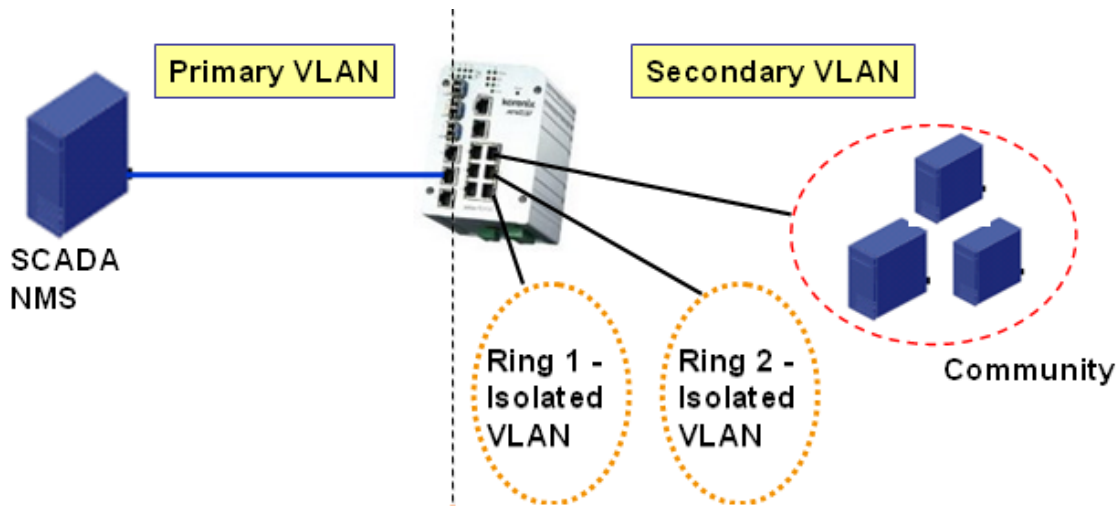

Private VLAN (PVLAN) Configuration group enables you to Configure PVLAN, PVLAN Port and see the PVLAN Information.

Following commands are included in this group:

- 4.6.1 PVLAN Configuration
- 4.6.2 PVLAN Port Configuration
- 4.6.3 PVLAN Informtion
- 4.6.4 CLI Commands of the PVLAN

4.6.1 PVLAN Configuration

PVLAN Configuration allows you to assign Private VLAN type. After created VLAN in VLAN Configuration page, the available VLAN ID will display here. Choose the Private VLAN types for each VLAN you want configure.

None: The VLAN is Not included in Private VLAN.

Primary: The VLAN is the Primary VLAN. The member ports can communicate with secondary ports.

Isolated: The VLAN is the Isolated VLAN. The member ports of the VLAN are isolated.

Community: The VLAN is the Community VLAN. The member ports of the VLAN can

Private VLAN Configuration

Private VLAN Configuration

VLAN ID	Private VLAN Type
2	Primary
3	Isolated
4	Community
5	Isolated

None
Primary
Isolated
Community

communicate with each other.

4.6.2 PVLAN Port Configuration

PVLAN Port Configuration page allows configure Port Configuration and Private VLAN Association.

Private VLAN Association

Secondary VLAN: After the Isolated and Community VLAN Type is assigned in Private VLAN Configuration page, the VLANs are belonged to the Secondary VLAN and displayed here.

Primary VLAN: After the Primary VLAN Type is assigned in Private VLAN Configuration page, the secondary VLAN can associate to the Primary VLAN ID. Select the Primary VLAN ID here.

Note: Before configuring PVLAN port type, the Private VLAN Association should be done first.

Port Configuraion

PVLAN Port Type :

Normal: The Normal port is None PVLAN ports, it remains its original VLAN setting.

Host: The Host type ports can be mapped to the Secondary VLAN.

Promiscuous: The promiscuous port can be associated to the Primary VLAN.

VLAN ID: After assigned the port type, the web UI display the available VLAN ID the port can associate to.

For example:

1. VLAN Create: VLAN 2-5 are created in VLAN Configuration page.

2. Private VLAN Type: VLAN 2-5 has its Private VLAN Type configured in Private VLAN Configuration page.

VLAN 2 is belonged to Primary VLAN.

VLAN 3-5 are belonged to secondary VLAN (Isolated or Community).

3. Private VLAN Association: Associate VLAN 3-5 to VLAN 2 in Private VLAN Association first.

4. Private VLAN Port Configuration:

VLAN 2 – Primary -> The member port of VLAN 2 is promiscuous port.

VLAN 3 – Isolated -> The Host port can be mapped to VLAN 3.

VLAN 4 – Community -> The Host port can be mapped to VLAN 4.

VLAN 5 – Community -> The Host port can be mapped to VLAN 5.

5. Result:

VLAN 2 -> VLAN 3, 4, 5; member ports can communicate with ports in secondary VLAN.

VLAN 3 -> VLAN 2, member ports are isolated, but it can communicate with member port of VLAN 2..

VLAN 4 -> VLAN 2, member ports within the community can communicate with each other and communicate with member port of VLAN 2.

VLAN 5 -> VLAN 2, member ports within the community can communicate with each other and communicate with member port of VLAN 2.

Private VLAN Port Configuration

Port Configuration

Port	PVLAN Port Type	VLAN ID
1	Normal	None
2	Normal	None
3	Normal	None
4	Normal	None
5	Normal	None
6	Normal	None
7	Host	5
8	Host	4
9	Host	3
10	Promiscuous	2

Apply

Private VLAN Association

Secondary VLAN	Primary VLAN
3	2
4	2
5	2

4.6.3 PVLAN Information

This page allows you to see the Private VLAN information.

Private VLAN Information

Private VLAN Information

Primary VLAN	Secondary VLAN	Secondary VLAN Type	Ports
2	3	Isolated	10,9
2	4	Community	10,8
2	5	Community	10,7

Reload

4.6.4 CLI Command of the PVLAN

Command Lines of the Private VLAN configuration

Feature	Command Line
Private VLAN Configuration	
Create VLAN	Switch(config)# vlan 2 vlan 2 success Switch(config-vlan)# end End current mode and change to enable mode exit Exit current mode and down to previous mode list Print command list name Assign a name to vlan no no private-vlan Configure a private VLAN
Private VLAN Type	Go to the VLAN you want configure first. Switch(config)# vlan (VID)
Choose the Types	Switch(config-vlan)# private-vlan community Configure the VLAN as an community private VLAN isolated Configure the VLAN as an isolated private VLAN

Primary Type	primary Configure the VLAN as a primary private VLAN Switch(config-vlan)# private-vlan primary Switch(config-vlan)# no private-vlan primary <cr>
Isolated Type	Switch(config-vlan)# private-vlan isolated Switch(config-vlan)# no private-vlan isolated <cr>
Community Type	Switch(config-vlan)# private-vlan community <cr>
Private VLAN Port Configuraiton	
Go to the port configuraiton	Switch(config)# interface (port_number, ex: gi9) Switch(config-if)# switchport private-vlan host-association Set the private VLAN host association mapping map primary VLAN to secondary VLAN
Private VLAN Port Type	Switch(config-if)# switchport mode svl Shared vlan learning private-vlan Set private-vlan mode
Promiscuous Port Type	Switch(config-if)# switchport mode private-vlan host-association Set the private VLAN host association mapping map primary VLAN to secondary VLAN
Host Port Type	Switch(config-if)# switchport mode private-vlan promiscuous Switch(config-if)#no switchport mode private-vlan promiscuous <cr> Switch(config-if)# switchport mode private-vlan host <cr>
Private VLAN Port Configuration PVLAN Port Type	Switch(config)# interface gi9 Switch(config-if)# switchport mode private-vlan host
Host Association primary to secondary (The command is only available for host port.)	Switch(config-if)# switchport private-vlan host-association <2-4094> Primary range VLAN ID of the private VLAN port association Switch(config-if)# switchport private-vlan host-association 2 <2-4094> Secondary range VLAN ID of the private VLAN port association Switch(config-if)# switchport private-vlan host-association 2 3
Mapping primary to secondary VLANs (This command is only available for promiscuous port)	Switch(config)# interface gi10 Switch(config-if)# switchport mode private-vlan promiscuous Switch(config-if)# switchport private-vlan mapping 2 add 3 Switch(config-if)# switchport private-vlan mapping 2 add 4 Switch(config-if)# switchport private-vlan mapping 2 add 5
Private VLAN Information	
Private VLAN Information	Switch# show vlan private-vlan FLAGS: I -> Isolated P -> Promiscuous C -> Community Primary Secondary Type Ports ----- 2 3 Isolated gi10(P),gi9(I)

	<pre> 2 4 Community gi10(P),gi8(C) 2 5 Community gi10(P),gi7(C),gi9(I) 10 - - - </pre>
PVLAN Type	<pre> Switch# show vlan private-vlan type Vlan Type Ports ----- 2 primary gi10 3 isolated gi9 4 community gi8 5 community gi7,gi9 10 primary - </pre>
Host List	<pre> Switch# show vlan private-vlan port-list Ports Mode Vlan ----- 1 normal - 2 normal - 3 normal - 4 normal - 5 normal - 6 normal - 7 host 5 8 host 4 9 host 3 10 promiscuous 2 </pre>
Running Config Information	<pre> Switch# show run Building configuration... Current configuration: hostname Switch vlan learning independent ! vlan 1 ! Private VLAN Type vlan 2 private-vlan primary ! vlan 3 private-vlan isolated ! vlan 4 private-vlan community ! vlan 5 private-vlan community ! Private VLAN Port Information interface gigabitethernet7 switchport access vlan add 2,5 switchport trunk native vlan 5 switchport mode private-vlan host switchport private-vlan host-association 2 5 ! interface gigabitethernet8 switchport access vlan add 2,4 switchport trunk native vlan 4 </pre>

```
switchport mode private-vlan host
switchport private-vlan host-association 2 4
!
interface gigabitethernet9
  switchport access vlan add 2,5
  switchport trunk native vlan 5
  switchport mode private-vlan host
  switchport private-vlan host-association 2 3
!
interface gigabitethernet10
  switchport access vlan add 2,5
  switchport trunk native vlan 2
  switchport mode private-vlan promiscuous
  switchport private-vlan mapping 2 add 3-5
.....
.....
```

4.7 Traffic Prioritization

Quality of Service (QoS) provides traffic prioritization mechanism which allows users to deliver better service to certain flows. QoS can also help to alleviate congestion problems and ensure high-priority traffic is delivered first. This section allows you to configure Traffic Prioritization settings for each port with regard to setting priorities.

JetNet QoS supports 8 physical queues, round robin (RR), weighted fair queuing (WRR) and Strict Priority scheme, which follows 802.1p COS tag and IPv4 TOS/DiffServ information to prioritize the traffic of your industrial network.

Following commands are included in this group:

4.7.1 QoS Setting

4.7.2 Port-based Queue Mapping

4.7.3 CoS-Queue Mapping

4.7.4 DSCP-Priority Mapping

4.7.5 CLI Commands of the Traffic Prioritization

4.7.1 QoS Setting

In QoS setting, you should choose the QoS Priority Mode first, Port-Based, Cos or DSCP modes. Choose the preferred mode and you can configure the next settings in its own

QoS Setting

QoS Trust Mode

- 802.1P priority tag
- DSCP/TOS code point

Queue Scheduling

- Use a Round Robin scheme
- Use a Strict Priority scheme
- Use Weighted Round Robin scheme

Queue	0	1	2	3	4	5	6	7
Weight	1	1	1	1	1	1	1	1

configuration pages. The other page of the mode you don't select can't be configured.

In QoS setting, you should choose the QoS Priority Mode first, Port-Based, Cos or DSCP modes. Choose the preferred mode and you can configure the next settings in its own configuration pages. The other page of the mode you don't select can't be configured.

Queue Scheduling

You can select the Queue Scheduling rule as follows:

Use a Round Robin scheme. The Round Robin scheme means all the priority has the same privilege, the traffic is forward cyclic from highest to lowest.

Use a strict priority scheme. Packets with higher priority in the queue will always be processed first, except that there is no packet with higher priority.

Use Weighted Round Robin scheme. This scheme allows users to assign new weight ratio for each class. The 10 is the highest ratio. The ratio of each class is as below:

$$Wx / W0 + W1 + W2 + W3 + W4 + W5 + W6 + W7 \text{ (Total volume of Queue 0-7)}$$

4.7.2 Port-based Queue Mapping

Choose the Queue value of each port, the port then has its default priority. The Queue 3 is the highest port-based queue, 0 is the lowest queue. The traffic injected to the port follows the queue level to be forwarded, but the outgoing traffic doesn't bring the queue level to next switch.

After configuration, press **Apply** to enable the settings.

QoS Setting

QoS Trust Mode

- 802.1P priority tag
- DSCP/TOS code point

Queue Scheduling

- Use a Round Robin scheme
- Use a Strict Priority scheme
- Use Weighted Round Robin scheme

Queue	0	1	2	3	4	5	6	7
Weight	<input type="text"/>	<input type="text"/>	<input type="text"/>	<input type="text"/>	<input type="text"/>	<input type="text"/>	<input type="text"/>	<input type="text"/>

Port Setting

Port	Priority
1	0
2	0
3	0
4	0
5	0
6	0
7	0
8	0
9	0
10	0

Apply

4.7.3 CoS-Queue Mapping

This page is to change CoS values to Physical Queue mapping table. Since the switch fabric of JetNet only supports 4 physical queues, Lowest, Low, Middle and High. Users should therefore assign how to map CoS value to the level of the physical queue.

In JetNet, users can freely assign the mapping table or follow the suggestion of the 802.1p standard. Korenix uses 802.p suggestion as default values. You can find CoS values 1 and 2 are mapped to physical Queue 0, the lowest queue. CoS values 0 and 3 are mapped to physical Queue 1, the low/normal physical queue. CoS values 4 and 5 are mapped to

physical Queue 2, the middle physical queue. CoS values 6 and 7 are mapped to physical Queue 3, the high physical queue.

CoS-Queue Mapping

CoS-Queue Mapping

CoS	0	1	2	3	4	5	6	7
Queue	0 ▾	1 ▾	2 ▾	3 ▾	4 ▾	5 ▾	6 ▾	7 ▾

Note: Queue 7 is the highest priority queue in using Strict Priority scheme.

Apply

After configuration, press **Apply** to enable the settings.

4.7.4 DSCP-Priority Mapping

This page is to change DSCP values to Priority mapping table. The system provides 0–63 DSCP priority level. Each level can map to one priority ID

DSCP-Priority Mapping

DSCP-Priority Mapping

DSCP	0	1	2	3	4	5	6	7
Priority	0 ▾	0 ▾	0 ▾	0 ▾	0 ▾	0 ▾	0 ▾	0 ▾
DSCP	8	9	10	11	12	13	14	15
Priority	1 ▾	1 ▾	1 ▾	1 ▾	1 ▾	1 ▾	1 ▾	1 ▾
DSCP	16	17	18	19	20	21	22	23
Priority	2 ▾	2 ▾	2 ▾	2 ▾	2 ▾	2 ▾	2 ▾	2 ▾
DSCP	24	25	26	27	28	29	30	31
Priority	3 ▾	3 ▾	3 ▾	3 ▾	3 ▾	3 ▾	3 ▾	3 ▾
DSCP	32	33	34	35	36	37	38	39
Priority	4 ▾	4 ▾	4 ▾	4 ▾	4 ▾	4 ▾	4 ▾	4 ▾
DSCP	40	41	42	43	44	45	46	47
Priority	5 ▾	5 ▾	5 ▾	5 ▾	5 ▾	5 ▾	5 ▾	5 ▾
DSCP	48	49	50	51	52	53	54	55
Priority	6 ▾	6 ▾	6 ▾	6 ▾	6 ▾	6 ▾	6 ▾	6 ▾
DSCP	56	57	58	59	60	61	62	63
Priority	7 ▾	7 ▾	7 ▾	7 ▾	7 ▾	7 ▾	7 ▾	7 ▾

Apply

After configuration, press **Apply** to enable the settings.

4.7.5 CLI Commands of the Traffic Prioritization

Command Lines of the Traffic Prioritization configuration

Feature	Command Line
QoS Setting	
Queue Scheduling – Strict Priority	Switch(config)# qos queue-sched rr Round Robin sp Strict Priority wrr Weighted Round Robin Switch(config)# qos queue-sched sp The queue scheduling scheme is setting to Strict Priority.
Queue Scheduling – Round Robin	Switch(config)# qos queue-sched rr The queue scheduling scheme is setting to Round Robin.
Queue Scheduling – WRR	Switch(config)# qos queue-sched wrr <1-10> Weights for COS queue 0 (queue_id 0) Switch(config)# qos queue-sched wrr 10 <1-10> Weights for COS queue 1 (queue_id 1) Switch(config)# qos queue-sched wrr 1 2 3 4 5 6 7 8 The queue scheduling scheme is setting to Weighted Round Robin. Assign the ratio for the 8 classes of service.
Port Setting – CoS (Default Port Priority)	Switch(config)# interface gi1 Switch(config-if)# qos priority <0-7> Assign a priority queue Switch(config-if)# qos priority 3 The priority queue is set 3 ok. Note: When change the port setting, you should Select the specific port first. Ex: gi1 means Gigabit Ethernet port 1.
QoS Trust Mode	Switch(config)# qos trust-mode cos CoS dscp DSCP/TOS Switch(config)# qos trust-mode dscp Set QoS trust mode dscp ok Switch# show trust-mode QoS Trust Mode: DSCP/TOS code point
Display – Queue Scheduling	Switch# show qos queue-sched QoS queue scheduling scheme : Weighted Round Robin COS queue 0 = 1 COS queue 1 = 2 COS queue 2 = 3 COS queue 3 = 4 COS queue 4 = 5 COS queue 5 = 6 COS queue 6 = 7 COS queue 7 = 8
Display – Port Priority Setting (Port Default Priority)	Switch# show qos port-priority Port Default Priority : Port Priority Queue -----+----- 1 7

	<pre> 2 0 3 0 4 0 26 0 27 0 28 0 </pre>
CoS-Queue Mapping	
Format	<pre> Switch(config)# qos cos-map PRIORITY Assign an priority (7 highest) Switch(config)# qos cos-map 1 QUEUE Assign an queue (0-7) </pre> <p>Note: Format: qos cos-map priority_value queue_value</p>
Map CoS 0 to Queue 1	<pre> Switch(config)# qos cos-map 0 1 The CoS to queue mapping is set ok. </pre>
Map CoS 1 to Queue 0	<pre> Switch(config)# qos cos-map 1 0 The CoS to queue mapping is set ok. </pre>
Map CoS 2 to Queue 0	<pre> Switch(config)# qos cos-map 2 0 The CoS to queue mapping is set ok. </pre>
Map CoS 3 to Queue 1	<pre> Switch(config)# qos cos-map 3 1 The CoS to queue mapping is set ok. </pre>
Map CoS 4 to Queue 2	<pre> Switch(config)# qos cos-map 4 2 The CoS to queue mapping is set ok. </pre>
Map CoS 5 to Queue 2	<pre> Switch(config)# qos cos-map 5 2 The CoS to queue mapping is set ok. </pre>
Map CoS 6 to Queue 3	<pre> Switch(config)# qos cos-map 6 3 The CoS to queue mapping is set ok. </pre>
Map CoS 7 to Queue 3	<pre> Switch(config)# qos cos-map 7 3 The CoS to queue mapping is set ok. </pre>
Display – CoS-Queue mapping	<pre> Switch# sh qos cos-map CoS to Queue Mapping : CoS Queue ---- + ----- 0 1 1 0 2 0 3 1 4 2 5 2 6 3 7 3 </pre>
DSCP-Priority Mapping	
Format	<pre> Switch(config)# qos dscp-map DSCP DSCP code point in binary format (000000-111111) Switch(config)# qos dscp-map 0 PRIORITY 802.1p priority bit (0-7) </pre> <p>Format: qos dscp-map priority_value queue_value</p>
Map DSCP 0 to Queue 1	<pre> Switch(config)# qos dscp-map 0 1 The TOS/DSCP to queue mapping is set ok. </pre>
Display – DSCO-Queue mapping	<pre> Switch# show qos dscp-map DSCP to Queue Mapping : (dscp = d1 d2) </pre>

d2	0	1	2	3	4	5	6	7	8	9
d1										
	-----+									
0		1	0	0	0	0	0	0	1	1
1		1	1	1	1	1	1	2	2	2
2		2	2	2	3	3	3	3	3	3
3		3	3	4	4	4	4	4	4	4
4		5	5	5	5	5	5	6	6	6
5		6	6	6	6	6	7	7	7	7
6		7	7	7	7					

4.8 Multicast Filtering

For multicast filtering, *JetNet 6828Gf* uses IGMP Snooping technology. IGMP (Internet Group Management Protocol) is an Internet Protocol that provides a way for internet device to report its multicast group membership to adjacent routers. Multicasting allows one computer on the internet to send data to a multitude of other computers that have identified themselves as being interested in receiving the originating computers data.

Multicasting is useful for such applications as updating the address books of mobile computer users in the field, sending out newsletters to a distribution list, and broadcasting streaming media to an audience that has tuned into the event by setting up multicast group membership.

In effect, IGMP Snooping manages multicast traffic by making use of switches, routers, and hosts that support IGMP. Enabling IGMP Snooping allows the ports to detect IGMP queries, report packets, and manage multicast traffic through the switch. IGMP has three fundamental types of messages, as shown below:

Message	Description
Query	A message sent from the querier (an IGMP router or a switch) which asks for a response from each host that belongs to the multicast group.
Report	A message sent by a host to the querier to indicate that the host wants to be or is a member of a given group indicated in the report message.
Leave Group	A message sent by a host to the querier to indicate that the host has quit as a member of a specific multicast group.

You can enable **IGMP Snooping** and **IGMP Query** functions here. You will see the information of the IGMP Snooping function in this section, including different multicast groups' VID and member ports, and IP multicast addresses that range from 224.0.0.0 to 239.255.255.255.

In this section, Force filtering can determined whether the switch flooding unknown multicast or not.

Following commands are included in this group:

4.8.1 IGMP Snooping

4.8.2 IGMP Query

4.8.3 Unknown Multicast

4.8.4 GMRP Configuration

4.8.5 CLI Commands of the Multicast Filtering

4.8.1 IGMP Snooping

This page is to enable IGMP Snooping feature, assign IGMP Snooping for specific VLAN, and view IGMP Snooping table from dynamic learnt or static manual key-in. *JetNet6828Gf* support IGMP snooping V1/V2/V3 automatically and IGMP query V1/V2.

IGMP Snooping, you can select **Enable** or **Disable** here. After enabling IGMP Snooping, you can then enable IGMP Snooping for specific VLAN. You can enable IGMP Snooping for some VLANs so that some of the VLANs will support IGMP Snooping and others won't.

To assign IGMP Snooping to VLAN, please select VLAN ID to enable/disable IGMP

Snooping function, or select the “IGMP Snooping” global setting for all VLANs. Then press **Apply**. In the same way, you can also **Disable** IGMP Snooping for certain VLANs.

IGMP Snooping

Apply

VID	IGMP Snooping	Source Only Learning
1	Enable	Enable
2	Disable	Disable

Apply

Filtering Mode Setting: you can select Filtering Mode on this Page.

Send to Query Ports: The unknown multicast will be sent to the Query ports. The Query port means the port received the IGMP Query packets. It is usually the uplink port of the switch.

Send to All Ports: The unknown multicast will be flooded to all ports of the same VLAN, even they are not the IGMP member ports of the groups.

Discard: The unknown multicast will be discarded. Non-member ports will not receive the unknown multicast streams.

This page allows you to decide how to forward the unknown multicast traffic.

IGMP Snooping Table: In the table, you can see multicast group IP address, VLAN ID it belongs to, and member ports of the multicast group. *JetNet 6828Gf* supports 256 multicast groups. Click on **Reload** to refresh the table.

IGMP Snooping Table

IP Address	VID	1	2	3	4	5	6	7	8	9	10
239.255.255.250	1	<input type="checkbox"/>	<input type="checkbox"/>	<input type="checkbox"/>	<input type="checkbox"/>	<input type="checkbox"/>	<input checked="" type="checkbox"/>	<input type="checkbox"/>	<input type="checkbox"/>	<input type="checkbox"/>	<input type="checkbox"/>
239.192.8.0	1	<input type="checkbox"/>	<input type="checkbox"/>	<input type="checkbox"/>	<input type="checkbox"/>	<input type="checkbox"/>	<input checked="" type="checkbox"/>	<input type="checkbox"/>	<input type="checkbox"/>	<input type="checkbox"/>	<input type="checkbox"/>

Reload

4.8.2 IGMP Query

IGMP Query

IGMP Query on the Management VLAN

Version	Version 1 ▾
Query Interval(s)	125
Query Maximum Response Time(s)	0

This page allows users to configure **IGMP Query** feature. Since *JetNet 6828Gf* can only be configured by member ports of the management VLAN, IGMP Query can only be enabled on the management VLAN. If you want to run IGMP Snooping feature in several VLANs, you should notice that whether each VLAN has its own IGMP Querier first.

The IGMP querier periodically sends query packets to all end-stations on the LANs or VLANs that are connected to it. For networks with more than one IGMP querier, a switch with the lowest IP address becomes the IGMP querier.

In IGMP Query selection, you can select V1, V2 or Disable. **V1** means IGMP V1 General Query and **V2** means IGMP V2 General Query.. The query will be forwarded to all multicast groups in the VLAN. **Disable** allows you to disable IGMP Query.

Query Interval(s): The period of query sent by querier.

Query Maximum Response Time: The span querier detect to confirm there are no more directly connected group members on a LAN.

Once you finish configuring the settings, click on **Apply** to apply your configuration.

4.8.3 Unknown Multicast

After enabled IGMP Snooping, the known multicast can be filtered by IGMP Snooping mechanism and forwarded to the member ports of the known multicast groups. The other multicast streams which are not learnt is so-called unknown multicast, the switch decide how to forward them based on the setting of this page.

Send to All Ports: The unknown multicast will be flooded to all ports of the same VLAN, even they are not the IGMP member ports of the groups.

Discard: The unknown multicast will be discarded. Non-member ports will not receive the unknown multicast streams.

This page allows you to decide how to forward the unknown multicast traffic.

Unknown Multicast

Unknown Multicast

- Send to All Ports
 Discard

Apply

Once you finish configuring the settings, click on **Apply** to apply your configuration.

4.8.4 GMRP Configuration

To enable the GMRP configuration, the Global GMRP Configuration should be enabled first. And all the port interfaces should enable GMRP learning as well. Then the switch exchange the IGMP Table with other switches which is also GMRP-aware devices.

GMRP Configuration

GMRP Protocol

Port	State
1	Disable
2	Disable
3	Enable
4	Disable
5	Disable
6	Disable
7	Disable
8	Disable
9	Disable
10	Disable

Apply

4.8.5 CLI Commands of the Multicast Filtering

Command Lines of the multicast filtering configuration

Feature	Command Line
IGMP Snooping	
IGMP Snooping - Global	Switch(config)# ip igmp snooping IGMP snooping is enabled globally. Please specify on which vlans IGMP snooping enables Switch(config)# ip igmp snooping <?>

	<p>immediate-leave leave group when receive a leave message</p> <p>last-member-query-interval the interval for which the switch waits before updating the table entry</p> <p>source-only-learning Source-Only-Learning</p> <p>vlan Virtual LAN</p>
IGMP Snooping - VLAN	<pre>Switch(config)# ip igmp snooping vlan VLANLIST allowed vlan list all all existed vlan Switch(config)# ip igmp snooping vlan 1-2 IGMP snooping is enabled on vlan 1 IGMP snooping is enabled on vlan 2</pre>
Disable IGMP Snooping – Global	<pre>Switch(config)# no ip igmp snooping IGMP snooping is disabled globally ok.</pre>
Disable IGMP Snooping - VLAN	<pre>Switch(config)# no ip igmp snooping vlan 3 IGMP snooping is disabled on VLAN 3.</pre>
Display – IGMP Snooping Setting	<pre>Switch# sh ip igmp interface vlan1 enabled: Yes version: IGMPv1 query-interval; 125s query-max-response-time: 10s Switch# sh ip igmp snooping IGMP snooping is globally enabled Vlan1 is IGMP snooping enabled immediate-leave is disabled last-member-query-interval is 100 centiseconds Vlan2 is IGMP snooping enabled immediate-leave is disabled last-member-query-interval is 100 centiseconds Vlan3 is IGMP snooping disabled immediate-leave is disabled last-member-query-interval is 100 centiseconds</pre>
Display – IGMP Table	<pre>Switch# sh ip igmp snooping multicast all VLAN IP Address Type Ports ----- 1 239.192.8.0 IGMP fa6, 1 239.255.255.250 IGMP fa6,</pre>
IGMP Query	
IGMP Query V1	<pre>Switch(config)# int vlan 1 (Go to management VLAN) Switch(config-if)# ip igmp v1</pre>
IGMP Query V2	<pre>Switch(config)# int vlan 1 (Go to management VLAN) Switch(config-if)# ip igmp</pre>
IGMP Query version	<pre>Switch(config-if)# ip igmp version 1 Switch(config-if)# ip igmp version 2</pre>
Disable	<pre>Switch(config)# int vlan 1 Switch(config-if)# no ip igmp</pre>
Display	<pre>Switch# sh ip igmp interface vlan1 enabled: Yes version: IGMPv2 query-interval: 125s query-max-response-time: 10s</pre>

	<pre>Switch# show running-config ! interface vlan1 ip address 192.168.10.17/24 ip igmp no shutdown !</pre>
Unknown Multicast	
Send to Query Ports –	<pre>Switch(config)# ip igmp snooping source-only-learning vlan VLANLIST allowed VLAN list all all VLAN Switch(config)# ip igmp snooping source-only-learning vlan 1 IGMP Snooping Source-Only-Learning is enabled on VLAN 1</pre>
Discard (Force filtering)	<pre>Switch(config)# mac-address-table multicast filtering vlan VLANLIST allowed VLAN list all all VLAN Switch(config)# mac-address-table multicast filtering vlan 2</pre>
Send to All Ports (Flood to all VLAN member ports)	<pre>Switch(config)# no mac-address-table multicast filtering vlan VLANLIST allowed VLAN list all all VLAN Switch(config)# no mac-address-table multicast filtering vlan 1</pre>

4.9 Routing

Layer 3 Routing Feature is the most important feature of the the Layer 3 Modular Managed Ethernet Switch. Since the hosts located in different broadcast domain can't communicate by themselves, once there is a need to communicate among the different VLANs, the layer 3 routing feature is requested.

The JetNet 6828Gf equips with a Layer 3 chipset which can perform wire-speed layer 3 routing performance. The JetNet 6828Gf combines Layer 2 switching and Layer 3 routing within the single platform. No matter how many VLAN/IP interfaces created, how much layer 2 switching traffic or layer 3 routing traffic within the JetNet 6828Gf can be forwarded/routed without any packet lost.

In the Routing Configuration pages allows users create the Routing Interfaces, enable routing capability, enable unicast/multicast routing protocols, configure router redundancy policy and check the related routing information.

Following commands are included in this group:

4.9.1 ARP

4.9.2 IP

4.9.3 Router

4.9.4 RIP

4.9.5 OSPF

4.9.6 Multicast Route

4.9.7 VRRP

4.9.1 ARP

ARP is the name of Address Resolution Protocol, it is a network layer protocol. ARP is query by broadcast and reply by unicast packet format. It assists IP protocol to find out the MAC address of an IP destination. It is important to find out the destination MAC address due to the MAC address is unique in the network, then the traffic can be correctly directed to the destination.

An ARP table must include the table with MAC Address/IP Address pair, storing information from the ARP reply, saving ARP operation for frequent communication and the entries are timeout with an aging mechanism.

The Web GUI below allows user to configure the Age Time of the ARP entry and see the count of static and dynamic ARP entries.

ARP Table Configuration

Age Time (secs)	9600
Total Entry Count	1
Static Entry Count	0
Dynamic Entry Count	1

Apply

Age Time (secs): This is the Age time setting of the ARP entry. Once there is no packet (IP+MAC) hit the entry within the time, the entry will be aged out. Short ARP age time leads the entry aged out easier and re-learn often, the re-learn progress lead the communication stop. The default setting is 14,400 seconds (4hrs), it is also suggested value in the real world.

Type the new time and press “**Apply**” to change it.

Total Entry Count: This count represents for the count of total entries the ARP Table has.

Static Entry Count: This count represents for the count the static entries user configured.

Dynamic Entry Count: This count represents for the count the ARP table dynamically learnt.

To configure the static ARP entry, or to see the entries of the ARP table, please use the Console CLI.

4.9.2 IP

An IP Interface is the basic unit while routing, it is a logical interface which equips with an IP network and acts as the default gateway of the attached clients. The network interface can be a port or a single VLAN. All the client members connected to the IP network can be routed through the network interface.

Below figure is a simple network which has 3 network interfaces. The interface VLAN 2 equips with 210.68.147.0 network, the interface VLAN 14 equips with 210.68.150.0 network and the interface VLAN 99 equips with 210.68.148.0 network. The VLAN ID is the logical interface which can be assigned with one IP address and subnet mask, the IP addresses within the subnet can be switched as a broadcast domain. Once the client wants within the subnet wants to communicate with another network, the traffic will be routed through the layer 3 switch.

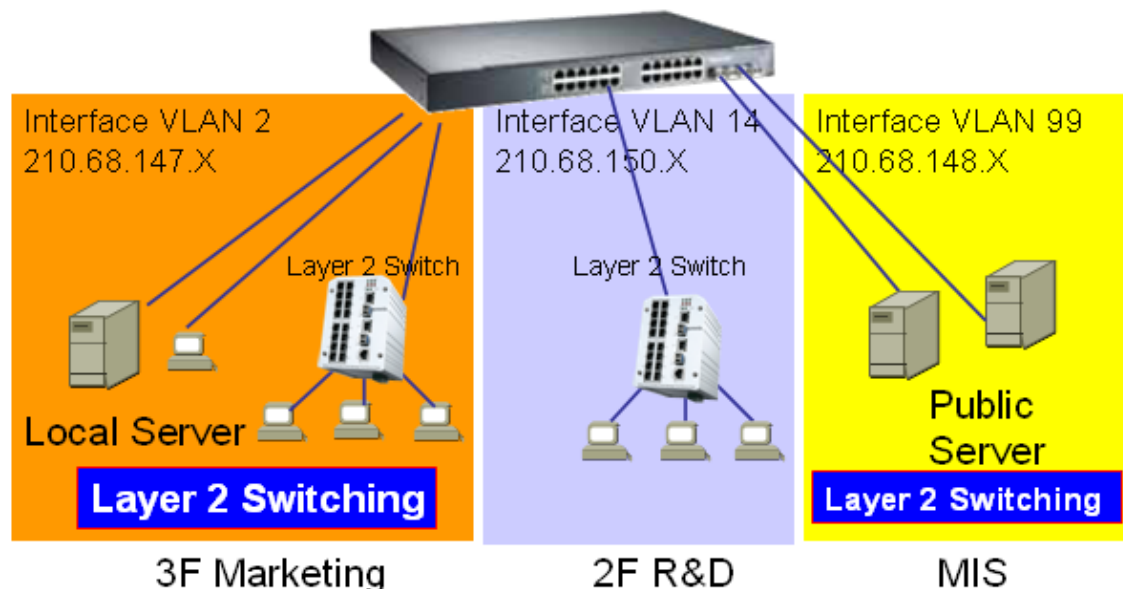

4.9.2.1 IP Configuration

The IP Configuration page allows user enable the global IP Routing feature in the switch and create IP address to each network interface.

Routing Mode: This command allows user to **Enable** or **Disable** the global IP Routing mode. After Enabled, the switch can route traffic. If it is Disabled, the switch acts as a pure layer 2 switch, all the traffic can NOT be routed. [All the network settings of routing protocols will be disabled and deleted.](#)

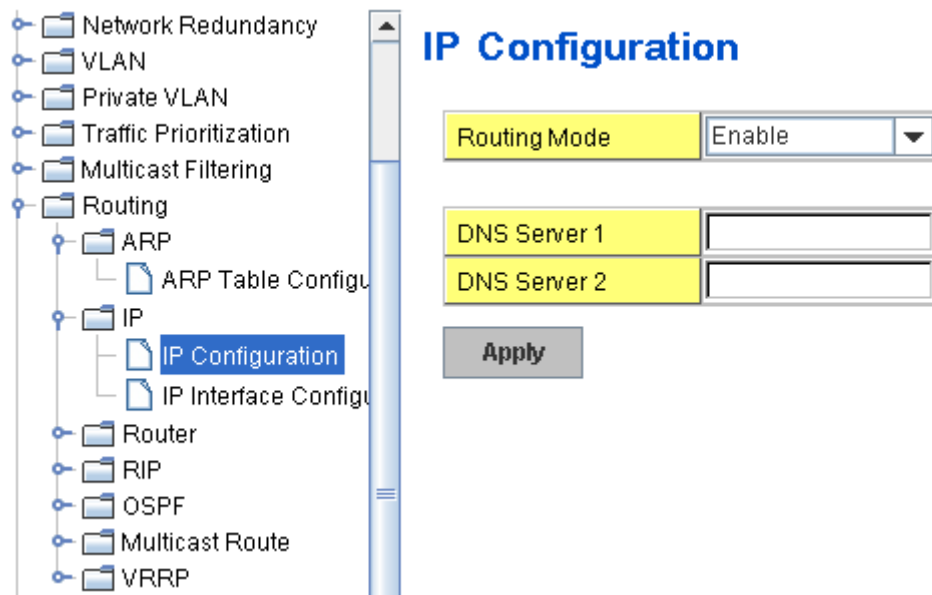

DNS Server: Type the preferred IP address of the DNS Server here.

Once you finish configuring the settings, click on **Apply** to apply your configuration.

4.9.2.2 IP Interface Configuration

This page allows you Enable the IP Routing interface and assign the IP Address for it.

Before creating IP Interface, you should create VLAN Interface and assign the member port to the VLAN. Please refer to the VLAN Configuration for detail. The IP Interface table listed all the created VLAN automatically, you can change the setting for each VLAN here.

The JetNet 5828G allows you to create up to 128 IP Interfaces in whole system. Each VLAN Interface accepts up to 32 IP Address, one is the primary IP Address, the others are secondary IP Addresses. The IP Address is the default gateway of its attached members.

This is the IP Interface Configuration Table.

IP Interface Configuration

Interface	Status	State	IP Address	SubnetMask
vlan1	Up	Enable	192.168.10.43	255.255.255.0
vlan2	Up	Enable	192.168.2.254	255.255.255.0
vlan3	Down	Enable	192.168.3.254	255.255.255.128 255.255.255.192 255.255.255.224 255.255.255.240 255.255.255.248 255.255.255.252 255.255.255.254

Apply

Static Route: A static route entry to and from a stub network to another stub network. The static route is usually configured to connect the neighbor router/switch, the both routers/switches then can communicate through the route.

While configuring Static Route, all the fields in Route entry like the destination network and its netmask, the valid route interface to the destination and distance are needed to be specified.

Route Entry Configuration

Default Route

Apply

Static Route Entry

Destination	Netmask	Gateway	Distance
<input type="text" value="192.168.11.0"/>	<input type="text" value="255.255.255.0"/>	<input type="text" value="192.168.10.254"/>	<input type="text" value="1"/>

Add

Route Entry Table

Destination	Netmask	Gateway	Distance	Metric	Interface
192.168.11.0	255.255.255.0	192.168.10.254	1	0	vlan1

Remove

Reload

4.9.3.2 Route Table

This page displays the routing table information.

Routing Table

Routing Protocol	Destination	Connected via	Interface	Status
OSPF	192.168.2.0/24	-	vlan2	active
connected	192.168.2.0/24	-	vlan2	active
connected	192.168.3.0/24	-	vlan3	active
OSPF	192.168.3.0/24	-	vlan3	active
OSPF	192.168.4.0/24	192.168.3.253	vlan3	active
OSPF	192.168.5.0/24	192.168.2.254	vlan2	active
OSPF	192.168.10.0/24	192.168.2.254	vlan2	active
OSPF	192.168.12.0/24	-	vlan1	active
connected	192.168.12.0/24	-	vlan1	active
OSPF	192.168.13.0/24	192.168.3.253	vlan3	active

Reload

The system maintains the routing table information and updates it once the routing interfaces changed. The routing table information is important to find out the possible and best route in the field especially when troubleshooting the network problem.

The definition of the fields is listed in below:

Routing Protocol: The field shows the entry is a local interface or learnt from the routing protocol. For example: The “**connected**” represents for the local interface. The “**OSPF**” shows the entry is learnt from the routing protocol, OSPF.

Destination: The destination network of this entry.

Connected Via: The IP interface wherever the network learnt from. The interface is usually the next hop’s IP address.

Interface: The VLAN Interface wherever the network connected to or learnt from.

Status: Shows the entry is active or not.

4.9.4 RIP

The RIP is short of the Routing Information Protocol. RIP was in widespread use years before it was standardized in as RFC 1058 in 1988. Version 2 of RIP was completed in 1994.

RIP is the most known Distance Vector type dynamic routing protocol, or known as Hop Based routing protocol. It uses hop count as a distance metric, each router advertises its routing table every 30 seconds. The maximum routers RIP can support is 15, the 16th router represents Infinity.

When a router receives a neighbor’s table, it examines it entry by entry. If the destination is new, it is added to the local routing table. If the destination is known before and the update provides a smaller metric, the existing entry in the local routing table is replaced. Adds 1 (or sometimes more if the corresponding link is slow) to the metric. If no route updated within the cycles, the entry is removed.

The figure in the right shows the RIP routing table of router A, B and C.

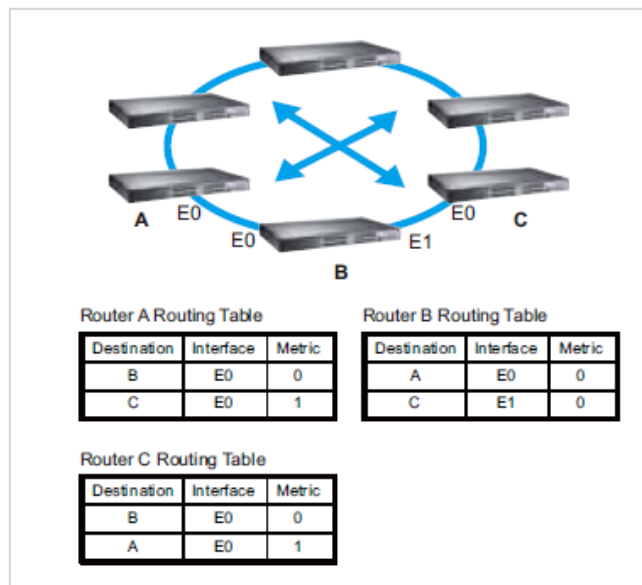

RIP Configuration

This page shows how to configure RIP protocol.

RIP Protocol: Choose the RIP **Version 1** or **Version 2** or **Disable** RIP protocol in here.

Routing for Networks: All the networks no matter directly connected or learnt from other router/switch should be added to the switch. The format is IP Network/bit mask. For example, 192.168.100.0/24. After type the network address, click “**Add**” to the RIP table.

Select the network address and click “**Remove**” to remove it.

Click “**Reload**” to see the updated RIP table.

RIP Configuration

RIP Protocol Version 2 ▾

Apply

Disable
Version 1
Version 2

Routing for Networks

Network Address (A.B.C.D/M)

Add

Index	Network Address
1	192.168.10.0/24

Remove Reload

RIP Interface Configuration

In RIP Interface Configuration, you can configure Send Version and Receiver Version.

Select the RIP Version of the interface.

Once you finish configuring the settings, click on **Apply** to apply your configuration.

RIP Interface Configuration

Interface	Send Version	Receive Version
vlan1	RIPv2	RIPv2 ▾
vlan2	RIPv2	RIPv2
vlan5	RIPv2	RIPv2

Apply Reload

4.9.5 OSPF

The OSPF is short of the Open Shortest Path First.

OSPF is a link-state protocol. The Link is an interface on the router, it equips the IP, mask, the type of network, the routers connected to that network. The State is its relationship to its neighboring routers. The Metric is the distance between the 2 links, it is usually the bandwidth of the link in link-state protocol. The Link State Database is the collection of all these link states. The destination network address, the shortest metric to the network and the IP address of the next hop are specified in the link state database.

The figure in the right is the example OSPF network. There are 6 routing switch, A~F. The Routers/Switch periodically sends "Hello" packets to the neighbors and exchange OSPF link state with each other and then update the Routing table of each router/switch.

Use the communication between A to C for example. In hop-based routing protocol, like RIP, the A to C is the shortest way.

However, in link-state protocol, like the OSFP, the A to D to C is the shortest way. This is calculated by the *Dijkstra's SPF Algorithm*. After calculated and routing table updated, the metric from A to C is 32, the metric from A to D to C is 30. The A to D to C will be selected as the best route from A to C.

The OSPF is a complex protocol which defines the role of the router/switch when it is installed in different Areas of the autonomous system. The Area is a group of routers, the OSPF uses flooding to exchange link-state updates between routers. The routers within the same area update its routing table. Any change in routing information is flooded to all routers in the same area.

The JetNet 6828Gf OSPF design comforms to the OSPF Version 2 specification. Typically, the JetNet 6828Gf acts as the Internal Router, a router within the area; the Designated Router, the Master router in the same broadcast domain within the area; the Area Board Router which is the boundary router between different area. While configuring the OSPF network, the area ID should be configured with the same IP address or the same area ID. The 0.0.0.0 is usually used.

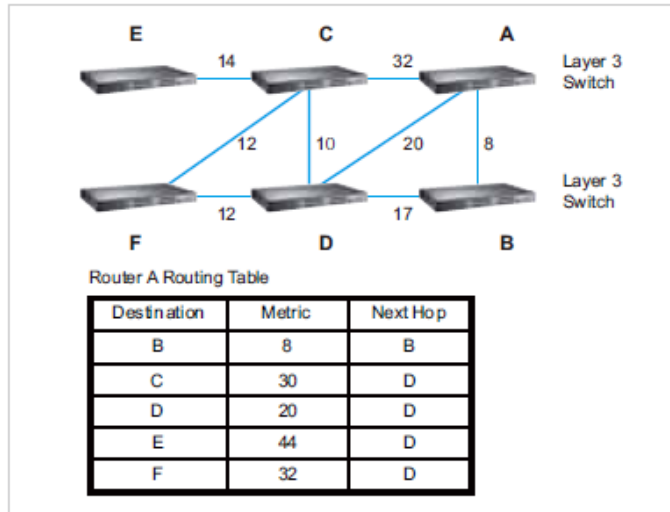

4.9.5.1 OSPF Configuration

This page allows user to enable OSPF setting and configure the related settings and networks.

OSPF Protocol: Enable or Disable the OSFP routing protocol.

Router ID: The router ID can be any IP address, however, the IP address of the existed local interface is suggested. With such IP address, you can find the router/switch easier.

Router ID is used while connected multiple OSPF routers/switches to the same broadcast domain, the lowest Router ID will be selected as the Designated Router in the network.

Routing for Network: Type the network address and the Area ID in the field. Click "Add" to apply the setting. You can see the network table in below.

Note: All the Area ID of the router/switch within the same area should use the same IP

address or ID. All the network address should be added.

Select the Network Address, then you can “**Remove**” the setting.

Click “**Reload**” to reload the new entry.

OSPF Basic

OSPF Protocol

Router ID

Routing for Networks

Network Address Area (0~4294967295 or IP)

Index	Network Address	Area
1	192.168.12.0/24	0.0.0.0
2	192.168.2.0/24	0.0.0.0
3	192.168.3.0/24	0.0.0.0

4.9.5.2 OSPF Interface Configuration

This page allows user to see the OSPF network address and the parameters of each interface.

OSPF Interface Configuration

Interface	Area	Cost	Priority	Transmit Delay	Hello	Dead	Retransmit
vlan1	0.0.0.0	10	1	1	10	40	5
vlan2	0.0.0.0	10	1	1	10	40	5
vlan5	0.0.0.0	10	1	1	10	40	5

Interface: The VLAN Interface name.

Area: The area ID of the Interface you added. The Area ID must be the same for all routers/switches on a network.

Cost: The distance of this link/Interface, the default is identified depends on what the bandwidth is by the system. The value can be changed to decide the best router.

Priority: The priority of this link/Interface. Set priority to help find the OSPF designated router for a network. The default is 1. The range is 0 to 255.

Transmit Delay: The transmit delay timer of this link/Interface. Transmit Delay is the estimated number of seconds to wait before sending a link state update packet. The default value is 1 second.

Hello: The Hello timer of this link/Interface. The value must be the same for all routers/switches on a network. The default value is 10 seconds. The min. value is 1.

Dead: The Dead Interval Timer of this link/Interface. The Dead timer is the time to identify whether the interface is down or not before the neighbors declare the OSPF router to be down. The default value is 4 times (40 seconds) than the Hello interval (default is 10).

Retransmit: The count of Retransmit of this link/Interface. The Retransmit time specifies the number of seconds between link state advertisement transmissions. The default value is 5 seconds.

Once you finish configuring the settings, click on **Apply** to apply your configuration.

4.9.5.3 OSPF Neighbor Table

This page allows user to see the OSPF Neighbor information. The Neighbor interface and its state will be listed here.

Below is the example of a simple OSPF environment. The Hello packets are exchanged between the switch to next switches. While the **State** is changed to "Full", that means the exchange progress is done. The **Neighbor ID** is the Router ID of the Neighbor routers/switches. The **Priority** is the priority of the link. The **Dead Time** is the activated time of the link. There are 2 interfaces attached the switch you check. The **IP address** shows the learnt IP interface of the next hops. And the **Interface** shows the connected local interface.

OSPF Neighbor Table

Neighbor ID	Priority	State	Dead Time	IP Address	Interface
192.168.3.254	1	Full/Backup	00:00:33	192.168.2.253	vlan2:192.168.2.254
192.168.5.254	1	Full/Backup	00:00:38	192.168.5.254	vlan5:192.168.5.253

Reload

State:

Down- initial state of the neighbor conversation - no recent information has been received from the neighbor.

Attempt - no recent information has been received from the neighbor but a more concerted effort should be made to contact the neighbor.

Init - an Hello packet has recently been seen from the neighbor, but bi-directional communication has not yet been established.

2 way - communication between the two routers is bi-directional.

Exchange start - the first step in creating an adjacency between the two neighboring routers, the goal is to decide which router is the master and to decide upon the initial DD sequence number.

Exchange - the router is describing its entire link state database by sending Database Description packets to the neighbor.

Loading - Link State Request packets are sent to the neighbor asking for the more recent LSAs that have been discovered (but not yet received) in the Exchange state.

Full - the neighboring routers are fully adjacent and they will now appear in router-LSAs and network-LSAs.

DR: Designated Router. This indicates the role of the coming interface is a DR.

Backup: Backup Designated Router. This indicates the role of the coming interface is a BDR.

4.9.5.4 OSPF Area Configuration

This page allows user to configure the OSPF Area information.

An OSPF domain is divided into different areas. Areas are logical grouping of hosts and networks, including their routers having interfaces connected to any of the included networks. Each area maintains its own link state database. In OSPF, all areas must be connected to a backbone area. The backbone area is responsible for distributing routing information between non-backbone areas.

The JetNet 6828Gf is usually installed as internal router of a single Area environment. While there are multiple areas in the network, this page allows modify the Area information and Virtual Link.

Area: This field indicates the area ID. Select the ID you want to modify here.

Default Cost: The default cost of the area ID.

Shortcut: No Defined, Disable, Enable. This indicates whether the area is the **OSPF ABR shortcut** mode.

Stub: Represents whether the specified Area is a stub area or not. The possible values are No Defined, No Summary and Summary. Summary is used to advertise summary routes.

Virtual Link (A.B.C.D.): You can configure the virtual link. One area must be common area between two endpoint routers to create virtual links.

OSPF Area Configuration

Area	Default Cost	Shortcut	Stub
0.0.0.1	1	No Defined	No Defined

- No Defined
- No Summary
- Summary

Apply **Remove** **Reload**

Range (A.B.C.D/M)

Add **Remove**

Virtual Link (A.B.C.D)

Add **Remove**

Once you finish configuring the settings, click on **Apply** or **Add** to apply your configuration.

4.9.6 Multicast Route

JetNet 6828G supports both the IP Multicast Filtering and the IP Multicast Routing features.

The IP Multicast is a more efficient way to use network resource, it enables a host (source) to send packets to a group of hosts (clients) with the same multicast destination address. In layer 2 switch, we use IGMP Snooping (described in chapter 4.7) to snoop the destination MAC address of the multicast stream and registered to the IGMP table.

In layer 3 switch, it supports full IGMP feature, not only snooping the MAC address of multicast group, but also decide whether the stream can be forwarded to the network or not. If the multicast stream comes from different network, then the Multicast Routing protocol is requested.

Below figure shows the difference between the IGMP and the Multicast Routing protocol. A layer 3 router/switch acts as the boundary router between the 2 types multicast services.

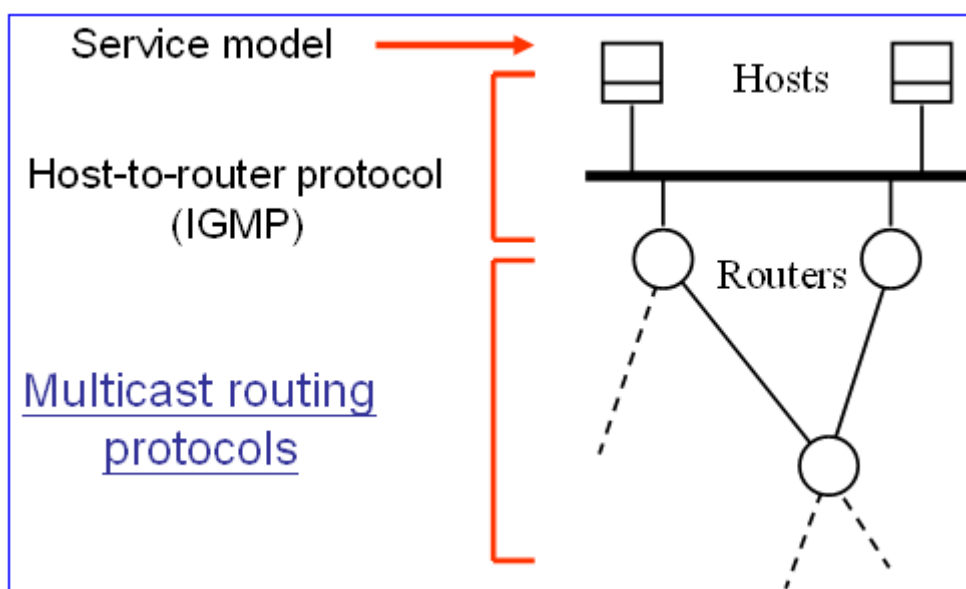

The typical Multicast Routing includes 2 types, one is Distance Vector based, like the DVMRP and PIM/DM. Another is Sparse Mode, like the PIM/SM.

In JetNet 6828G latest firmware release, it only supports the static multicast routing. DVMRP, PIM-DM and the PIM/SM will be supported in later firmware. Please check Korenix News and Web site for future update.

4.9.6.1 MRoute (Multicast Route Configuration for Local IP Multicast Routing)

The MRoute (Multicast Route Configuration) is a feature for multicast routing within the same switch. While there are multiple Multicast streams from different local IP networks need to be routed, enable the MRoute feature can route the multicast streams among the local IP networks.

The MRoute is a previous version before the Multicast Routing protocol launched. The MRoute supports multicast routing within the same switch, there is no protocol information between different switches. However, the multicast routing protocol, DMVRP for example, can exchange multicast protocol's information, learn the networks from other DVMRP-aware switches and routes IP multicast among the while networks.

While configure the Multicast Route Configuration, please Enable the Multicast Route and configure the Network Addresses. After the networks are added, the network can route the IP Multicast streams from different local IP network within the switch.

Multicast Route Configuration

Multicast Route

Routing for Networks

Network Address (A.B.C.D/M)

Status	Uptime	Network Address	Next Hop	Interface	Metric	Expires
connected	00:00:11	192.168.10.0/24	192.168.10.10	vlan1	0	00:00:00

Multicast Route: **Enable** or **Disable** the Multicast Route configuration.

Routing for Networks: Type the Network Address and its netmask. All the IP networks should be added in the MRoute configuration.

Click **“Add”** to add it. Then the entry is displayed in the local MRoute table.

4.9.6.2 Multicast Route Table

The Multicast Route Table is a list to display the Multicast Routing Table of the switch.

Status:

The field indicates the status of the entry. There are 4 flags, Forwarding, Negative, Delete and Pruned.

Time: The active timer of the entry.

Multicast Group: The Multicast Group IP address of the stream.

Source IP: The source IP address of the stream.

Interface: The interface name of the source IP.

Life: The timer is decreased continuously. After the life timer is timeout, the entry will be deleted and the DVMRP probe will be generated again to add new Multicast route entry.

Hold: The entry will be held for a period of time until delete it. The default value is 210 seconds. After the timer timeout, the entry will be deleted and the DVMRP protocol prune

Downstream: The VLAN interface of the downstream.

4.9.7 VRRP

The VRRP represent for the Virtual Router Redundancy Protocol.

To further ensure the high reliability of an environment, the JetNet Layer 3 switch supports the VRRP protocol allowing the hosts to continuously direct traffic to the default gateway without the default gateway configuration change.

The figure for example, there are 3 VRRP-aware switches with the same Virtual IP of the VRRP, but different IP address of their VLAN/IP interface. One is

selected as the VRRP Master and the others are VRRP Backup. The client PCs has the same gateway IP which is the virtual IP of the 3 switches. Once the VRRP Master switch or the VLAN interface failure, the VRRP Backup switch will act as the new Master immediately, thus the communication from the client PC will not stop.

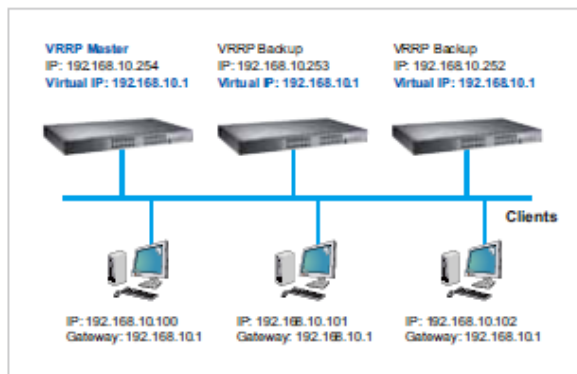

Virtual Router Interface

The fields allow you to create the Virtual Router Interface. All the layer 3 switches within the same VRRP domain should be located within the same IP network and equipped with the same Virtual ID and Virtual IP address.

Interface: Select the interface for the VRRP domain.

Virtual ID: This is a virtual ID range from 1~255. The switches within the same VRRP domain should have the same Virtual ID.

Virtual IP: This is the virtual IP of the VRRP domain. This is the Gateway IP of the clients.

Click "Add" once you finish the configuration. Then you can see the entry is created in the Virtual Router Interface Configuration page

VRRP Configuration

Virtual Router Interface

Interface	Virtual ID	Virtual IP
vlan1 ▼	1	192.168.10.1

Virtual Router Interface Configuration

After the VRRP interface is created, you can see the new entry and adjust the settings to decide the policy of the VRRP domain.

Interface: Select the interface for the VRRP domain.

Virtual ID: This is a virtual ID range from 1~255. The switches within the same VRRP domain should have the same Virtual ID.

Virtual IP: This is the virtual IP of the VRRP domain. This is the Gateway IP of the clients.

Priority: The priority of the entry of this switch. In VRRP domain, the VRRP switches must have the same Virtual ID and Virtual IP settings and choose who should be the VRRP Master switch. The switch equips with the highest priority will be selected as the VRRP master. The priority setting field can be manually changed, the range is from 1~254, 255 for virtual IP owner and 100 for backup by default.

Adv. Interval: This field indicates how often the VRRP switches exchange the VRRP settings.

Preempt: While the VRRP Master link is failure, the VRRP Backup will take over its job immediately. However, while the VRRP master link is recovered, who should be the Master? The Preempt decide whether the VRRP master should be recovered or not.

While the Preempt is **Enabled** and the interface is VRRP Master, the interface will be recovered.

While the Preempt is **Disabled** and the interface is VRRP Master, there is no change while the link is recovered. The VRRP backup acts as the Master before restart the switches.

Click **“Apply”** to change the setting. **“Remove”** to remove the entry. **“Reload”** to reload the new entry and settings.

Virtual Router Interface Configuration

Interface	Virtual ID	Virtual IP	Priority	Adv. Interval	Preempt
vlan1	1	192.168.10.1	100	1	Enable

Enable

Disable

Apply Remove Reload

Virtual Router Status

This page displays the Virtual Router Status of the switch. You can see the related VRRP information after the VRRP switches exchanging information.

Virtual Router Status

Interface	VRID	Priority	Time	Owner	Preemption	State	Master IP address	Virtual IP address
vlan1	1	100	3.609	-	Enabled	Master	192.168.10.1	192.168.10.1

Reload

4.9.8 CLI Commands of the Routing Feature

Command Lines of the Routing configuration

Feature	Command Line
ARP	
Age Time	Switch(config)# arp aging-time <10-21600> seconds (10-21600) Switch(config)# arp aging-time 1200 (20min for example)
Static ARP Entry	Switch(config)# arp A.B.C.D IP address of ARP entry aging-time Aging Time Switch(config)# arp 192.168.100.1 MACADDR 48-bit hardware address of ARP entry Switch(config)# arp 192.168.100.1 0012-7712-3456 IFNAME L3 interface Switch(config)# arp 192.168.100.1 0012-7712-3456 fa1 PORT L2 port Switch(config)# arp 192.168.100.1 0012-7712-3456 vlan2 fa1 => The MAC address 0012-7712-3456 with IP 192.168.100.1 is bind to the port 1 of VLAN 2.
ARP Table	Switch# show arp IP address Mac Address Port Vlan Age(min) Type ----- 192.168.10.111 000f.b079.ca3b gi28 1 0 Dynamic
ARP Table Status	Switch# show arp status Age Time (secs) : 9600 ARP entry count : 1 ARP static entry count : 0 ARP dynamic entry count : 1
IP	
Global IP Routing Configuration	Switch(config)# ip routing <cr>
Stop IP Routing	Switch(config)# no ip routing <cr> Note: After enabling the command, the networks of routing protocol will be deleted automatically.
IP Interface Configuration	
Go to the VLAN Interface	Switch(config)# interface vlan 1 Switch(config-if)#
Create IP Address	Switch(config-if)# ip address A.B.C.D/M IP address (e.g. 10.0.0.1/8) Switch(config-if)# ip address 192.168.10.43/24
Create Secondary IP Address	Switch(config-if)# ip address 192.168.101.43/24 secondary
Change Interface to DOWN	Switch(config-if)# shutdown <cr> Switch(config-if)# shutdown

	Interface vlan1 Change to DOWN
Activate the IP Interface	Switch(config-if)# no shutdown arping for the MAC arp: SIOCDARP(pub): No such file or directory ARPING to 192.168.10.254 from 192.168.10.43 via vlan1 Sent 3 probe(s) (3 broadcast(s)) Received 0 reply (0 request(s), 0 broadcast(s)) Interface vlan1 Change to UP
Show ip routing status	Switch# show ip routing IP routing is on
Show ip interface	Switch# show running-config ! interface vlan1 ip address 192.168.10.43/24 ip address 192.168.101.43/24 secondary ip address 192.168.11.1/24 secondary no shutdown ! interface vlan2 ip address 192.168.2.254/24 no shutdown ip igmp ! interface vlan3 ip address 192.168.3.254/23 no shutdown
Router	
Default Route	Switch(config)# ip route 0.0.0.0 0.0.0.0 192.168.100.1 The first 0.0.0.0 means all the unknown networks. The second 0.0.0.0 means all the masks. The last IP address is the IP address of the next hop.
Static Route	Switch# show ip route 192.168.11.0 (static network IP) Routing entry for 192.168.11.0/24 Known via "connected", distance 0, metric 0, best * directly connected, vlan1 Routing entry for 192.168.11.0/24 Known via "static", distance 1, metric 0 192.168.10.254, via vlan1
Show Static/Dynamic Route	Switch# show running-config ! ip route 0.0.0.0/0 192.168.100.1 ip route 192.168.11.0/24 192.168.10.254 !
Routing Table Display	Switch# show ip route Codes: K - kernel route, C - connected, S - static, R - RIP, O - OSPF, B - BGP, > - selected route, * - FIB route O 192.168.2.0/24 [110/40] via 192.168.5.254, vlan5, 00:09:31

	<pre> C>* 192.168.2.0/24 is directly connected, vlan2 O>* 192.168.3.0/24 [110/30] via 192.168.5.254, vlan5, 00:09:31 O>* 192.168.4.0/24 [110/20] via 192.168.5.254, vlan5, 00:09:31 O 192.168.5.0/24 [110/10] is directly connected, vlan5, 00:09:31 C>* 192.168.5.0/24 is directly connected, vlan5 O 192.168.10.0/24 [110/10] is directly connected, vlan1, 00:07:15 C>* 192.168.10.0/24 is directly connected, vlan1 O>* 192.168.12.0/24 [110/40] via 192.168.5.254, vlan5, 00:09:31 O>* 192.168.13.0/24 [110/30] via 192.168.5.254, vlan5, 00:09:31 O>* 192.168.14.0/24 [110/20] via 192.168.5.254, vlan5, 00:09:31 </pre>
RIP (Before enable RIP, the IP Interfaces' setting should be configured and activated first.)	
Enable RIP protocol	<pre> Switch(config)# router rip Switch(config-router)# default-information Control distribution of default route default-metric Set a metric of redistribute routes distance Administrative distance distribute-list Filter networks in routing updates end End current mode and change to enable mode exit Exit current mode and down to previous mode list Print command list neighbor Specify a neighbor router network Enable routing on an IP network no Negate a command or set its defaults offset-list Modify RIP metric passive-interface Suppress routing updates on an interface quit Exit current mode and down to previous mode redistribute Redistribute information from another routing protocol route RIP static route configuration route-map Route map set timers Adjust routing timers version Set routing protocol version </pre>
RIP Version	<pre> Switch(config-router)# version <1-2> version Switch(config-router)# version 2 </pre>
RIP Network	<pre> Switch(config-router)# network 192.168.100.0/24 </pre>
RIP Timer	<pre> Switch(config-router)# timers basic <5-2147483647> Routing table update timer value in second. Default is 30. </pre>
RIP Split Horizon	<pre> Switch(config-router)# passive-interface IFNAME Interface name default default for all interfaces </pre>

	Switch(config-router)# passive-interface default <cr>
RIP default Metric (usually = 1)	Switch(config-router)# default-metric <1-16> Default metric
RIP Setting	Switch# show ip rip status Routing Protocol is "rip" Sending updates every 30 seconds with +/-50%, next due in 23 seconds Timeout after 180 seconds, garbage collect after 120 seconds Outgoing update filter list for all interface is not set Incoming update filter list for all interface is not set Default redistribution metric is 1 Redistributing: Default version control: send version 2, receive version 2 Interface Send Recv Key-chain vlan1 2 2 Routing for Networks: 192.168.10.0/24 192.168.100.0/24 Passive Interface(s): sw0.1 Routing Information Sources: Gateway BadPackets BadRoutes Distance Last Update Distance: (default is 120) =====
	Switch# show running-config ! router rip version 2 network 192.168.10.0/24 network 192.168.100.0/24 passive-interface default
RIP Table	Switch# show ip rip Codes: R - RIP, C - connected, S - Static, O - OSPF, B - BGP Sub-codes: (n) - normal, (s) - static, (d) - default, (r) - redistribute, (i) - interface Network Next Hop Metric From Tag Time C(i) 192.168.10.0/24 0.0.0.0 1 self 0
OSPF (Before enable OSPF, the IP Interfaces' setting should be configured and activated first.)	
Go to the OSPF command line	Switch(config)# router ospf Switch(config-router)# area OSPF area parameters auto-cost Calculate OSPF interface cost according to bandwidth compatible OSPF compatibility list default-information Control distribution of default

	<p>information</p> <p>default-metric Set metric of redistributed routes</p> <p>distance Define an administrative distance</p> <p>distribute-list Filter networks in routing updates</p> <p>end End current mode and change to</p> <p>enable mode</p> <p>exit Exit current mode and down to</p> <p>previous mode</p> <p>list Print command list</p> <p>neighbor Specify neighbor router</p> <p>network Enable routing on an IP network</p> <p>no Negate a command or set its</p> <p>defaults</p> <p>passive-interface Suppress routing updates on an</p> <p>interface</p> <p>quit Exit current mode and down to</p> <p>previous mode</p> <p>redistribute Redistribute information from another</p> <p>routing protocol</p> <p>refresh Adjust refresh parameters</p> <p>router-id router-id for the OSPF process</p> <p>timers Adjust routing timers</p>
Router ID for OSPF	Switch(config-router)# router-id 192.168.3.253
OSPF Network and its Area ID (0.0.0.0 for example)	<p>Switch(config-router)# network 192.168.3.0/24 area</p> <p><0-4294967295> OSPF area ID as a decimal value</p> <p>A.B.C.D OSPF area ID in IP address format</p> <p>Switch(config-router)# network 192.168.3.0/24 area 0.0.0.0</p>
Interface Configuration	
Hello Interface	<p>Switch(config-if)# ip ospf hello-interval</p> <p><1-65535> Seconds</p> <p>Switch(config-if)# ip ospf hello-interval 10</p>
Link Cost Change	<p>Switch(config-if)# ip ospf cost</p> <p><1-65535> Cost</p>
Link Priority	<p>Switch(config-if)# ip ospf priority</p> <p><0-255> Priority</p>
Display	
IP OSPF Information	<p>Switch# show ip ospf</p> <p>OSPF Routing Process, Router ID: 192.168.3.254</p> <p>Supports only single TOS (TOS0) routes</p> <p>This implementation conforms to RFC2328</p> <p>RFC1583Compatibility flag is disabled</p> <p>SPF schedule delay 1 secs, Hold time between two SPF's 1 secs</p> <p>Refresh timer 10 secs</p> <p>Number of external LSA 0</p> <p>Number of areas attached to this router: 1</p> <p>Area ID: 0.0.0.0 (Backbone)</p> <p>Number of interfaces in this area: Total: 3, Active: 3</p> <p>Number of fully adjacent neighbors in this area: 1</p> <p>Area has no authentication</p> <p>SPF algorithm executed 9 times</p> <p>Number of LSA 5</p>
IP OSPF Datasheet	Switch# show ip ospf database

	<pre> OSPF Router with ID (192.168.3.254) Router Link States (Area 0.0.0.0) Link ID ADV Router Age Seq# CkSum Link count 192.168.3.253 192.168.3.253 928 0x80000009 0xf3b2 2 192.168.3.254 192.168.3.254 927 0x8000000a 0xd4aa 3 192.168.5.254 192.168.5.254 230 0x80000006 0xc248 2 Net Link States (Area 0.0.0.0) Link ID ADV Router Age Seq# CkSum 192.168.3.254 192.168.3.254 927 0x80000003 0x7437 192.168.4.253 192.168.5.254 235 0x80000003 0x7334 </pre>
IP OSPF Interface Information	<pre> Switch# show ip ospf interface [IFNAME] Interface name Switch# show ip ospf interface vlan2 vlan2 is up Internet Address 192.168.2.253/24, Area 0.0.0.0 Router ID 192.168.3.253, Network Type BROADCAST, Cost 10 Transmit Delay is 1 sec, State DR, Priority 1 Designated Router (ID) 192.168.3.253, Interface Address 192.168.2.253 No backup designated router on this network Timer intervals configured, Hello 10, Dead 40, Wait 40, Retransmit 5 Hello due in 00:00:02 Neighbor Count is 1, Adjacent neighbor count is 1 </pre>
IP OSPF Neighbor Table	<pre> Switch# show ip ospf neighbor Neighbor ID Pri State Dead Time Address Interface ----- 0.0.0.0 1 Full/DROther 00:00:32 192.168.2.254 vlan2:192.168.2.25 3 </pre>
IP OSPF Networking Routing Table	<pre> Switch# show ip ospf route ===== OSPF network routing table ===== N 192.168.2.0/24 [10] area: 0.0.0.0 directly attached to vlan2 N 192.168.3.0/24 [10] area: 0.0.0.0 directly attached to vlan3 N 192.168.11.0/24 [10] area: 0.0.0.0 directly attached to vlan1 </pre>
OSPF Setting in Configuration file	<pre> Switch# show running-config router ospf router-id 192.168.3.253 network 192.168.2.0/24 area 0.0.0.0 network 192.168.3.0/24 area 0.0.0.0 network 192.168.11.0/24 area 0.0.0.0 ! ip routing </pre>

Multicast Routing (Before enable MRoute, the IP Interfaces' setting should be configured and activated first.)	
Enable the MRoute & Configure the static entry	witch(config)# ip multicast 224.0.1.10 vlan 1 interface gi2-3 vlan specify the ingress VLAN interface specify an interface list to add to IFLIST Interface list, ex: gi1,gi3-4
VRRP (Go to the Interface mode)	
IP of VRRP	Switch(config-if)# vrrp 1 ip 192.168.10.1 The virtual router of vlan1 count is 1. Create virtual router 1 success.
Priority of the interface	Switch(config-if)# vrrp 1 priority <1-254> virtual router's priority value in range 1-254, 255 for virtual IP owner and 100 for backup by default
Preempt of the interface	Switch(config-if)# vrrp 1 preempt Set virtual router preemption mode to enabled success.
VRRP Information	Switch# show vrrp [1-255] virtual router identifier in the range 1-255 (decimal) brief display a summary view of the virtual router information Switch# show vrrp vlan1 - Virtual Router ID 1 State is Master Virtual IP address is 192.168.10.1 Virtual MAC address is 0000.5e00.0101 Priority is 100 Advertisement interval is 1 sec Preemption is enabled Master Router is 192.168.10.1 (local), priority is 100 Master Advertisement interval is 1.000 sec Master Down interval is 3.609 sec
VRRP Brief Information	Switch# show vrrp brief Interface VRID Priority Time Owner Preemption State Master addr Group addr vlan1 1 100 3.609 - enabled Master 192.168.10.1 192.168.10.1

4.10 SNMP

Simple Network Management Protocol (SNMP) is a protocol used for exchanging management information between network devices. SNMP is a member of the TCP/IP protocol suite. *JetNet 6828Gf* series support SNMP v1 and v2c and V3.

An SNMP managed network consists of two main components: agents and a manager. An agent is a management software module that resides in a managed switch. An agent translates the local management information from the managed device into a SNMP compatible format. The manager is the console through the network.

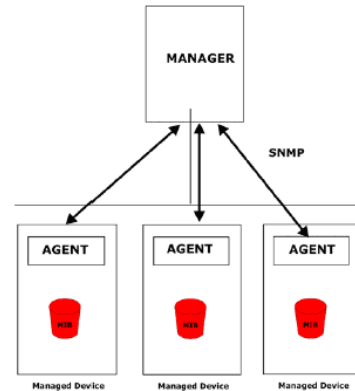

Following commands are included in this group:

4.9.1 SNMP Configuration

4.9.2 SNMP V3 Profile

4.9.3 SNMP Traps

4.9.4 SNMP CLI Commands for SNMP

4.10.1 SNMP Configuration

This page allows users to configure SNMP V1/V2c Community. The community string can be viewed as the password because SNMP V1/V2c doesn't request you to enter password before you try to access SNMP agent.

The community includes 2 privileges, Read Only and Read and Write.

With **Read Only** privilege, you only have the ability to read the values of MIB tables. Default community string is Public.

With **Read and Write** privilege, you have the ability to read and set the values of MIB tables. Default community string is Private.

JetNet 6828Gf allows users to assign 4 community strings. Type the community string and select the privilege. Then press **Apply**.

Note: When you first install the device in your network, we highly recommend you to change the community string. Since most SNMP management application uses Public and Private as their default community name, this might be the leakage of the network security.

SNMP

SNMP V1/V2c Community

Community String	Privilege
public	Read Only ▼
private	Read and Write ▼
	Read Only ▼
	Read Only ▼

Apply

4.10.2 SNMP V3 Profile

SNMP v3 can provide more security functions when the user performs remote management through SNMP protocol. It delivers SNMP information to the administrator with user authentication; all of data between *JetNet 6828Gf* and the administrator are encrypted to ensure secure communication.

SNMP V3 Profile

SNMP V3

User Name	<input type="text"/>
Security Level	Authentication ▼
Authentication Protocol	SHA ▼
Authentication Password	<input type="text"/>
DES Encryption Password	<input type="text"/>

Add

Security Level: Here the user can select the following levels of security: None, User Authentication, and Authentication with privacy.

Authentication Protocol: Here the user can select either MD5 (Message-Digest algorithm 5) or SHA (Secure Hash Algorithm). MD5 is a widely used cryptographic hash function with a 128-bit hash value. SHA (Secure Hash Algorithm) hash functions refer to five Federal Information Processing Standard-approved algorithms for computing a condensed digital representation. *JetNet 6828Gf* provides 2 user authentication protocols in MD5 and SHA. You will need to configure SNMP v3 parameters for your SNMP tool with the same authentication method.

Authentication Password: Here the user enters the SNMP v3 user authentication password.

DES Encryption Password: Here the user enters the password for SNMP v3 user DES

Encryption.

4.10.3 SNMP Traps

SNMP Trap is the notification feature defined by SNMP protocol. All the SNMP management applications can understand such trap information. So you don't need to install new application to read the notification information.

This page allows users to **Enable SNMP Trap**, configure the **SNMP Trap server IP**, **Community** name, and trap **Version V1 or V2**. After configuration, you can see the change of the SNMP pre-defined standard traps and Korenix pre-defined traps. The pre-defined traps can be found in Korenix private MIB.

SNMP Trap

SNMP Trap Enable ▾

Apply

SNMP Trap Server

Server IP	192.168.10.100
Community	private
Version	<input type="radio"/> V1 <input checked="" type="radio"/> V2c

Add

Trap Server Profile

Server IP	Community	Version
192.168.10.33	public	V1

Remove

Reload

4.10.4 CLI Commands of the SNMP

Command Lines of the SNMP configuration

Feature	Command Line
SNMP Community	
Read Only Community	Switch(config)# snmp-server community public ro community string add ok

Read Write Community	Switch(config)# snmp-server community private rw community string add ok
SNMP Trap	
Enable Trap	Switch(config)# snmp-server enable trap Set SNMP trap enable ok.
SNMP Trap Server IP without specific community name	Switch(config)# snmp-server host 192.168.10.33 SNMP trap host add OK.
SNMP Trap Server IP with version 1 and community	Switch(config)# snmp-server host 192.168.10.33 version 1 private SNMP trap host add OK. Note: private is the community name, version 1 is the SNMP version
SNMP Trap Server IP with version 2 and community	Switch(config)# snmp-server host 192.168.10.33 version 2 private SNMP trap host add OK.
Disable SNMP Trap	Switch(config)# no snmp-server enable trap Set SNMP trap disable ok.
Display	Switch# sh snmp-server trap SNMP trap: Enabled SNMP trap community: public Switch# show running-config snmp-server community public ro snmp-server community private rw snmp-server enable trap snmp-server host 192.168.10.33 version 2 admin snmp-server host 192.168.10.33 version 1 admin

4.11 Security

JetNet 6828Gf provides several security features for you to secure your connection. The Filter Set is also known as Access Control List. The ACL feature includes traditional Port Security and IP Security.

Following commands are included in this group:

4.10.1 Filter Set (Access Control List)

4.10.2 IEEE 802.1x

4.10.3 CLI Commands of the Security

4.11.1 Filter Set (Access Control List)

The Filter Set is known as Access Control List feature. There are 2 major types, one is MAC Filter, it is also known as Port Security in other JetNet series. It allows user to define the access rule based on the MAC address flexibility. Another one is IP Filter. It includes the IP security known in other JetNet series, IP Standard access list and advanced IP based access lists.

ACE is short of Access Control Entry, user defines the Permit or Deny rule for specific IP/MAC address or IP groups by network mask in each ACE. One ACL may include several ACEs, the system checks the ACEs one after one and forward based on the result. Once the rules conflict, the old entry is selected as the forward rule.

Type the **Name** when select **MAC Filter**, type **ID/Name** when select **IP Filter**. The ID for IP access list is listed as below of the field. Click **Add** to add the rule. **Delete** to remove one of the entries.

MAC Filter Group

Group Name	Select
------------	--------

MAC Filter (Port Security):

MAC Filter Setting

Group Name	▼
Source MAC	<input type="text"/>
Source Wildcard	any ▼
Destination MAC	<input type="text"/>
Destination Wildcard	any ▼
Egress Port	▼
Action	<input type="radio"/> Permit <input type="radio"/> Deny
<input type="button" value="Add"/>	

MAC Filter List

Group Name	Source MAC	Source Wildcard	Destination MAC	Destination Wildcard	Action	Egress Port	Select
<input type="button" value="Delete"/>							

The MAC Filter allows user to define the Access Control List for specific MAC address or a group of MAC addresses.

Group Name: The name for this MAC Filter entry.

Action: **Permit** to permit traffic from specified sources. **Deny** to deny traffic from those sources.

Source/Destination Address: Type the MAC address you want configure, the format is "AABB.CCDD.EEFF". Example: "Source to Destination" is "0012.7700.0000 to 0012.7700.0002".

Source/Destination Wildcard: This command allows user to define single host or a group of hosts based on the wildcard. Some of the allowance examples are as below:

Wildcard	Bit	Number of allowance	Note
Any	1111.1111.1111	All	
Host		1	Only the Source or Destination.
0000.0000.0003	0000.0000.000(00000011)	3	
0000.0000.0007	0000.0000.000(00000111)	7	
0000.0000.000F	0000.0000.000(11111111)	15	
....			

Source Wildcard:	Any
Egress Port:	Any

Egress Port: Bind the MAC Filter rule to specific front port.

Egress Port:	--
--------------	----

- fastethernet21
- fastethernet22
- fastethernet23
- fastethernet24
- gigabitethernet25
- gigabitethernet26
- gigabitethernet27
- gigabitethernet28

Add **Modify**

Once you finish configuring the ACE settings, click on **Add** to apply your configuration. You can see below screen is shown.

Example of the below Entry:

Permit Source MAC "0012.7700.0000" to Destination MAC "0012.7700.0002".

The Permit rule is egress rule and it is bind to Gigabit Ethernet Port 25.

Source / Wildcard	Destination / Wildcard	Action	Egress Port
0012.7700.0000 / 0000.0000.0001	0012.7700.0002 / 0000.0000.0001	Permit	gigabitethernet25

Apply **Reload**

Once you finish configuring the settings, click on **Apply** to apply your configuration.

IP Filter:

Type **ID**, 1~99 for IP Standard AccessList, 100~100 for IP Extended Access List, 1300~1999 for expanded IP Standard Access List, 2000~2600 for expanded IP Extended Access List. Then click **Add** to add this filter. Select a entry then click **Remove** to remove a filter entry.

Example:

IP Filter Group

(1-99) IP Standard Access List

(100-199) IP Extended Access List

(1300-1999) IP Standard Access List (expanded range)

(2000-2699) IP Standard Access List (expanded range)

Add

Group Number	Type	Select
123	Extended	<input type="checkbox"/>

Remove

Refresh

IP Standard Access List: This kind of ACL allows user to define filter rules according to the source IP address.

IP Extended Access List: This kind of ACL allows user to define filter rules according to the source IP address, destination IP address, Source TCP/UDP port, destination TCP/UDP port and ICMP.

Click **Add** to configure the IP Filter Rules.

IP Filter Setting

Group Number	123 ▾
Source IP	<input type="text"/>
Source Wildcard	any ▾
Destination IP	<input type="text"/>
Destination Wildcard	any ▾
Protocol	IP ▾
Egress Port	▾
Action	<input checked="" type="radio"/> Permit <input type="radio"/> Deny
Add	<input type="button" value="Add"/>

IP Filter List

Group Number	Type	Source IP	Source Wildcard	Destination IP	Destination Wildcard	Protocol	Action	Egress Port	Select
123		any	any	any	any	icmp	deny		<input type="checkbox"/>

Remove

Group Number: The ID or the name for this IP Filter entry.

Action: **Permit** to permit traffic from specified sources. **Deny** to deny traffic from those sources.

Source IP: Type the source IP address you want configure.

Destination IP: Type the destination IP address you want configure.

Source and Destination Wildcard: This command allows user to define single host or a group of hosts based on the wildcard. Some of the allowance examples are as below:

Wildcard	Bit	Number of allowance	Note
Any	11111111.11111111. 11111111.11111111	All	All IP addresses. Or a mask: 255.255.255.255
Host	0.0.0.0	1	Only the Source or Destination host.
0.0.0.3	0.0.0.(00000011)	3	
0.0.0.7	0.0.0.(00000111)	7	
0.0.0.15	0.0.0.(11111111)	15	
....			

Note: The mask is a wildcard mask: the high-order bits of the mask that are binary zeros determine how many corresponding high-order bits in the IP address are significant. The selected action applies to any source address with these high-order bits.

Protocol: Select a protocol you want associate with the filter. The field includes IP, TCP, UDP or ICMP type.

Click the **Add** button to add the rule to the Filter. Click the **Remove** button to remove the selected rule from Filter.

Filter Attach

Port	Port 1 ▼
MAC Filter	-- ▼
IP Filter	-- ▼

Apply

Filter Attach List

Port	MAC Filter	IP Filter
1		123
2		
3		
4		
5		
6		
7		
8		
9		
10		
11		
12		
13		
14		
15		

After configured the ACL filter rules, remember associate this filter with the physical ports. Then the port has the capability to filter traffic/attach based on the packets lost.

4.11.2 IEEE 802.1x

4.10.3.1 802.1X configuration

IEEE 802.1X is the protocol that performing authentication to obtain access to IEEE 802 LANs. It is port-base network access control. With the function, JetNet 6828Gf could control which connection is available or not.

802.1x Port-Based Network Access Control Configuration

System Auth Control

Authentication Method

RADIUS Server

RADIUS Server IP	<input type="text" value="192.168.10.100"/>
Shared Key	<input type="text" value="radius-key"/>
Server Port	<input type="text" value="1812"/>
Accounting Port	<input type="text" value="1813"/>

Secondary RADIUS Server

RADIUS Server IP	<input type="text"/>
Shared Key	<input type="text"/>
Server Port	<input type="text"/>
Accounting Port	<input type="text"/>

Local RADIUS User

Username	Password	VID
<input type="text"/>	<input type="text"/>	<input type="text"/>

Local RADIUS User List

Username	Password	VID

System AuthControl: To enable or disable the 802.1x authentication.

Authentication Method: Radius is a authentication server that provide key for authentication, with this method, user must connect switch to server. If user select Local for the authentication method, switch use the local user data base which can be create in this page for authentication.

Radius Server IP: The IP address of Radius server

Shared Key: The password for communicate between switch and Radius Server.

Server Port: UDP port of Radius server.

Accounting Port: Port for packets that contain the information of account login or logout.

Secondary Radius Server IP: Secondary Radius Server could be set in case of the

primary radius server down.

Local Radius User: Here User can add Account/Password for local authentication.

Local Radius User List: This is a list shows the account information, User also can remove selected account Here.

4.10.3.2 802.1x Port Configuration

After the configuration of Radius Server or Local user list, user also need configure the authentication mode, authentication behavior, applied VLAN for each port and permitted communication. The following information will explain the port configuration.

802.1x Port-Based Network Access Control Port Configuration

802.1x Port Configuration

Port	Port Control	Reauthentication	Max Request	Guest VLAN	Host Mode	Admin Control Direction
1	Force Authorized	Disable	2	0	Single	Both
2	Force Authorized	Disable	2	0	Single	Both
3	Force Authorized	Disable	2	0	Single	Both
4	Force Authorized	Disable	2	0	Single	Both
5	Force Authorized	Disable	2	0	Single	Both
6	Force Authorized	Disable	2	0	Single	Both

802.1x Timeout Configuration

Port	Re-Auth Period(s)	Quiet Period(s)	Tx Period(s)	Supplicant Timeout(s)	Server Timeout(s)
1	3600	60	30	30	30
2	3600	60	30	30	30
3	3600	60	30	30	30
4	3600	60	30	30	30
5	3600	60	30	30	30
6	3600	60	30	30	30

Once you finish configuring the settings, click on **Apply** to apply your configuration.

Port control: Force Authorized means this port is authorized; the data is free to in/out. Force unauthorized just opposite, the port is blocked. If users want to control this port with Radius Server, please select Auto for port control.

Reauthentication: If enable this field, switch will ask client to re-authenticate. The default time interval is 3600 seconds.

Max Request: the maximum times that the switch allow client request.

Guest VLAN: 0 to 4094 is available for this field. If this field is set to 0, that means the port is blocked after authentication fail. Otherwise, the port will be set to Guest VLAN.

Host Mode: if there are more than one device connected to this port, set the Host Mode to single means only the first PC authenticate success can access this port. If this port is set to multi, all the device can access this port once any one of them pass the authentication.

Control Direction: determined devices can end data out only or both send and receive.

Re-Auth Period: control the Re-authentication time interval, 1~65535 is available.

Quiet Period: When authentication failed, Switch will wait for a period and try to communicate with radius server again.

Tx period: the time interval of authentication request.

Supplicant Timeout: the timeout for the client authenticating

Sever Timeout: The timeout for server response for authenticating.

Click **Initialize Selected** to set the authorize state of selected port to initialize status.

Click **Reauthenticate Selected** to send EAP Request to supplicant to request re-authentication.

Click **Default Selected** to reset the configurable 802.1x parameters of selected port to the default values.

802.1X Port Status

Here user can observe the port status for Port control status, Authorize Status, Authorized Supplicant and Oper Control Direction each port.

802.1x Port-Based Network Access Control Port Status

Port	Port Control	Authorize Status	Authorized Supplicant	Oper Control Direction
1	Force Authorized	AUTHORIZED	NONE	Both
2	Force Authorized	AUTHORIZED	NONE	Both
3	Force Authorized	AUTHORIZED	NONE	Both
4	Force Authorized	AUTHORIZED	NONE	Both
5	Force Authorized	AUTHORIZED	NONE	Both
6	Force Authorized	AUTHORIZED	NONE	Both
7	Force Authorized	AUTHORIZED	NONE	Both
8	Force Authorized	AUTHORIZED	NONE	Both
9	Force Authorized	AUTHORIZED	NONE	Both
10	Force Authorized	AUTHORIZED	NONE	Both

Reload

4.11.3 CLI Commands of the Security

Command Lines of the Security configuration

Feature	Command Line
Port Security	
Add MAC access list	<pre>Switch(config)# mac access-list extended NAME access-list name Switch(config)# mac access-list extended server1 Switch(config-ext-macl)# permit Specify packets to forward deny Specify packets to reject end End current mode and change to enable mode exit Exit current mode and down to previous mode list Print command list no Negate a command or set its defaults quit Exit current mode and down to previous mode</pre>
Add IP Standard access list	<pre>Switch(config)# ip access-list extended Extended access-list standard Standard access-list Switch(config)# ip access-list standard <1-99> Standard IP access-list number <1300-1999> Standard IP access-list number (expanded range) WORD Access-list name Switch(config)# ip access-list standard 1 Switch(config-std-acl)# deny Specify packets to reject permit Specify packets to forward end End current mode and change to enable mode exit Exit current mode and down to previous mode list Print command list no Negate a command or set its defaults quit Exit current mode and down to previous mode remark Access list entry comment</pre>
Add IP Extended access list	<pre>Switch(config)# ip access-list extended <100-199> Extended IP access-list number <2000-2699> Extended IP access-list number (expanded range) WORD access-list name Switch(config)# ip access-list extended 100 Switch(config-ext-acl)# deny Specify packets to reject permit Specify packets to forward end End current mode and down to previous mode exit Exit current mode and down to previous mode list Print command list no Negate a command or set its defaults quit Exit current mode and down to previous mode remark Access list entry comment</pre>
Example 1: Edit MAC access list	<pre>Switch(config-ext-macl)#permit MACADDR Source MAC address xxxx.xxxx.xxxx any any source MAC address host A single source host Switch(config-ext-macl)#permit host MACADDR Source MAC address xxxx.xxxx.xxxx Switch(config-ext-macl)#permit host 0012.7711.2233 MACADDR Destination MAC address xxxx.xxxx.xxxx any any destination MAC address</pre>

	<p>host A single destination host</p> <pre>Switch(config-ext-macl)#permit host 0012.7711.2233 host MACADDR Destination MAC address xxxx.xxxx.xxxx Switch(config-ext-macl)#permit host 0012.7711.2233 host 0011.7711.2234</pre> <p><i>Note: MAC Rule: Permit/Deny wildcard Source_MAC wildcard Dest_MAC Egress_Interface</i></p>
Example 1: Edit IP Extended access list	<pre>Switch(config)# ip access-list extended 100 Switch(config-ext-acl)#permit ip Any Internet Protocol tcp Transmission Control Protocol udp User Datagram Protocol icmp Internet Control Message Protocol Switch(config-ext-acl)#permit ip A.B.C.D Source address any Any source host host A single source host Switch(config-ext-acl)#permit ip 192.168.10.1 A.B.C.D Source wildcard bits Switch(config-ext-acl)#permit ip 192.168.10.1 0.0.0.1 A.B.C.D Destination address any Any destination host host A single destination host Switch(config-ext-acl)#permit ip 192.168.10.1 0.0.0.1 192.168.10.100 0.0.0.1</pre>
Add MAC	<pre>Switch(config)# mac-address-table static 0012.7701.0101 vlan 1 interface fa1 mac-address-table unicast static set ok!</pre>
Port Security	<pre>Switch(config)# interface fa1 Switch(config-if)# switchport port-security Disables new MAC addresses learning and aging activities!</pre> <p>Note: Rule: Add the static MAC, VLAN and Port binding first, then enable the port security to stop new MAC learning.</p>
Disable Port Security	<pre>Switch(config-if)# no switchport port-security Enable new MAC addresses learning and aging activities!</pre>
Display	<pre>Switch# show mac-address-table static Destination Address Address Type Vlan Destination Port ----- 0012.7701.0101 Static 1 fa1</pre>
802.1x (shot of dot1x)	
enable	<pre>Switch(config)# dot1x system-auth-control Switch(config)#</pre>
diabile	<pre>Switch(config)# no dot1x system-auth-control Switch(config)#</pre>
authentic-method	<pre>Switch(config)# dot1x authentic-method local Use the local username database for authentication radius Use the Remote Authentication Dial-In User Service (RADIUS) servers for authentication Switch(config)# dot1x authentic-method radius Switch(config)#</pre>

radius server-ip	<pre>Switch(config)# dot1x radius Switch(config)# dot1x radius server-ip 192.168.10.120 key 1234 RADIUS Server Port number NOT given. (default=1812) RADIUS Accounting Port number NOT given. (default=1813) RADIUS Server IP : 192.168.10.120 RADIUS Server Key : 1234 RADIUS Server Port : 1812 RADIUS Accounting Port : 1813 Switch(config)#</pre>
radius server-ip	<pre>Switch(config)# dot1x radius Switch(config)# dot1x radius server-ip 192.168.10.120 key 1234 RADIUS Server Port number NOT given. (default=1812) RADIUS Accounting Port number NOT given. (default=1813) RADIUS Server IP : 192.168.10.120 RADIUS Server Key : 1234 RADIUS Server Port : 1812 RADIUS Accounting Port : 1813 Switch(config)#</pre>
radius secondary-server-ip	<pre>Switch(config)# dot1x radius secondary-server-ip 192.168.10.250 key 5678 Port number NOT given. (default=1812) RADIUS Accounting Port number NOT given. (default=1813) Secondary RADIUS Server IP : 192.168.10.250 Secondary RADIUS Server Key : 5678 Secondary RADIUS Server Port : 1812 Secondary RADIUS Accounting Port : 1813</pre>
User name/password for authentication	<pre>Switch(config)# dot1x userna orenixnix pass orenixnix vlan 1</pre>
Display	<pre>Switch# show dot1x <cr> all Show Dot1x information for all interface authentic-method Dot1x authentic-method interface Interface name radius Remote Access Dial-In User Service statistics Interface name username User Name in local radius database Switch# show dot1x <cr> = Switch# show dot1x all You can check all dot1x information for all interfaces. Click Ctrl + C to exit the display Switch# show dot1x interface fa1 Supplicant MAC ADDR <NONE> STATE-MACHINE AM status : FORCE_AUTH BM status : IDLE PortStatus : AUTHORIZED PortControl : Force Authorized Reauthentication : Disable MaxReq : 2</pre>

```
ReAuthPeriod      : 3600 Seconds
QuietPeriod       : 60 Seconds
TxPeriod          : 30 Seconds
SupplicantTimeout : 30 Seconds
ServerTimeout     : 30 Seconds
GuestVlan         : 0
HostMode          : Single
operControlledDirections : Both
adminControlledDirections : Both

Switch# show dot1x radius
RADIUS Server IP   : 192.168.10.100
RADIUS Server Key  : radius-key
RADIUS Server Port : 1812
RADIUS Accounting Port : 1813
Secondary RADIUS Server IP   : N/A
Secondary RADIUS Server Key  : N/A
Secondary RADIUS Server Port : N/A
Secondary RADIUS Accounting Port : N/A

Switch# show dot1x username
802.1x Local User List
  Username : orwell , Password : * , VLAN ID : 1
```

4.12 Warning

JetNet 6828Gf provides several types of Warning features for you to remote monitor the status of end devices or the change of your network. The features include System Log and SMTP E-mail Alert.

Following commands are included in this group:

- 4.11.1 Fault Relay
- 4.11.2 Event Selection
- 4.11.3 Syslog Configuration
- 4.11.4 SMTP Configuration
- 4.11.5 CLI Commands

4.12.1 Fault Relay

The Switch provides 1 digital output, also known as Relay Output or Fault Relay. The relay contacts are energized (open) for normal operation and will close when fault event occurred. The fault event types includes Power, Port Link down, Ring failure, specified IP address ping failure, DI State change or perform a period of on/off. Each Fault Relay could be trigger by several of events, not only one.

Fault Relay

Relay 1	Status is Off		
<input type="checkbox"/> Port Link	Port	<input type="checkbox"/> 1 <input type="checkbox"/> 2 <input type="checkbox"/> 3 <input type="checkbox"/> 4 <input type="checkbox"/> 5 <input type="checkbox"/> 6 <input type="checkbox"/> 7 <input type="checkbox"/> 8 <input type="checkbox"/> 9 <input type="checkbox"/> 10	
		<input type="checkbox"/> 11 <input type="checkbox"/> 12 <input type="checkbox"/> 13 <input type="checkbox"/> 14 <input type="checkbox"/> 15 <input type="checkbox"/> 16 <input type="checkbox"/> 17 <input type="checkbox"/> 18 <input type="checkbox"/> 19 <input type="checkbox"/> 20	
		<input type="checkbox"/> 21 <input type="checkbox"/> 22 <input type="checkbox"/> 23 <input type="checkbox"/> 24 <input type="checkbox"/> 25 <input type="checkbox"/> 26 <input type="checkbox"/> 27 <input type="checkbox"/> 28	
<input type="checkbox"/> Ring	Ring Failure		
<input type="checkbox"/> Ping	IP Address	<input type="text"/>	
<input type="checkbox"/> Ping Reset	IP Address	Reset Time(Sec)	Hold Time(Sec)
<input type="checkbox"/> Dry Output	On Period(Sec)	<input type="text"/>	Off Period(Sec) <input type="text"/>

Dry Output:

On Period (Sec): Type the period time to turn on Relay Output. Available range of a period is 0-4294967295 seconds.

Off Period (Sec): Type the period time to turn off Relay Output. Available range of a period is 0-4294967295 seconds.

Ping Failure:

IP Address: IP address of the target device you want to ping.

Reset Time (Sec): Waiting time to short the relay output.

Hold Time (Sec): Waiting time to ping the target device for the duration of remote device boot

How to configure: After selecting Ping Failure event type, the system will turn Relay Output

to short state and continuously ping the target device. When the ping failure occurred, the switch will turn the Relay Output to open state for a period of Reset Time.

After the Reset Time timeout, the system will turn the Relay Output to close state. After the Hold Time timer is timeout, the switch system will start ping the target device.

Ex: Reset Time is 5 sec, Hold Time is 50 sec.

If the ping failure occurred, the switch system will turn Relay output to open state to emulate power switch off for 5 sec periods. After Reset Time timeout, the Switch system will start ping target device after 50 sec periods. The period time is for target device system booting. During the period, the switch system will not ping target device until Hold Time is timeout.

Ring:

Select Ring Failure. When the Ring topology is changed, the system will short Relay Out and lengthen DO LED.

Once you finish configuring the settings, click on **Apply** to apply your configuration.

4.12.2 Event Selection

Event Types can be divided into two basic groups: System Events and Port Events. System Events are related to the overall function of the switch, whereas Port Events related to the activity of a specific ports

Warning - Event Selection

System Event Selection

- Device Cold Start
- Device Warm Start
- Authentication Failure
- Time Synchronize Failure
- Ring Event
- Relay1
- SFP
- Power Failure AC1 AC2

Port Event Selection

Port	Link State
1	Disable
2	Disable
3	Disable
4	Disable
5	Disable
6	Disable
7	Disable
8	Disable
9	Disable
10	Disable

Apply

System Event	Warning Event is sent when.....
Device Cold Start	Power is cut off and then reconnected.
Device Warm Start	Reboot the device by CLI or Web UI.
Authentication failure	An incorrect password, SNMP Community String is entered.
Time Synchronize Failure	Accessing to NTP Server is failure.
Ring	If ring topology changed
Ping Reset	Ping target device and trigger relay to emulate power reset for remote device, if remote system crash. Note: once perform Ping reset, the relay output will form a short circuit.
Dry Output	Relay continuous perform On/Off behavior with different duration.
Power Failure	Power Failure when AC/DC power error.
Port Event	Warning Event is sent when.....
Link-Up	The port is connected to another device
Link-Down	The port is disconnected (e.g. the cable is pulled out, or the opposing devices turns down)

Once you finish configuring the settings, click on **Apply** to apply your configuration.

4.12.3 SysLog Configuration

System Log is useful to provide system administrator locally or remotely monitor switch events history. There are 2 System Log modes provided by *JetNet 6828Gf*, local mode and remote mode.

Local Mode: In this mode, *JetNet 6828Gf* will print the occurred events selected in the Event Selection page to System Log table of *JetNet 6828Gf*. You can monitor the system logs in [Monitor and Diag] / [Event Log] page.

Remote Mode: The remote mode is also known as Server mode in *JetNet 4500* series. In this mode, you should assign the IP address of the System Log server. *JetNet 6828Gf* will send the occurred events selected in Event Selection page to System Log server you assigned.

Both: Above 2 modes can be enabled at the same time.

Warning - SysLog Configuration

Syslog Mode	Both
Remote IP Address	Disable Local Remote Both

Note: When enabled Local or Remote mode, you can monitor the system logs in the [Monitor and Diag] / [Event Log] page.

Apply

Once you finish configuring the settings, click on **Apply** to apply your configuration.

Note: When enabling Local or Both mode, you can monitor the system logs in [Monitor and Diag] / [Event Log] page.

4.12.4 SMTP Configuration

JetNet 6828Gf supports E-mail Warning feature. The switch will send the occurred events to remote E-mail server. The receiver can then receive notification by E-mail. The E-mail warning is conformed to SMTP standard.

This page allows you to enable E-mail Alert, assign the SMTP Server IP, Sender E-mail, and Receiver E-mail. If SMTP server requests you to authorize first, you can also set up the username and password in this page.

Warning - SMTP Configuration

E-mail Alert

SMTP Configuration

SMTP Server IP	192.168.10.1
Mail Account	admin@korenix.com
<input type="checkbox"/> Authentication	
User Name	
Password	
Confirm Password	
Rcpt E-mail Address 1	korecare@korenix.com
Rcpt E-mail Address 2	
Rcpt E-mail Address 3	
Rcpt E-mail Address 4	

Apply

Field	Description
SMTP Server IP Address	Enter the IP address of the email Server
Authentication	Click on check box to enable password

User Name	Enter email Account name (Max.40 characters)
Password	Enter the password of the email account
Confirm Password	Re-type the password of the email account
You can set up to 4 email addresses to receive email alarm from JetNet	
Rcpt E-mail Address 1	The first email address to receive email alert from JetNet (Max. 40 characters)
Rcpt E-mail Address 2	The second email address to receive email alert from JetNet (Max. 40 characters)
Rcpt E-mail Address 3	The third email address to receive email alert from JetNet (Max. 40 characters)
Rcpt E-mail Address 4	The fourth email address to receive email alert from JetNet (Max. 40 characters)

Once you finish configuring the settings, click on **Apply** to apply your configuration.

4.12.5 CLI Commands

Command Lines of the Warning configuration

Feature	Command Line
Relay Output	
Relay Output	Switch(config)# relay 1 dry dry output ping ping failure port port link failure ring ring failure
Dry Output	Switch(config)# relay 1 dry <0-65535> turn on period in second Switch(config)# relay 1 dry 5 <0-65535> turn off period in second Switch(config)# relay 1 dry 5 5
Ping Failure	Switch(config)# relay 1 ping 192.168.10.33 <cr> reset reset a device Switch(config)# relay 1 ping 192.168.10.33 reset <1-65535> reset time Switch(config)# relay 1 ping 192.168.10.33 reset 60 <0-65535> hold time to retry Switch(config)# relay 1 ping 192.168.10.33 reset 60 60
Port Link Failure	Switch(config)# relay 1 port PORTLIST Port list, ex: fa1,fa3-5,gi17-20 Switch(config)# relay 1 port fa1-5
Ring Failure	Switch(config)# relay 1 ring
Disable Relay	Switch(config)# no relay 1 relay id Switch(config)# no relay 1
Display	Switch# show relay 1 Relay 1

	<p>Event :</p> <ul style="list-style-type: none"> Power : Disabled Port Link : Disabled Ring : Disabled Ping : Disabled Ping Reset : Disabled Dry Output : Disabled DI : Disabled
Event Selection	
Event Selection	<pre>Switch(config)# warning-event coldstart Switch cold start event warmstart Switch warm start event authentication Authentication failure event linkdown Switch link down event linkup Switch link up event authentication Authentication failure event ring Switch ring event fault-relay Switch fault relay event time-sync Switch time synchronize event sfp Switch SFP event loop-protect Switch loop protection event</pre>
Ex: Cold Start event	<pre>Switch(config)# warning-event coldstart Set cold start event enable ok.</pre>
Ex: Link Up event	<pre>Switch(config)# warning-event linkup [IFNAME] Interface name, ex: fastethernet1 or gi8 Switch(config)# warning-event linkup fa5 Set fa5 link up event enable ok.</pre>
Display	<pre>Switch# show warning-event Warning Event: Cold Start: Disabled Warm Start: Disabled Authentication Failure: Disabled Link Down: Disabled Link Up: Disabled Ring: Disabled Fault Relay: Disabled Time Synchronize Failure: Disabled SFP: Disabled Loop Protection: Disabled</pre>
Syslog Configuration	
Local Mode	Switch(config)# log syslog local
Server Mode	Switch(config)# log syslog remote 192.168.10.33
Both	<pre>Switch(config)# log syslog local Switch(config)# log syslog remote 192.168.10.33</pre>
Disable	Switch(config)# no log syslog local
SMTP Configuration	
SMTP Enable	<pre>Switch(config)# smtp-server enable email-alert SMTP Email Alert set enable ok.</pre>
Sender mail	<pre>Switch(config)# smtp-server server 192.168.10.100 ACCOUNT SMTP server mail account, ex: admin@korenix.com Switch(config)# smtp-server server 192.168.10.100 admin@korenix.com SMTP Email Alert set Server: 192.168.10.100, Account: admin@korenix.com ok.</pre>

Receiver mail	Switch(config)# smtp-server receipt admin@example.com SMTP Email Alert set receipt 1: admin@example.com ok.
Authentication with username and password	Switch(config)# smtp-server authentication username admin password admin SMTP Email Alert set authentication Username: admin, Password: admin Note: You can assign string to username and password.
Disable SMTP	Switch(config)# no smtp-server enable email-alert SMTP Email Alert set disable ok.
Disable Authentication	Switch(config)# no smtp-server authentication SMTP Email Alert set Authentication disable ok.
Display	Switch# sh smtp-server SMTP Email Alert is Enabled Server: 192.168.10.100, Account: admin@example.com Authentication: Enabled Username: admin, Password: admin SMTP Email Alert Receipt: Receipt 1: admin@example.com Receipt 2: Receipt 3: Receipt 4:

4.13 Monitor and Diagnostic

JetNet 6828Gf provides several types of features for you to monitor the status of the switch or diagnostic for you to check the problem when encountering problems related to the switch. The features include MAC Address Table, Port Statistics, Port Mirror, Event Log and Ping.

Following commands are included in this group:

4.13.1 MAC Address Table

4.13.2 Port Statistics

4.13.3 Port Mirroring

4.13.4 Event Log

4.13.5 Topology Discovery (LLDP)

4.13.6 Ping

4.13.7 Modbus/TCP

4.13.8 EtherNet/IP

4.13.9 CLI Commands of the Monitor and Diag

4.13.1 MAC Address Table

JetNet 6828Gf provides 16K entries in MAC Address Table. In this page, users can change the Aging time, add Static Unicast MAC Address, monitor the MAC address or sort them by different packet types and ports. Click on **Apply** to change the value.

Aging Time (Sec)

Each switch fabric has limit size to write the learnt MAC address. To save more entries for new MAC address, the switch fabric will age out non-used MAC address entry per Aging Time timeout. The default Aging Time is 300 seconds. The Aging Time can be modified in this page.

Static Unicast MAC Address

In some applications, users may need to type in the static Unicast MAC address to its MAC address table. In this page, you can type MAC Address (format: xxxx.xxxx.xxxx), select its VID and Port ID, and then click on **Add** to add it to MAC Address table.

MAC Address Table

In this MAC Address Table, you can see all the MAC Addresses learnt by the switch fabric. The packet types include Management Unicast, Static Unicast, Dynamic Unicast, Static Multicast and Dynamic Multicast. The table allows users to sort the address by the packet types and port.

Packet Types: Management Unicast means MAC address of the switch. It belongs to CPU port only. **Static Unicast** MAC address can be added and deleted. **Dynamic Unicast** MAC is MAC address learnt by the switch Fabric. **Static Multicast** can be added by CLI and can be deleted by Web and CLI. **Dynamic Multicast** will appear after you enabled IGMP and the switch learnt IGMP report.

Click on **Remove** to remove the static Unicast/Multicast MAC address. Click on **Reload** to refresh the table. New learnt Unicast/Multicast MAC address will be updated to MAC address table.

MAC Address Table

Aging Time (Sec)

Apply

Static Unicast MAC Address

MAC Address	VID	Port
<input type="text"/>	<input type="text"/>	Port 1 ▾

Add

MAC Address Table ▾

MAC Address	Address Type	VID	1	2	3	4	5	6	7	8	9	10
000f.b079.ca3b	Dynamic Unicast	1	<input type="checkbox"/>	<input type="checkbox"/>	<input type="checkbox"/>	<input checked="" type="checkbox"/>	<input type="checkbox"/>	<input type="checkbox"/>	<input type="checkbox"/>	<input type="checkbox"/>	<input type="checkbox"/>	<input type="checkbox"/>
0012.7701.0386	Dynamic Unicast	1	<input type="checkbox"/>	<input type="checkbox"/>	<input type="checkbox"/>	<input type="checkbox"/>	<input type="checkbox"/>	<input type="checkbox"/>	<input checked="" type="checkbox"/>	<input type="checkbox"/>	<input type="checkbox"/>	<input type="checkbox"/>
0012.7710.0101	Static Unicast	1	<input type="checkbox"/>	<input type="checkbox"/>	<input type="checkbox"/>	<input type="checkbox"/>	<input type="checkbox"/>	<input type="checkbox"/>	<input checked="" type="checkbox"/>	<input type="checkbox"/>	<input type="checkbox"/>	<input type="checkbox"/>
0012.7710.0102	Static Unicast	1	<input type="checkbox"/>	<input type="checkbox"/>	<input type="checkbox"/>	<input type="checkbox"/>	<input type="checkbox"/>	<input type="checkbox"/>	<input checked="" type="checkbox"/>	<input type="checkbox"/>	<input type="checkbox"/>	<input type="checkbox"/>
0012.77ff.0100	Management Unicast	1	<input type="checkbox"/>	<input type="checkbox"/>	<input type="checkbox"/>	<input type="checkbox"/>	<input type="checkbox"/>	<input type="checkbox"/>	<input type="checkbox"/>	<input type="checkbox"/>	<input type="checkbox"/>	<input type="checkbox"/>
0100.5e40.0800	fa6 Multicast	1	<input type="checkbox"/>	<input type="checkbox"/>	<input type="checkbox"/>	<input type="checkbox"/>	<input type="checkbox"/>	<input type="checkbox"/>	<input type="checkbox"/>	<input type="checkbox"/>	<input type="checkbox"/>	<input type="checkbox"/>
0100.5e7f.ffff	fa4,fa6 Multicast	1	<input type="checkbox"/>	<input type="checkbox"/>	<input type="checkbox"/>	<input type="checkbox"/>	<input type="checkbox"/>	<input type="checkbox"/>	<input type="checkbox"/>	<input type="checkbox"/>	<input type="checkbox"/>	<input type="checkbox"/>

Remove

Reload

4.13.2 Port Statistics

In this page, you can view operation statistics for each port. The statistics that can be viewed include Link Type, Link State, Rx Good, Rx Bad, Rx Abort, Tx Good, Tx Bad and Collision. Rx means the received packet while Tx means the transmitted packets.

Note: If you see many Bad, Abort or Collision counts increased, that may mean your network cable is not connected well, the network performance of the port is poor...etc. Please check your network cable, Network Interface Card of the connected device, the network application, or reallocate the network traffic...etc.

Click on **Clear Selected** to reinitialize the counts of the selected ports, and **Clear All** to reinitialize the counts of all ports. Click on **Reload** to refresh the counts.

Port Statistics

Port	Type	Link	State	Rx Good	Rx Bad	Rx Abort	Tx Good	Tx Bad	Collision
1	1000BASE	Down	Enable	0	0	0	0	0	0
2	1000BASE	Down	Enable	0	0	0	0	0	0
3	1000BASE	Down	Enable	0	0	0	0	0	0
4	1000BASE	Down	Enable	0	0	0	0	0	0
5	1000BASE	Down	Enable	0	0	0	0	0	0
6	1000BASE	Down	Enable	0	0	0	0	0	0
7	1000BASE	Up	Enable	395	0	2	1139	0	0
8	1000BASE	Down	Enable	0	0	0	0	0	0
9	1000BASE	Down	Enable	0	0	0	0	0	0
10	1000BASE	Down	Enable	0	0	0	0	0	0

Clear Selected

Clear All

Reload

4.13.3 Port Mirroring

Port mirroring (also called port spanning) is a tool that allows you to mirror the traffic from one or more ports onto another port, without disrupting the flow of traffic on the original port. Any traffic that goes into or out of the Source Port(s) will be duplicated at the Destination Port. This traffic can then be analyzed at the Destination port using a monitoring device or application. A network administrator will typically utilize this tool for diagnostics, debugging, or fending off attacks.

Port Mirror Mode: Select Enable/Disable to enable/disable Port Mirror.

Source Port: This is also known as Monitor Port. These are the ports you want to monitor. The traffic of all source/monitor ports will be copied to destination/analysis ports. You can choose single port or any combination of ports, you can monitor them in Rx only, TX only or both RX and TX. Click on checkbox of the RX, Tx to select the source ports.

Destination Port: This is also known as Analysis Port. You can analyze the traffic of all the monitored ports at this port without affecting the flow of traffic on the port(s) being monitored. Only one of the destination ports can be selected. A network administrator would typically connect a LAN analyzer or Netxray device to this port.

Port Mirroring

Port Mirror Mode

Port Selection

Port	Source Port		Destination Port
	Rx	Tx	
1	<input checked="" type="checkbox"/>	<input checked="" type="checkbox"/>	<input type="radio"/>
2	<input type="checkbox"/>	<input type="checkbox"/>	<input checked="" type="radio"/>
3	<input type="checkbox"/>	<input type="checkbox"/>	<input type="radio"/>
4	<input type="checkbox"/>	<input type="checkbox"/>	<input type="radio"/>
5	<input type="checkbox"/>	<input type="checkbox"/>	<input type="radio"/>
6	<input type="checkbox"/>	<input type="checkbox"/>	<input type="radio"/>
7	<input type="checkbox"/>	<input type="checkbox"/>	<input type="radio"/>
8	<input type="checkbox"/>	<input type="checkbox"/>	<input type="radio"/>
9	<input type="checkbox"/>	<input type="checkbox"/>	<input type="radio"/>
10	<input type="checkbox"/>	<input type="checkbox"/>	<input type="radio"/>
11	<input type="checkbox"/>	<input type="checkbox"/>	<input type="radio"/>
12	<input type="checkbox"/>	<input type="checkbox"/>	<input type="radio"/>

Once you finish configuring the settings, click on **Apply** to apply the settings.

4.13.4 Event Log

In the 4.10.3, we have introduced System Log feature. When System Log Local mode is selected, *JetNet 6828Gf* will record occurred events in local log table. This page shows this log table. The entry includes the index, occurred data and time and content of the events.

Click on **Clear** to clear the entries. Click on **Reload** to refresh the table.

System Event Logs

Index	Date	Time	Event Log
1	Jan 1	02:50:53	Event: Link 4 Up.
2	Jan 1	02:50:51	Event: Link 5 Down.
3	Jan 1	02:50:50	Event: Link 5 Up.
4	Jan 1	02:50:47	Event: Link 4 Down.

4.13.5 Topology Discovery (LLDP)

The *JetNet 6828Gf* supports 802.1AB Link Layer Discovery Protocol, thus the *JetNet 6828Gf* can be discovered by the Network Management System which support LLDP

discovery. With LLDP supported, the NMS can easier maintain the topology map, display port ID, port description, system description, VLAN ID... Once the link failure, the topology change events can be updated to the NMS as well. The LLDP Port State can display the neighbor ID and IP learnt from the connected devices.

LLDP: Enable/Disable the LLDP topology discovery information.

LLDP Configuration: To configure the related timer of LLDP.

LLDP timer: The LLDPDP interval, the LLDP information is send per LLDP timer. The default value is 30 seconds.

LLDP hold time: The TTL (Time To Live) timer. The LLDP state will be expired once the LLDPDP is not received by the hold time. The default is 120 seconds.

LLDP Port State: Display the neighbor information learnt from the connected interface.

4.13.6 Ping Utility

This page provides **Ping Utility** for users to ping remote device and check whether the device is alive or not. Type **Target IP** address of the target device and click on **Start** to start the ping. After few seconds, you can see the result in the **Result** field.

Ping Utility

Ping

Target IP	192.168.10.33
<input type="button" value="Start"/>	

Result

```
PING 192.168.10.33 (192.168.10.33): 56 data bytes
64 bytes from 192.168.10.33: icmp_seq=0 ttl=128 time=0.0 ms
64 bytes from 192.168.10.33: icmp_seq=1 ttl=128 time=0.0 ms
64 bytes from 192.168.10.33: icmp_seq=2 ttl=128 time=0.0 ms
64 bytes from 192.168.10.33: icmp_seq=3 ttl=128 time=0.0 ms
64 bytes from 192.168.10.33: icmp_seq=4 ttl=128 time=0.0 ms

--- 192.168.10.33 ping statistics ---
5 packets transmitted, 5 packets received, 0% packet loss
round-trip min/avg/max = 0.0/0.0/0.0 ms
```

4.13.7 Modbus/TCP

The Modbus is the most popular industrial protocol being used today. Modbus is a “master-slave” architecture, where the “master” sends polling request with address and data it wants to one of multiple “slaves”. The slave device that is addressed responds to master. The master is often a PC, PLC, DCS or RTU... The slaves are often the field devices. Some of them are “hybrid”.

There are three most common Modbus versions, Modbus ASCII, Modbus RTU and Modbus/TCP. Ethernet based device, Industrial Ethernet Switch for example, supports Modbus/TCP that it can be polled through Ethernet. Thus the Modbus/TCP master can read or write the Modbus registers provided by the Industrial Ethernet Switch.

Korenix *JetNet 6828Gf* implements the Modbus/TCP registers into the latest firmware. The registers include the System information, firmware information, IP address, interfaces’ status, port information, SFP information, inbound/outbound packet information.

With the supported registers, users can read the information through their own Modbus/TCP based progress/ display/ monitor applications and monitor the status of the switch easily.

There is no Web UI for Modbus/TCP configuration. The Modbus/TCP configuration can be changed through CLI.

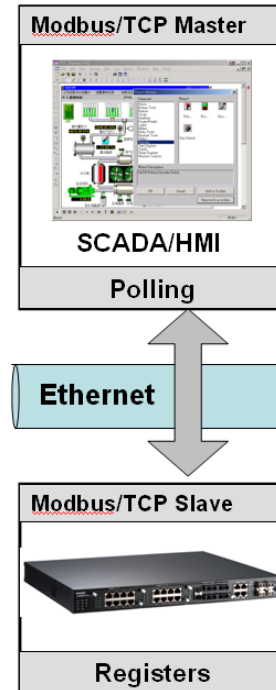

Modbus/TCP Register Table

Word Address	Data Type	Description
System Information		
0x0000	16 words	Vender Name = “Korenix” Word 0 Hi byte = ‘K’ Word 0 Lo byte = ‘o’ Word 1 Hi byte = ‘r’ Word 1 Lo byte = ‘e’ Word 2 Hi byte = ‘n’ Word 2 Lo byte = ‘l’ Word 2 Hi byte = ‘x’ Word 2 Lo byte = ‘\0’ (other words = 0)
0x0010	16 words	Product Name = "JetNet6828Gf-AC" Word 0 Hi byte = ‘J’ Word 0 Lo byte = ‘e’ Word 1 Hi byte = ‘T’

		Word 1 Lo byte = 'N' Word 2 Hi byte = 'e' Word 2 Lo byte = 't' Word 3 Hi byte = '5' Word 3 Lo byte = '4' Word 4 Lo byte = '2' Word 4 Hi byte = '8' Word 5 Lo byte = 'G' Word 5 Hi byte = 'V' Word 6 Lo byte = '2' Word 6 Lo byte = '-' Word 7 Hi byte = 'A' Word 7 Lo byte = 'C' Word 8 Hi byte = '0' (other words = 0)
0x0020	128 words	SNMP system name (string)
0x00A0	128 words	SNMP system location (string)
0x0120	128 words	SNMP system contact (string)
0x01A0	32 words	SNMP system OID (string)
0x01C0	2 words	System uptime (unsigned long)
0x01C2 to 0x01FF	60 words	Reserved address space
0x0200	2 words	hardware version
0x0202	2 words	S/N information
0x0204	2 words	CPLD version
0x0206	2 words	Boot loader version
0x0208	2 words	Firmware Version Word 0 Hi byte = major Word 0 Lo byte = minor Word 1 Hi byte = reserved Word 1 Lo byte = reserved
0x020A	2 words	Firmware Release Date Firmware was released on 2010-08-11 at 09 o'clock Word 0 = 0x0B09 Word 1 = 0x0A08
0x020C	3 words	Ethernet MAC Address Ex: MAC = 01-02-03-04-05-06

		Word 0 Hi byte = 0x01 Word 0 Lo byte = 0x02 Word 1 Hi byte = 0x03 Word 1 Lo byte = 0x04 Word 2 Hi byte = 0x05 Word 2 Lo byte = 0x06
0x020F to 0x2FF	241 words	Reserved address space
0x0300	2 words	IP address Ex: IP = 192.168.10.1 Word 0 Hi byte = 0xC0 Word 0 Lo byte = 0xA8 Word 1 Hi byte = 0x0A Word 1 Lo byte = 0x01
0x0302	2 words	Subnet Mask
0x0304	2 words	Default Gateway
0x0306	2 words	DNS Server
0x0308 to 0x3FF	248 words	Reserved address space (IPv6 or others)
0x0400	1 word	AC1 0x0000:Off 0x0001:On 0xFFFF: unavailable
0x0401	1 word	AC2 0x0000:Off 0x0001:On 0xFFFF: unavailable
0x0402	1 word	DC1 0x0000:Off 0x0001:On 0xFFFF: unavailable
0x0403	1 word	DC2 0x0000:Off 0x0001:On 0xFFFF: unavailable
0x0404 to 0x040F	12 words	Reserved address space
0x0410	1 word	D11

		0x0000:Off 0x0001:On 0xFFFF: unavailable
0x0411	1 word	DI2 0x0000:Off 0x0001:On 0xFFFF: unavailable
0x0412	1 word	DO1 0x0000:Off 0x0001:On 0xFFFF: unavailable
0x0413	1 word	DO2 0x0000:Off 0x0001:On 0xFFFF: unavailable
0x0414 to 0x041F	12 words	Reserved address space
0x0420	1 word	RDY 0x0000:Off 0x0001:On
0x0421	1 word	RM 0x0000:Off 0x0001:On
0x0422	1 word	RF 0x0000:Off 0x0001:On
0x0423	1 word	RS
Port Information (32 Ports)		
0x1000 to 0x11FF	16 words	Port Description
0x1200 to 0x121F	1 word	Administrative Status 0x0000: disable 0x0001: enable
0x1220 to 0x123F	1 word	Operating Status 0x0000: disable 0x0001: enable 0xFFFF: unavailable

0x1240 to 0x125F	1 word	Duplex 0x0000: half 0x0001: full 0x0003: auto (half) 0x0004: auto (full) 0x0005: auto 0xFFFF: unavailable
0x1260 to 0x127F	1 word	Speed 0x0001: 10 0x0002: 100 0x0003: 1000 0x0004: 2500 0x0005: 10000 0x0101: auto 10 0x0102: auto 100 0x0103: auto 1000 0x0104: auto 2500 0x0105: auto 10000 0x0100: auto 0xFFFF: unavailable
0x1280 to 0x129F	1 word	Flow Control 0x0000: off 0x0001: on 0xFFFF: unavailable
0x12A0 to 0x12BF	1 word	Default Port VLAN ID 0x0001-0xFFFF
0x12C0 to 0x12DF	1 word	Ingress Filtering 0x0000: disable 0x0001: enable
0x12E0 to 0x12FF	1 word	Acceptable Frame Type 0x0000: all 0x0001: tagged frame only
0x1300 to 0x131F	1 word	Port Security 0x0000: disable 0x0001: enable
0x1320 to 0x133F	1 word	Auto Negotiation 0x0000: disable 0x0001: enable

		0xFFFF: unavailable
0x1340 to 0x135F	1 word	Loopback Mode 0x0000: none 0x0001: MAC 0x0002: PHY 0xFFFF: unavailable
0x1360 to 0x137F	1 word	STP Status 0x0000: disabled 0x0001: blocking 0x0002: listening 0x0003: learning 0x0004: forwarding
0x1380 to 0x139F	1 word	Default CoS Value for untagged packets
0x13A0 to 0x13BF	1 word	MDIX 0x0000: disable 0x0001: enable 0x0002: auto 0xFFFF: unavailable
0x13C0 to 0x13DF	1 word	Medium mode 0x0000: copper 0x0001: fiber 0x0002: none 0xFFFF: unavailable
0x13E0 to 0x14FF	288 words	Reserved address space
SFP Information (32 Ports)		
0x1500 to 0x151F	1 word	SFP Type
0x1520 to 0x153F	1 words	Wave length
0x1540 to 0x157F	2 words	Distance
0x1580 to 0x167F	8 words	Vender
0x1680 to 0x17FF	384 words	Reserved address space
SFP DDM Information (32 Ports)		

0x1800 to 0x181F	1 words	Temperature
0x1820 to 0x185F	2 words	Alarm Temperature
0x1860 to 0x187F	1 words	Tx power
0x1880 to 0x18BF	2 words	Warning Tx power
0x18C0 to 0x18DF	1 words	Rx power
0x18E0 to 0x191F	2 words	Warning Rx power
0x1920 to 0x1FFF	1760 words	Reserved address space
Inbound packet information		
0x2000 to 0x203F	2 words	Good Octets
0x2040 to 0x207F	2 words	Bad Octets
0x2080 to 0x20BF	2 words	Unicast
0x20C0 to 0x20FF	2 words	Broadcast
0x2100 to 0x213F	2 words	Multicast
0x2140 to 0x217F	2 words	Pause
0x2180 to 0x21BF	2 words	Undersize
0x21C0 to 0x21FF	2 words	Fragments
0x2200 to 0x223F	2 words	Oversize
0x2240 to 0x227F	2 words	Jabbers
0x2280 to 0x22BF	2 words	Discards
0x22C0 to	2 words	Filtered frames

0x22FF		
0x2300 to 0x233F	2 words	RxError
0x2340 to 0x237F	2 words	FCSError
0x2380 to 0x23BF	2 words	Collisions
0x23C0 to 0x23FF	2 words	Dropped Frames
0x2400 to 0x243F	2 words	Last Activated SysUpTime
0x2440 to 0x24FF	191 words	Reserved address space
Outbound packet information		
0x2500 to 0x253F	2 words	Good Octets
0x2540 to 0x257F	2 words	Unicast
0x2580 to 0x25BF	2 words	Broadcast
0x25C0 to 0x25FF	2 words	Multicast
0x2600 to 0x263F	2 words	Pause
0x2640 to 0x267F	2 words	Deferred
0x2680 to 0x26BF	2 words	Collisions
0x26C0 to 0x26FF	2 words	SingleCollision
0x2700 to 0x273F	2 words	MultipleCollision
0x2740 to 0x277F	2 words	ExcessiveCollision
0x2780 to 0x27BF	2 words	LateCollision
0x27C0 to 0x27FF	2 words	Filtered

0x2800 to 0x283F	2 words	FCSError
0x2840 to 0x29FF	447 words	Reserved address space
Number of frames received and transmitted with a length(in octets)		
0x2A00 to 0x2A3F	2 words	64
0x2A40 to 0x2A7F	2 words	65 to 127
0x2A80 to 0x2ABF	2 words	128 to 255
0x2AC0 to 0x2AFF	2 words	256 to 511
0x2B00 to 0x2B3F	2 words	512 to 1023
0x2B40 to 0x2B7F	2 words	1024 to maximum size

4.13.8 EtherNet/IP

EtherNet/IP is one of an industrial protocol that provides some device information and accessed by Ethernet. *JetNet 6828Gf* provides both standard class and private class such as KorenixRing information.

Note: Data format for the EIP Encapsulation Protocol is Little-Endian.

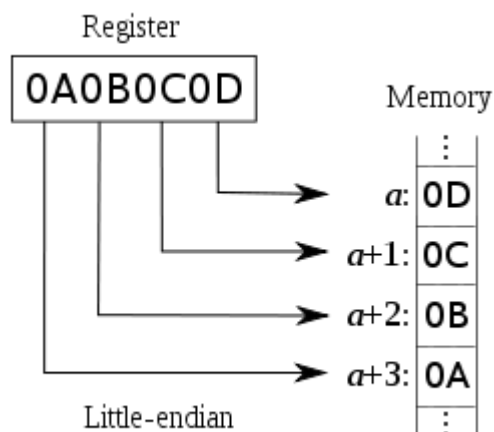

Example 1:

Identity Class (0x01) Attribute 3 Product Code (2 bytes)

Register Value: 0x0401 (JetNet6059G)

Low Byte = 0x01

High Byte = 0x04

Example 2:

Korenix Class (0x99) Attribute 5 Duplex (2 bytes)

Register Value: 0x0004 (Auto Full Duplex)

Low Byte = 0x04

HighByte = 0x006828

Following table lists the EtherNet/IP class supported by *JetNet 6828Gf*.

Identity Class(0x01)			
Attribute	Name	Format	Description
1	Vendor ID	2 bytes	Korenix Vendor ID : 1023 (0x03ff)
2	Device Type	2 bytes	0x0 (Generic Device)
3	Product Code	2 bytes	0x0000 UNKNOWN DEVICE 0x0101 JetNet4508 0x0102 JetNet4508f 0x0201 JetNet5010G 0x0202 JetNet5008G-P 0x0203 JetNet4510 0x0204 JetNet4506-RJ 0x0205 JetNet4506-M12 0x0206 JetNet5628G 0x0207 JetNet5018G 0x0208 JetNet5428G 0x0209 JetNet4510F 0x020A JetNet4006 0x020B JetNet4006F 0x020C JetNet5012G 0x020D JetNet5010GF 0x020E JetCard5010G-P 0x020F JetNet5428G-2G-2FX 0x0210 JetNet4518 0x0211 JetNet4508V2 0x0212 JetNet4508fV2 0x0213 JetNet5628G-R 0x0214 JetCard5308-P

			0x0301 JetNet4706 0x0302 JetNet4706f 0x0303 JetNet6710G 0x0304 JetNet5728G-24P 0x0305 JetNet5728G-16P 0x0306 JetNet5728G-8P 0x0307 JetNet5710G 0x0308 JetNet6810G 0x0309 JetNet5310G 0x030A JetNet6710G-HVDC 0x0401 JetNet6059G 0x0402 JetNet6528Gf 0x0402 JetNet6828Gf 0x0501 JetNet5828G 0x0602 JetNet6524G
4	Major Revision	1 bytes	
	Minor Revision	1 bytes	
5	Status	2 bytes	
6	Serial Number	4 bytes	
7	Product Name	String	Ex. JetNet5012G

TCP/IP Class(0xF5)			
Attribute	Name	Format	Description
1	Status	4 bytes	
2	Configuration Capability	4 bytes	
3	Configuration Control	4 bytes	
4	Physical Link		
	Path Size	2 bytes	
	Path	4 bytes	
5	Interface Configuration		
	IP Address	4 bytes	Ex.192.168.10.20 B[0] 0x14 B[1] 0x0A B[2] 0xA8 B[3] 0xC0

	Network Mask	4 bytes	
	Gateway Address	4 bytes	
	Name Server	4 bytes	
	Name Server 2	4 bytes	
	Domain Name	String	
6	Hostname	String	

Ethernet Link Class(0xF6)			
Attribute	Name	Format	Description
1	Interface Speed	2 bytes	
2	Interface Flags	2 bytes	
3	Physical Address	2 bytes	
4	Interface Counters		
	In Octets	4 bytes	
	In Ucast Packets	4 bytes	
	In Nucast Packets	4 bytes	
	In Discards	4 bytes	
	In Errors	4 bytes	
	In Unknown Protos	4 bytes	
	Out Octets	4 bytes	
	OutUcast Packets	4 bytes	
	Out Nucast Packets	4 bytes	
	Out Discards	4 bytes	
6	Interface Control		
	Control Bits	2 bytes	
	Forces Interface Speed	2 bytes	

Korenix Class(0x99)		
System Information (attribute 1)		
Name	Format	Description
Vendor Name	String	
Product Name	String	
Hardware Version	String	
S/N Information	String	
CPLD Version	String	

Boot loader Version	String	
Firmware Version	String	
Firmware Release Date	String	
Ethernet MAC	6 bytes	Ex. 00:12:77:FF:02:D9 B[0] 0x00 B[1] 0x12 B[2] 0x77 B[3] 0xFF B[4] 0x02 B[5] 0xD9
System Uptime	8 bytes	B[0]-B[3]: usec B[4]-B[7]: sec
SNMP Information (attribute 2)		
SNMP System Name	String	
SNMP System Location	String	
SNMP System Contact	String	
SNMP System OID	String	
Network Information (attribute 3)		
IP Address	4 bytes	Ex.192.168.10.20 B[0] 0x14 B[1] 0x0A B[2] 0xA8 B[3] 0xC0
Subnet Mask	4 bytes	
Default Gateway	4 bytes	
DNS Server 1	4 bytes	
DNS Server 2	4 bytes	
Hardware Information (attribute 4)		
AC1	2 bytes	AC1 0x0000 Off 0x0001 On 0xFFFF: unavailable
AC2	2 bytes	AC2 0x0000:Off 0x0001:On 0xFFFF: unavailable
DC1	2 bytes	DC1 0x0000:Off

		0x0001:On 0xFFFF: unavailable
DC2	2 bytes	DC2 0x0000:Off 0x0001:On 0xFFFF: unavailable
DI1	2 bytes	DI1 0x0000:Off 0x0001:On 0xFFFF: unavailable
DI2	2 bytes	DI2 0x0000:Off 0x0001:On 0xFFFF: unavailable
DO1	2 bytes	DO1 0x0000:Off 0x0001:On 0xFFFF: unavailable
DO2	2 bytes	DO2 0x0000:Off 0x0001:On 0xFFFF: unavailable
Ready	2 bytes	RDY 0x0000:Off 0x0001:On
RM / RS	2 bytes	RM / RS (Green light) 0x0000:Off 0x0001:On
RF / RS	2 bytes	RF / RS – (Yellow light) 0x0000:Off 0x0001:On
Port Information (attribute 5)		
Port	String	Port Name (ex. gigabitethernet1)
Administrative Status	2 bytes	Administrative Status 0x0000: disable 0x0001: enable
Operating Status	2 bytes	Operating Status

		0x0000: disable 0x0001: enable 0xFFFF: unavailable
Duplex	2 bytes	Duplex 0x0000: half 0x0001: full 0x0003: auto (half) 0x0004: auto (full) 0x0005: auto 0xFFFF: unavailable
Speed	2 bytes	Speed 0x0001: 10 Mbps 0x0002: 100 Mbps 0x0003: 1000 Mbps 0x0004: 2500 Mbps 0x0005: 10000 Mbps 0x0101: auto 10 Mbps 0x0102: auto 100 Mbps 0x0103: auto 1000 Mbps 0x0104: auto 2500 Mbps 0x0105: auto 10000 Mbps 0x0100: auto 0xFFFF: unavailable
Flow Control	2 bytes	Flow Control 0x0000: off 0x0001: on 0xFFFF: unavailable
PVID	2 bytes	Default Port VLAN ID 0x0001 : PVID = 1 0x0002 : PVID = 2
Ingress Filtering	2 bytes	Ingress Filtering 0x0000: disable 0x0001: enable
Acceptable Frame Type	2 bytes	Acceptable Frame Type 0x0000: all 0x0001: tagged frame only 0xFFFF: unavailable
Port Security	2 bytes	Port Security

		0x0000: disable 0x0001: enable 0xFFFF: unavailable
Auto Negotiation	2 bytes	Auto Negotiation 0x0000: disable 0x0001: enable 0xFFFF: unavailable
Loopback Mode	2 bytes	Loopback Mode 0x0000: none 0x0001: MAC 0x0002: PHY 0xFFFF: unavailable
STP States	2 bytes	STP Status 0x0000: disabled 0x0001: blocking 0x0002: listening 0x0003: learning 0x0004: forwarding
CoS	2 bytes	Default CoS Value for untagged packets
MDIX	2 bytes	MDIX 0x0000: disable 0x0001: enable 0x0002: auto 0xFFFF: unavailable
Medium Mode	2 bytes	Medium mode 0x0000: copper 0x0001: fiber 0x0002: none 0xFFFF: unavailable
Medium Type	2 bytes	Medium type 0x0000: none 0x0001: 100baseTX 0x0002: 1000baseT 0x0003: 100BaseFX 0x0004: 1000BaseSX 0x0005: 1000BaseLX 0x0006: other fiber transceiver 0x0007: fiber transceiver is not present

		0xFFFF: unavailable
SFP Information (attribute 6)		
SFP Type	2 bytes	SFP Type
Wave length	2 bytes	Wave length
Distance	4 bytes	Distance
Vender	16 bytes	Vender
SFP DDM Information (attribute7)		
Temperature	2 bytes	Temperature (Raw data)
Alarm Temperature	4 bytes	Alarm Temperature B[2]-B[3] : Raw data of High Alarm B[0]-B[1] : Raw data of Low Alarm
TX Power	2 bytes	Tx power (Raw data)
RX Power	2 bytes	Rx power (Raw data)
Warning TX Power	4 bytes	Warning Tx power B[2]-B[3] : Raw data of High Alarm B[0]-B[1] : Raw data of Low Alarm
Warning RX Power	4 bytes	Warning Rx power B[2]-B[3] : Raw data of High Alarm B[0]-B[1] : Raw data of Low Alarm

Korenix Ring Class(0x9a)		
Network Redundancy Information (attribute 1)		
Name	Format	Description
Ring Name	String	Ring Name
Status	2 bytes	Ring Status 0x0000: Normal 0x0001: Abnormal 0x0002: Occupied 0x0003: Unknown
Version	2 bytes	Ring Version 0x0000: none 0x0001: Super Ring 0x0002: Rapid Super Ring 0x0003: Any Ring

		0x0004: not support 0xFFFF: unavailable
Role	2 bytes	Ring Device Role 0x0000: none 0x0001: disable 0x0002: RM (Ring Master) 0x0003: non-RM 0xFFFF: unavailable
Ring Port 1	4 bytes	Ring Port List of 1st Ring Port B[0]-B[1] : port 1-16 B[2]-B[3] : port 17-32 Ex: 0x00000001: Ethernet port 1 B[0] 0x01 B[1] 0x00 B[3] 0x00 B[4] 0x00
Ring Port 2	4 bytes	Ring Port List of 2nd Ring Port B[0]-B[1] : port 1-16 B[2]-B[3] : port 17-32 Ex: 0x00000002: Ethernet port 2 B[0] 0x02 B[1] 0x00 B[3] 0x00 B[4] 0x00
RM MAC	6 bytes	Ring Master MAC address Ex: MAC = 00-12-77-FF-05-06 B[0] 0x00 B[1] 0x12 B[2] 0x77 B[3] 0xFF B[4] 0x05 B[5] 0x06
Blocked Port List	4 bytes	Ring Blocked Port List B[0]-B[1] : port 1-16 B[2]-B[3] : port 17-32 Ex: 0x00000002: Ethernet port 2 B[0] 0x02

		B[1] 0x00 B[3] 0x00 B[4] 0x00
RDH Status	2 bytes	Ring Rapid Dual Homing Status 0x0000: None 0x0001: Disable 0x0002: Enable 0xFFFF: unavailable
SuperChain Status	2 bytes	SuperChain Status 0x0000: Disable 0x0001: Member 0x0002: Border 0x0003: Border Head 0xFFFF: unavailable

Note : The instance of Korenix Ring Class is the number of the Ring, not Ring ID.

Ex.

Ring 3

Ring 5

Instance 1 → the first ring, Ring 3

Instance 2 → the second ring, Ring 5

4.13.9 CLI Commands of the Monitor and Diag

Command Lines of the Monitor and Diag configuration

Feature	Command Line
MAC Address Table	
Ageing Time	Switch(config)# mac-address-table aging-time 350 mac-address-table aging-time set ok! <i>Note: 350 is the new ageing timeout value.</i>
Add Static Unicast MAC address	Switch(config)# mac-address-table static 0012.7701.0101 vlan 1 interface fastethernet7 mac-address-table ucast static set ok! Note: rule: mac-address-table static MAC_address VLAN VID interface interface_name
Add Multicast MAC address	Switch(config)# mac-address-table multicast 0100.5e01.0101 vlan 1 interface fa6-7 Adds an entry in the multicast table ok! Note: rule: mac-address-table multicast MAC_address VLAN VID interface_list interface_name/range
Show MAC Address Table – All types	Switch# show mac-address-table ***** UNICAST MAC ADDRESS *****

	<pre> Destination Address Address Type Vlan Destination Port ----- 000f.b079.ca3b Dynamic 1 gi4 0012.7701.0386 Dynamic 1 gi7 0012.7710.0101 Static 1 gi7 0012.7710.0102 Static 1 gi7 0012.77ff.0100 Management 1 ***** MULTICAST MAC ADDRESS ***** Vlan Mac Address COS Status Ports ----- 1 0100.5e40.0800 0 gi6 1 0100.5e7f.ffa 0 gi4,gi6 </pre>
Show MAC Address Table – Dynamic Learnt MAC addresses	<pre> Switch# show mac-address-table dynamic Destination Address Address Type Vlan Destination Port ----- 000f.b079.ca3b Dynamic 1 gi4 0012.7701.0386 Dynamic 1 gi7 </pre>
Show MAC Address Table – Multicast MAC addresses	<pre> Switch# show mac-address-table multicast Vlan Mac Address COS Status Ports ----- 1 0100.5e40.0800 0 gi6-7 1 0100.5e7f.ffa 0 gi4,gi6-7 </pre>
Show MAC Address Table – Static MAC addresses	<pre> Switch# show mac-address-table static Destination Address Address Type Vlan Destination Port ----- 0012.7710.0101 Static 1 gi7 0012.7710.0102 Static 1 gi7 </pre>
Show Aging timeout time	<pre> Switch# show mac-address-table aging-time the mac-address-table aging-time is 300 sec. </pre>
Port Statistics	
Port Statistics	<pre> Switch# show rmon statistics gi4 (select interface) Interface gigabitethernet4 is enable connected, which has Inbound: Good Octets: 178792, Bad Octets: 0 Unicast: 598, Broadcast: 1764, Multicast: 160 Pause: 0, Undersize: 0, Fragments: 0 Oversize: 0, Jabbers: 0, Disacrd: 0 Filtered: 0, RxError: 0, FCSError: 0 Outbound: Good Octets: 330500 Unicast: 602, Broadcast: 1, Multicast: 2261 Pause: 0, Deferred: 0, Collisions: 0 SingleCollision: 0, MultipleCollision: 0 ExcessiveCollision: 0, LateCollision: 0 Filtered: 0, FCSError: 0 Number of frames received and transmitted with a length of: 64: 2388, 65to127: 142, 128to255: 11 256to511: 64, 512to1023: 10, 1024toMaxSize: 42 </pre>
Port Mirroring	
Enable Port Mirror	<pre> Switch(config)# mirror en Mirror set enable ok. </pre>
Disable Port Mirror	<pre> Switch(config)# mirror disable Mirror set disable ok. </pre>
Select Source Port	<pre> Switch(config)# mirror source gi1-2 both Received and transmitted traffic rx Received traffic </pre>

	<pre>tx Transmitted traffic Switch(config)# mirror source gi1-2 both Mirror source gi1-2 both set ok.</pre> <p>Note: Select source port list and TX/RX/Both mode.</p>
Select Destination Port	<pre>Switch(config)# mirror destination gi6 both Mirror destination fa6 both set ok</pre>
Display	<pre>Switch# show mirror Mirror Status : Enabled Ingress Monitor Destination Port : gi6 Egress Monitor Destination Port : gi6 Ingress Source Ports :gi1 ,gi2, Egress Source Ports :gi1,gi2,</pre>
Event Log	
Display	<pre>Switch# show event-log <1>Jan 1 02:50:47 snmpd[101]: Event: Link 4 Down. <2>Jan 1 02:50:50 snmpd[101]: Event: Link 5 Up. <3>Jan 1 02:50:51 snmpd[101]: Event: Link 5 Down. <4>Jan 1 02:50:53 snmpd[101]: Event: Link 4 Up.</pre>
Topology Discovery (LLDP)	
Enable LLDP	<pre>Switch(config)# lldp holdtime Specify the holdtime of LLDP in seconds run Enable LLDP timer Set the transmission frequency of LLDP in seconds Switch(config)# lldp run LLDP is enabled!</pre>
Change LLDP timer	<pre>Switch(config)# lldp holdtime <10-255> Valid range is 10~255 Switch(config)# lldp timer <5-254> Valid range is 5~254</pre>
Ping	
Ping IP	<pre>Switch# ping 192.168.10.33 PING 192.168.10.33 (192.168.10.33): 56 data bytes 64 bytes from 192.168.10.33: icmp_seq=0 ttl=128 time=0.0 ms 64 bytes from 192.168.10.33: icmp_seq=1 ttl=128 time=0.0 ms 64 bytes from 192.168.10.33: icmp_seq=2 ttl=128 time=0.0 ms 64 bytes from 192.168.10.33: icmp_seq=3 ttl=128 time=0.0 ms 64 bytes from 192.168.10.33: icmp_seq=4 ttl=128 time=0.0 ms --- 192.168.10.33 ping statistics --- 5 packets transmitted, 5 packets received, 0% packet loss round-trip min/avg/max = 0.0/0.0/0.0 ms</pre>
Modbus/TCP	
Number of the Modbus/TCP Master	<pre>Switch(config)# modbus idle-timeout Max interval between requests master Modbus TCP Master port Listening Port Switch(config)# modbus master <1-20> Max Modbus TCP Master</pre>
Modbus/TCP idle time	<pre>Switch(config)# modbus idle-timeout <200-10000> Timeout vlaue: 200-10000ms</pre>
Modbus/TCP port number	<pre>Switch(config)# modbus port <1-65535> Port Number</pre>
EtherNet/IP	
EtherNet/IP enable	<pre>Switch(config)# ethernet-ip run Ethernet/IP is enabled!</pre>
EtherNet/IP disable	<pre>Switch(config)# no ethernet-ip run Ethernet/IP is disabled!</pre>

4.14 Device Front Panel

Device Front Panel command allows you to see LED status of the switch. You can see LED and link status of the Power, Alarm(DO), R.S. and Ports.

Feature	On / Link UP	Off / Link Down	Note
Power	Green	Black	
Alarm	Red	Black	
R.S. (Ring Status)	Green/Yellow	Black	Green: Ring in normal state Yellow: MSR in abnormal state
Port Link LED	Green	Black	
Port Active LED	Green	Black	
Port Link State	Green	Black	Green: The port is connected. Black: Not connected.
SFP Link State	Green	Black	Gray: Plugged but not link up yet.

JetNet 6828Gf-AC/6828Gf-2AC/6828Gf-AC-DC24/6828Gf-2DC24/6828Gf-2DC48 Front Panel

Device Front Panel

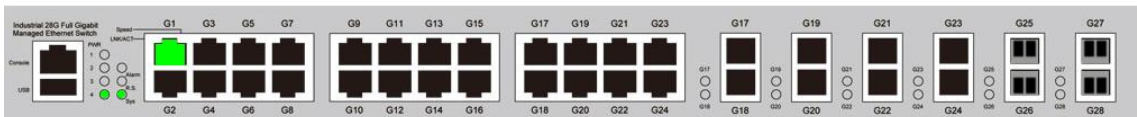

Note: When R.S. LED Blink on hardware, the Web front panel shows light with "Orange light" indication

Note: No CLI command for this feature.

4.15 Save to Flash

Save Configuration allows you to save any configuration you just made to the Flash. Powering off the switch without clicking on **Save Configuration** will cause loss of new settings. After selecting **Save Configuration**, click on **Save to Flash** to save your new configuration.

Save to Flash

Note: This command will permanently save the current configuration to flash.

Save to Flash

After saved the configuration successfully, the popup window appears to show Save configuration to flash ok.

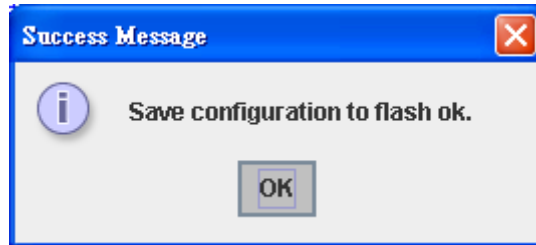

Command Lines:

Feature	Command Line
Save	SWITCH# write Building Configuration... [OK] Switch# copy running-config startup-config Building Configuration... [OK]

4.16 Logout

The switch provides 2 logout methods. The web connection will be logged out if you don't input any command after 30 seconds. The Logout command allows you to manually logout the web connection. Click on **Yes** to logout, **No** to go back the configuration page.

Save to Flash

Note: This command will permanently save the current configuration to flash.



Command Lines:

Feature	Command Line
Logout	SWITCH> exit
	SWITCH# exit

5 Appendix

5.1 Korenix SFP family

Korenix certificated many types of SFP transceiver. These certificated SFP transceivers can be identified by *JetNet 6828Gf* and displayed in the UI. The SFP transceivers we certificated can meet up the industrial critical environment needs. We recommend you to use Korenix certificated SFP transceivers when you constructing your network.

Korenix will keep on certificating and updating the certificated SFP transceivers in Korenix web site and purchase list. You can refer to the web site to get the latest information about SFP transceivers.

Note: Poor SFP transceivers may result in poor network performance or can't meet up claimed distance or temperature.

Model Name	Spec
SFPGSX	1000Base-SX multi-mode SFP transceiver,550m, -10~70°C
SFPGSX-w	1000Base-SX multi-mode SFP transceiver,550m, wide operating temperature, -40~85°C
SFPGSX2	1000Base-SX plus multi-mode SFP transceiver,2Km, -10~70°C
SFPGSX2-w	1000Base-SX plus multi-mode SFP transceiver, 2Km,wide operating temperature, -10~70°C
SFPGXLX10	1000Base-LX single-mode SFP transceiver 10Km, -10~70°C
SFPGXLX10-w	1000Base-LX single-mode SFP transceiver, 10Km, wide operating temperature, -40~85°C
SFPGLHX30	1000Base-LHX single-mode SFP transceiver,30Km, -10~70°C
SFPGLHX30-w	1000Base-LHX single-mode SFP transceiver, 30Km, wide operating temperature, -40~85°C
SFPGXD50	1000Base-XD single-mode SFP transceiver, 50Km, -10~70°C
SFPGXD50-w	1000Base-XD single-mode SFP transceiver, 50Km, wide operating temperature, -40~85°C
SFP100MM	Multi-mode 100Mbps 2KM Fiber Transceiver, 0~70°C.
SFP100MM-w	Multi-mode 100Mbps 2KM Fiber Transceiver, wide operating temperature -40~85°C.

SFP100SM30 Single mode 100Mbps 30KM Fiber Transceiver 0~70°C .

SFP100SM30-w Single mode 100Mbps 30Km Fiber Transceiver, wide operating temperature. -40~85°C

5.2 Korenix Private MIB

Korenix provides many standard MIBs for users to configure or monitor the switch's configuration by SNMP. But, since some commands can't be found in standard MIB, Korenix provides Private MIB to meet up the need. Compile the private MIB file by your SNMP tool. You can then use it. Private MIB can be found in product CD or downloaded from Korenix Web site.

Private MIB tree is similar to the web tree. This is easier to understand and use. If you are not familiar with standard MIB, you can directly use private MIB to manage /monitor the switch, no need to learn or find where the OIDs of the commands are.

The path of the *JetNet 6828Gf* is **1.3.6.1.4.1.24062.2.4.2**.

Compile the private MIB file and you can see all the MIB tables in MIB browser.

5.3 Revision History

Edition	Date	Modifications
V1.0	Aug. 1, 2016	The first version.

5.4 About Korenix

Less Time At Work! Fewer Budget on applications!

The Korenix business idea is to let you spend less time at work and fewer budget on your applications. Do you really want to go through all the troubles but still end up with low quality products and lousy services? Definitely not! This is why you need Korenix. Korenix offers complete product selection that fulfills all your needs for applications. We provide easier, faster, tailor-made services, and more reliable solutions. In Korenix, there is no need to compromise. Korenix takes care of everything for you!

Fusion of Outstandings

You can end your searching here. Korenix Technology is your one-stop supply center for industrial communications and networking products. Korenix Technology is established by a group of professionals with more than 10 year experience in the arenas of industrial control, data communications and industrial networking applications. Korenix Technology is well-positioned to fulfill your needs and demands by providing a great variety of tailor-made products and services. Korenix's industrial-grade products also come with quality services. No more searching, and no more worries. Korenix Technology stands by you all the way through.

Core Strength---Competitive Price and Quality

With our work experience and in-depth know-how of industrial communications and networking, Korenix Technology is able to combine Asia's research / development ability with competitive production cost and with quality service and support.

Global Sales Strategy

Korenix's global sales strategy focuses on establishing and developing trustworthy relationships with value added distributors and channel partners, and assisting OEM distributors to promote their own brands. Korenix supplies products to match local market requirements of design, quality, sales, marketing and customer services, allowing Korenix and distributors to create and enjoy profits together.

Quality Services

KoreCARE--- KoreCARE is Korenix Technology's global service center, where our professional staffs are ready to solve your problems at any time and in real-time. All of Korenix's products have passed ISO-9000/EMI/CE/FCC/UL certifications, fully satisfying your demands for product quality under critical industrial environments. Korenix global service center's e-mail is koreCARE@korenix.com

5 Years Warranty

Each of Korenix's product line is designed, produced, and tested with high industrial standard. Korenix warrants that the Product(s) shall be free from defects in materials and workmanship for a period of five (5) years from the date of delivery provided that the Product was properly installed and used. This warranty is voided if defects, malfunctions or failures of the warranted Product are caused by damage resulting from force measure (such as floods, fire, etc.), environmental and atmospheric disturbances, other external forces such as power line disturbances, host computer malfunction, plugging the board in under power, or incorrect cabling; or the warranted Product is misused, abused, or operated, altered and repaired in an unauthorized or improper way

Korenix Technologies Co., Ltd.

Business service: sales@korenix.com

Customer service: koreCARE@korenix.com