

User's Manual

Fanless Computing Solution



Compact Size Fanless Computer
DC-1100

Contents

Prefaces

Revision	04
Copyright Notice	04
Acknowledgement	04
Disclaimer	04
Declaration of Conformity	05
Product Warranty Statement	05
Technical Support and Assistance	06
Conventions Used in this Manual	06
Safety Precaution	07
Package Contents	08
Ordering Information	08
Optional Accessory	09

Chapter 1 Product Introductions

1.1 Overview	11
1.1.1 Key Feature	11
1.2 Hardware Specification	12
1.3 System I/O	13
1.3.1 Front Panel	13
1.3.2 Rear Panel	13
1.4 Mechanical Dimension	14

Chapter 2 Jumpers and Connectors

2.1 Jumper Settings	16
2.2 Locations of the Jumper and Connector	16
2.2.1 Top View	16
2.2.2 Bottom View	17
2.2.3 Daughterboard view	17
2.3 List of Switch / Jumper / Connector	18
2.4 Switch Definition	19
2.5 Jumper Definition	19
2.6 Connector Definition	20

Chapter 3 System Setup

3.1 Removing the Chassis Bottom Cover	31
3.2 Removing the Chassis	32
3.3 Installing a Half Size Mini PCIe Card on Top Side	33
3.4 Installing a Full Size Mini PCIe Card on Top Side	35
3.5 Installing Antenna	36
3.6 Installing a Half Size Mini PCIe Card on Bottom Side	38
3.7 Installing a Full Size Mini PCIe Card on Bottom Side	40
3.8 Installing a SATA Hard Drive	41
3.9 Installing a SODIMM	42
3.10 Installing the Chassis	43
3.11 Installing the Chassis Bottom Cover	44
3.12 Installing a SIM Card	45
3.13 Installing a CF Card	46

3.14 Wall Mount Bracket 47
 3.15 Side Mount Bracket 48
 3.16 VESA Mount Bracket 49
 3.17 DIN-Rail Mount Bracket 50

Chapter 4 BIOS Setup

4.1 BIOS Introduction 52
 4.2 Main Setup 53
 4.2.1 System Date 53
 4.2.2 System Time 53
 4.3 Advanced Setup 54
 4.3.1 ACPI Settings 54
 4.3.2 Super IO Configuration 55
 4.3.3 Hardware Monitor 58
 4.3.4 Serial Port Console Redirection 58
 4.3.5 CPU Configuration 59
 4.3.6 PPM Configuration 60
 4.3.7 Thermal Configuration 61
 4.3.8 IDE Configuration 62
 4.3.9 Compatibility Support Module Configuration 63
 4.3.10 USB Configuration 64
 4.4 Chipset 65
 4.4.1 North Bridge 65
 4.4.2 South Bridge 67
 4.5 Security 69
 4.5.1 Administrators Password 69
 4.5.2 Users Password 69
 4.6 Boot 70
 4.6.1 Setup Prompt Timeout 70
 4.6.2 Bootup NumLock State 70
 4.6.3 Full Screen Logo Show 70
 4.6.4 Fast Boot 70
 4.7 Save & Exit 71
 4.7.1 Save Changes and Reset 71
 4.7.2 Discard Changes and Reset 71
 4.7.3 Restore Defaults 71
 4.7.4 Save as User Defaults 71
 4.7.5 Restore User Defaults 71

Prefaces

Revision

Revision	Description	Date
1.0	Manual Released	2014/09/29
1.1	New Optional Accessories Released	2015/01/13

Copyright Notice

© 2014 by Cincoze Co., Ltd. All rights are reserved. No parts of this manual may be copied, modified, or reproduced in any form or by any means for commercial use without the prior written permission of Cincoze Co., Ltd. All information and specification provided in this manual are for reference only and remain subject to change without prior notice.

Acknowledgement

Cincoze is a registered trademark of Cincoze Co., Ltd. All registered trademarks and product names mentioned herein are used for identification purposes only and may be trademarks and/or registered trademarks of their respective owners.

Disclaimer

This manual is intended to be used as a practical and informative guide only and is subject to change without notice. It does not represent a commitment on the part of Cincoze. This product might include unintentional technical or typographical errors. Changes are periodically made to the information herein to correct such errors, and these changes are incorporated into new editions of the publication.

Declaration of Conformity



FCC

This equipment has been tested and found to comply with the limits for a Class A digital device, pursuant to Part 15 of the FCC Rules. These limits are designed to provide reasonable protection against harmful interference when the equipment is operated in a commercial environment. This equipment generates, uses, and can radiate radio frequency energy and, if not installed and used in accordance with the instruction manual, may cause harmful interference to radio communications. Operation of this equipment in a residential area is likely to cause harmful interference in which case the user will be required to correct the interference at his own expense.



CE

The product(s) described in this manual complies with all application European Union (CE) directives if it has a CE marking. For computer systems to remain CE compliant, only CE-compliant parts may be used. Maintaining CE compliance also requires proper cable and cabling techniques.

Product Warranty Statement

Warranty

Cincoze products are warranted by Cincoze Co., Ltd. to be free from defect in materials and workmanship for 2 years from the date of purchase by the original purchaser.

During the warranty period, we shall, at our option, either repair or replace any product that proves to be defective under normal operation.

Defects, malfunctions, or failures of the warranted product caused by damage resulting from natural disasters (such as by lightening, flood, earthquake, etc.), environmental and atmospheric disturbances, other external forces such as power line disturbances, plugging the board in under power, or incorrect cabling, and damage caused by misuse, abuse, and unauthorized alteration or repair, and the product in question is either software, or an expendable item (such as a fuse, battery, etc.), are not warranted.

RMA

Before sending your product in, you will need to fill in Cincoze RMA Request Form and obtain a RMA number from us. Our staff is available at any time to provide you with the most friendly and immediate service.

■ RMA Instruction

- Customers must fill in Cincoze Return Merchandise Authorization (RMA) Request Form and obtain a RMA number prior to returning a defective product to Cincoze for service.
- Customers must collect all the information about the problems encountered and note anything abnormal and describe the problems on the "Cincoze Service Form" for the RMA number apply process.
- Charges may be incurred for certain repairs. Cincoze will charge for repairs to products whose warranty period has expired. Cincoze will also charge for repairs to products if the damage resulted from acts of God, environmental or atmospheric disturbances, or other external forces through misuse, abuse, or unauthorized alteration or repair. If charges will be incurred for a repair, Cincoze lists all charges, and will wait for customer's approval before performing the repair.
- Customers agree to insure the product or assume the risk of loss or damage during transit, to prepay shipping charges, and to use the original shipping container or equivalent.
- Customers can be send back the faulty products with or without accessories (manuals, cable, etc.) and any components from the system. If the components were suspected as part of the problems, please note clearly which components are included. Otherwise, Cincoze is not responsible for the devices/parts.
- Repaired items will be shipped along with a "Repair Report" detailing the findings and actions taken.

Limitation of Liability

Cincoze' liability arising out of the manufacture, sale, or supplying of the product and its use, whether based on warranty, contract, negligence, product liability, or otherwise, shall not exceed the original selling price of the product. The remedies provided herein are the customer's sole and exclusive remedies. In no event shall Cincoze be liable for direct, indirect, special or consequential damages whether based on contract of any other legal theory.

Technical Support and Assistance

1. Visit the Cincoze website at www.cincoze.com/support.php where you can find the latest information about the product.
2. Contact your distributor or our technical support team or sales representative for technical support if you need additional assistance. Please have following information ready before you call:
 - Product name and serial number
 - Description of your peripheral attachments
 - Description of your software (operating system, version, application software, etc.)
 - A complete description of the problem
 - The exact wording of any error messages

Conventions Used in this Manual



WARNING

This indication alerts operators to an operation that, if not strictly observed, may result in severe injury.



CAUTION

This indication alerts operators to an operation that, if not strictly observed, may result in safety hazards to personnel or damage to equipment.



NOTE

This indication provides additional information to complete a task easily.

Safety Precautions

Before installing and using this device, please note the following precautions:

1. Read these safety instructions carefully.
2. Keep this User's Manual for future reference.
3. Disconnect this equipment from any AC outlet before cleaning.
4. For plug-in equipment, the power outlet socket must be located near the equipment and must be easily accessible.
5. Keep this equipment away from humidity.
6. Put this equipment on a reliable surface during installation. Dropping it or letting it fall may cause damage.
7. Make sure the voltage of the power source is correct before connecting the equipment to the power outlet.
8. Use a power cord that has been approved for using with the product and that it matches the voltage and current marked on the product's electrical range label. The voltage and current rating of the cord must be greater than the voltage and current rating marked on the product.
9. Position the power cord so that people cannot step on it. Do not place anything over the power cord.
10. All cautions and warnings on the equipment should be noted.
11. If the equipment is not used for a long time, disconnect it from the power source to avoid damage by transient overvoltage.
12. Never pour any liquid into an opening. This may cause fire or electrical shock.
13. Never open the equipment. For safety reasons, the equipment should be opened only by qualified service personnel.

If one of the following situations arises, get the equipment checked by service personnel:
 - The power cord or plug is damaged.
 - Liquid has penetrated into the equipment.
 - The equipment has been exposed to moisture.
 - The equipment does not work well, or you cannot get it to work according to the user's manual.
 - The equipment has been dropped and damaged.
 - The equipment has obvious signs of breakage.
14. CAUTION: Danger of explosion if battery is incorrectly replaced. Replace only with the same or equivalent type recommended by the manufacturer.

Package Contents

Before installation, please ensure all the items listed in the following table are included in the package.

Item	Description	Q'ty
1	DC-1100 Embedded System	1
2	Utility DVD Driver	1
3	DIO Terminal Block Connector (Female)	1
4	Power Terminal Block Connector (Female)	1
5	DVI-I to VGA Adapter	1
6	Screw Pack	1
7	Wall Mount Kit	1

Note: Notify your sales representative if any of the above items are missing or damaged.

Ordering Information

Model No.	Product Description
DC-1100	Intel® Atom™ E3845 Quad Core™ Compact Size Fanless Computer and 2x Mini-PCIe Expansion

Optional Accessories

Model Name	Description
GSM60A12-CIN	Adapter AC/DC 12V 5A 60W with 3pin Terminal Block Plug 5.0mm Pitch, GSM60A12-P1J
SL2-SL3	US 2 heads power cord, US B type to IEC C13, SVT 18AWG/3C Black 1.8M SL-2+SL-3
SL6-SL3	EU 2 heads power cord, EU G type to IEC C13, H05VV-F 0.75mm ² /3G Black 1.8M SL-6+SL-3
QP026-SL3	UK 2 heads power cord, UK I type to IEC C13, H05VV-F 0.75mm ² /3G Black 1.8M QP026+SL-3
VESA-DC	DC series VESA Mount Kit
SIDE-DC	DC series SIDE Mount Kit
DINRAIL	Diamond series DIN-RAIL Mount Kit
59381560000E	MINI-DIN(M) (PS/2 KB+MS) TO MINI-DIN(F) (PS/2 KB)+MINI-DIN(F) (PS/2 MS) L:10CM, 59381560000E
N0307-140507-01	DVI-I(M) TO DVI-D(F) + VGA(F) Cable, L=200mm, N0307-140507-01



Chapter 1

Product Introductions

1.1 Overview

DC-1100 is a high performance compact size (185mm (W) x 131mm (D) x 54mm (H)) system designed with onboard Intel® Atom™ E3845 Quad Core 1.91GHz processor, rich I/O, unique expansion capability, and wide range (9~48V) DC power input. It supports the latest USB 3.0 technology.

With features including completely cable-less designed, special heat dissipation, anti-vibration, and industrial components selection, DC-1100 is a ruggedized system that can operate in harsh environments.

A build in voltage protection, reliable DC power input, and reverse power protection make DC-1100 a safety system for industrial applications.



Front



Rear

1.1.1 Key Features

- Onboard Intel® Atom™ E3845 processor Quad Core, 1.91GHz
- 1x DDR3L SO-DIMM max. up to 4GB
- Dual Independent Display from 1x DVI-I and 1x DisplayPort
- 2x Intel® GbE port, support Wake-on-LAN and PXE
- 1x USB 3.0, 3x USB2.0
- 4x RS232/422/485 port with 5V/12V power
- 4x Isolated DI, 4x Isolated DO
- 1x 2.5" SATA SSD/HDD bay, 1x CFast card and 1x SIM card socket
- 9~48VDC power input, support AT/ATX mode
- 2x Mini-PCIe slot for Wi-Fi, GSM, or I/O expansion
- Universal I/O bracket for Mini-PCIe expansion

1.2 Hardware Specification

Processor System

- Onboard Intel® Atom™ Processor E3845 Quad Core, 1.91 GHz with AMI 64Mbit SPI BIOS.

Memory

- 1x 204-Pin DDR3L-1066/ 1333MHz SO-DIMM (un-buffered and non-ECC), max. up to 4GB

Display

Dual Display

- 1x DVI and 1x DisplayPort
- 1x DVI-D and 1x VGA (w/ Optional Split Cable)
- 1x DisplayPort and 1x VGA (w/ DVI-I to VGA Adapter)

Expansion

- 2x Full-size Mini PCIe Socket for Wi-Fi / GSM / Expansion Module
- 1x Universal I/O Bracket

Ethernet

- 2 x Intel® I210-AT GbE LAN Port, Support Wake-on-LAN and PXE

Audio

- Codec: Realtek ALC888S
- 1x Mic-in and 1x Speak-out

Watchdog Timer

- Software Programmable Supports 1~255 sec. System Reset

Storage

- 1x 2.5" SATA SSD/HDD Bay
- 1x External CFast Socket
- 1x External SIM Card Socket

I/O Ports

- 1x USB 3.0 Port
- 3x USB 2.0 Port
- 4 x DB9 for COM1~4, Support RS232/422/485 with Auto Flow Control
- 2x Antenna Hole
- 1x Power Switch
- 1x AT/ATX Switch

Digital Input & Output

- 4x Digital Input (Source Type)
 - Input Voltage (Dry Contact):
 - Logic 0: Close to GND
 - Logic 1: Open
 - Input Voltage:
 - Logic 0: 3V max.
 - Logic 1: 5V min. (DI to COM-)
- 4x Digital Output
 - Supply Voltage: 5~30VDC
 - Sink Current: 200 mA Max. Per Channel

Power

- Support AT, ATX Mode
- 1x 3-pin Terminal Block Connector with Power Input 9~48VDC
- 1x Optional AC/DC 12V/5A, 60W Power Adapter

Environment

- Operating Temperature: Ambient with Air Flow: -20°C to 70°C (with Industrial Grade Peripherals)
- Storage Temperature: -30°C to 85°C
- Relative humidity: 10%~95% (non-condensing)

Physical

- Dimension (WxDxH, mm): 185 x 131 x 54 mm
- Weight: 1.58 kg
- Construction: Extruded Aluminum with Heavy Duty Metal
- Mounting: Wall, Optional Side/VESA/DIN-Rail Mounting

Operating System

- Windows® 8
- Windows® 7
- Windows® Embedded Standard 7

Certifications

- CE
- FCC Class A

1.3 System I/O

1.3.1 Front Panel

ATX power on/off switch

Press to power-on or power-off the system

Power LED

Indicates the power status of the system

HDD LED

Indicates the status of the hard drive

USB 2.0 port

Used to connect USB 2.0/1.1 device

AT/ATX mode select switch

Used to select AT or ATX power mode

CFast and SIM card

Used to insert a CFast card and SIM card

COM port

COM 1 and COM 2 support RS232/422/485 serial device

Expandable I/O bracket

Used to customized I/O output

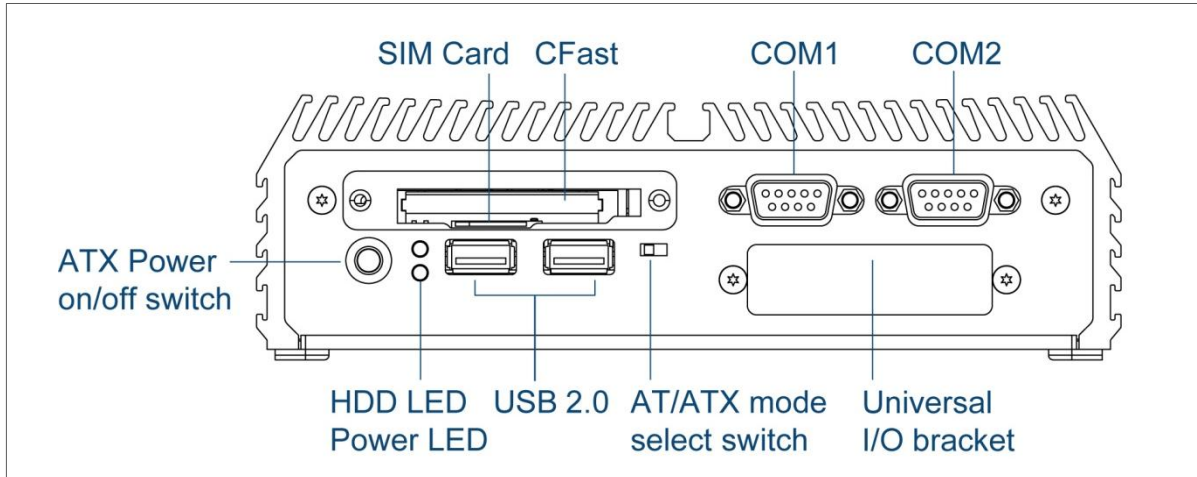

1.3.2 Rear Panel

DC IN

Used to plug a DC power input with terminal block

DVI-I port

Used to connect a DVI monitor or connect optional split cable for dual display mode

LAN port

Used to connect the system to a local area network

USB 3.0 port

Used to connect USB 3.0/2.0/1.1 device

USB 2.0 port

Used to connect USB 2.0/1.1 device

DisplayPort

Used to connect a DisplayPort monitor

Antenna hole

Used to connect an antenna for optional Mini-PCIe WiFi module

COM port

COM 3 and COM 4 support RS232/422/485 serial device

Mic-in

Used to connect a microphone

Speaker-out

Used to connect a speaker

Digital I/O Terminal Block

The Digital I/O terminal block supports 4 digital input and 4 digital output

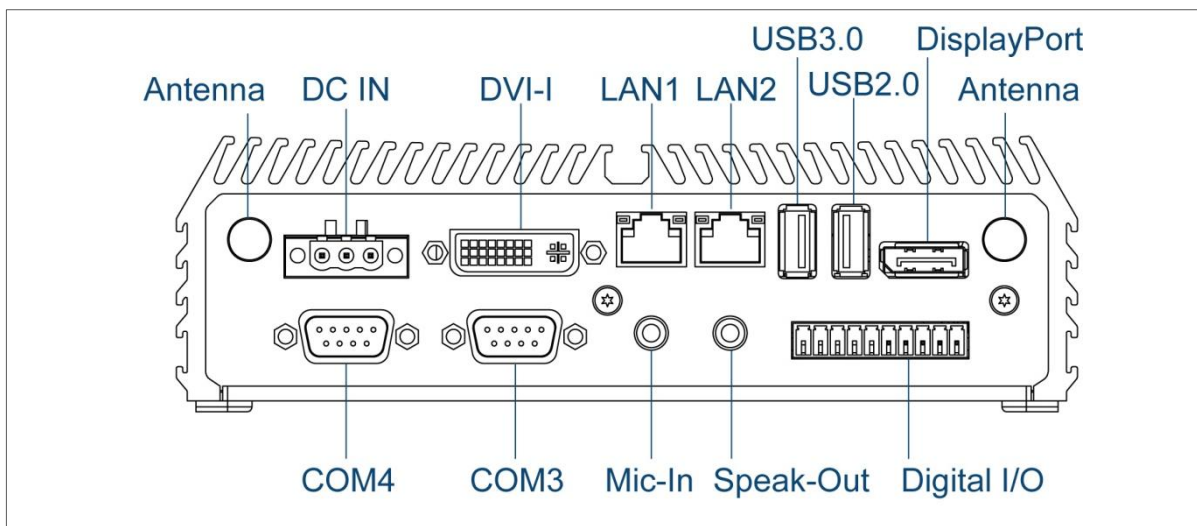

1.4 Mechanical Dimensions

Unit: mm

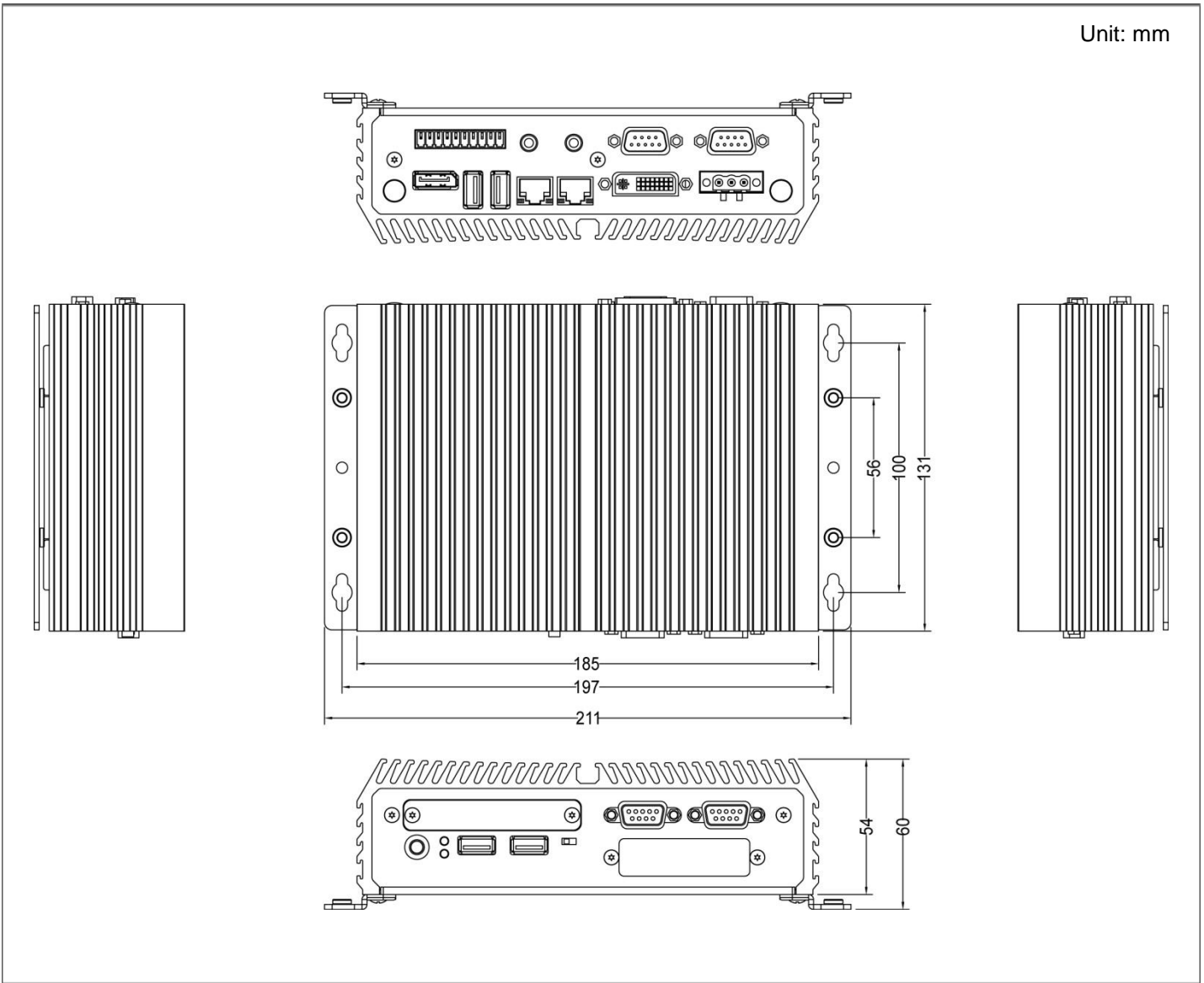



Chapter 2

Jumpers and Connectors

2.1 Jumpers Settings

When setting the jumpers, ensure that the jumper caps are placed on the correct pins. When the jumper cap is placed on both pins, the jumper is **short**. If you remove the jumper cap, or place the jumper cap on just one pin, the jumper is **open**. Refer to below for examples of the 2-pin and 3-pin jumpers when they are short (on) and open (off).

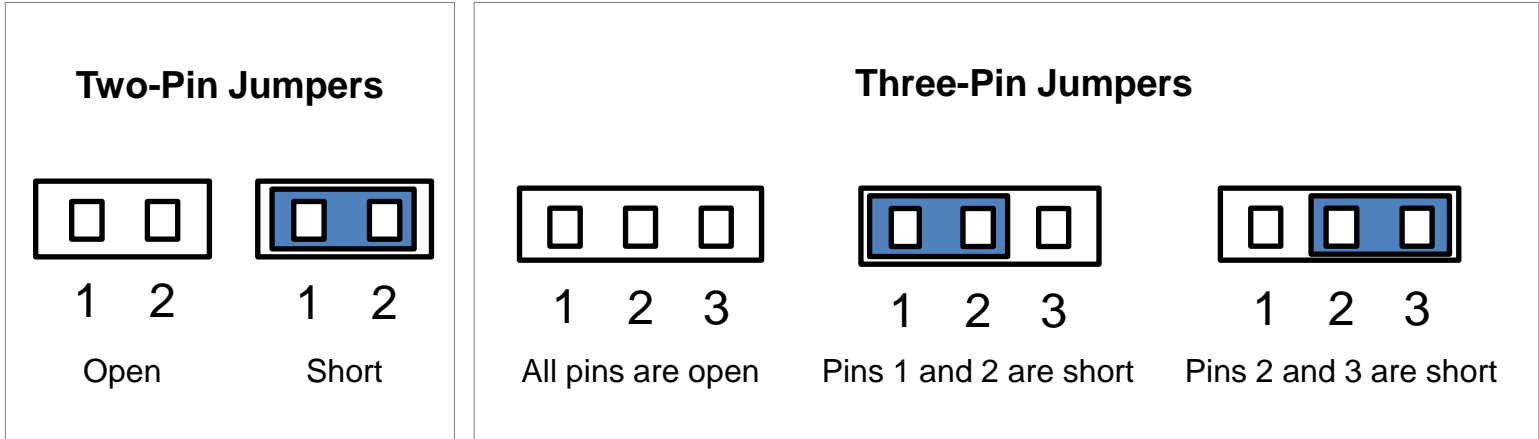

2.2 Locations of the Jumpers and Connectors

2.2.1 Top View

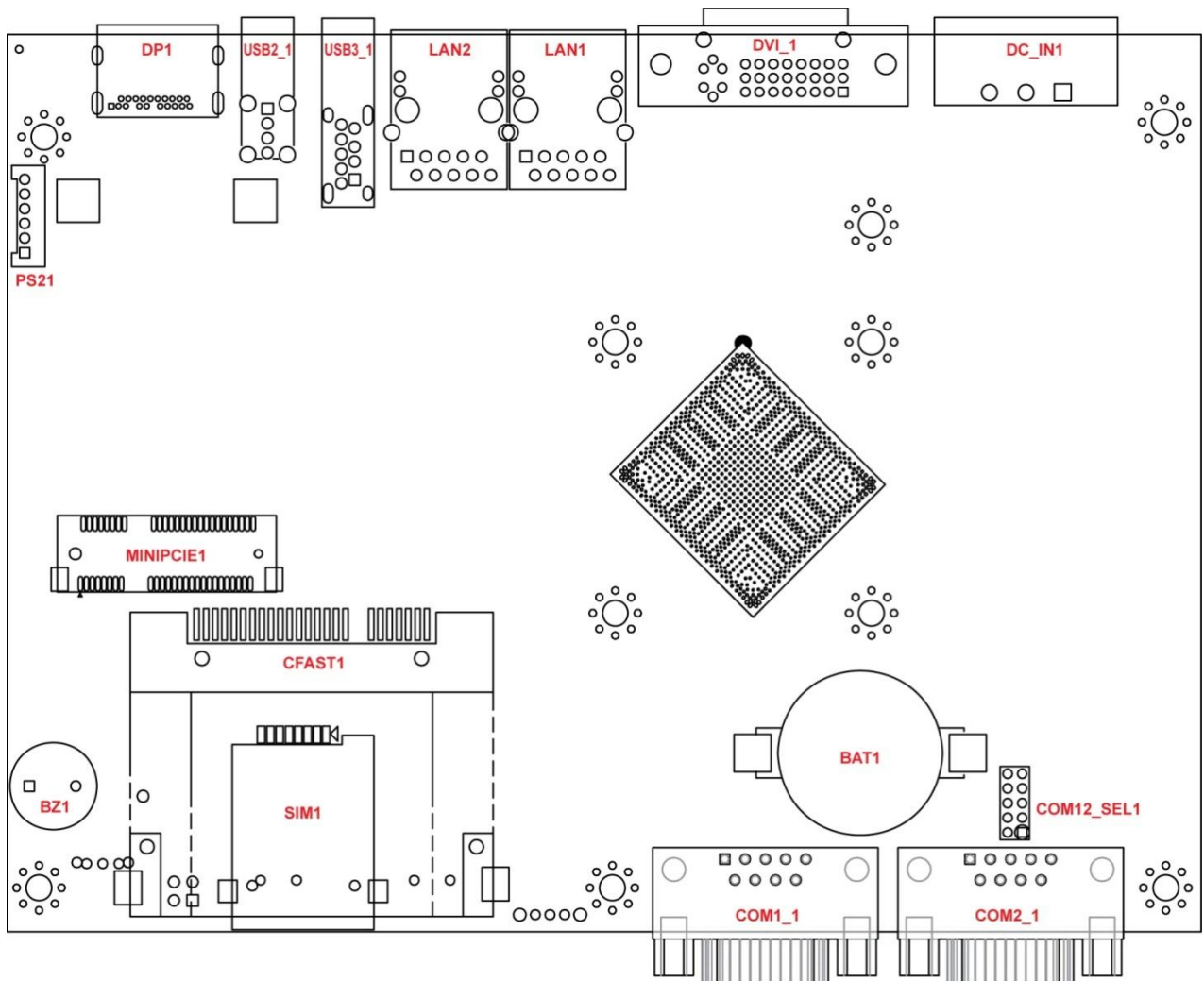

2.2.2 Bottom View

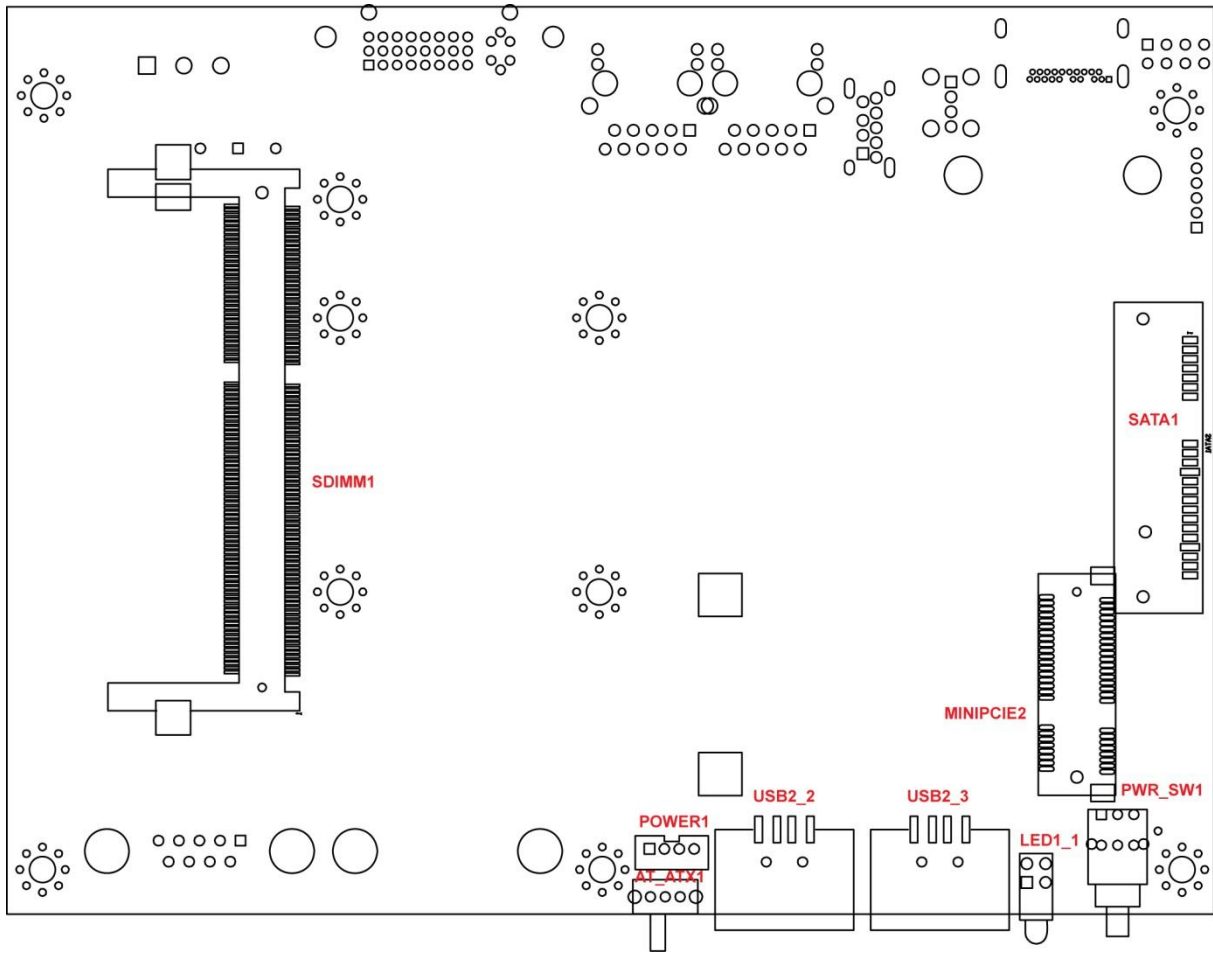

2.2.3 Daughter board view

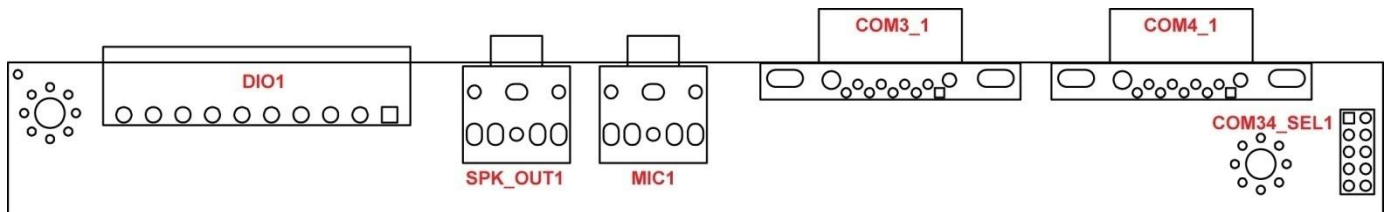

2.3 Connector / Jumper / Switch Definition

List of Connector / Jumper / Switch

Connector Location	Definition
AT_ATX1	AT / ATX Power Mode Switch
CFAST1	CFAST Connector
CLR_CMOS1	Clear BIOS Switch
COM1_1, COM2_1, COM3_1, COM4_1	RS232 / RS422 / RS485 Connector
COM12_SEL1, COM34_SEL1	COM1 / COM2 / COM3 / COM4 with Power Select
DC_IN1	3-pin DC 9~48V Power Input Connector
DIO1	4DI / 4DO Connector
DP1	DisplayPort Connector
DVI_I1	DVI-I Connector
LAN1, LAN2	LAN Port
LED1	Power / HDD Access LED Status
MIC1	Mic-in Jack
MINIPCI1, MINIPCI2	Mini PCI-Express Socket
POWER1	Power Connector
PS2_1	Keyboard / Mouse Connector
PWR_SW1	Power Switch
SATA1	SATA with Power Connector
SIM1	SIM Card Socket
SPK_OUT1	Speaker-out Jack
USB2_1, USB2_2, USB2_3	USB 2.0 Port
USB3_1	USB 3.0 Port

2.4 Switches Definitions

AT_ATX1: AT / ATX Power Mode Switch

Switch	Definition
1-2 (Right)	ATX Power Mode (Default)
2-3 (Left)	AT Power Mode

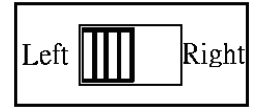

CLR_CMOS1: Clear BIOS Switch

Switch	Definition
Off	Normal Status (Default)
ON	Clear BIOS



2.5 Jumpers Definitions

COM12_SEL1: COM1 / COM2 with Power Select

Connector Type: 2X5 10-pin Header, 2.0mm pitch

COM1		COM2	
Pin	Definition	Pin	Definition
1-3 On	+5V	2-4 On	+5V
3-5 On	+12V	4-6 On	+12V
7-9 On (Default)	RI1	8-10 On (Default)	RI2

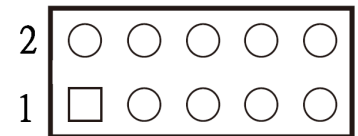

COM34_SEL1: COM3 / COM4 with Power Select

Connector Type: 2X5 10-pin Header, 2.0mm pitch

COM3		COM4	
Pin	Definition	Pin	Definition
1-3 On	+5V	2-4 On	+5V
3-5 On	+12V	4-6 On	+12V
7-9 On (Default)	RI3	8-10 On (Default)	RI4

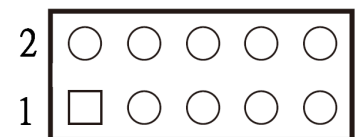

2.6 Connectors Definitions

CFAST1: CFast (Cerebrospinal Fluid Artifact Suppression Technique) Connector

Pin	Definition	Pin	Definition	Pin	Definition
S1	GND	PC1	NC	PC10	NC
S2	SATA_TX2+	PC2	GND	PC11	NC
S3	SATA_TX2-	PC3	NC	PC12	NC
S4	GND	PC4	NC	PC13	+3.3V
S5	SATA_RX2-	PC5	NC	PC14	+3.3V
S6	SATA_RX2+	PC6	NC	PC15	GND
S7	GND	PC7	GND	PC16	GND
		PC8	NC	PC17	NC
		PC9	NC		

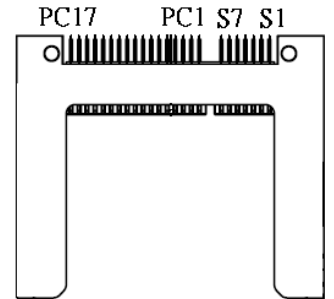

COM1_1: RS232 / RS422 / RS485 Connector

Connector Type: 9-pin D-Sub

Pin	RS232 Definition	RS422 / 485 Full Duplex Definition	RS485 Half Duplex Definition
1	DCD1	TX1-	DATA1-
2	RxD1	TX1+	DATA1+
3	TxD1	RX1+	
4	DTR1	RX1-	
5	GND1		
6	DSR1		
7	RTS1		
8	CTS1		
9	RI1		

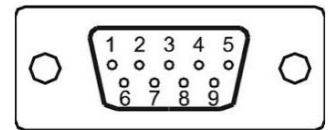

COM2_1: RS232 / RS422 / RS485 Connector

Connector Type: 9-pin D-Sub

Pin	RS232 Definition	RS422 / 485 Full Duplex Definition	RS485 Half Duplex Definition
1	DCD2	TX2-	DATA2-
2	RxD2	TX2+	DATA2+
3	TxD2	RX2+	
4	DTR2	RX2-	
5	GND2		
6	DSR2		
7	RTS2		
8	CTS2		
9	RI2		

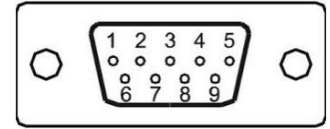
**COM3_1: RS232 / RS422 / RS485 Connector**

Connector Type: 9-pin D-Sub

Pin	RS232 Definition	RS422 / 485 Full Duplex Definition	RS485 Half Duplex Definition
1	DCD3	TX3-	DATA3-
2	RxD3	TX3+	DATA3+
3	TxD3	RX3+	
4	DTR3	RX3-	
5	GND3		
6	DSR3		
7	RTS3		
8	CTS3		
9	RI3		

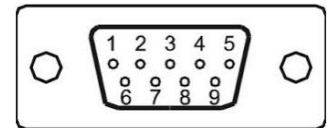

COM4_1: RS232 / RS422 / RS485 Connector

Connector Type: 9-pin D-Sub

Pin	RS232 Definition	RS422 / 485 Full Duplex Definition	RS485 Half Duplex Definition
1	DCD4	TX4-	DATA4-
2	RxD4	TX4+	DATA4+
3	TxD4	RX4+	
4	DTR4	RX4-	
5	GND4		
6	DSR4		
7	RTS4		
8	CTS4		
9	RI4		

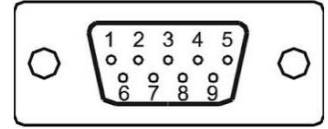
**DC_IN1: DC Power Input Connector (+9~48V)**

Connector Type: Terminal Block 1X3 3-pin, 5.0mm pitch

Pin	Definition
1	+9~48VIN
2	Chassis GND
3	GND

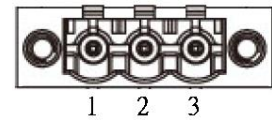
**DIO1: Digital Input / Output Connector**

Connector Type: Terminal Block 1X10 10-pin, 3.5mm pitch

Pin	Definition	Pin	Definition
1	DC INPUT	6	DO1
2	DI1	7	DO2
3	DI2	8	DO3
4	DI3	9	DO4
5	DI4	10	GND

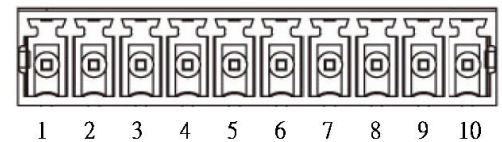

Reference Input Circuit

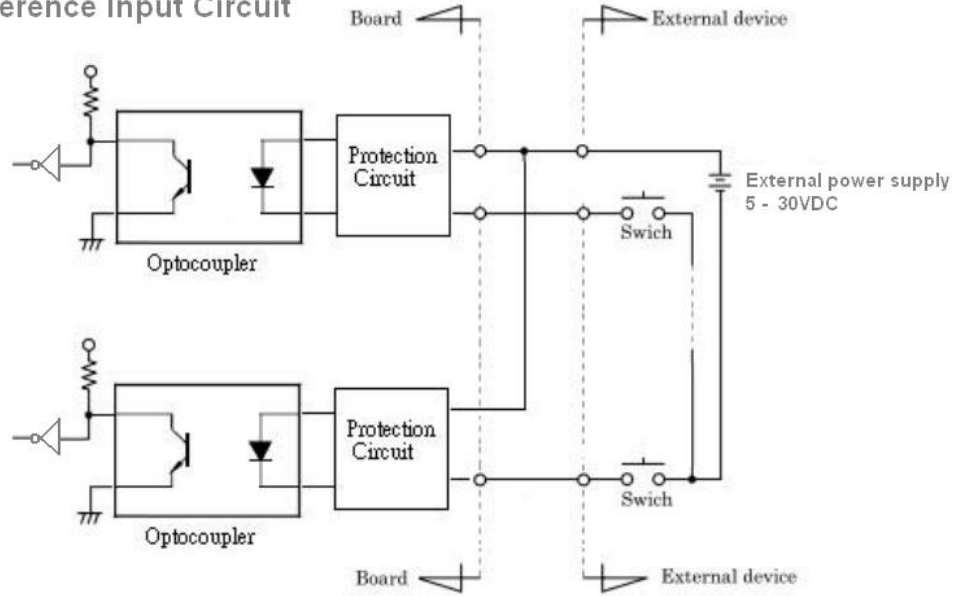

External Output Circuit

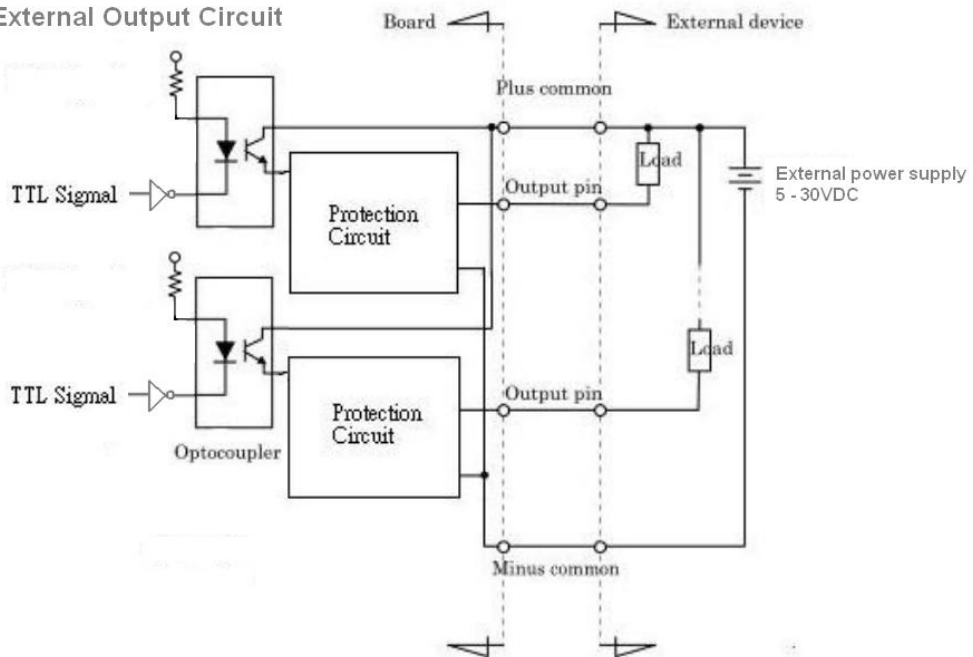

Digital Input Wiring

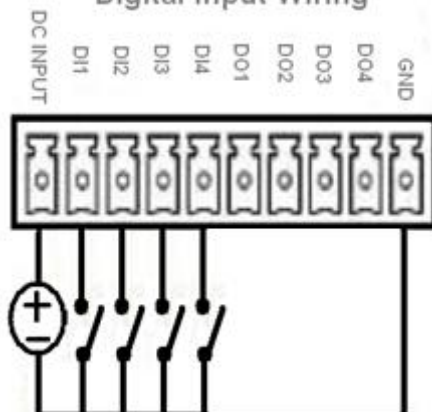

Digital Output Wiring

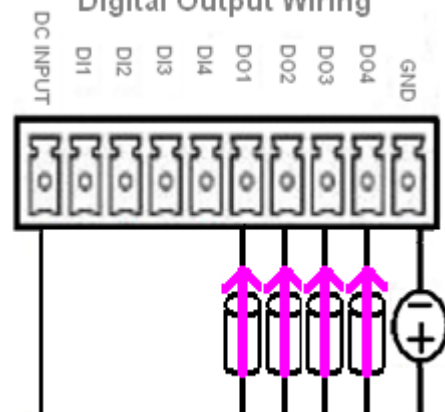

DP1: DisplayPort Connector

Pin	Definition	Pin	Definition
1	DP_LANE0_P	11	GND
2	GND	12	DP_LANE3_N
3	DP_LANE0_N	13	GND
4	DP_LANE1_P	14	GND
5	GND	15	DP_AUX_P
6	DP_LANE1_N	16	GND
7	DP_LANE2_P	17	DP_AUX_N
8	GND	18	DP_HPDP
9	DP_LANE2_N	19	GND
10	DP_LANE3_P	20	DP_PWR

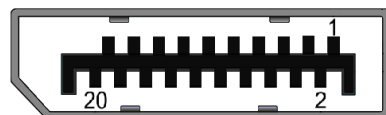
**DVI_I1: DVI-I Connector**

Pin	Definition	Pin	Definition
1	DVI_TX2-	16	DVI Hot Plug Detect
2	DVI_TX2+	17	DVI_TX0-
3	GND	18	DVI_TX0+
4	NC	19	GND
5	NC	20	NC
6	DDC_CLOCK	21	NC
7	DDC_DATA	22	GND
8	VGA_VSYNC	23	DVI_TXCLK+
9	DVI_TX1-	24	DVI_TXCLK-
10	DVI_TX1+	C1	VGA_RED
11	GND	C2	VGA_GREEN
12	NC	C3	VGA_BLUE
13	NC	C4	VGA_HSYNC
14	+5V	C5	GND
15	GND		

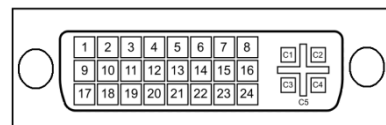

LAN1: RJ45 with LEDs Port

Pin	Definition	Pin	Definition
1	LAN1_MDI0P	5	LAN1_MDI2N
2	LAN1_MDI0N	6	LAN1_MDI1N
3	LAN1_MDI1P	7	LAN1_MDI3P
4	LAN1_MDI2P	8	LAN1_MDI3N

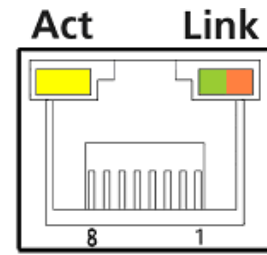

Act LED Status	Definition	Link LED Status	Definition
Blinking Yellow	Data Activity	Steady Green	1Gbps Network Link
Off	No Activity	Steady Orange	100Mbps Network Link
		Off	10Mbps Network Link

LAN2: RJ45 with LEDs Port

Pin	Definition	Pin	Definition
1	LAN2_MDI0P	5	LAN2_MDI2N
2	LAN2_MDI0N	6	LAN2_MDI1N
3	LAN2_MDI1P	7	LAN2_MDI3P
4	LAN2_MDI2P	8	LAN2_MDI3N

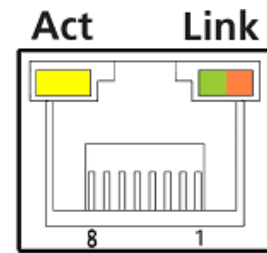

Act LED Status	Definition	Link LED Status	Definition
Blinking Yellow	Data Activity	Steady Green	1Gbps Network Link
Off	No Activity	Steady Orange	100Mbps Network Link
		Off	10Mbps Network Link

LED1: Power / HDD Access LED Status

Pin	Definition
1	HDD LED+
2	HDD LED-
3	POWER LED+
4	POWER LED-

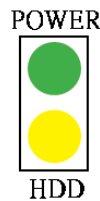

LED Status	LED Color
HDD	Yellow
POWER	Green

SPK_OUT1 : Speaker-out Jack (Green)

Connector Type: 5-pin Phone Jack

Pin	Definition
1	GND
2	OUT_R
3	NC
4	GND
5	OUT_L

**MIC1: Microphone Jack (Pink)**

Connector Type: 5-pin Phone Jack

Pin	Definition
1	GND
2	MIC_R
3	NC
4	GND
5	MIC_L

**MINIPCIE1: Mini PCI-Express Socket**

Pin	Definition	Pin	Definition	Pin	Definition
1	WAKE#	19	NC	37	GND
2	+3.3V	20	+3.3V	38	USB2_3P
3	NC	21	GND	39	+3.3V
4	GND	22	MINIPCIE_RST#	40	GND
5	NC	23	MINIPCIE_RXN	41	+3.3V
6	+1.5V	24	+3.3V	42	NC
7	CLKREQ#	25	MINIPCIE_RXP	43	GND
8	UIM_PWR	26	GND	44	NC
9	GND	27	GND	45	NC
10	UIM_DATA	28	+1.5V	46	NC
11	MINIPCIE_CLKN	29	GND	47	NC
12	UIM_CLK	30	SMB_CLK	48	+1.5V
13	MINIPCIE_CLKP	31	MINIPCIE_TXN	49	NC
14	UIM_RESET	32	SMB_DATA	50	GND
15	GND	33	MINIPCIE_TXP	51	NC
16	UIM_VPP	34	GND	52	+3.3V
17	NC	35	GND		
18	GND	36	USB2_3N		

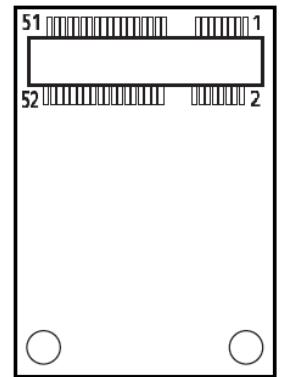

MINIPCIE2: Mini PCI-Express Socket

Pin	Definition	Pin	Definition	Pin	Definition
1	WAKE#	19	NC	37	GND
2	+3.3V	20	+3.3V	38	USB_2P
3	NC	21	GND	39	+3.3V
4	GND	22	MINIPCIE_RST#	40	GND
5	NC	23	MINIPCIE_RXN	41	+3.3V
6	+1.5V	24	+3.3V	42	NC
7	CLKREQ#	25	MINIPCIE_RXP	43	GND
8	NC	26	GND	44	NC
9	GND	27	GND	45	NC
10	NC	28	+1.5V	46	NC
11	MINIPCIE_CLKN	29	GND	47	NC
12	NC	30	SMB_CLK	48	+1.5V
13	MINIPCIE_CLKP	31	MINIPCIE_TXN	49	NC
14	NC	32	SMB_DATA	50	GND
15	GND	33	MINIPCIE_TXP	51	NC
16	NC	34	GND	52	+3.3V
17	NC	35	GND		
18	GND	36	USB_2N		

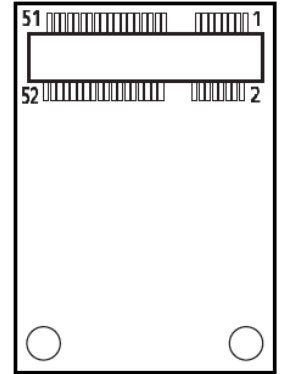
**POWER1: Power Connector**

Connector Type: 1X4-pin Wafer, 2.0mm pitch

Pin	Definition
1	+5V
2	GND
3	GND
4	+12V

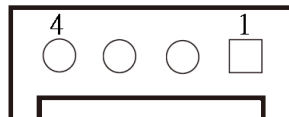
**PS2_1: Keyboard / Mouse Connector**

Connector Type: 1X6-pin Wafer, 2.0mm pitch

Pin	Definition
1	MSDAT
2	KBDAT
3	GND
4	+5V
5	MSCLK
6	KBCLK



PWR_SW1: Power Switch

Pin	Definition
1	NC
2	Power Button
3	NC
4	GND
5	NC
6	GND

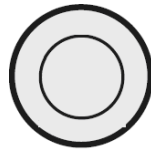
**SATA1: SATA with Power Connector**

Pin	Definition	Pin	Definition
1	GND	12	GND
2	SATA_TX1+	13	GND
3	SATA_TX1-	14	+5V
4	GND	15	+5V
5	SATA_RX1-	16	+5V
6	SATA_RX1+	17	GND
7	GND	18	GND
8	+3.3V	19	GND
9	+3.3V	20	+12V
10	+3.3V	21	+12V
11	GND	22	+12V

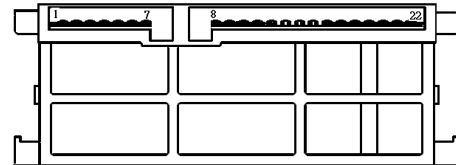
**SIM1 : SIM Card Socket**

Pin	Definition
C1	UIM_PWR
C2	UIM_RESET
C3	UIM_CLK
C5	GND
C6	UIM_VPP
C7	UIM_DATA
CD	NC
COM	GND

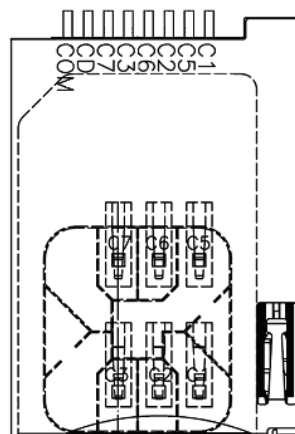

USB2_1: USB2.0 Connector, Type A

Pin	Definition
1	+5V
2	USB_DATA0-
3	USB_DATA0+
4	GND

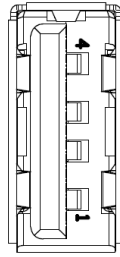
**USB2_2, USB2_3: USB2.0 Connector, Type A**

Pin	USB2_2 Definition	USB2_3 Definition
1	+5V	+5V
2	USB_DATA2-	USB_DATA3-
3	USB_DATA2+	USB_DATA3+
4	GND	GND

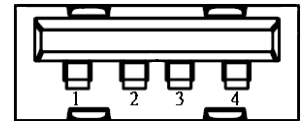
**USB3_1: USB 3.0 Connector, Type A**

Pin	Definition	Pin	Definition
1	+5V	6	USB3_RX+
2	USB2_DATA-	7	GND
3	USB2_DATA+	8	USB3_TX-
4	GND	9	USB3_TX+
5	USB3_RX-		

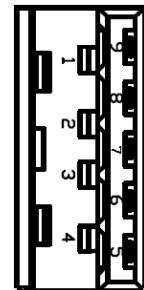



Chapter 3

System Setup

3.1 Removing the Chassis Bottom Cover



WARNING

In order to prevent electric shock or system damage, before removing the chassis cover, must turn off power and disconnect the unit from power source.

1. Turn over the unit to have the bottom side face up, loosen the 4 screws of bottom cover and place them aside.



2. Remove the cover from the chassis.



3.2 Removing the Chassis

1. Loosen the 3 screws as mark on photo and place them aside.

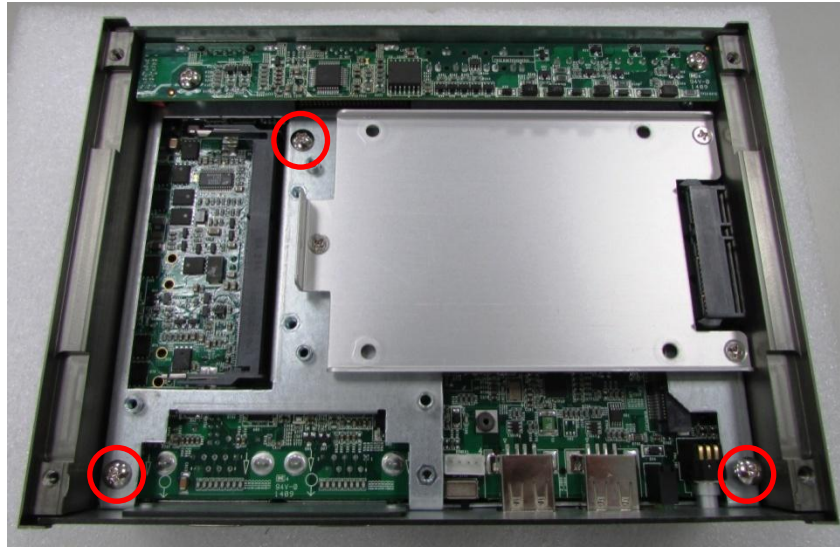

2. Hold front and rear panels and lift up the body of unit vertically.



3. Turn over the body of the unit and place it gently.



3.3 Installing a Half Size Mini PCIe Card on Top Side

1. Locate the Mini PCIe slot.

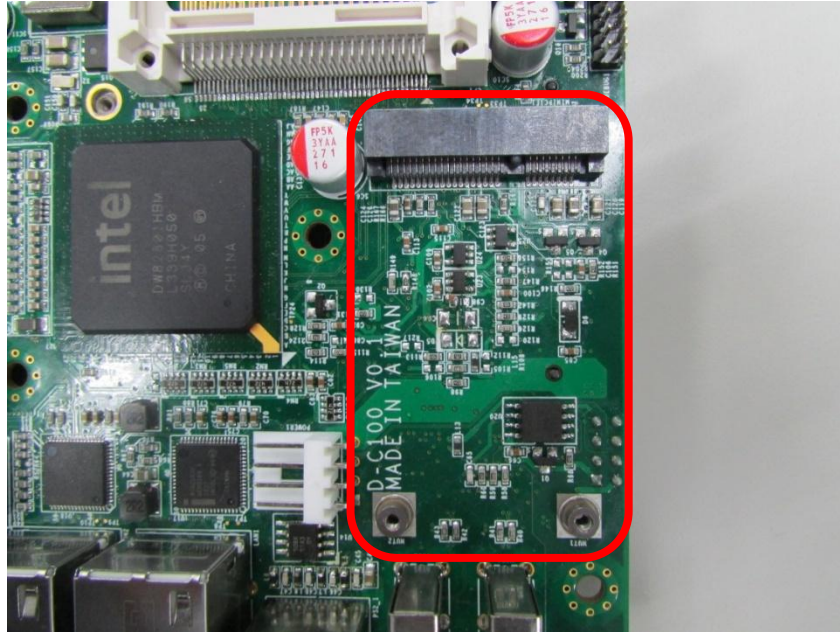

2. Use provided two screws on bracket to fasten the module and bracket together.



3. Tilt the Mini PCIe module at 45 degree angle and insert it to the slot until the gold-pated connector of module contacted firmly with the slot.

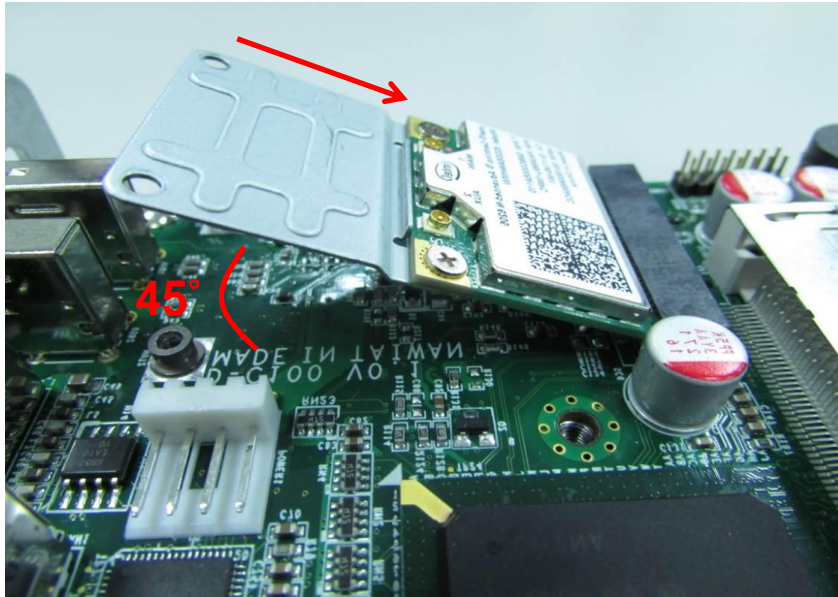

4. Press down the module and use the two screws to fix the module.

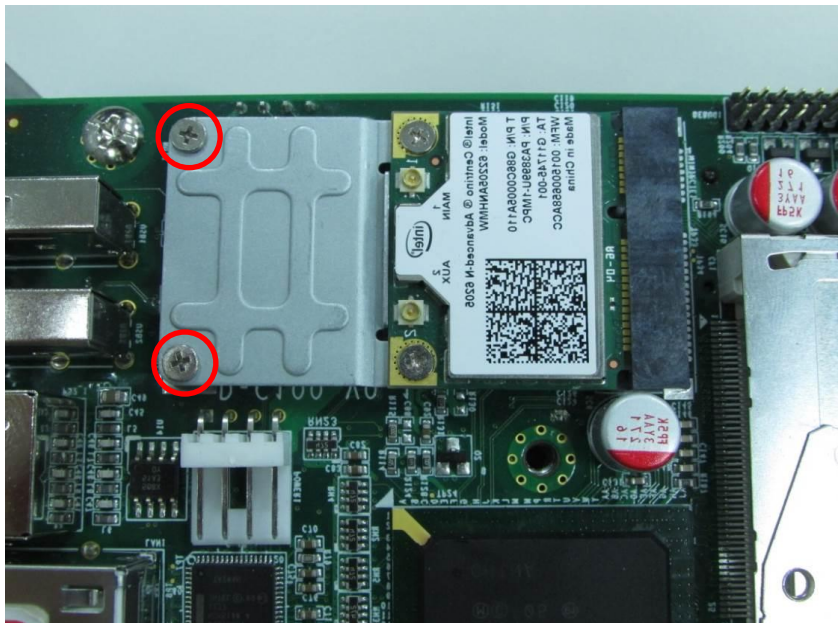

3.4 Installing a Full Size Mini PCIe Card on Top Side

1. Locate the Mini PCIe slot.

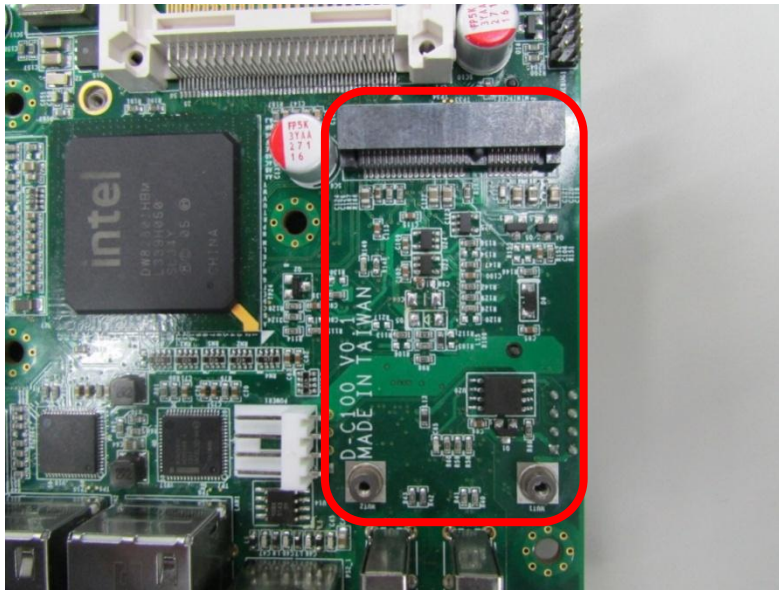

2. Tilt the Mini PCIe module at 45 degree angle and insert it to the slot until the gold-pated connector of module contacted firmly with the slot.

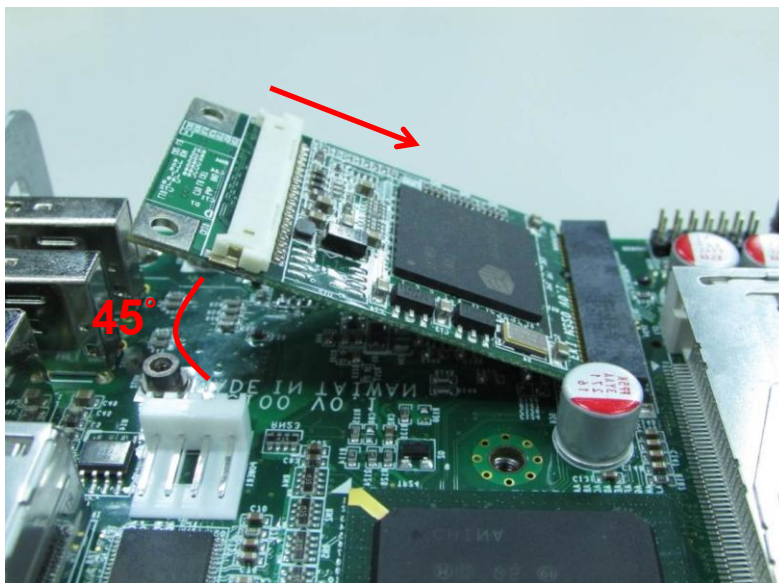

3. Press down the module and use the two screws to fix the module.

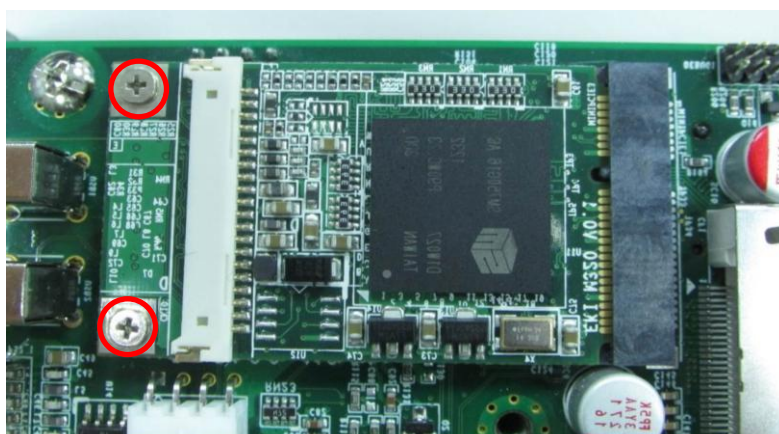

3.5 Installing Antennas

**CAUTION**

Please installing a Mini PCIe Wireless Lan Card on top side before you put on washer and fasten the nut with antenna jack.

1. Remove the antenna hole covers at rear panel.



2. Have antenna jack penetrate through the hole.



3. Put on washer and fasten the nut with antenna jack.



4. Assemble the antenna and antenna jack together.



5. Attach the RF connector at another end of cable onto the module.

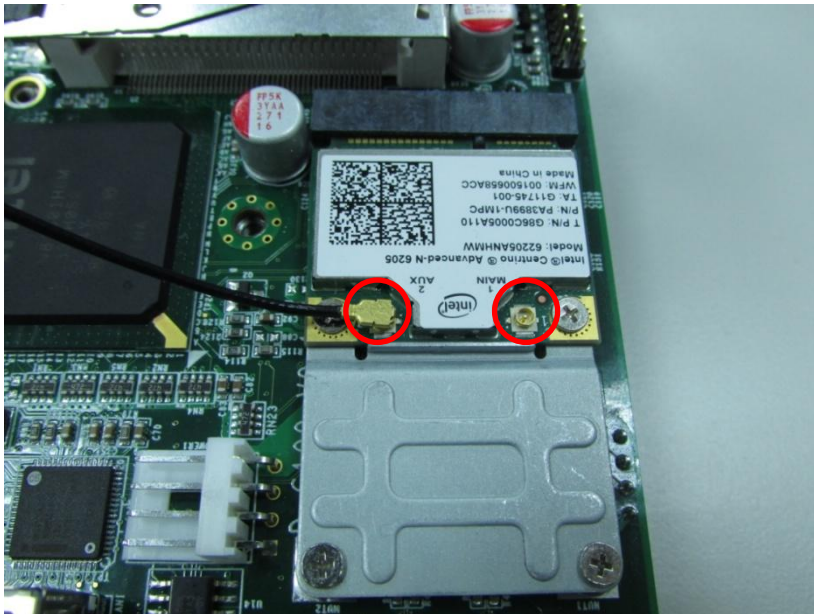

3.6 Installing a Half Size Mini PCIe Card on Bottom Side

1. Turn over the body of unit. Unscrew the 3 screws on HDD bracket and remove the bracket.

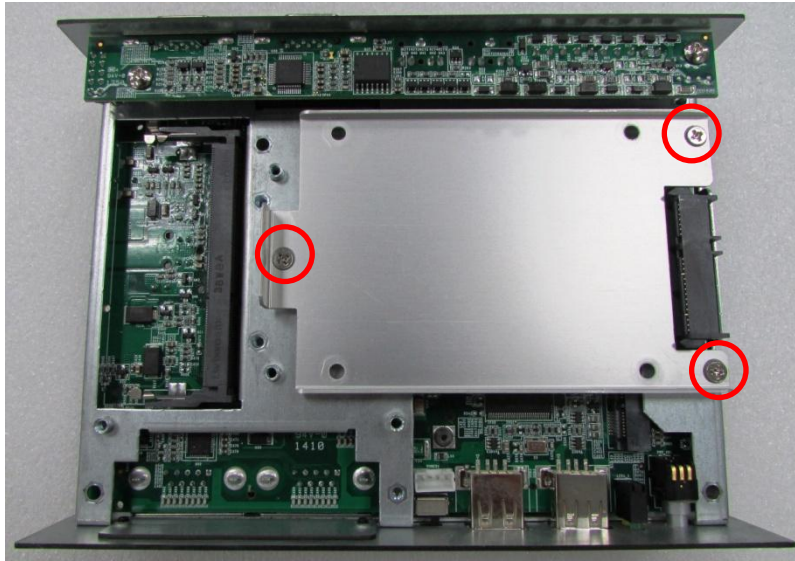

2. Locate the Mini PCIe slot.

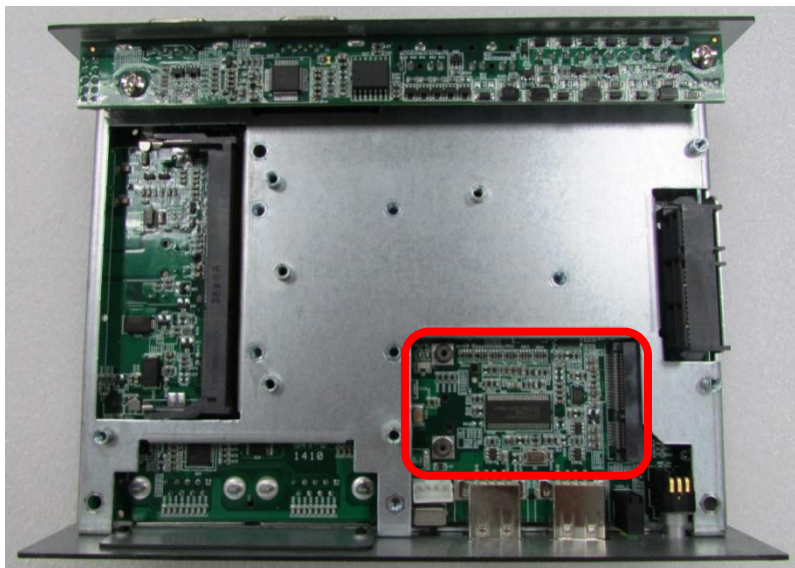

3. Use provided two screws on bracket to fasten the module and bracket together.

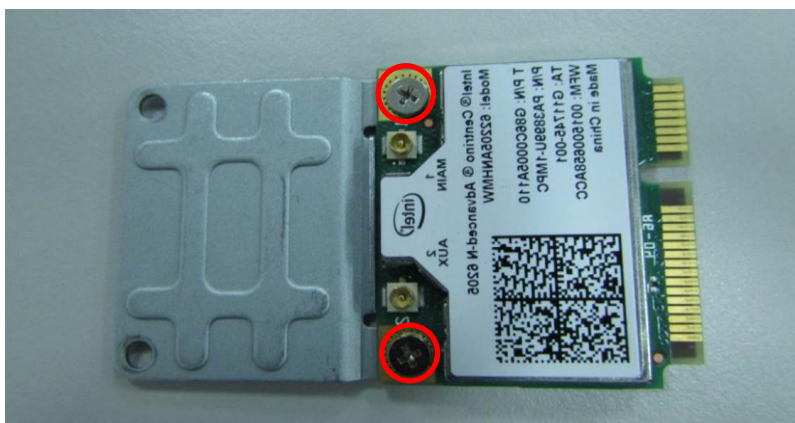

4. Tilt the Mini PCIe module at 45 degree angle and insert it to the slot until the gold-pated connector of module contacted firmly with the slot.



5. Press down the module and use the two screws to fix the module.

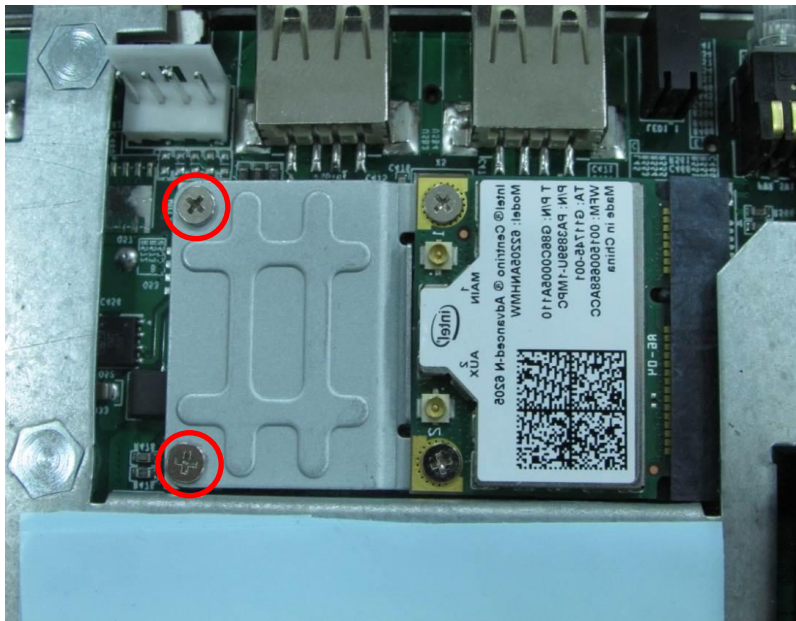

3.7 Installing a Full Size Mini PCIe Card on Bottom Side

1. Locate the Mini PCIe slot.

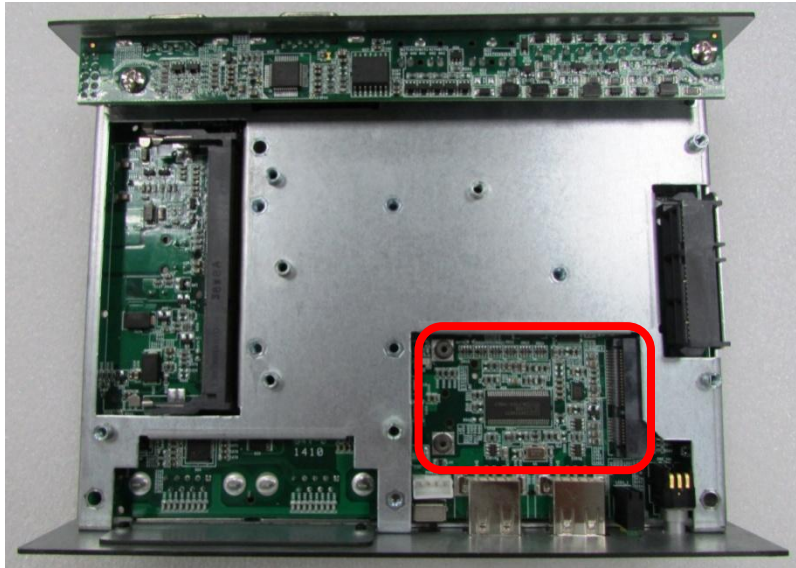

2. Tilt the Mini PCIe module at 45 degree angle and insert it to the slot until the gold-pated connector of module contacted firmly with the slot.

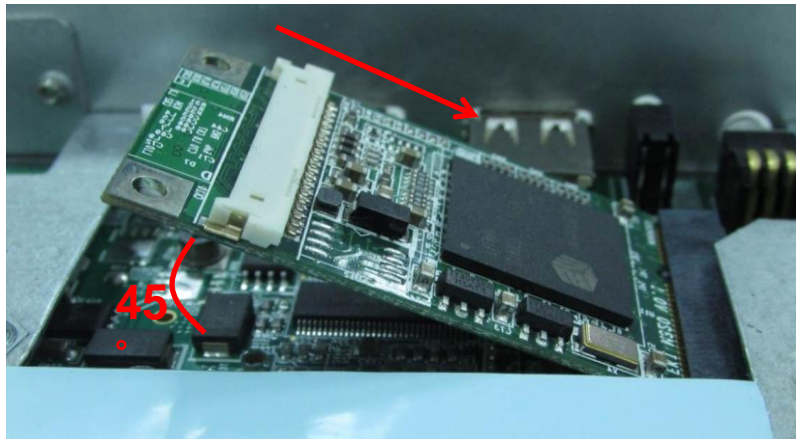

3. Press down the module and use the two screws to fix the module.

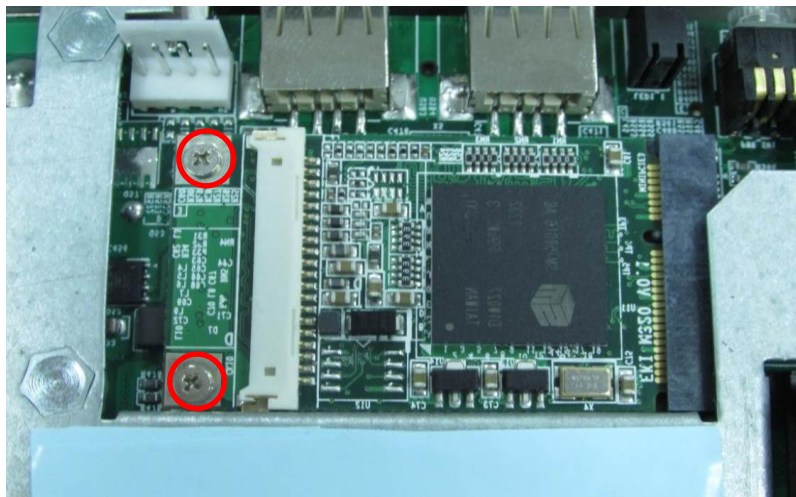

3.8 Installing a SATA Hard Drive

1. Lift up the empty HDD bracket by unscrewing the 3 screws.

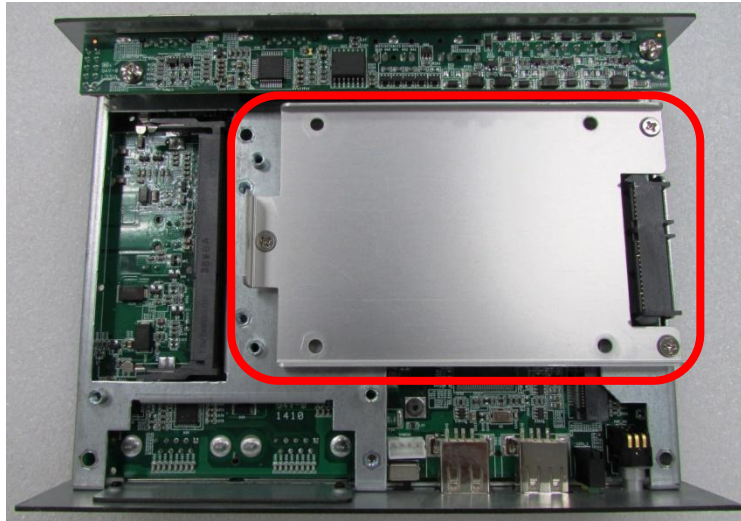

2. Make the PCB side of the HDD face up, place the HDD bracket on it. Ensure the direction of bracket is correct and use 4 provided screws to assemble HDD and HDD bracket together.

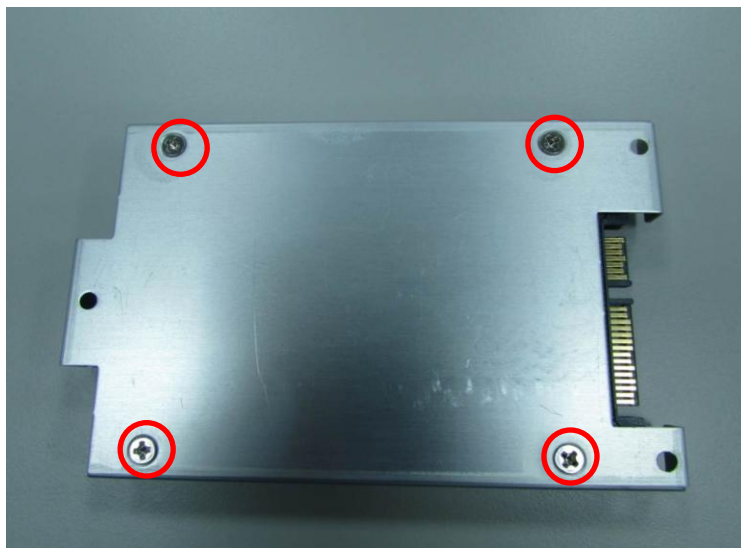

3. Turn over the HDD bracket. Connect the HDD bracket to the SATA connector of the unit and fasten the 3 screws.



3.9 Installing a SODIMM

1. Locate SODIMM socket.

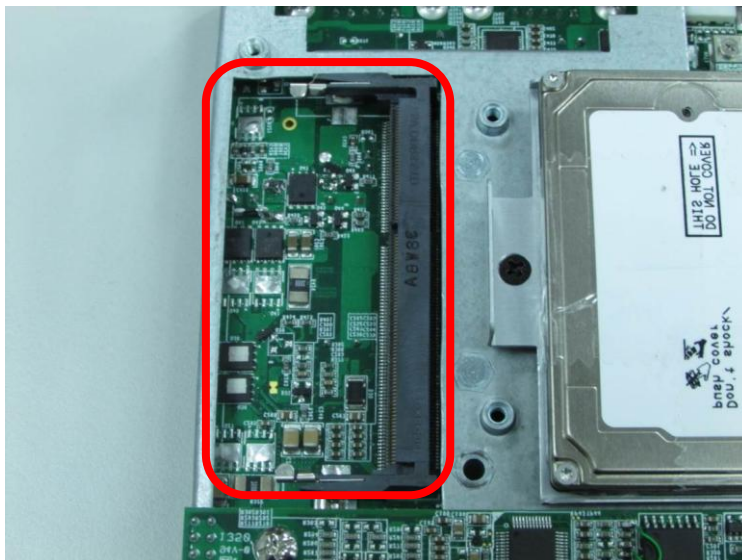

2. Tilt the SODIMM module at a 45 degree angle and insert it to SODIMM socket until the gold-pated connector of module contacted firmly with the socket.

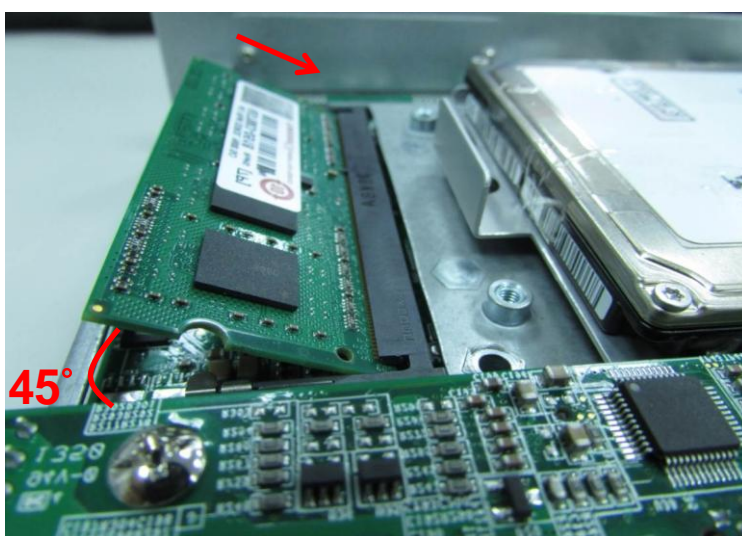

3. Press the module down until its fixed firmly by the two locking latches on the sides.



3.10 Installing the Chassis

1. Hold the body of unit, level the 3 screw holes with the hollow studs on the chassis.

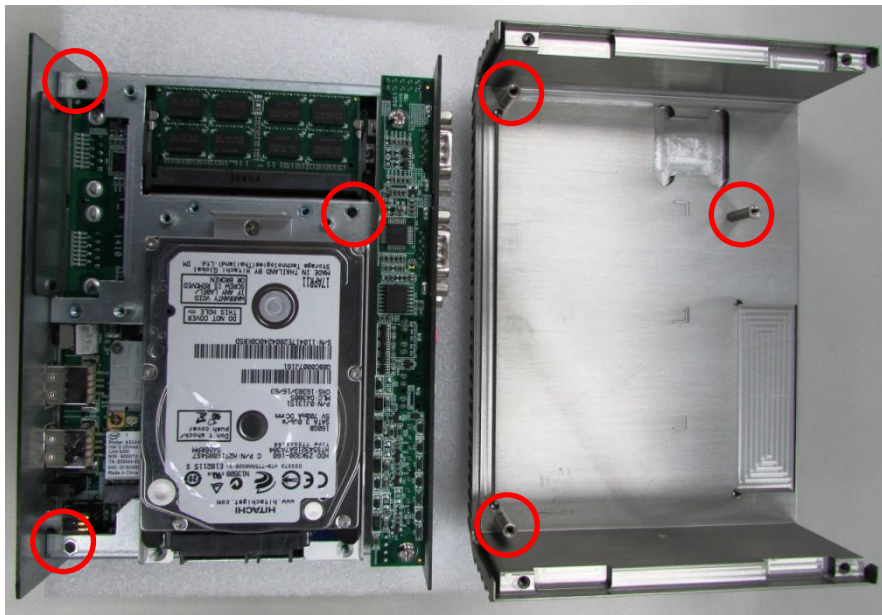

2. Make sure the either sides of front and rear panels are in the chassis grooves and insert the body of unit into Chassis. Use the 3 screws to fasten the body and chassis together.

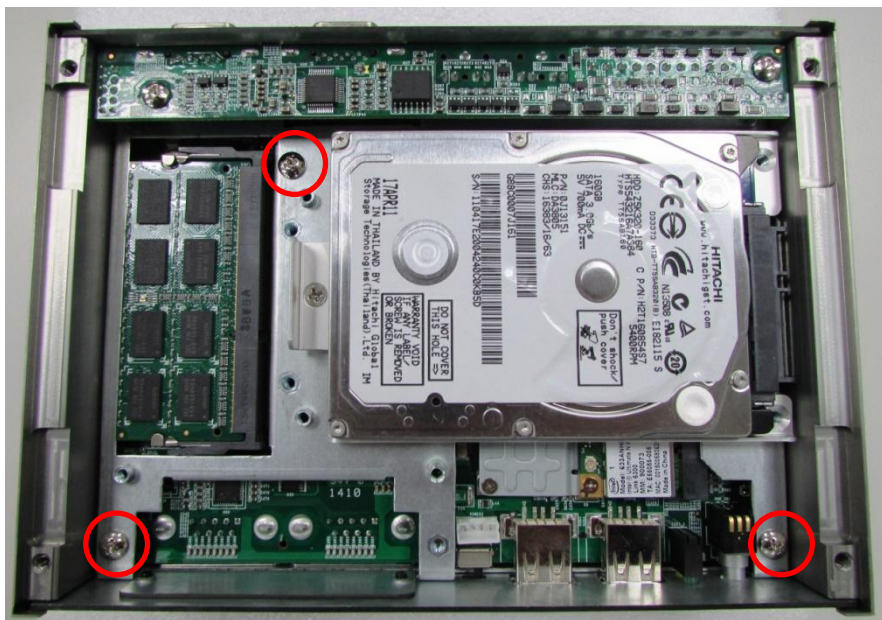

3.11 Installing the Chassis Bottom Cover

1. Level the grooves on bottom cover with front and rear panels. Put on the cover.



2. Fasten the 4 screws to fix the cover.

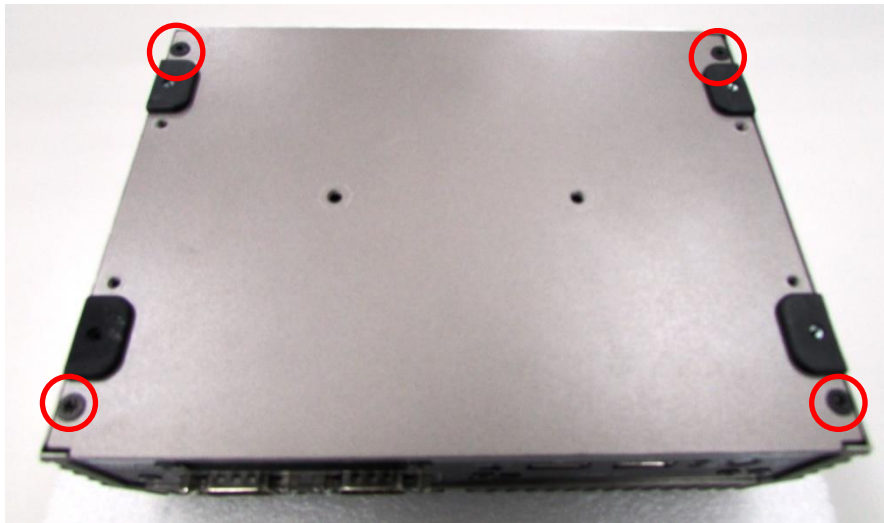

3.12 Installing a SIM Card

1. SIM card slot is at the front panel of the system.

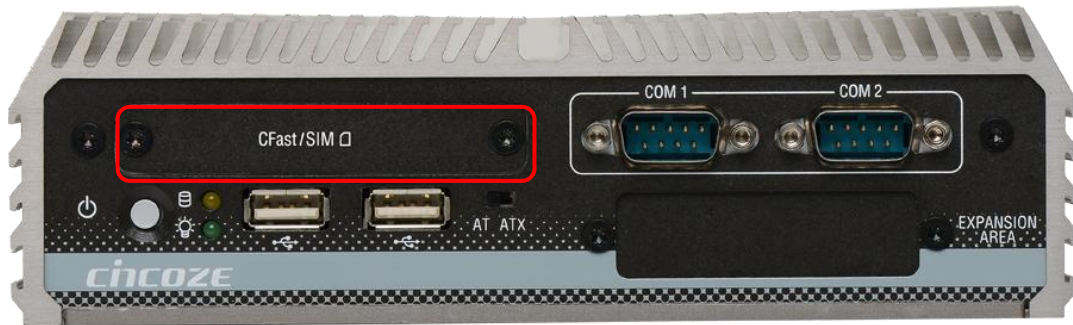

2. Remove the mounting cover by unscrewing the two screws.



3. Insert the SIM card.



3.13 Installing a CFast Card

1. Locate the CFast card slot.

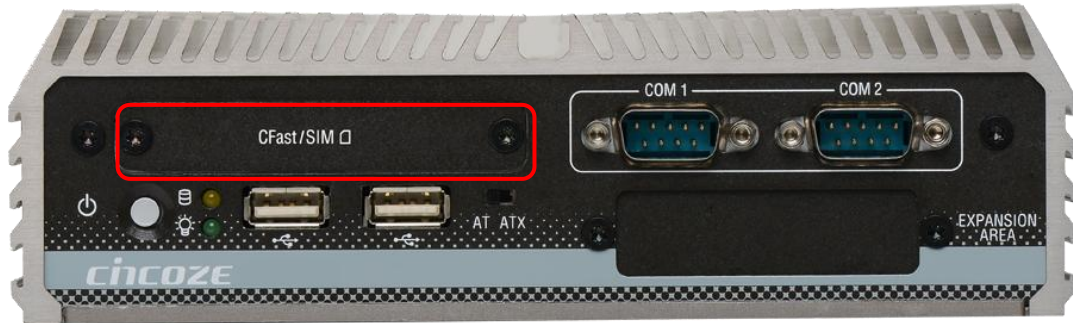

2. Remove the mounting cover by unscrewing the two screws.



3. Insert the CFast card.



3.14 Wall Mount Brackets

DC-1100 offers a wall mount option so that customers can install the system on the wall in a convenient and economical ways.



1. The mounting holes are at the bottom of system. Use provided 4 screws to fasten the bracket with each side of system together.



2. Fasten the screws through the bracket mounting hole to mount system on the wall.



3.15 Side Mount Bracket

DC-1100 offers a side mount option so that customers can install the system to the right or left side of wall to create effective of space.

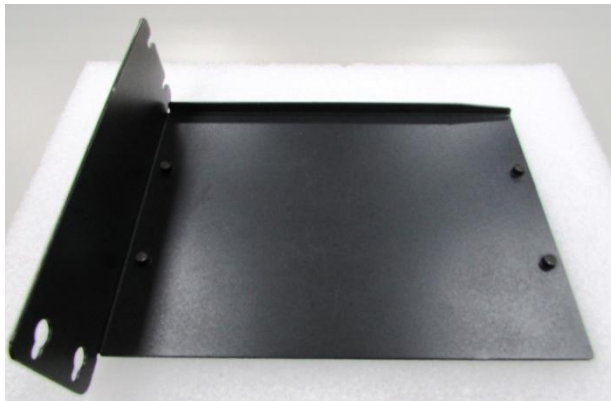

1. The mounting holes are at the bottom of system. Fasten the 4 screws to fix the side mount bracket with system together.

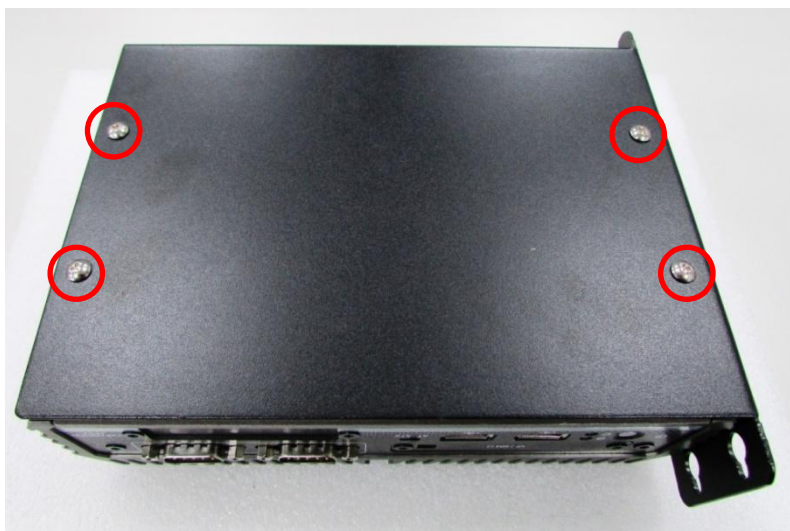

2. Fasten the screws through the bracket mounting hole to mount system on the wall.



3.16 VESA Mount Brackets

DC-1100 offers a VESA mount option so that customers can mount system with panel complying with VESA 75mm and 100 mm standard for various usage.



1. The mounting holes are at the bottom of system. Fasten the 4 screws to fix the first bracket with system.

2. Fasten the 4 screws through the second bracket mounting holes with panel.



3. Hang the system on the back of panel by using the hooks on second bracket.

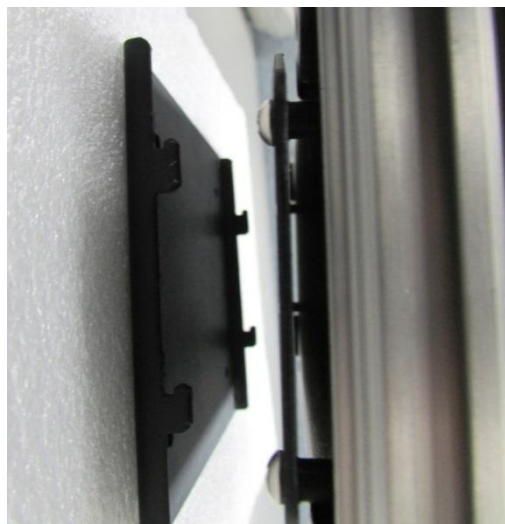

3.17 DIN-Rail Mount Bracket

DC-1100 offers a DIN-Rail mount option so that customers can install system on the DIN Rail.



1. The mounting holes are at the bottom of system. Fasten the 2 screws to fix the DIN-Rail mount bracket with system together.

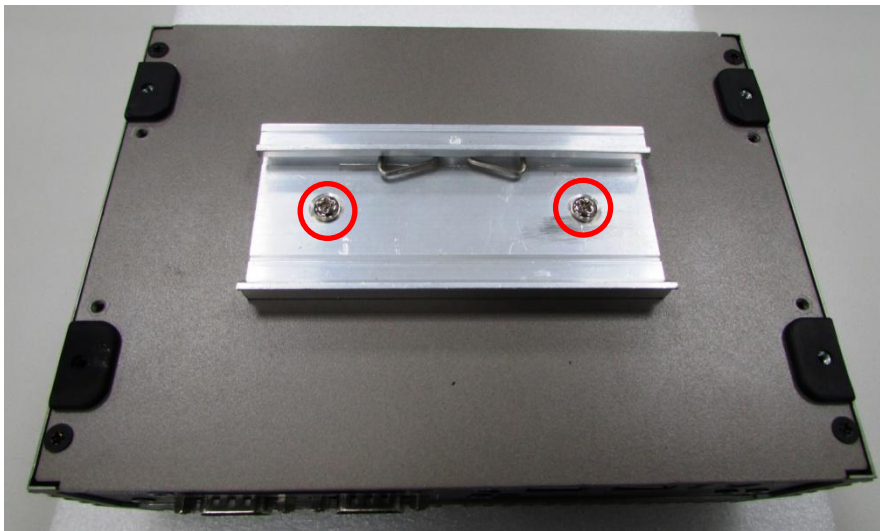



Chapter 4

BIOS Setup

4.1 BIOS Introduction

The BIOS (Basic Input/Output System) is a program located on a Flash Memory on the motherboard. When you start the computer, the BIOS program will gain control. The BIOS first operates an auto-diagnostic test called POST (power on self test) for all the necessary hardware, it detects the entire hardware device and configures the parameters of the hardware synchronization.

BIOS Setup

Power on the computer and by pressing immediately allows you to enter Setup. If the message disappears before your respond and you still wish to enter Setup, restart the system to try again by turning it OFF then ON or pressing <Ctrl>, <Alt> and <Delete> keys.

Control Keys	
<←> <→>	Move to select screen
<↑> <↓>	Move to select item
<Esc>	Quit the BIOS Setup
<Enter>	Select item
<Page Up/+>	Increases the numeric value or makes changes
<Page Down/->	Decreases the numeric value or makes changes
<Tab>	Select setup fields
<F1>	General help
<F2>	Previous value
<F3>	Load Optimized defaults
<F10>	Save configuration and Exit

Main Menu

The main menu lists the setup functions you can make changes to. You can use the arrow keys (↑↓) to select the item. The on-line description of the highlighted setup function is displayed at the bottom of the screen.

Sub-Menu

If you find a right pointer symbol appears to the left of certain fields that means a sub-menu can be launched from this field. A sub-menu contains additional options for a field parameter. You can use arrow keys (↑↓) to highlight the field and press <Enter> to call up the sub-menu. Then you can use the control keys to enter values and move from field to field within a sub-menu. If you want to return to the main menu, just press the <Esc >.

4.2 Main Setup

Press to enter BIOS CMOS Setup Utility, the Main Menu (as shown below) will appear on the screen. Use arrow keys to move among the items and press <Enter> to accept or enter a sub-menu.

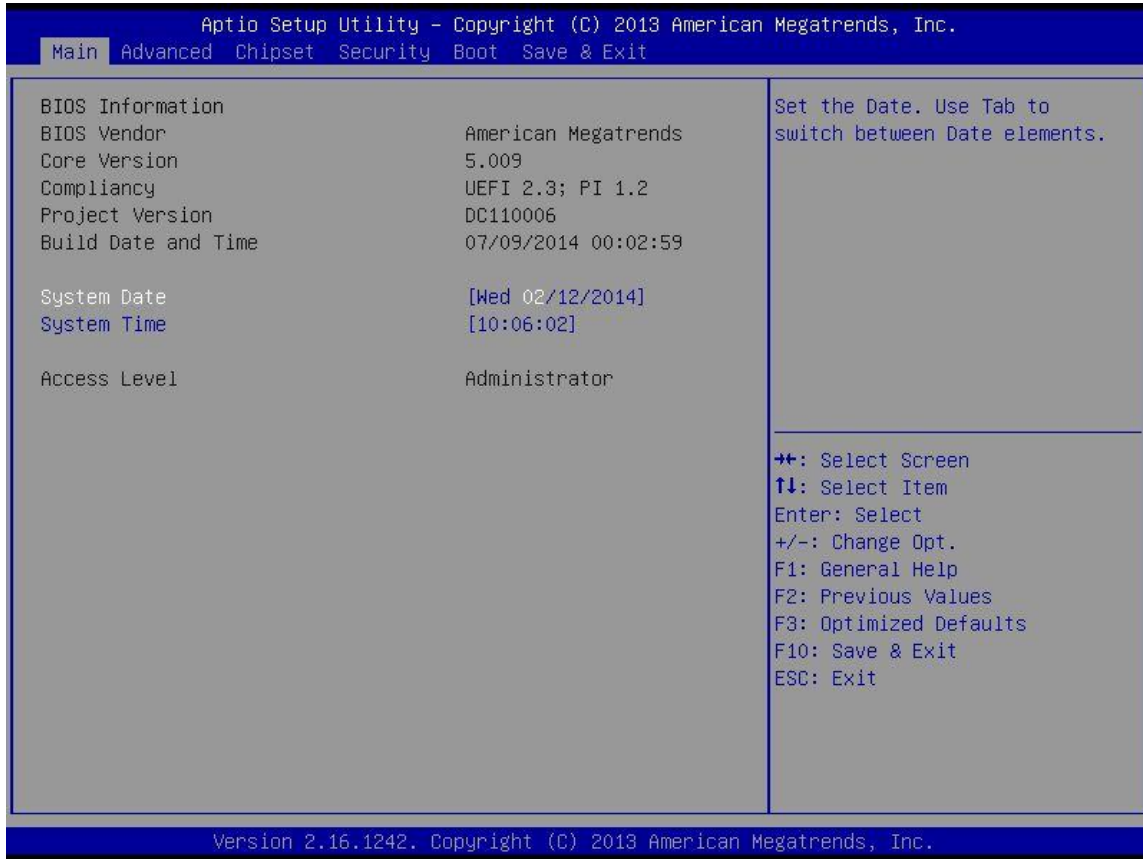

4.2.1 System Date

Set the date. Please use <Tab> to switch between data elements.

4.2.2 System Time

Set the time. Please use <Tab> to switch between time elements.

4.3 Advanced Setup

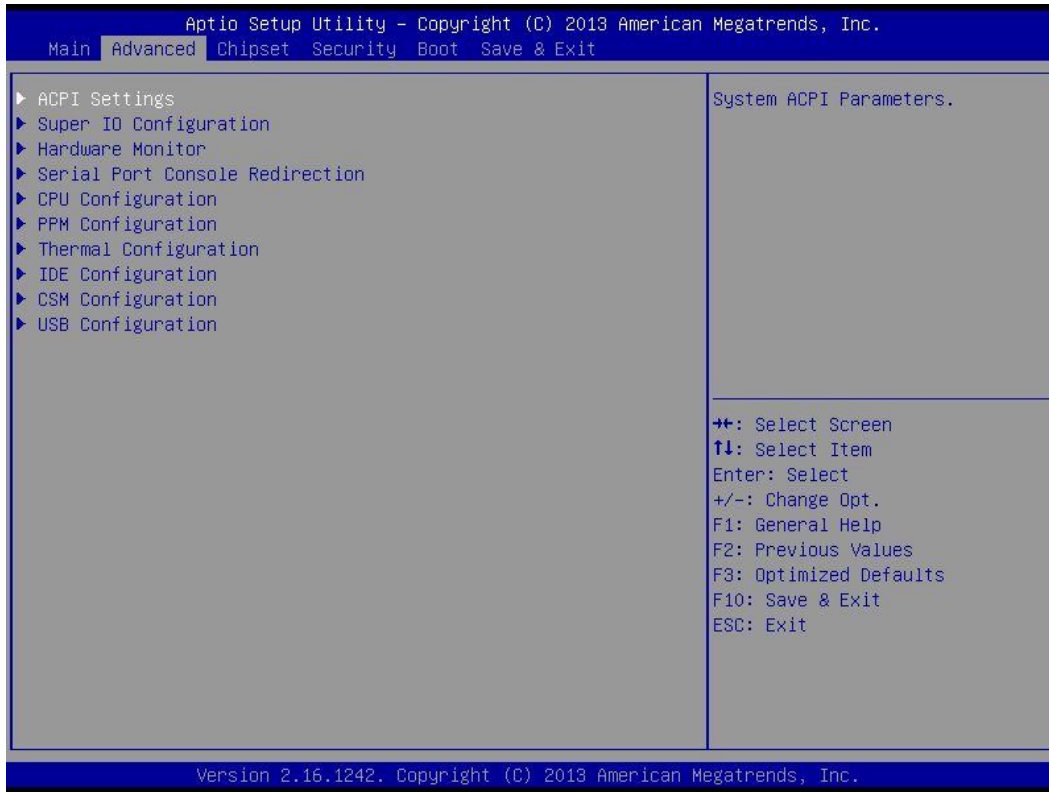

4.3.1 ACPI Settings

Enable or disable BIOS ACPI Auto Configuration.

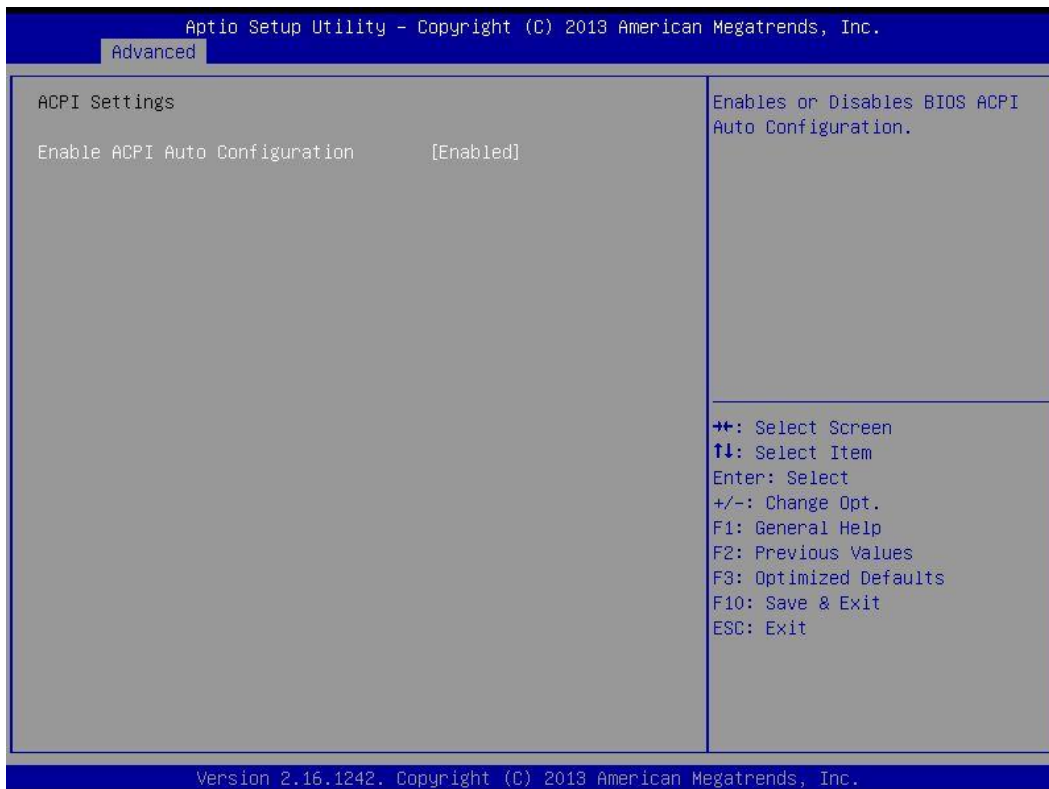

4.3.2 Super IO Configuration

You can use this screen to select options for the Super IO Configuration, and change the value of the selected option.

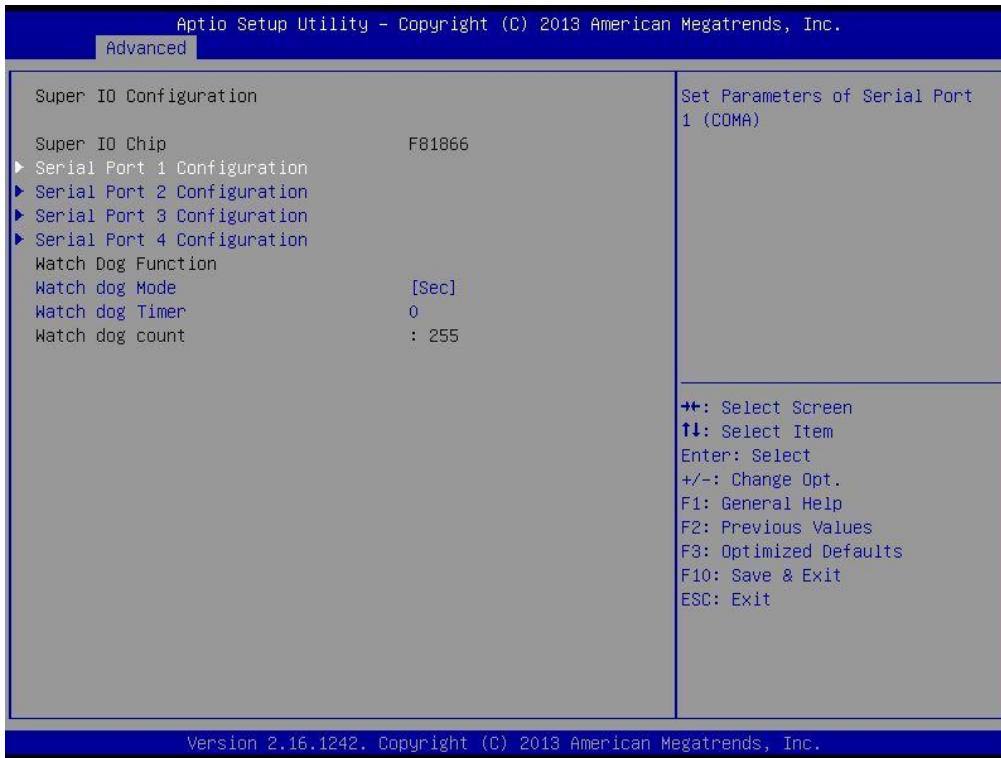

Serial Port 1 Configuration

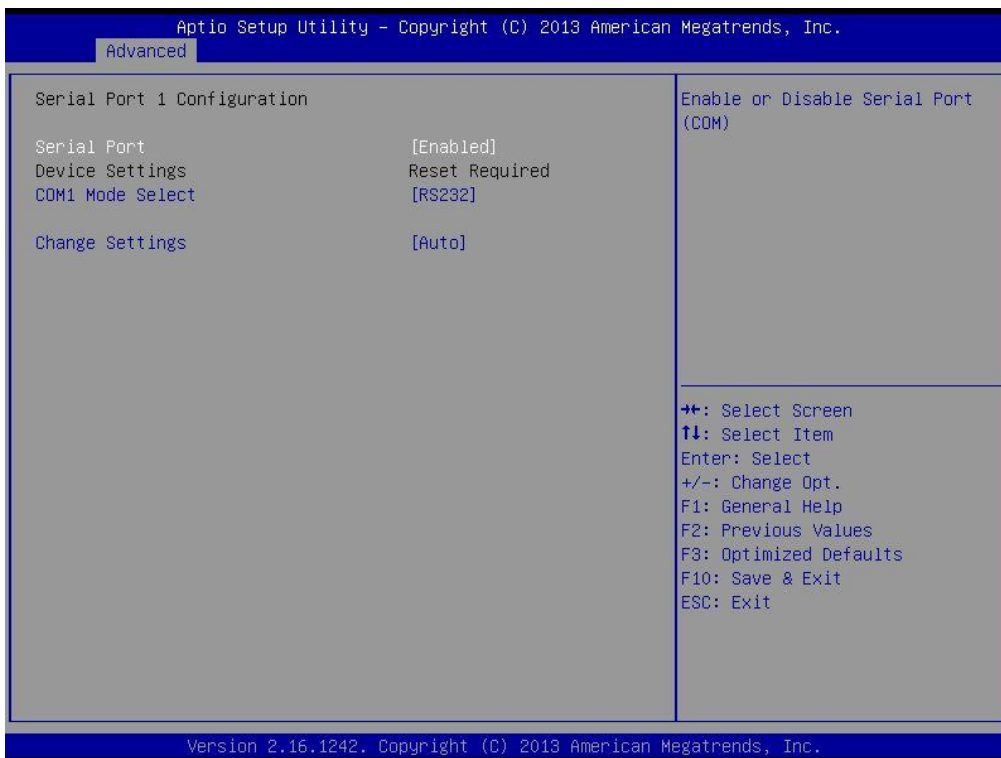

Serial Port

This item will allow users to enable or disable serial port.

COM1 Mode Select

Change the Serial interface. Select <RS232> ,<RS422> or <RS485> interface.

Change Settings

This setting is used to change the address & IRQ settings of the specified serial port.

Serial Port 2 Configuration

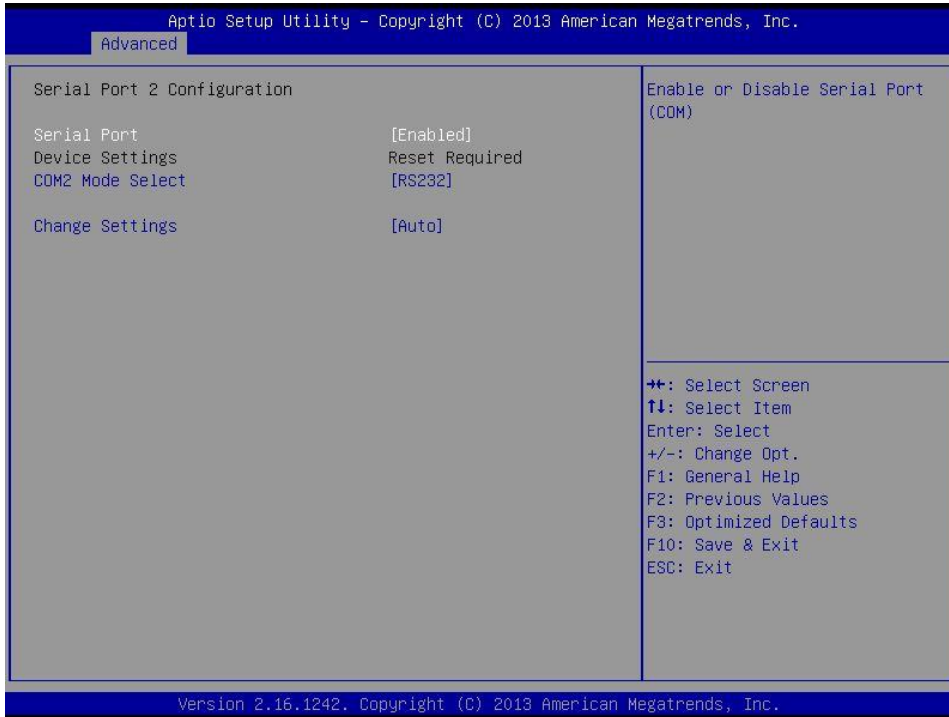

Serial Port

This item will allow users to enable or disable serial port.

COM2 Mode Select

Change the Serial interface. Select <RS232> ,<RS422> or <RS485> interface.

Change Settings

This setting is used to change the address & IRQ settings of the specified serial port.

Serial Port 3 Configuration

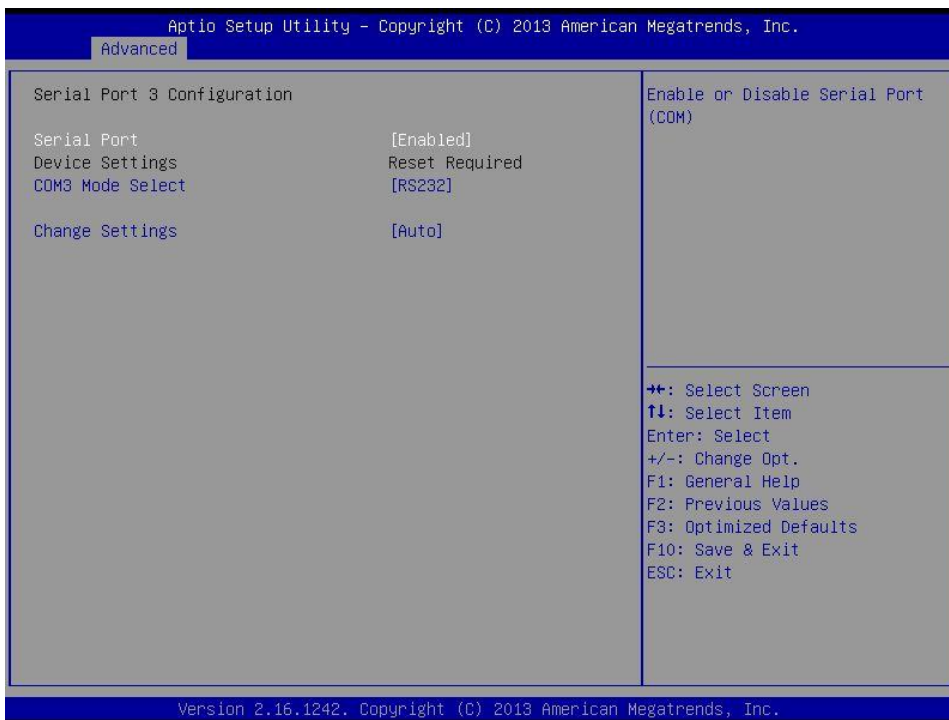

Serial Port

This item will allow users to enable or disable serial port.

COM3 Mode Select

Change the Serial interface. Select <RS232> ,<RS422> or <RS485> interface.

Change Settings

This setting is used to change the address & IRQ settings of the specified serial port.

Serial Port 4 Configuration

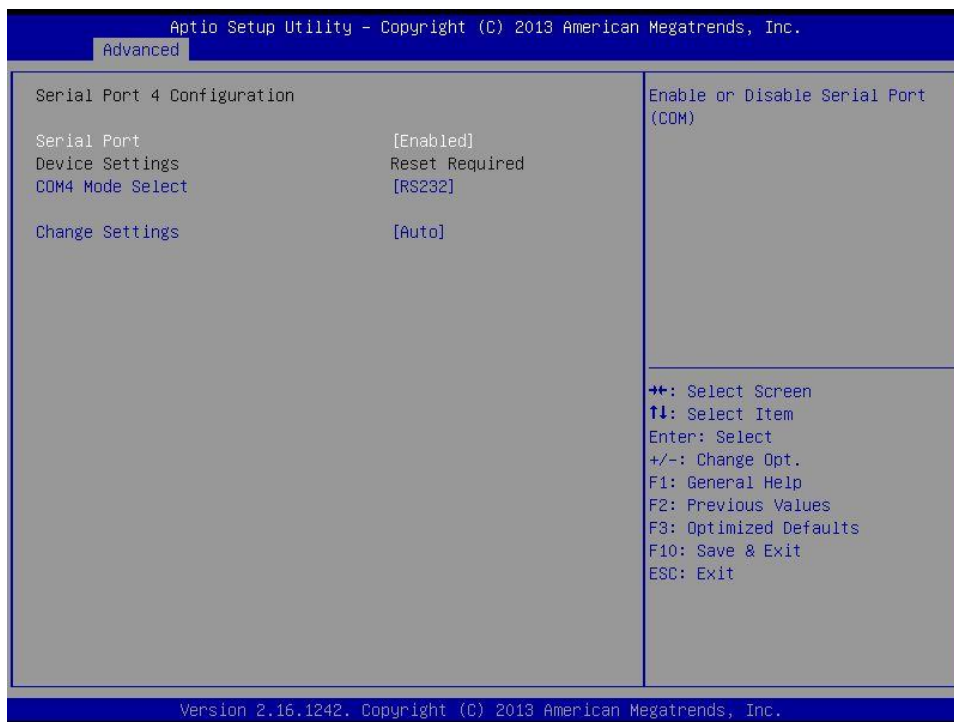

Serial Port

This item will allow users to enable or disable serial port.

COM4 Mode Select

Change the Serial interface. Select <RS232> ,<RS422> or <RS485> interface.

Change Settings

This setting is used to change the address & IRQ settings of the specified serial port.

Watch Dog Function

You can setup the system watch-dog timer, a hardware timer that generates a reset when the software that it monitors does not respond as expected each time the watch dog polls it.

Watch Dog Mode

Change the Watch dog mode. Select <Sec> or <Min> mode.

Watch Dog Timer

User can set a value in the range of 0 to 255.

4.3.3 Hardware Monitor

These items display the current status of all monitored hardware devices/ components such as voltages and temperatures.

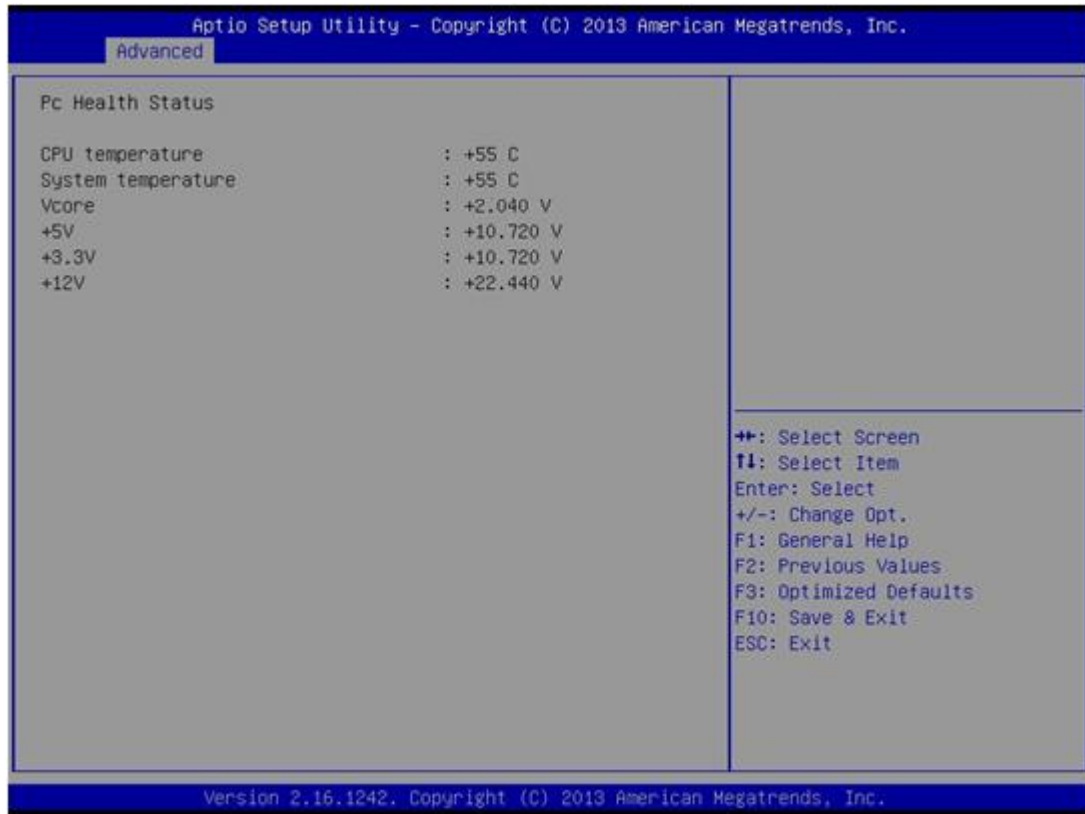

4.3.4 Serial Port Console Redirection

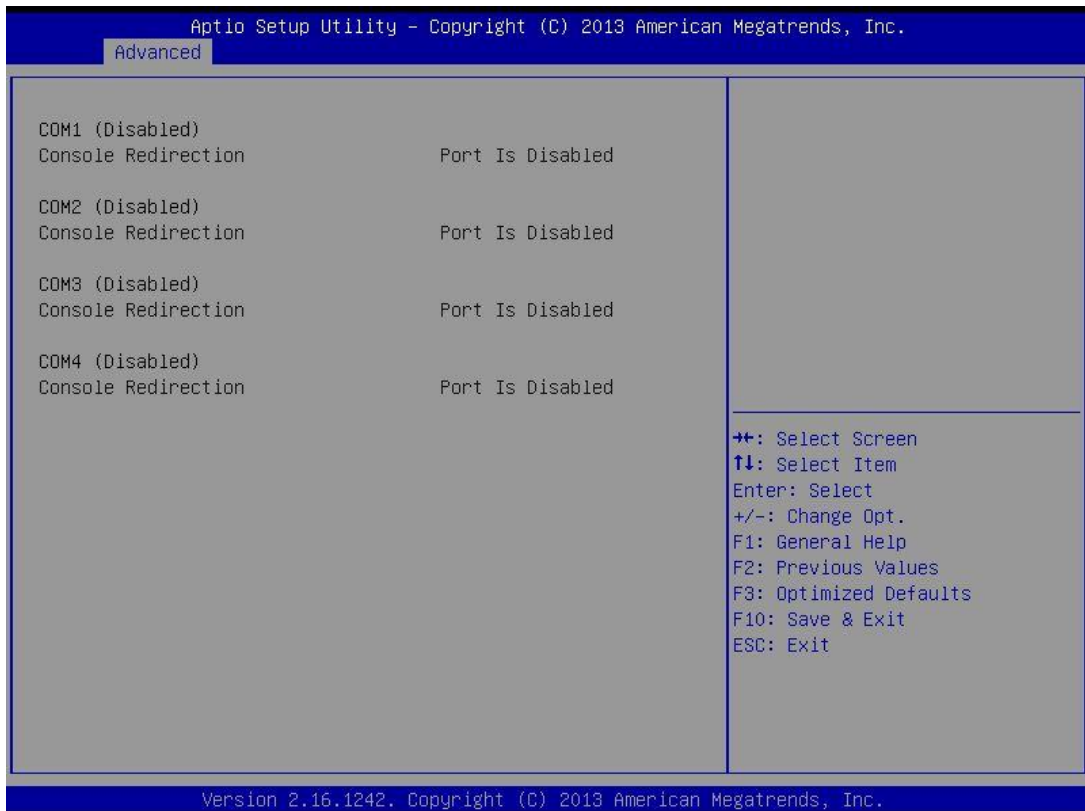

■ Console Redirection

This item allows users to enable or disable console redirection.

4.3.5 CPU Configuration

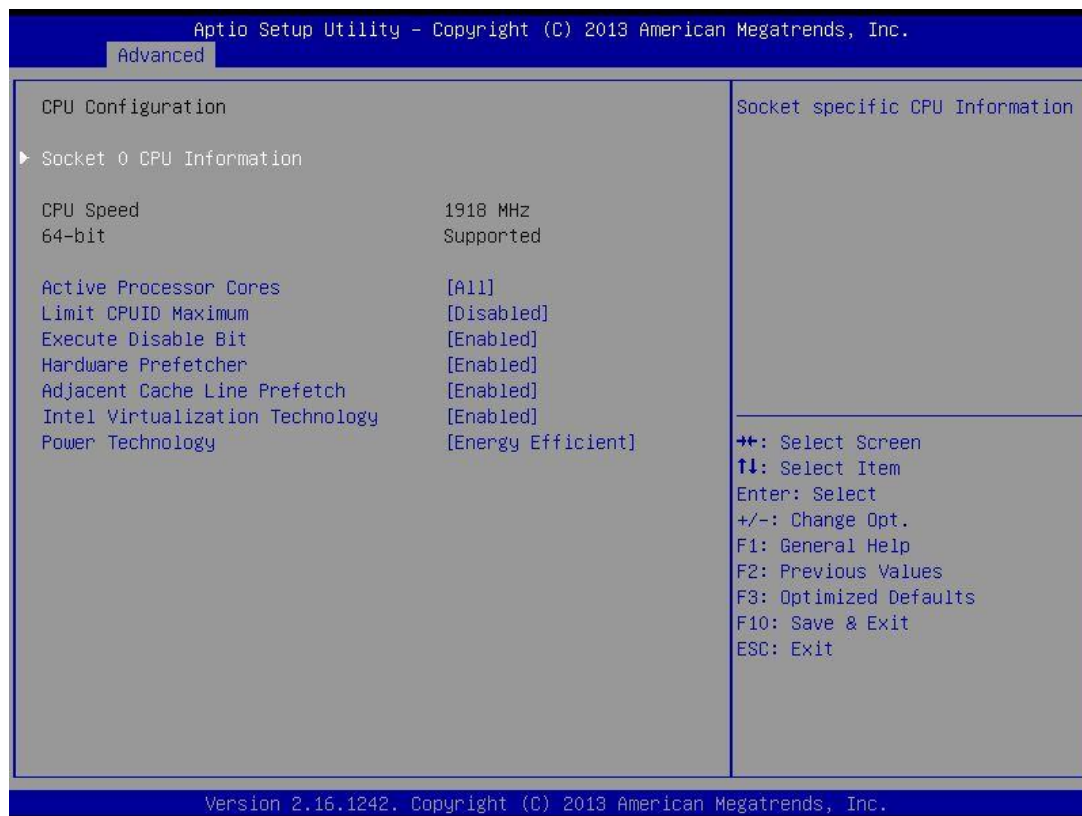

■ Socket 0 CPU Information

This section provides information on your CPU, frequency, and cache memory.

■ Active Processor Cores

Change the active processor cores. Select <All> or <1> mode.

■ Limit CPUID Maximum

Allows user to determine whether to limit CPUID maximum value. Set this item to Disabled: For Windows XP operating system.

Enabled: For legacy operating system such as Windows NT4.0. (Default: Disabled)

■ Execute Disable Bit

Enables or disables Intel Execute Disable Bit function.

■ Hardware Prefetcher

Enables or disables L2 Cache Hardware Prefetcher.

■ Adjacent Cache Line Prefetch

Enables or disables L2 prefetching of adjacent cache lines.

■ Intel Virtualization Technology

Enables or disables Intel Virtualization Technology. Virtualization enhanced by Intel Virtualization Technology will allow a platform to run multiple operating systems and applications in independent partitions. With virtualization, one computer system can function as multiple virtual systems.

■ Power Technology

Allows user to configure Intel power management features.

4.3.6 PPM Configuration

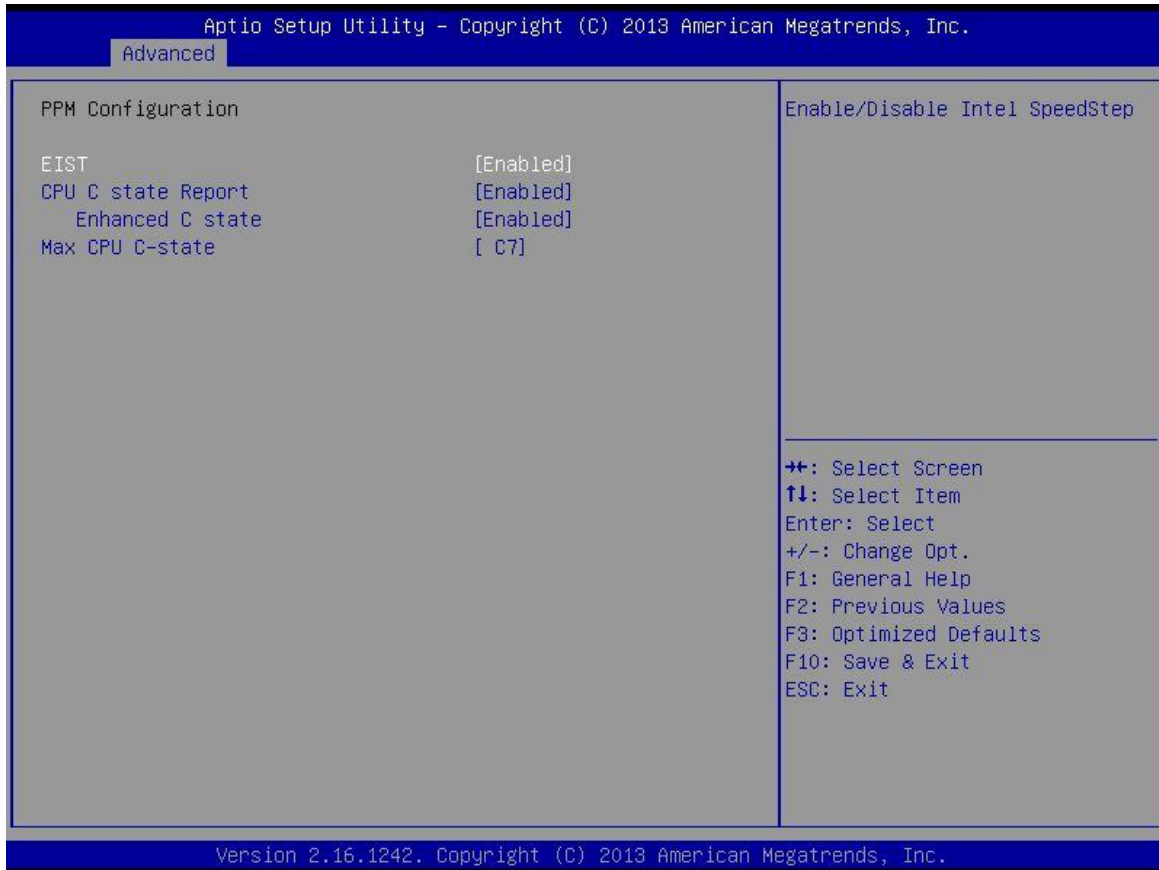

■ EIST

Enable or disable Intel SpeedStep.

■ CPU C state Report

Enables or disables support for CPU's power-saving functions.

■ Enhanced C state

Enables or disables Intel CPU Enhanced Halt (C1E) function, a CPU power-saving function in system halt state. When enabled, the CPU core frequency and voltage will be reduced during system halt state to decrease power consumption. This item is configurable only when CPU C state Report is enabled.

■ Max CPU C-state

Allows user to determine the maximum C state that the CPU will support.

4.3.7 Thermal Configuration

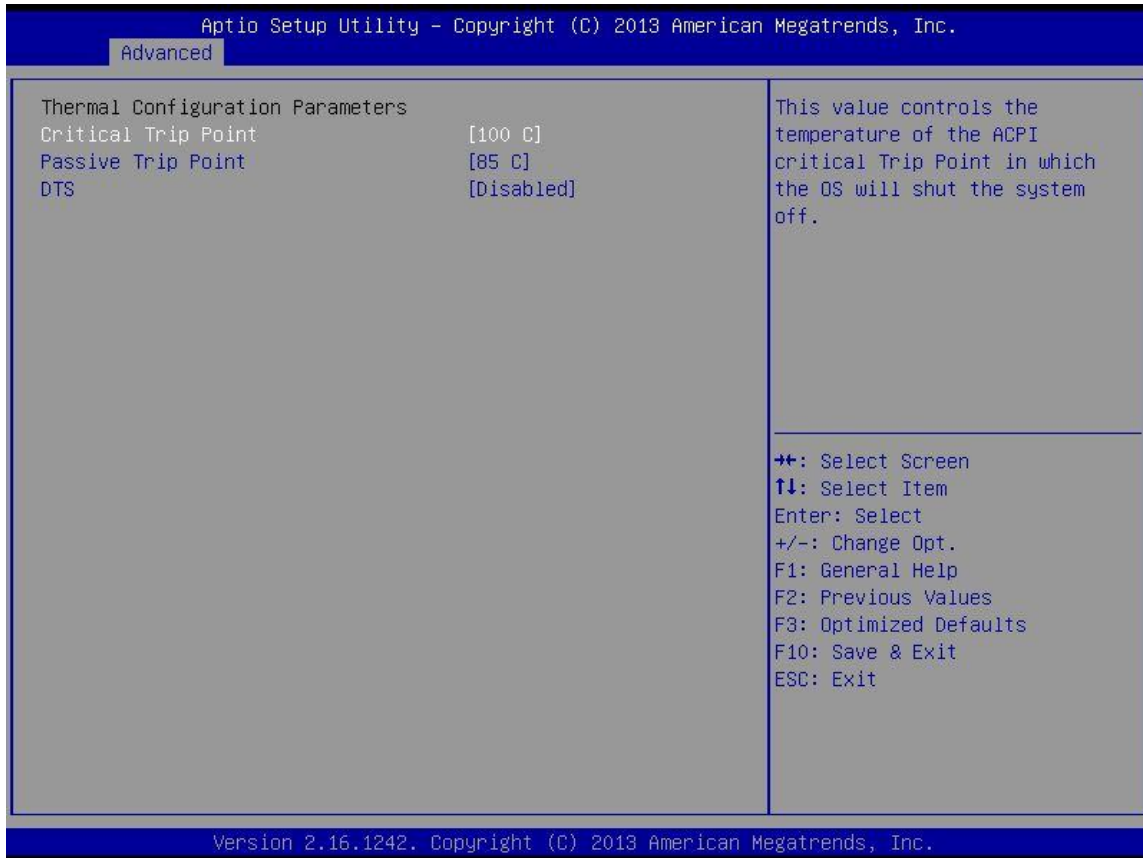

■ Critical Trip Point

Allows user to set the CPU temperature threshold. If the CPU temperature reaches this value, the operating system will shut down the system. This item is configurable only when DTS is enabled.

■ Passive Trip Point

Allows user to set the CPU temperature threshold. If the CPU temperature reaches this value, the CPU frequency will be automatically reduced. This item is configurable only when DTS is enabled.

■ DTS

Enables or disables the CPU overheating protection function. (Default: Disabled)

4.3.8 IDE Configuration

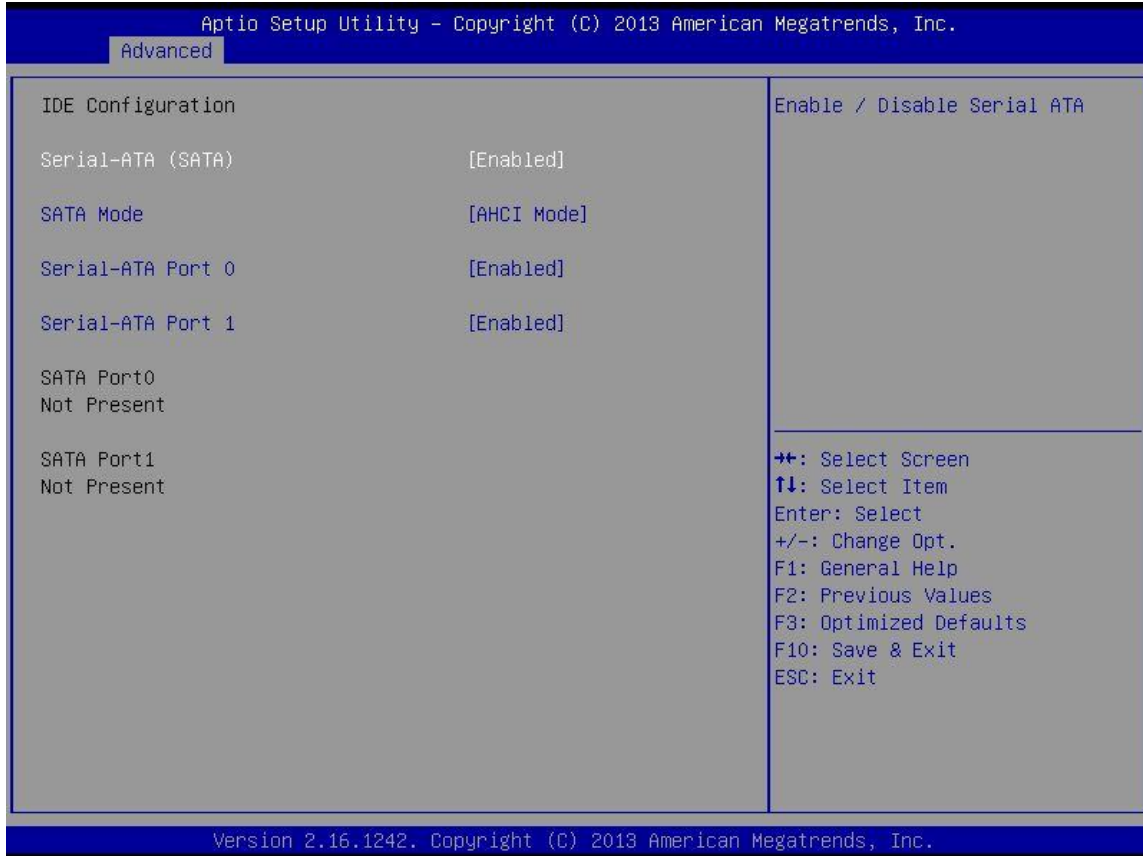

■ Serial-ATA (SATA)

This item will allow users to enable or disable Serial ATA.

■ SATA Mode

This item will allow users to select IDE or AHCI Mode.

■ Serial – ATA Port 0

This item will allow users to enable or disable Serial-ATA Port 0.

■ Serial – ATA Port 1

This item will allow users to enable or disable Serial-ATA Port 1.

4.3.9 Compatibility Support Module Configuration



■ CSM Support

Enables or disables UEFI CSM (Compatibility Support Module) to support a legacy PC boot process.

■ Boot option filter

Allows user to select which type of operating system to boot.

UEFI and Legacy: Allows booting from operating systems that support legacy option ROM or UEFI option ROM.

Legacy only: Allows booting from operating systems that only support legacy option ROM.

UEFI only: Allows booting from operating systems that only support UEFI option ROM.

This item is configurable only when CSM Support is set to Enabled.

■ Wake on LAN

This item will allow users to enable or disable wake on LAN function.

■ PXE Function

This item will allow users to enable or disable PXE function.

■ Storage

Allows user to select whether to enable the UEFI or legacy option ROM for the storage device controller.

Do not launch: Disables option ROM.

UEFI only: Enables UEFI option ROM only.

Legacy only: Enables legacy option ROM only.

■ Video

Allows user to select whether to enable the UEFI or legacy option ROM for the storage device controller.

Do not launch: Disables option ROM.

UEFI only: Enables UEFI option ROM only.

Legacy only: Enables legacy option ROM only.

4.3.10 USB Configuration

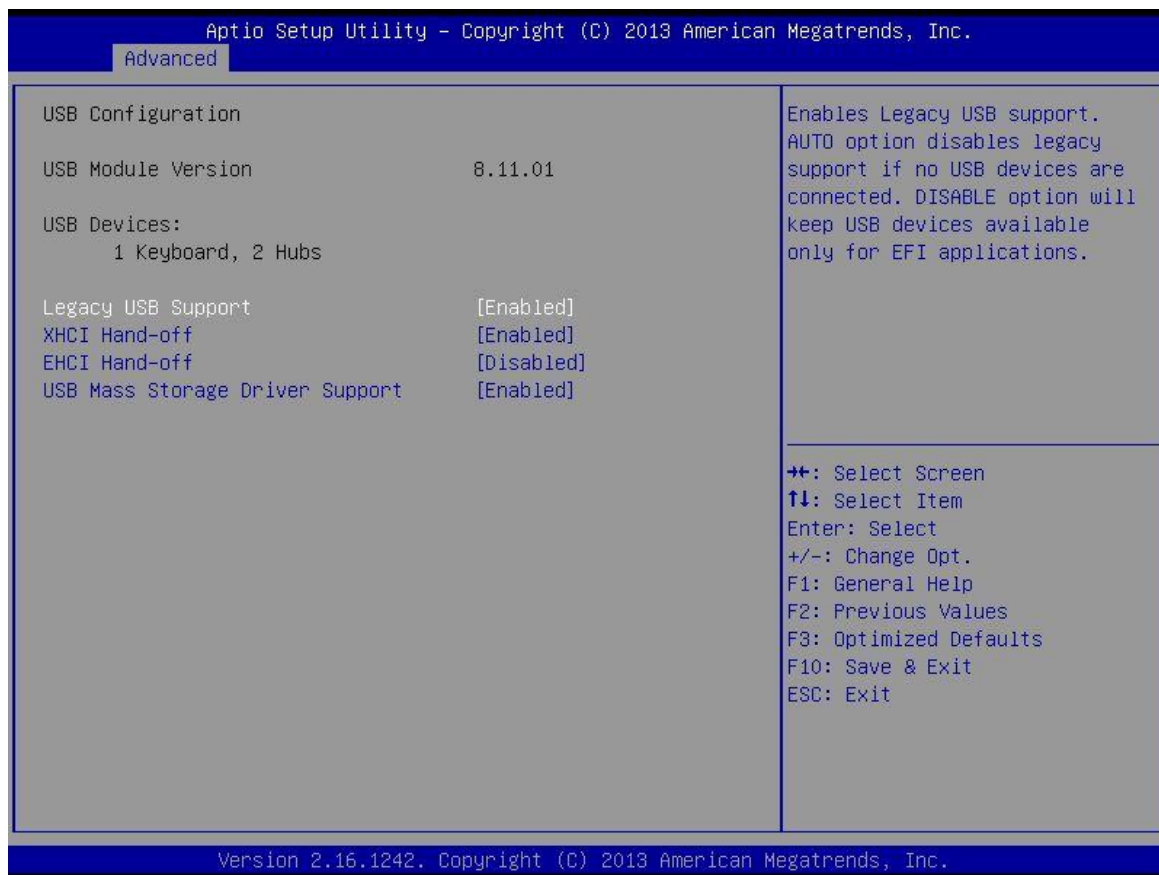

■ Legacy USB Support

Allows USB keyboard/ mouse to be used in MS-DOS.

■ XHCI Hand-off

Determines whether to enable XHCI (USB3.0) Hand-off feature for an operating system without XHCI (USB3.0) Hand-off support.

■ EHCI Hand-off

Determines whether to enable EHCI Hand-off feature for an operating system without EHCI Hand-off support.

■ USB Mass Storage Driver Support

Enables or disables support for USB storage devices.

4.4 Chipset



4.4.1 North Bridge

This section provides information on the installed memory size and memory/onboard graphics-related configuration options.

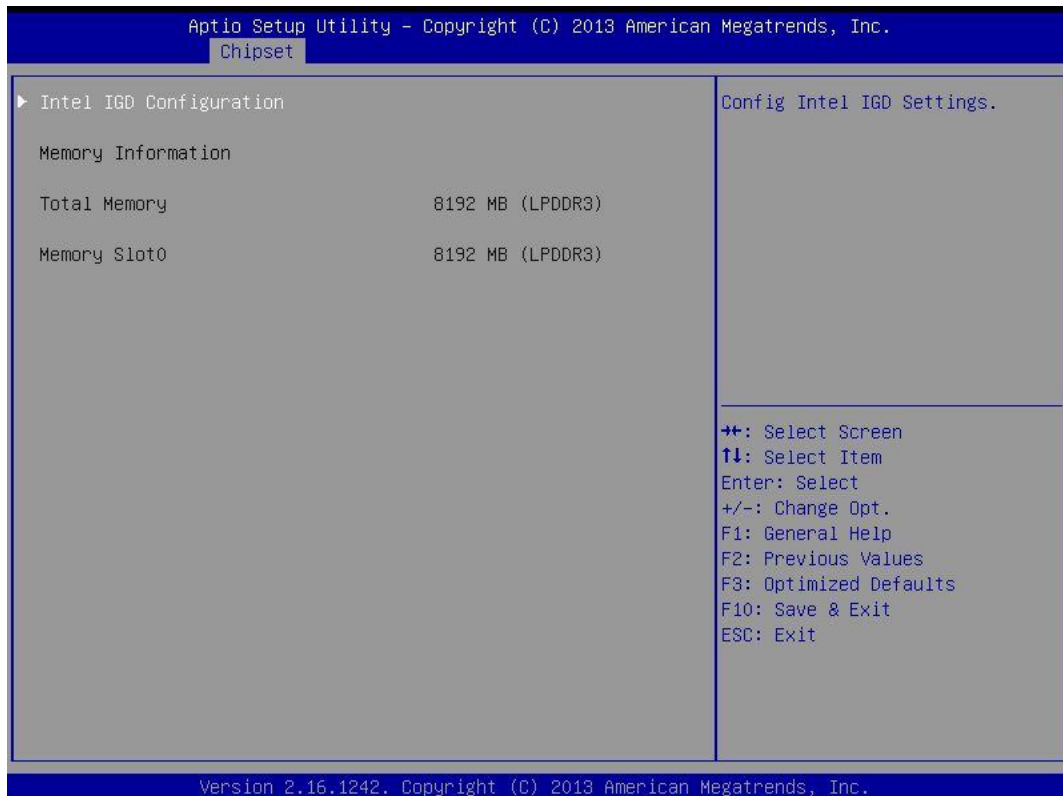

■ Intel IGD Configuration

This section provides onboard graphics-related configuration options.

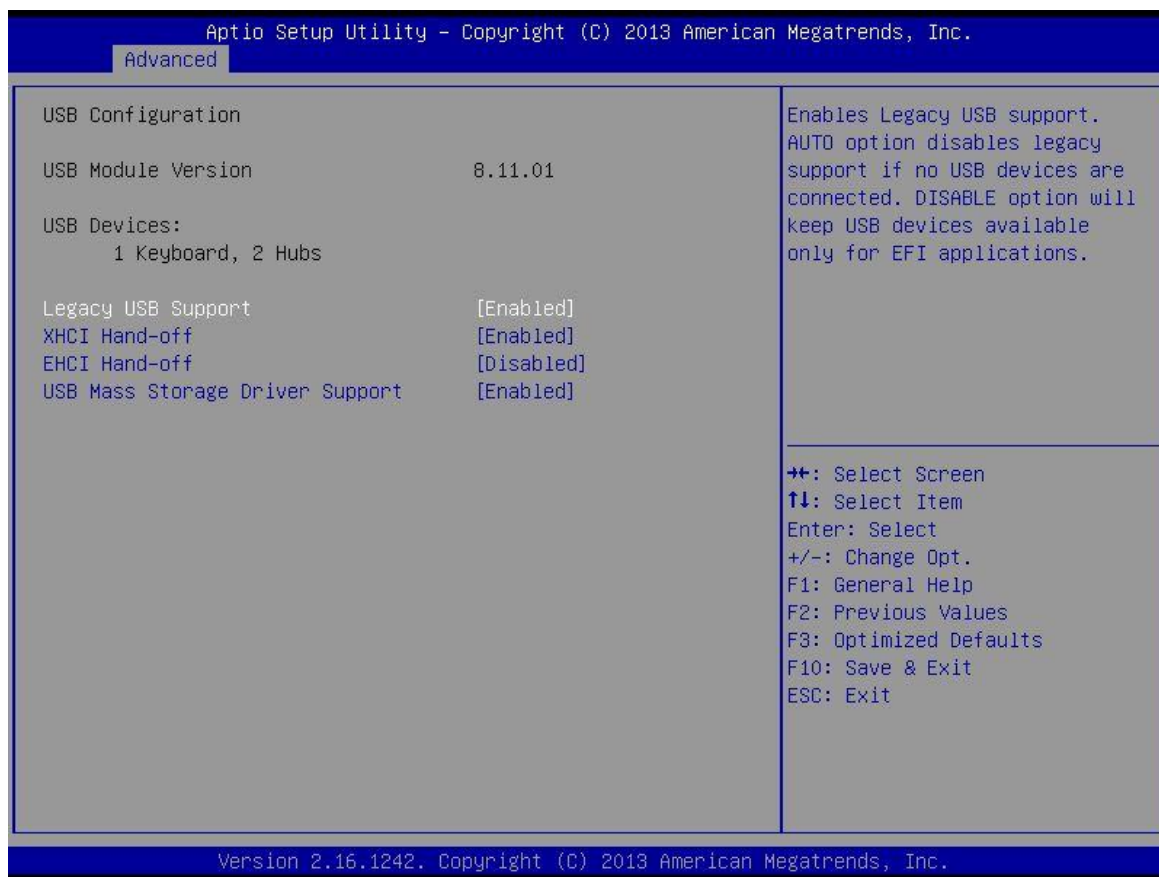

GOP Driver

This item will allow users to enable or disable GOP Driver.

Integrated Graphics Device

This item will allow users to enable or disable Integrated Graphics Device.

IGD Turbo Enable

This item will allow users to enable or disable IGD Turbo.

Primary Display

"Auto or IGFX or PEG or PCIE or SG" optimal to Primary Display.

GFX Boost

This item will allow users to enable or disable GFX Boost.

Aperture Size

Aperture size optimal between 128MB, 256MB, or 512MB.

DOP CG

This item will allow users to enable or disable DOP CG.

GTT Size

GTT size optimal between 1MB or 2MB.

IGD Thermal

This item will allow users to enable or disable IGD Thermal.

4.4.2 South Bridge

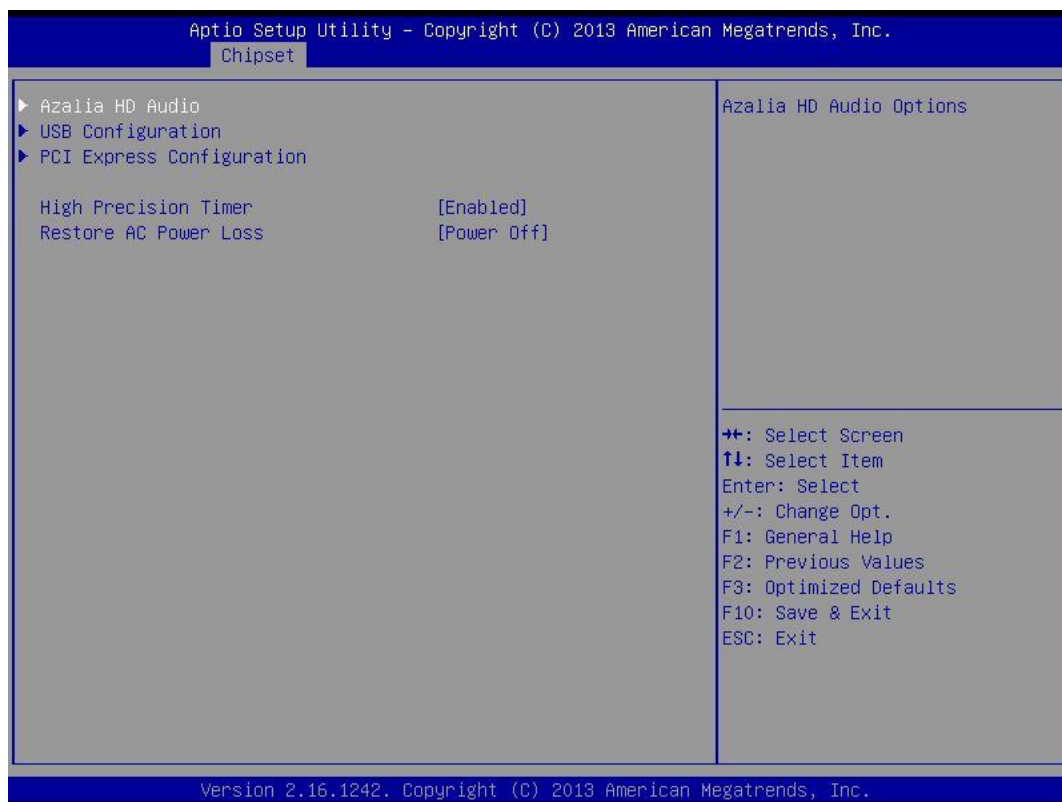

■ Azalia HD Audio

Control detection of the Azalia device.

□ Audio Controller

Enabled: Azalia will be unconditionally enabled.

Disabled: Azalia will be unconditionally disabled.

■ USB Configuration

□ XHCI Mode

This setting disables/enables the USB XHCI controller. The eXtensible Host Controller Interface (XHCI) is a computer interface specification that defines a register-level description of a Host Controller for Universal Serial Bus (USB), which is capable of interfacing to USB 1.0, 2.0, and 3.0 compatible devices. The specification is also referred to as the USB 3.0 Host Controller specification.

□ USB 2.0 (EHCI) Support

This setting disables/enables the USB EHCI controller. The Enhanced Host Controller Interface (EHCI) specification describes the register-level interface for a Host Controller for the Universal Serial Bus (USB) Revision 2.0.

□ USB RMH Mode

This item will allow users to enable or disable USB RMH Mode.

□ USB Port 0

This item will allow users to enable or disable USB Port 0.

□ USB Port 1

This item will allow users to enable or disable USB Port 1.

□ USB Port 2

This item will allow users to enable or disable USB Port 2.

□ USB Port 3

This item will allow users to enable or disable USB Port 3.

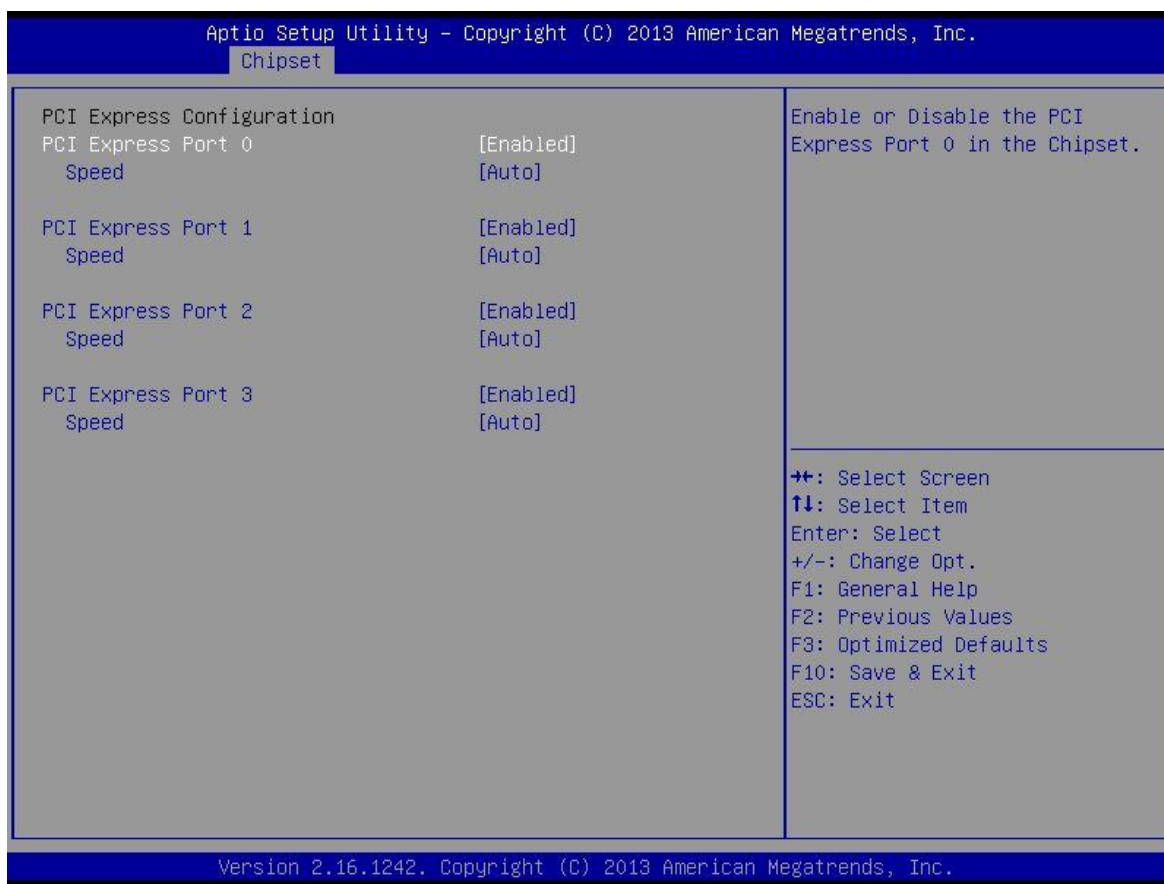

■ PCI Express Configuration

□ PCI Express Port 0

This item will allow users to enable or disable PCI Express Port 0.

□ Speed

Change the PCI Express interface speed. Select <AUTO> ,<Gen 2> or <Gen 1>

□ PCI Express Port 1

This item will allow users to enable or disable PCI Express Port 1.

□ Speed

Change the PCI Express interface speed. Select <AUTO> ,<Gen 2> or <Gen 1>

□ PCI Express Port 2

This item will allow users to enable or disable PCI Express Port 2.

□ Speed

Change the PCI Express interface speed. Select <AUTO> ,<Gen 2> or <Gen 1>

□ PCI Express Port 3

This item will allow users to enable or disable PCI Express Port 3.

□ Speed

Change the PCI Express interface speed. Select <AUTO> ,<Gen 2> or <Gen 1>

■ High Precision Timer

Enable or disable High Precision Event Timer (HPET) in the operating system.

■ Restore AC Power Loss

This setting specifies whether your system will reboot after a power failure or interrupt occurs. Available settings are:

Power Off: Leave the computer in the power off state.

Power On: Leave the computer in the power on state.

Last State: Restore the system to the previous status before power failure or interrupt occurred.

4.5 Security

This section allows you to configure and improve your system and allows you to set up some system features according to your preference.

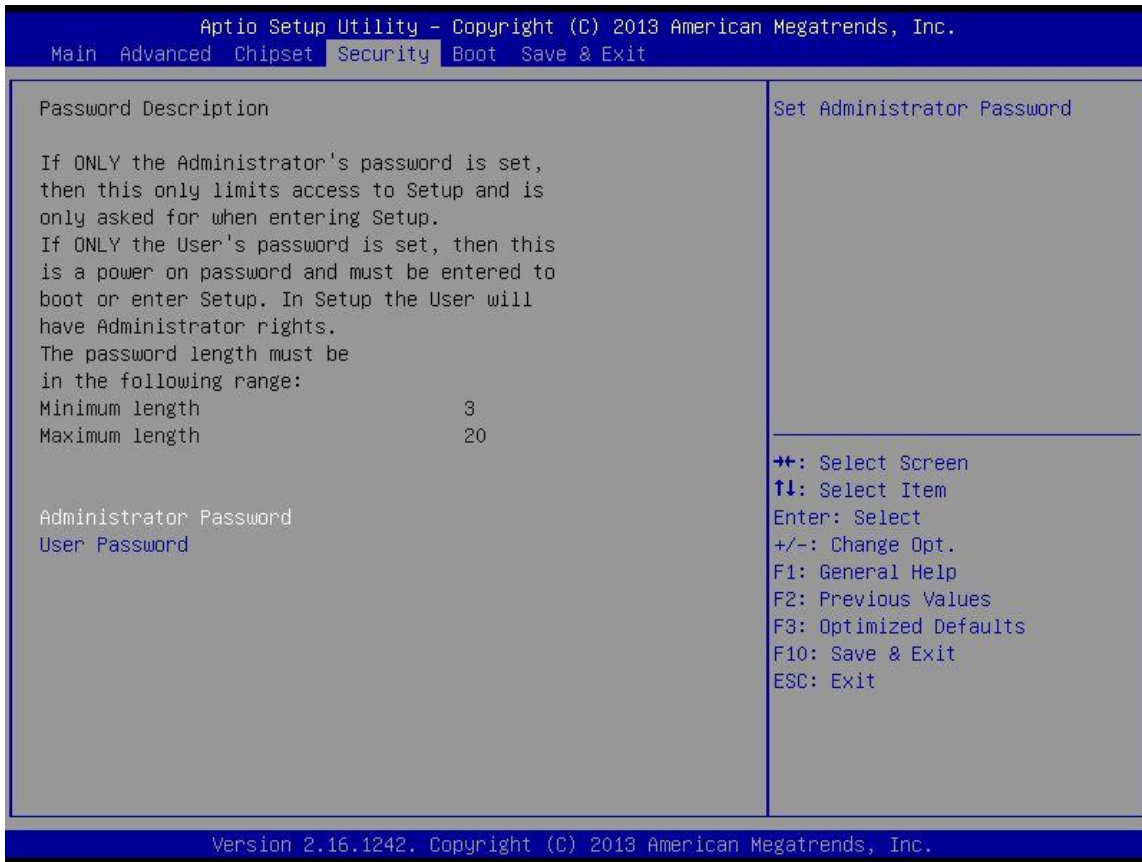

4.5.1 Administrator Password

Administrator Password controls access to the BIOS Setup utility.

4.5.2 User Password

User Password controls access to the system at boot and to the BIOS Setup utility.

4.6 Boot

This section allows you to configure the boot settings.

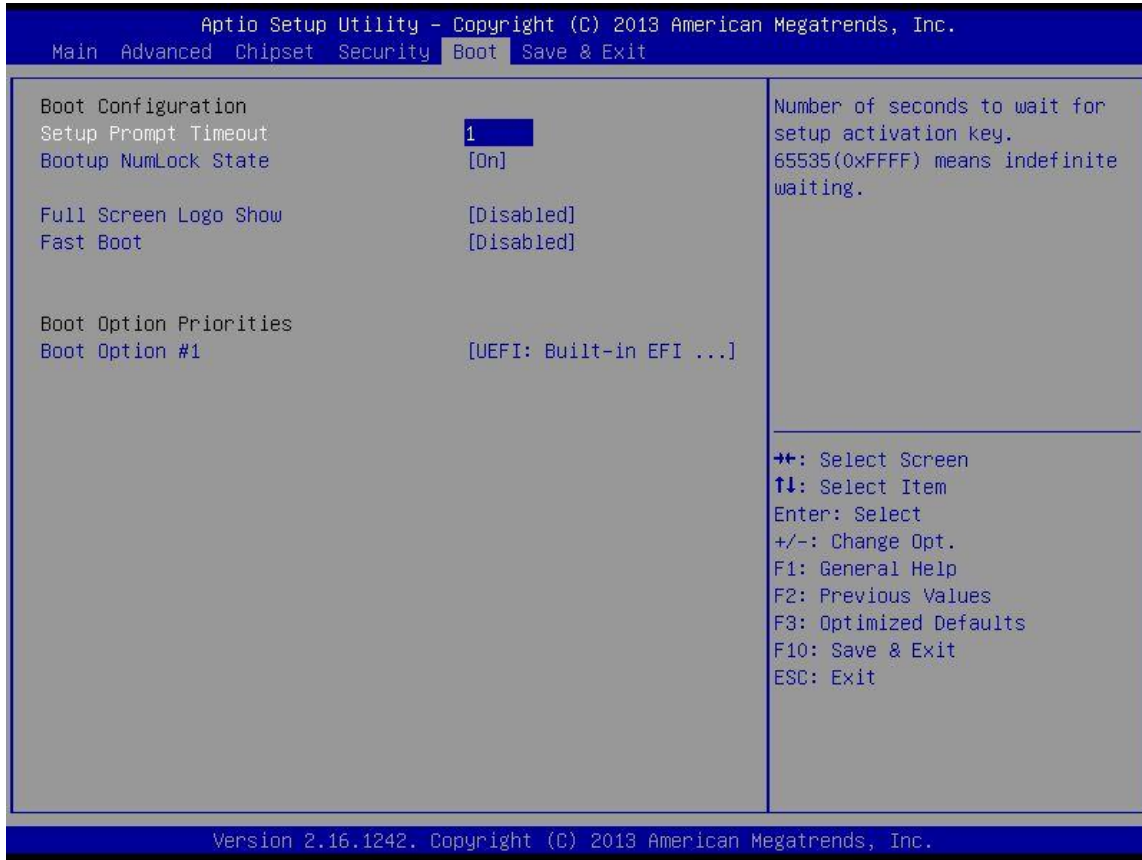

4.6.1 Setup Prompt Timeout

Use this item to set number of seconds to wait for setup activation key.

4.6.2 Bootup NumLock State

Select the Power-on state for Numlock.

4.6.3 Full Screen Logo Show

This item allows user to enable or disable full screen logo show.

4.6.4 Fast Boot

This item allows user to enable or disable Fast Boot option.

4.7 Save & Exit

This section allows you to configure the boot settings.

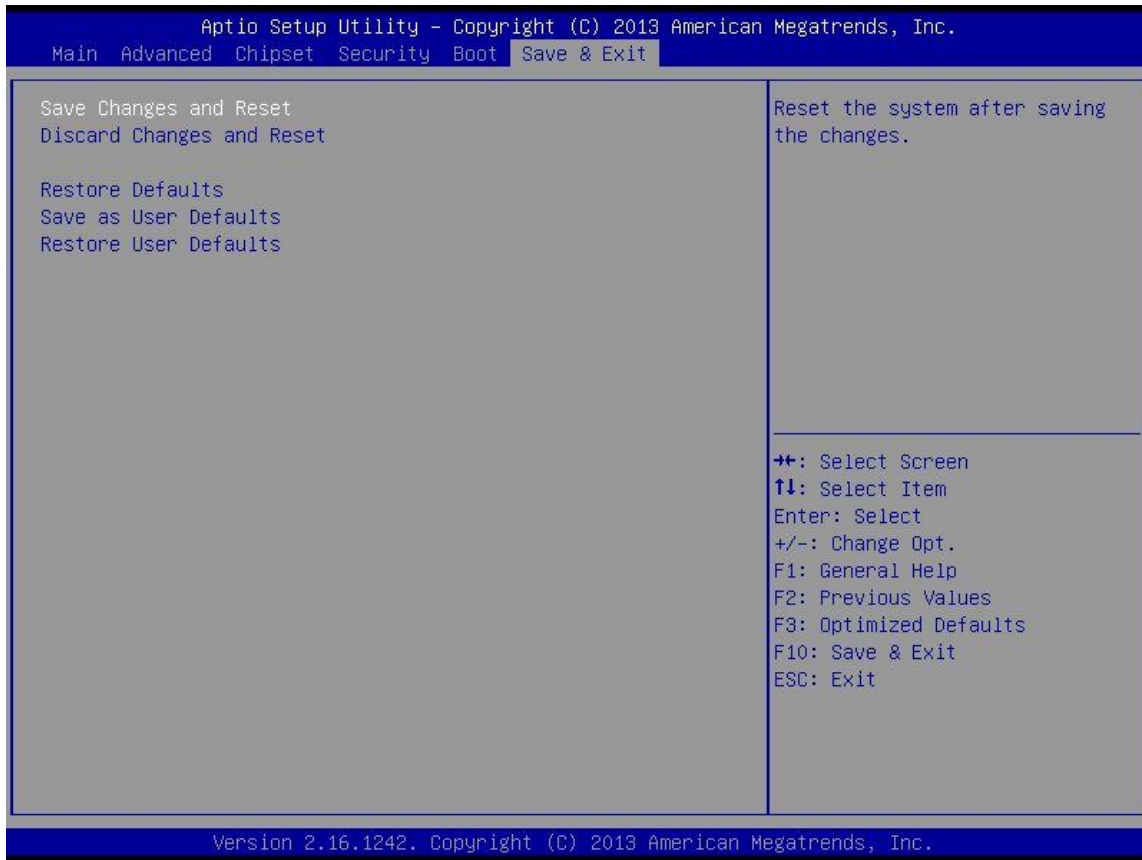

4.7.1 Save Changes and Reset

This item allows user to reset system setup after saving changes.

4.7.2 Discard Changes and Reset

This item allows user to reset system setup without saving any changes.

4.7.3 Restore Defaults

This item allows user to restore/ load default values for all the options.

4.7.4 Save as User Defaults

This item allows user to save the changes done so far as user defaults.

4.7.5 Restore User Defaults

This item allows user to restore the user defaults to all the options.



www.cincoze.com

© 2014 Cincoze Co., Ltd. All rights reserved.

The Cincoze logo is a registered trademark of Cincoze Co., Ltd.

All other logos appearing in this catalog are the intellectual property of the respective company, product, or organization associated with the logo.

All product specifications and information are subject to change without notice.