



VDX-6354RD / VDX-6354RD-PLUS

DM&P Vortex86DX 800MHz

PC/104 CPU Module

with 4S/2USB/VGA/LCD/AUDIO/ LAN/GPIO/PWMx16

256MB DDR2 Onboard

User's Manual

(Revision 1.2A)

● Copyright

The information in this manual is subject to change without notice for continuous improvement in the product. All rights are reserved. The manufacturer assumes no responsibility for any inaccuracies that may be contained in this document and makes no commitment to update or to keep current information contained in this manual.

No part of this manual may be reproduced, copied, translated or transmitted, in whole or in part, in any form or by any means without the prior written permission of the ICOP Technology Inc.

©Copyright 2008 ICOP Technology Inc.

Manual No. IUM6354D000-01 Ver.1.0A ● December, 2010

Manual No. IUM6354RD000-01 Ver.1.1A ● October, 2014

Manual No. IUM6354RD000-01 Ver.1.2A ● January, 2015

● Trademarks Acknowledgment

Vortex86DX™ is the registered trademark of ICOP Technology Inc.

Other brand names or product names appearing in this document are the properties and registered trademarks of their respective owners. All names mentioned herewith are served for identification purpose only.

Table of Contents

| | |
|--|-----|
| Table of Contents | iii |
| Chapter 1 Introduction..... | 1 |
| 1.1 Packing List..... | 1 |
| 1.2 Product Description | 2 |
| 1.3 Specifications | 3 |
| 1.4 Board Dimension..... | 5 |
| Chapter 2 Installation..... | 6 |
| 2.1 Board Outline | 6 |
| 2.2 Connectors & Jumpers Location | 7 |
| 2.3 Connectors & Jumpers Summary..... | 9 |
| 2.4 Pin Assignments & Jumper Settings..... | 10 |
| 2.5 System Mapping..... | 21 |
| 2.6 Watchdog Timer | 24 |
| 2.7 GPIO | 25 |
| 2.8 SPI flash..... | 26 |
| 2.9 PWM | 27 |
| 3.0 IDE to SD | 28 |
| Chapter 3 Driver Installation..... | 29 |
| Appendix | 30 |
| A. TFT Flat Panel Data Output | 30 |
| B. TFT Flat Panel Support List..... | 31 |
| C. LVDS Flat Panel Support List..... | 33 |
| D. Flat Panel Wiring and Lighting | 34 |
| E. TCP/IP library for DOS real mode | 35 |
| F. BIOS Default Setting..... | 36 |
| Warranty..... | 37 |

This page is blank

Chapter 1

Introduction

1.1 Packing List

| Product Name | Package |
|--|--|
| VDX-6354RD & VDX-6354RD-PLUS | <ul style="list-style-type: none">● Embedded Vortex86DX CPU All-in-One Board● Manual & Drivers CD x 1● RS232 cable x 4● PRINTER cable x1● IDE cable x 1● USB cable x 1 (USB port x 2)● VGA cable x 1● LAN cable x 1● GPIO cable x 1● AUDIO Line x2● PS/2 Mouse cable x 1● PS/2 Keyboard cable x 1● Screw Kit x 1 |

1.2 Product Description

The VDX-6354RD family of low-power x86 embedded controller is designed to meet PC/104 specification, and integrated with the following features.

- 800 MHz Vortex86DX SoC
- VGA, TFT/ LVDS LCD support up to 1280x1024 resolution
- 256 / 512MB DDR2 system memory
- Enhanced IDE (UltraDMA-100/66/33)
- 10/100Mbps Ethernet
- 2 USB 2.0 (host)
- Up to 4 serial ports
- Parallel port
- 16-bit GPIOs
- Audio
- Onboard 4MB SPI Flash
- PC/104-Plus expansion bus
- Meet PC/104 stacking spec.
- 2 watchdog timer
- PWM 16~24 channels
- JTAG interface
- AMI BIOS
- Single voltage +5V DC
- Support extended operating temperature range of -20°C to +70°C

The VDX-6354RD PC/104 family of embedded controller is designed with backward compatibility in mind, to provide migration path for projects facing end-of-life challenges with their existing x86 based PC/104 controller. The VDX-6354RD family of controller is designed as a plug in replacement, with backward compatibility to support legacy software to help extend existing product life cycle without heavy re-engineering.

VDX-6354RD is suitable for broad range of data-acquisition, Industrial automation, Process control, Automotive controller, AVL, Intelligent Vehicle management devic, Medical device, Human machine interface, Robotics, machinery control And more...application that required small footprint, low-power and low-cost hardware with open industry standard such as PC/104.

1.3 Specifications

| Features | VDX-6354RD |
|----------------|---|
| CPU | DM&P SoC CPU Vortex86DX- 800MHz Real Time Clock with Lithium Battery Backup |
| Cache | L1:16K I-Cache, 16K D-Cache L2:128KB Cache |
| BIOS | AMI BIOS |
| Bus Interface | PC/104 Standard Compliant (Optional: PCI-104) |
| System Memory | 256 / 512MB DDR2 Onboard |
| Watchdog Timer | Software programmable from 30.5 us to 512 seconds x2 sets(Watchdog 1 fully compatible with M6117D) |
| VGA | XGI Volari Z9s Chipset VGA and TFT Flat Panel Interface Support LVDS Flat Panel Interface Support (Optional) Onboard 32MB VGA Memory Support resolution up to 1280 x 1024,16MB colors |
| LAN | Integrated 10/100M Ethernet |
| AUDIO | CM119 USB Audio controller |
| I/O Interface | <ul style="list-style-type: none"> ● Enhanced IDE port (UltraDMA-100/66/33) x1 ● RS-232 port x3 ● RS-232/422/485 port x1 (RS485: Auto Direction) ● Parallel port x1 ● USB port x2 (USB 2.0 version) ● 16-bit GPIO port x1 ● 10/100Mbps Ethernet port x1 |
| Connectors | <ul style="list-style-type: none"> ● 2.00 mm Ø 44-pin box header for IDE x1 ● 2.00 mm Ø 44-pin box header for LCD x 1 ● 2.00 mm Ø 10-pin box header for VGA x1 ● 2.00 mm Ø 10-pin box header for USB x1 ● 2.00 mm Ø 26-pin box header for Printer x1 ● 2.00 mm Ø 20-pin box header for 16-bit GPIO x1 ● 2.00 mm Ø 10-pin box header for RS-232 x4 ● 2.00 mm Ø 8-pin header for Ethernet x 1 ● 2.54 mm Ø 5-pin box header for Keyboard x1 ● 2.54 mm Ø 5-pin header for Mouse x1 ● 2.54 mm Ø 4-pin header for DC-in x1 ● 2.54 mm Ø 3-pin header for RS-485 x1 ● 2.54 mm Ø 2-pin header for Reset x1 ● 2.54 mm Ø 7-pin header for Redundancy x1(Opt) ● 2.54 mm Ø 2-pin header for SYS-Fail-SW- x1(Opt) ● 1.25 mm Ø 6-pin Wafer for JTAG x1 ● 1.25 mm Ø 4-pin Wafer for Line-out/MIC-in x2 |

| | |
|-----------------------|--|
| Flash Disk Support | <ul style="list-style-type: none"> ● Onboard 4MB SPI Flash Disk (Driver: A) ● 44-pin IDE Flash Disk(EmbedDisk 16MB or above) ● 44-pin IDE to Micro SD (Optional) |
| PWM | 16~24 channels |
| Power Requirement | Single Voltage +5V @740mA |
| Dimension | 90 X 96mm (3.54 x 3.77 inches) |
| Weight | 90g |
| Operating Temperature | -20°C ~ +70°C -40°C ~ +85°C (Optional) |

1.4 Board Dimension

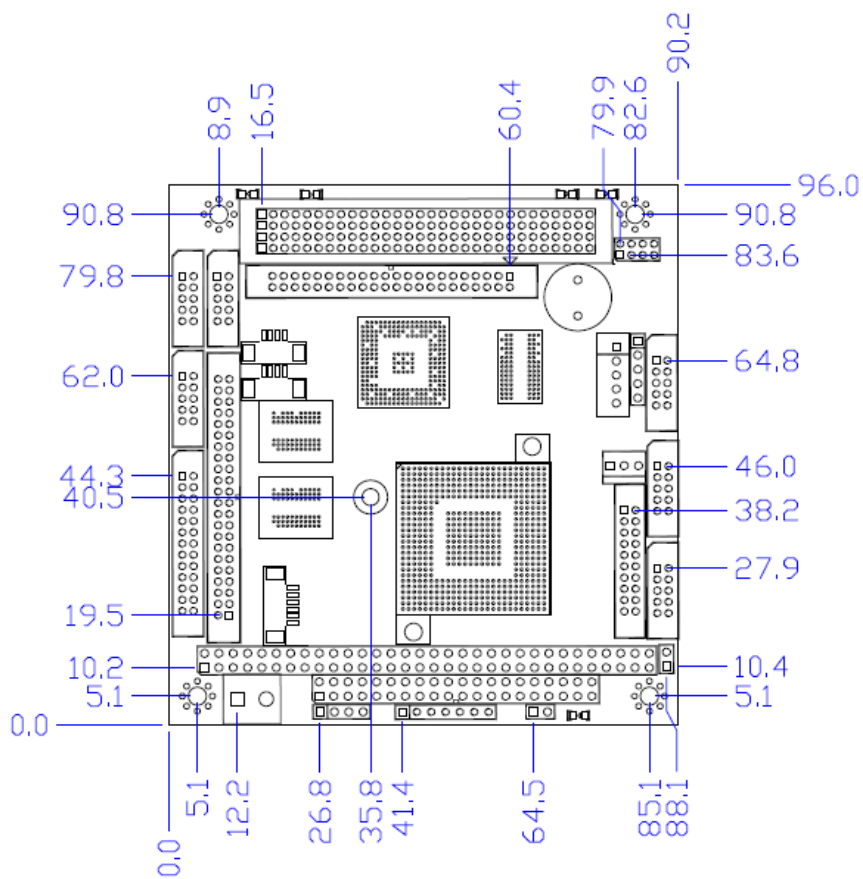

Chapter 2

Installation

2.1 Board Outline

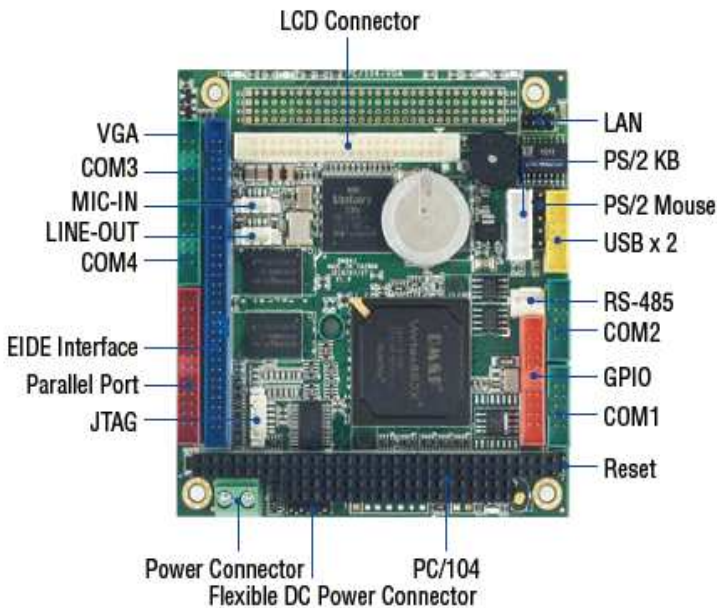

Note:

1. COM2 RS232/422/485 is selected in BIOS setting
2. PCI-104 connector is optional
3. V/I/O default voltage of PCI-104 connector is +5V
4. VDX-6354RD-512 is optional
5. Redundancy Signal and System-Fail-SW are optional

2.2 Connectors & Jumpers Location

Connectors

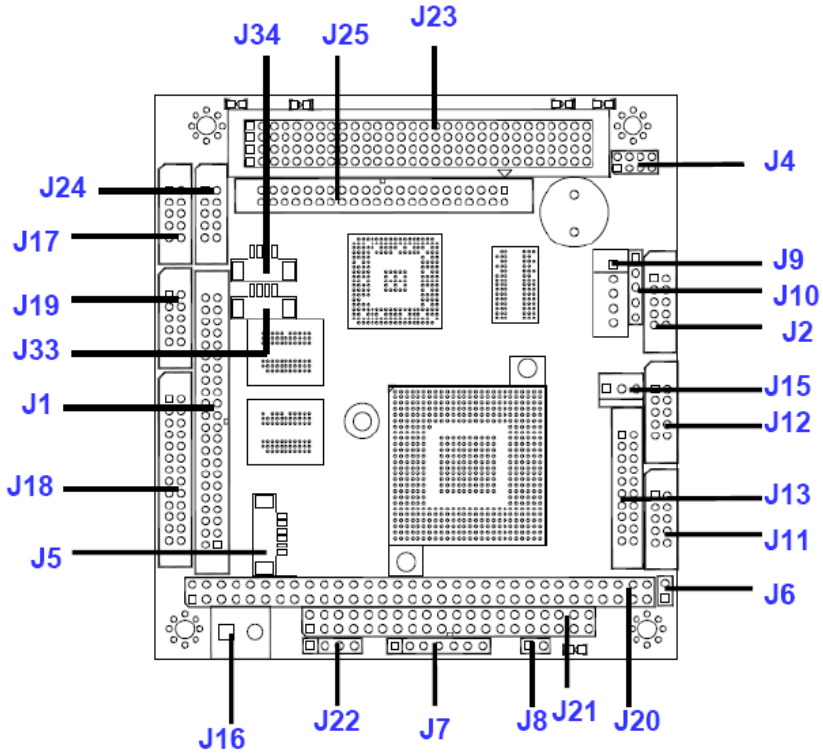

Jumpers & LEDs

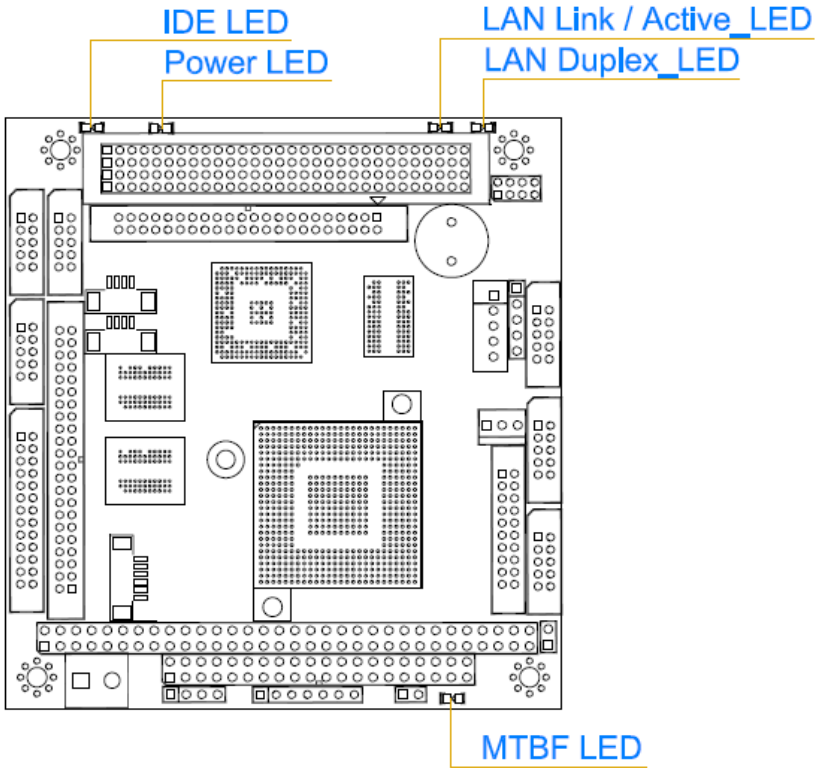

2.3 Connectors & Jumpers Summary

Summary Table

| Nbr | Description | Type of Connections | Pin nbrs. |
|----------|--|-------------------------|-----------|
| J1 | IDE | Box Header, 2,0Ø ,22x2 | 44-pin |
| J2 | USB | Box Header,2,0Ø , 5x2 | 10-pin |
| J4 | LAN | Pin Header, 2,0Ø , 4x2 | 8-pin |
| J5 | JTAG | Wafer, 1,25Ø , 6x1 | 6-pin |
| J6 | Reset | Pin Header, 2,54Ø,1x2 | 2-pin |
| J7 | Redundancy (Optional) | Pin Header, 2,54Ø, 7x1 | 7-pin |
| J8 | System –Fail-Switch (Optional) | Pin Header, 2,54Ø , 2x1 | 2-pin |
| J9 | PS/2 Keyboard | Box Header, 2,54Ø,1x5 | 5-pin |
| J10 | PS/2 Mouse | Pin Header, 2,54Ø,1x5 | 5-pin |
| J11 | COM1(RS232 or TTL/GPIO) | Box Header, 2,0Ø 5x2 | 10-pin |
| J12 | COM2(RS232/422/485 or TTL) | Box Header, 2,0Ø 5x2 | 10-pin |
| J13 | GPIO (Port 0/1 or PWMx16) | Box Header, 2,0Ø ,10x2 | 20-pin |
| J15 | RS-485 (Auto direction) | Molex Header,2,54Ø, 3x1 | 3-pin |
| J16 | Power Connector | Terminal Block 5.0Ø,2x1 | 2-pin |
| J17 | COM3(RS232 or TTL) | Box Header, 2,0Ø 5x2 | 10-pin |
| J18 | PRINT | Box Header, 2,0Ø , 13x2 | 26-pin |
| J19 | COM4(RS232 or TTL) | Box Header, 2,0Ø 5x2 | 10-pin |
| J20 | PC104 Connector – 64 pin | Box Header, 2,54Ø 32x2 | 64-pin |
| J21 | PC104 Connector – 40 pin | Box Header, 2,54Ø 20x2 | 40-pin |
| J22 | 4P Power Source (Interconnect to PC/104 – J20) | Pin Header, 2,54Ø , 4x1 | 4-pin |
| J23 | PC/104 + (Optional) | Box Header, 2,0Ø , 30x4 | 120-pin |
| J24 | VGA | Pin Header, 2,0Ø ,5x2 | 10-pin |
| J25 | LCD Connector | Box Header,2,0Ø ,22x2 | 44-pin |
| J33 | LINE-OUT | Wafer, 1,25Ø , 4x1 | 4-pin |
| J34 | MIC-IN | Wafer, 1,25Ø , 4x1 | 4-pin |
| PWR-LED | Power Active LED (Red) | LED-SMD | |
| IDE-LED | IDE Active LED (Green) | LED-SMD | |
| MTBF-LED | MTBF-Out (Orange) | LED-SMD | |
| LED 3 | LAN Link/Active LED (Green) | LED-SMD | |
| LED 4 | LAN Duplex LED (Yellow) | LED-SMD | |
| SP1 | BUZZER | | |

2.4 Pin Assignments & Jumper Settings

J1: IDE (44 Pins)

| Pin # | Signal Name | Pin # | Signal Name |
|-------|-------------|-------|-------------|
| 1 | IDERST | 2 | GND |
| 3 | IDED7 | 4 | IDED8 |
| 5 | IDED6 | 6 | IDED9 |
| 7 | IDED5 | 8 | IDED10 |
| 9 | IDED4 | 10 | IDED11 |
| 11 | IDED3 | 12 | IDED12 |
| 13 | IDED2 | 14 | IDED13 |
| 15 | IDED1 | 16 | IDED14 |
| 17 | IDED0 | 18 | IDED15 |
| 19 | GND | 20 | NC |
| 21 | IDEREQ | 22 | GND |
| 23 | IDEIOW | 24 | GND |
| 25 | IDEIOR | 26 | GND |
| 27 | ICHRDY | 28 | GND |
| 29 | IDEACK | 30 | GND |
| 31 | IDEINT | 32 | NC |
| 33 | IDESA1 | 34 | IDECBLID |
| 35 | IDESA0 | 36 | IDESA2 |
| 37 | IDECS-0 | 38 | IDECS1 |
| 39 | IDELED | 40 | GND |
| 41 | VCC | 42 | VCC |
| 43 | GND | 44 | NC |

J2: USB

| Pin # | Signal Name | Pin # | Signal Name |
|-------|-------------|-------|-------------|
| 1 | VCC | 2 | VCC |
| 3 | LUSBD3- | 4 | LUSBD2- |
| 5 | LUSBD3+ | 6 | LUSBD2+ |
| 7 | GND | 8 | GND |
| 9 | GGND | 10 | GGND |

J4: LAN

| Pin # | Signal Name | Pin # | Signal Name |
|-------|-------------|-------|-------------|
| 1 | ATX+ | 2 | ATX- |
| 3 | ARX+ | 4 | LED0 |
| 5 | LED0+ | 6 | ARX- |
| 7 | LED1+ | 8 | LED1 |

J5: JTAG

| Pin # | Signal Name | Pin # | Signal Name |
|-------|-------------|-------|-------------|
| 1 | VCC | 2 | GND |
| 3 | TCK | 4 | TDO |
| 5 | TDI | 6 | TMS |

J6: RESET

| Pin # | Signal Name | Pin # | Signal Name |
|-------|-------------|-------|-------------|
| 1 | RST_SW | 2 | GND |

J7: Redundancy (Optional)

| Pin # | Signal Name | Pin # | Signal Name |
|-------|-------------|-------|--------------|
| 1 | GND | 2 | SYS-FAIL-OUT |
| 3 | SYS-FAIL-IN | 4 | GPCS0 |
| 5 | SYS-GPCS-IN | 6 | TXD9\ |
| 7 | RXD9\ | | |

J8: System-Fail-Switch (Optional)

| Pin # | Signal Name |
|-------|-------------|
| 1 | SYS-SW-IN |
| 2 | GND |

J9: PS/2 Keyboard

| Pin # | Signal Name | Pin # | Signal Name |
|-------|-------------|-------|-------------|
| 1 | KBCLK | 2 | KBDAT |
| 3 | NC | 4 | GND |
| 5 | VCC | | |

J10: PS/2 Mouse

| Pin # | Signal Name | Pin # | Signal Name |
|-------|-------------|-------|-------------|
| 1 | MSCLK | 2 | MSDATA |
| 3 | NC | 4 | GND |
| 5 | VCC | | |

J11: COM1 (Optional: TTL / GPIO-P4 / PWMx8)

| Pin # | Signal Name | Pin # | Signal Name |
|-------|-------------|-------|-------------|
| 1 | DCD1 | 2 | RXD1 |
| 3 | TXD1 | 4 | DTR1 |
| 5 | GND | 6 | DSR1 |
| 7 | RTS1 | 8 | CTS1 |
| 9 | RI1 | 10 | NC |

J12: COM2 RS232 / 422 / 485 (Optional: TTL / PWM [8254 counter])

| Pin # | Signal Name | Pin # | Signal Name |
|-------|-------------------------------|-------|------------------------------|
| 1 | DCD2 / 422TX- / RS485- | 2 | RXD2 / 422TX+ / S485+ |
| 3 | TXD2 / 422RX+ | 4 | DTR2 / 422RX- |
| 5 | GND | 6 | DSR2 |
| 7 | RTS2 | 8 | CTS2 |
| 9 | RI2 | 10 | NC |

J13: GPIO (Port 0/1 / PWMx16)

| Pin # | Signal Name | Pin # | Signal Name |
|-------|-------------|-------|-------------|
| 1 | GND | 2 | VCC |
| 3 | GP00 | 4 | GP10 |
| 5 | GP01 | 6 | GP11 |
| 7 | GP02 | 8 | GP12 |
| 9 | GP03 | 10 | GP13 |
| 11 | GP04 | 12 | GP14 |
| 13 | GP05 | 14 | GP15 |
| 15 | GP06 | 16 | GP16 |
| 17 | GP07 | 18 | GP17 |
| 19 | VCC | 20 | GND |

J15: RS485 (Auto direction)

| Pin # | Signal Name |
|-------|-------------|
| 1 | RS485+ |
| 2 | RS485- |
| 3 | GND |

J16: Power Connector (Terminal Block 5.0mm)

| Pin # | Signal Name |
|-------|-------------|
| 1 | +5V |
| 2 | GND |

J17: COM3 (Optional: TTL)

| Pin # | Signal Name | Pin # | Signal Name |
|-------|-------------|-------|-------------|
| 1 | DCD3 | 2 | RXD3 |
| 3 | TXD3 | 4 | DTR3 |
| 5 | GND | 6 | DSR3 |
| 7 | RTS3 | 8 | CTS3 |
| 9 | RI3 | 10 | NC |

J18: PRINT

| Pin # | Signal Name | Pin # | Signal Name |
|-------|-------------|-------|-------------|
| 1 | STB- | 14 | AFD- |
| 2 | PD0 | 15 | ERR- |
| 3 | PD1 | 16 | INIT- |
| 4 | PD2 | 17 | SLIN- |
| 5 | PD3 | 18 | GND |
| 6 | PD4 | 19 | GND |
| 7 | PD5 | 20 | GND |
| 8 | PD6 | 21 | GND |
| 9 | PD7 | 22 | GND |
| 10 | ACK- | 23 | GND |
| 11 | BUSY | 24 | GND |
| 12 | PE | 25 | GND |
| 13 | SLCT | 26 | NC |

J19: COM4 (Optional: TTL)

| Pin # | Signal Name | Pin # | Signal Name |
|-------|-------------|-------|-------------|
| 1 | DCD4 | 2 | RXD4 |
| 3 | TXD4 | 4 | DTR4 |
| 5 | GND | 6 | DSR4 |
| 7 | RTS4 | 8 | CTS4 |
| 9 | RI4 | 10 | NC |

J20: PC104 Connector – 64pin

| Pin # | Signal Name | Pin # | Signal Name |
|-------|-------------|-------|-------------|
| 1 | IOCHCHK* | 2 | GND |
| 3 | SD7 | 4 | RESETDRV |
| 5 | SD6 | 6 | VCC |
| 7 | SD5 | 8 | IRQ9 |
| 9 | SD4 | 10 | -5V |
| 11 | SD3 | 12 | DRQ2 |
| 13 | SD2 | 14 | -12V |
| 15 | SD1 | 16 | OWS |
| 17 | SD0 | 18 | +12V |
| 19 | IOCHRDY | 20 | GND |
| 21 | AEN | 22 | SMEMW* |
| 23 | SA19 | 24 | SMEMR* |
| 25 | SA18 | 26 | IOW* |
| 27 | SA17 | 28 | IOR* |
| 29 | SA16 | 30 | DACK3* |
| 31 | SA15 | 32 | DRQ3 |
| 33 | SA14 | 34 | DACK1* |
| 35 | SA13 | 36 | DRQ1 |
| 37 | SA12 | 38 | REFRESH* |
| 39 | SA11 | 40 | SYSCLK |
| 41 | SA10 | 42 | IRQ7 |
| 43 | SA9 | 44 | IRQ6 |
| 45 | SA8 | 46 | IRQ5 |
| 47 | SA7 | 48 | IRQ4 |
| 49 | SA6 | 50 | IRQ3 |
| 51 | SA5 | 52 | DACK2* |
| 53 | SA4 | 54 | TC |
| 55 | SA3 | 56 | BALE |
| 57 | SA2 | 58 | VCC |
| 59 | SA1 | 60 | OSC |
| 61 | SA0 | 62 | GND |
| 63 | GND | 64 | GND |

J21: PC104 Connector – 40pin

| Pin # | Signal Name | Pin # | Signal Name |
|-------|-------------|-------|-------------|
| 1 | GND | 2 | GND |
| 3 | MEMCS16* | 4 | SBHE* |
| 5 | IOCS16* | 6 | SA23 |
| 7 | IRQ10 | 8 | SA22 |
| 9 | IRQ11 | 10 | SA21 |
| 11 | IRQ12 | 12 | SA20 |
| 13 | IRQ15 | 14 | SA19 |
| 15 | IRQ14 | 16 | SA18 |
| 17 | DACK0* | 18 | SA17 |
| 19 | DRQ0 | 20 | MEMR* |
| 21 | DACK5* | 22 | MEMW* |
| 23 | DRQ5 | 24 | SD8 |
| 25 | DACK6* | 26 | SD9 |
| 27 | DRQ6 | 28 | SD10 |
| 29 | DACK7* | 30 | SD11 |
| 31 | DRQ7 | 32 | SD12 |
| 33 | VCC | 34 | SD13 |
| 35 | MASTER* | 36 | SD14 |
| 37 | GND | 38 | SD15 |
| 39 | GND | 40 | NC |

J22: 4P Power Source (Interconnect to PC/104 – J20)

| Pin # | Signal Name |
|-------|-------------|
| 1 | -5V |
| 2 | -12V |
| 3 | +12V |
| 4 | GND |

J23: PC/104 + (Optional)

VI/O Default setting: +5V

If you need to use VI/O as +3.3V, please see the page 19.

| Pin # | A | B | C | D |
|-------|-----------|-----------|-----------|-----------|
| 1 | GND | NC | +5V | AD00 |
| 2 | VI/O(+5V) | AD02 | AD01 | +5V |
| 3 | AD05 | GND | AD04 | AD03 |
| 4 | C/BE0# | AD07 | GND | AD06 |
| 5 | GND | AD09 | AD08 | GND |
| 6 | AD11 | VI/O(+5V) | AD10 | GND |
| 7 | AD14 | AD13 | GND | AD12 |
| 8 | +3.3V | C/BE1# | AD15 | +3.3V |
| 9 | SERR# | GND | NC | PAR |
| 10 | GND | PERR# | +3.3V | NC |
| 11 | STOP# | +3.3V | LOCK# | GND |
| 12 | +3.3V | TRDY# | GND | DEVSEL# |
| 13 | FRAME# | GND | IRDY# | +3.3V |
| 14 | GND | AD16 | +3.3V | C/BE2# |
| 15 | AD18 | +3.3V | AD17 | GND |
| 16 | AD21 | AD20 | GND | AD19 |
| 17 | +3.3V | AD23 | AD22 | +3.3V |
| 18 | IDSEL0 | GND | IDSEL1 | IDSEL2 |
| 19 | AD24 | C/BE3# | VI/O(+5V) | IDSEL3 |
| 20 | GND | AD26 | AD25 | GND |
| 21 | AD29 | +5V | AD28 | AD27 |
| 22 | +5V | AD30 | GND | AD31 |
| 23 | REQ0# | GND | REQ1# | VI/O(+5V) |
| 24 | GND | REQ2# | +5V | GNT0# |
| 25 | GNT1# | VI/O(+5V) | GNT2# | GND |
| 26 | +5V | CLK0 | GND | CLK1 |
| 27 | CLK2 | +5V | CLK3 | GND |
| 28 | GND | INTD# | +5V | RST# |
| 29 | +12V | INTA# | INTB# | INTC# |
| 30 | -12V | NC | NC | GND |

Please remove the 0 ohm (1206 type) of R212 and add 0 ohm (1206 type) on R213

PC-104 VIO Pin 從 5V 跳至 3.3V :
將 R212 拆下焊至 R213

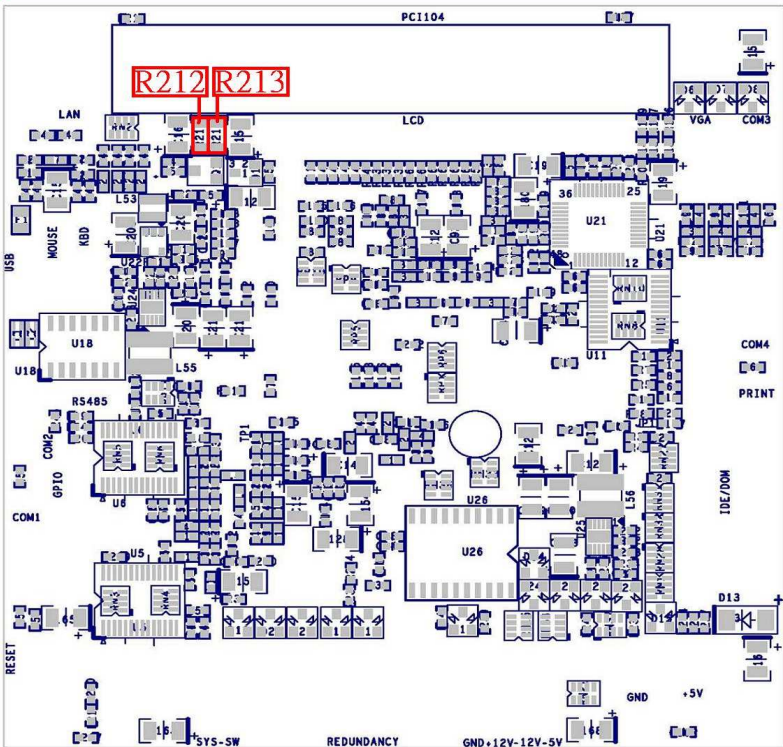

J24: VGA

| Pin # | Signal Name | Pin # | Signal Name |
|-------|-------------|-------|-------------|
| 1 | R OUT | 2 | GND |
| 3 | G OUT | 4 | GND |
| 5 | B OUT | 6 | GND |
| 7 | HSYNC | 8 | GND |
| 9 | VSYNCD | 10 | GND |

J25: LCD (DVO) Connector

| Pin # | Signal Name | Pin # | Signal Name |
|-------|-------------|-------|-------------|
| 1 | +3.3V | 2 | +3.3V |
| 3 | LG2 | 4 | LG3 |
| 5 | LG4 | 6 | LG5 |
| 7 | NC | 8 | NC |
| 9 | LR0 | 10 | LR1 |
| 11 | LR2 | 12 | LR3 |
| 13 | LR4 | 14 | LR5 |
| 15 | GND | 16 | NC |
| 17 | NC | 18 | NC |
| 19 | NC | 20 | GND |
| 21 | NC | 22 | NC |
| 23 | LB0 | 24 | LB1 |
| 25 | LB2 | 26 | LB3 |
| 27 | LB4 | 28 | LB5 |
| 29 | NC | 30 | NC |
| 31 | LG0 | 32 | LG1 |
| 33 | GND | 34 | GND |
| 35 | NC | 36 | LCLK |
| 37 | NC | 38 | LDE |
| 39 | NC | 40 | LHSYNC |
| 41 | NC | 42 | LVSYSN |
| 43 | LBACKL | 44 | LVDDEN |

[\(Please refer to Appendix A, for TFT Flat Panel Data Output\)](#)

J33: LINE OUT

| Pin # | Signal Name |
|-------|-------------|
| 1 | LOUTR |
| 2 | GND |
| 3 | GND |
| 4 | LOUTL |

J34: MIC-IN

| Pin # | Signal Name |
|-------|-------------|
| 1 | MICVREF |
| 2 | GND |
| 3 | GND |
| 4 | MIC-IN |

2.5 System Mapping

System Mapping

Memory Mapping

| Address | Description | Usage |
|---------------------|--|-------|
| 0000:0000-9000:FFFF | System RAM | * |
| A000:0000-A000:FFFF | EGA/VGA Video Memory | * |
| B000:0000-B000:7FFF | MDA RAM, Hercules graphics display RAM | * |
| B000:8000-B000:FFFF | CGA display RAM | * |
| C000:0000-C000:7FFF | EGA/VGA BIOS ROM | * |
| C000:8000-C000:FFFF | Boot ROM enable. | * |
| D000:0000-D700:FFFF | Expansion ROM space. | |
| D800:0000-DB00:FFFF | SPI FLASH Emulation Floppy A Enable | |
| DC00:0000-DF00:FFFF | Expansion ROM space. | |
| E000:0000-E000:FFFF | USB Legacy SCSI ROM space. | * |
| F000:0000-F000:FFFF | Motherboard BIOS | * |

I/O Mapping

| I/O Address | Owner | Usage |
|---------------|----------------------------------|-------|
| 0000h - 000Fh | DMA 8237-1 | * |
| 0010h - 0017h | COM 9 | * |
| 0018h - 001Fh | Empty | |
| 0020h - 0021h | PIC 8259-1 | * |
| 0022h - 0023h | 6117D configuration port | * |
| 0024h - 002Dh | Empty | |
| 002Eh - 002Fh | Forward to LPC BUS | * |
| 0030h - 003Fh | Empty | |
| 0040h - 0043h | Timer counter 8254 | * |
| 0044h - 0047h | Empty | |
| 0048h - 004Bh | PWM counter 8254 | * |
| 004Ch - 004Dh | Empty | |
| 004Eh - 004Fh | Forward to LPC BUS | * |
| 0050h - 005Fh | Empty | |
| 0060h | Keyboard data port | * |
| 0061h | Port B + NMI control port | * |
| 0062h - 0063h | 8051 download 4K address counter | * |

| | | |
|---------------|--|---|
| 0064h | Keyboard status port | * |
| 0065h | WatchDog0 reload counter | * |
| 0066h | 8051 download 8bit data port | * |
| 0067h | WatchDog1 reload counter | * |
| 0068h - 006Dh | WatchDog1 control register | * |
| 006Eh - 006Fh | Empty | |
| 0070h - 0071h | CMOS RAM port | * |
| 0072h - 0075h | MTBF counter | * |
| 0076h - 0077h | Empty | |
| 0078h - 007Ch | GPIO port 0,1,2,3,4 default setup | * |
| 007Dh - 007Fh | Empty | |
| 0080h - 008Fh | DMA page register | * |
| 0090h - 0091h | Empty | |
| 0092h | System control register | * |
| 0093h - 0097h | Empty | |
| 0098h - 009Ch | GPIO direction control | * |
| 00A0h - 00A1h | PIC 8259-2 | * |
| 00A2h - 00BFh | Empty | |
| 00C0h - 00DFh | DMA 8237-2 | * |
| 00E0h - 00FFh | Empty | |
| 0100h - 0101h | GPCS1 default setting address | * |
| 0170h - 0177h | IDE1 (IRQ 15) | |
| 01F0h - 01F7h | IDE0 (IRQ 14) | * |
| 0220h - 0227h | COM8 Forward to LPC BUS | |
| 0228h - 022Fh | COM7 Forward to LPC BUS | |
| 0238h - 023Fh | COM6 Forward to LPC BUS | |
| 0278h - 027Fh | Printer port (IRQ 7, DMA 0) | * |
| 02E8h - 02EFh | COM4 (IRQ 11) | * |
| 02F8h - 02FFh | COM2 (IRQ 3) | * |
| 0338h - 033Fh | COM5 Forward to LPC BUS | |
| 0376h | IDE1 ATAPI device control write only register | * |
| 03E8h - 03EFh | COM3 (IRQ 10) | * |
| 03F0h - 03F7h | Floppy Disk (IRQ 6, DMA 2) | |
| 03F6h | IDE0 ATAPI device control write only register | * |
| 03F8h - 03FFh | COM1 (IRQ 4) | * |
| 0480h - 048Fh | DMA High page register | * |
| 0490h - 0499h | Instruction counter register | * |
| 04D0h - 04D1h | 8259 Edge,/ level control register | * |
| 0CF8h - 0CFFh | PCI configuration port | * |
| D400h - D4FFh | on board LAN | * |
| FC00h - FC05h | SPI Flash BIOS control register | * |
| FC08h - FC0Dh | External SPI BUS control register (output pin configurable GPIO3[0-3]) | * |

| IRQ Mapping | | |
|--------------------|------------------------|--------------|
| IRQ# | Description | Usage |
| IRQ0 | System Timer | * |
| IRQ1 | Keyboard Controller | * |
| IRQ2 | Cascade for IRQ8 - 15 | |
| IRQ3 | Serial Port 2 | * |
| IRQ4 | Serial Port 1 | * |
| IRQ5 | USB | * |
| IRQ6 | Ethernet 10/100M LAN | * |
| IRQ7 | Parallel Port | * |
| IRQ8 | Real Time Clock | * |
| IRQ9 | Serial Port 9 | * |
| IRQ10 | Serial Port 3 | * |
| IRQ11 | Serial Port 4 | * |
| IRQ12 | Mouse | * |
| IRQ13 | Math Coprocessor | * |
| IRQ14 | Hard Disk Controller#1 | * |
| IRQ15 | USB | * |

| DMA Mapping | | |
|--------------------|------------------------|--------------|
| DMA# | Description | Usage |
| DMA0 | | |
| DMA1 | | |
| DMA2 | Floppy Disk Controller | |
| DMA3 | | |
| DMA5 | | |
| DMA6 | | |
| DMA7 | | |

2.6 Watchdog Timer

There are two watchdog timers in Vortex86SX/DX CPU. One is compatible with M6117D watchdog timer and the other is new. The M6117D compatible watchdog timer is called WDT0 and new one is called WDT1.

We also provide DOS, Linux and WinCE example for your reference. For more technical support, please visit: <http://www.dmp.com.tw/tech> or download the PDF file:

<http://www.dmp.com.tw/tech/vortex86dx/>

2.7 GPIO (General Purpose Input / Output)

40 GPIO pins are provided by the Vortex86SX/DX for general usage in the system. All GPIO pins are independent and can be configured as inputs or outputs, with or without pull-up/pull-down resistors.

We also offer DOS, Linux and WinCE example for your reference. For more technical support, please visit: <http://www.dmp.com.tw/tech> or download the PDF file:

<http://www.dmp.com.tw/tech/vortex86dx/>

2.8 SPI flash (Serial Peripheral Interface)

As SPI Flash (Serial Peripheral Interface) offers many benefits including: reduced controller pin count, smaller and simpler PCBs, reduced switching noise, less power consumption, and lower system cost

Many of users may consider using a formatted SPI flash to boot for the system or emulate SPI flash as Floppy (A: Driver or B: Driver). Then you must know how to set for this condition in CMOS Setup and boot up under DOS 6.22, X-DOS, DR-DOS and Free DOS.

For more technical support, please visit: <http://www.dmp.com.tw/tech> or download the PDF file: <http://www.dmp.com.tw/tech/vortex86dx/>

2.9 PWM (Pulse-width modulation)

Pulse-width modulation (PWM) of a signal or power source involves the modulation of its duty cycle, to either convey information over a communications channel or control the amount of power sent to a load.

The popular applications of pulse width modulation are in speed control of electric motors, volume control of Class D audio amplifiers or brightness control of light sources and many other power electronics applications.

The Vortex86DX SoC integrated 32 channels of PWM interface enabling the Automation, robotic industry to a New Age x86 SoC platform and we also offer the sample code of PWM which will guide the engineer to control the PWM functionality smoothly.

For more inquire of this sample code that please contact our sales team or mail to:

info@icop.com.tw

3.0 IDE to SD (Micro-SD)

Vortex86DX SoC also built-in simulation circuit to adapt SD to IDE in order to allow your system to recognize Micro-SD card as C: or D: Driver

SD-1917: 44 pins IDE to SD Adapter is an ideal solution for industrial PC or embedded system and 44 pins IDE to SD Adapter can be easily installed on all Vortex86DX-63xx CPU boards. You or your customers just do the BIOS setting and use SD-1917 to connect IDE connector of Vortex86DX-63xx directly.

For further inquiries of SD-1917, please contact ICOP sales team or mail to: info@icop.com.tw for your request.

<BIOS setting>

- Get into the BIOS setup Utility
- Choose Primary IDE Pin Select: SD card
- Press “F10” to Save configuration changes and exit setup

SD-1917

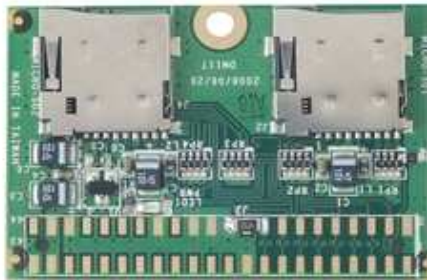

SD-1917: <http://www.icop.com.tw/pddetail.aspx?id=125&pid=4>

Chapter 3

Driver Installation

VGA

The Vortex86DX processor also use external Display chip “Volari™ Z9s” which is an ultra low powered graphics chipset with total power consumption at around 1-1.5 W. It is capable in providing VGA display output upto 1600x1200. With DVO interface, developers could easily connect flat Panel to support TFT and LVDS output.

LAN

The Vortex86DX processor also integrated 10/100Mbps Ethernet controller that supports both 10/100BASE-T and allows direct connection to your 10/100Mbps Ethernet based Local Area Network for full interaction with local servers, wide area networks such as the Internet.

The controller supports: Half / Full-Duplex Ethernet function to double channel bandwidth, auto media detection.

AUDIO

CM119 is a highly integrated single chip USB audio controller specifically for VoIP (Voice over internet protocol) application. All essential analog modules are embedded in CM119, including dual DAC and earphone driver, ADC, microphone booster, PLL, regulator, and USB transceiver. 8 GPIO pins can constitute a 24 key matrix directly support keypad control function without MCU.

Many features are programmable with jumper pins or external EEPROM. Vender can customize unique USB VID/PID to EEPROM for VoIP software authentication. Moreover, individual unique phone number for each device is possible via serial number stored in external EEPROM.

Operating system support

The Vortex86DX-6354RD PC/104 CPU board supports Embedded software: Free DOS, DOS 6.22, PCDOS 7.1, DR-DOS, x-DOS, OS/2, Windows CE 6.0, Windows 98, Windows XP Professional, Windows Embedded standard (XPE) and Windows 2000 (SP4).

Please get the drivers from the Driver CD which attached with the standard packing of Vortex86DX-6354RD board or please get it from DMP official website:

<http://www.dmp.com.tw/tech/vortex86dx/>

Vortex86DX-6354RD also supports most of the popular Linux distributions, for more detail information, please visit DMP official website: <http://www.dmp.com.tw/tech/vortex86dx/>

Appendix

A. TFT Flat Panel Data Output

| Vortex86 SX/DX Pin Name | TFT LCD 18 / 24 Bits | |
|----------------------------|-------------------------|-------|
| 1 | VCC3 (3.3V) | VDD |
| 2 | VCC3 (3.3V) | VDD |
| 3 | LG2 | G2 |
| 4 | LG3 | G3 |
| 5 | LG4 | G4 |
| 6 | LG5 | G5 |
| 7 | NC | / |
| 8 | NC | / |
| 9 | LR0 | R0 |
| 10 | LR1 | R1 |
| 11 | LR2 | R2 |
| 12 | LR3 | R3 |
| 13 | LR4 | R4 |
| 14 | LR5 | R5 |
| 15 | GND | VSS |
| 16 | NC | / |
| 17 | NC | / |
| 18 | NC | / |
| 19 | NC | / |
| 20 | GND | VSS |
| 21 | NC | / |
| 22 | NC | / |
| 23 | LB0 | B0 |
| 24 | LB1 | B1 |
| 25 | LB2 | B2 |
| 26 | LB3 | B3 |
| 27 | LB4 | B4 |
| 28 | LB5 | B5 |
| 29 | NC | / |
| 30 | NC | / |
| 31 | LG0 | G0 |
| 32 | LG1 | G1 |
| 33 | GND | VSS |
| 34 | GND | VSS |
| 35 | NC | / |
| 36 | LCLK | XCLK |
| 37 | NC | / |
| 38 | LDE | DEN |
| 39 | NC | / |
| 40 | LHSYNC | HSYNC |
| 41 | NC | / |
| 42 | LVSYNC | VSYNC |
| 43 | LBACKL | / |
| 44 | LVDDEN | VDDEN |

B. TFT Flat Panel Support List

| Size | Brand | Resolution | Model No. |
|------|------------|-----------------------|-----------------------|
| 5.7" | Data image | 320x240 | FG050701DSSWBG01 |
| 5.7" | Optrex | 320x240 | 55264GD057J-FW-ABN |
| 5.7" | TOSHIBA | 320x240 | LTA057A343F |
| 5.7" | Sharp | 320x240 (QVGA / VGA) | LQ057Q3DC02 |
| 5.7" | Kyocera | 320x240 (QVGA / VGA) | TCG057QV1AC-G10 |
| 5.7" | PVI | 320x240 (QVGA / VGA) | PD057VU4 /U5 |
| 5.7" | Data image | 640x480 | FG050710DSSWJG01/DG01 |
| 5.7" | Ampire | 640x480 | AM-640480GTMQW-T00H |
| 5.7" | URT | 640x480 | UMSH-8004MD-T |
| 5.7" | Sharp | 640x480 | LQ057V3DG01 |
| 5.7" | CPT | 640x480 | CLAA057VA01 |
| 6.4" | PVI | 640x480 | V16C6448AC |
| 6.4" | LG-PHILIPS | 640x480 | LB064V02 |
| 6.4" | PVI | 640x480 | PD064VT2 /VT4 /VT5 |
| 6.4" | Sharp | 640x480 | LQ064V3DG01 |
| 7" | AUO | 800x480 | C070VW02V0 |
| 7" | Data image | 800x480 | FG0700A0DSSWBG01 |
| 7" | LG-PHILIPS | 800x480 (TFT 24 bits) | LB070WV1 |
| 7" | HITACHI | 800x480 | TX18D57VM2BAA |
| 7" | Samsung | 800x480 | LMS700KF05 |
| 7" | PVI | 800x480 | PM070WL4 |
| 7" | URT | 800x480 | UMSH-8173MD-1T |
| 7" | CHI HSIN | 800x480 | LW700AT9309 |
| 8" | Sharp | 640x480 | LQ080V3DG01 |

C. LVDS Flat Panel Support List

If you would like to use LVDS Flat Panel with Vortex86SX / Vortex86DX series, please contact our regional sales to get ICOP-0096 information or visit ICOP website:

<http://www.icop.com.tw/pddetail.aspx?id=65&pid=4>

ICOP-0096: 18-bit TFT to LVDS converter and Cable-LVDS-30: LVDS Cable 30cm

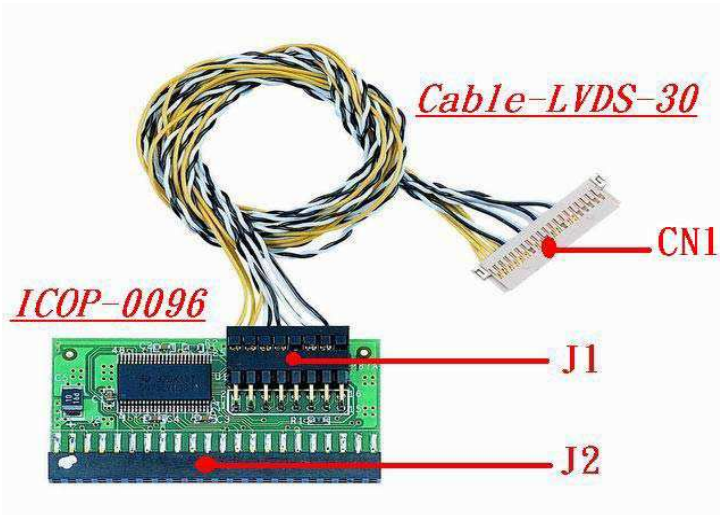

Approved LVDS Flat Panel List

| Size | Brand | Resolution | Model No. |
|-------|-------|------------|---------------|
| 3.5" | PVI | 640x480 | PD035VL1 |
| 5" | PVI | 640x480 | PD050VL1 |
| 6.5" | AUO | 640x480 | G065VN01 |
| 8.4" | AUO | 800x600 | G084SN03 |
| 8.9" | AUO | 1024x600 | A089SW01 |
| 8.9" | CPT | 1024x600 | CLAA089NA0ACW |
| 10.4" | AUO | 800x600 | G104SN02 |
| 12.1" | AUO | 800x600 | G121SN01 |
| 15" | AUO | 1024x768 | G150XG01 |

D. Flat Panel Wiring and Lighting

■ Hardware

Before you connect the TFT LCD Flat Panel with Vortex86DX-6354RD, please make sure that the input Voltage of LCD is + 3.3V or Not

■ BIOS

Please contact or e-mail our regional sales to get the special BIOS for the any TFT LCD Flat Panels.

■ Wiring LCD Cable

Please refer to [Page 20 \(J25: LCD connector\)](#) and [Page 31~35](#). Or for more LCD lighting and integration service, please contact our regional sales or mail to info@icop.com.tw ,if you have any questions.

E. TCP/IP library for DOS real mode

DSock is a TCP/IP library for DOS real mode, which is used by RSIP. It provides simple C functions for programmer to write Internet applications. ICOP also provide Internet examples using DSock: BOOTP/DHCP, FTP server, SMTP client/server, HTTP server, TELNET server, Talk client/server, etc.

DSock provides a lot of example source code. Programmer can add Internet functions to their project easily and save development time. With a utility "MakeROM", programmer also can make a ROM image to fit their application, those examples can be seen in the following Application systems: Mity-Mite Serial Server, Web Camera Tiny Server and RSIP Serial Server.

DSock is free for All ICOP products using M6117D/Vortex86/Vortex86SX/Vortex86DX CPU and ICOP also provide the business version of DSock for those customers who are using other x86 CPUs.

If you would like to use DSock or business version of DSock, Please mail to info@icop.com.tw or contact your regional sales.

Please download the trial DSock software and Utilities from our website:
<http://www.dmp.com.tw/tech/dmp-lib/dsock/>

F. BIOS Default setting

If the system cannot be booted after BIOS changes are made, Please follow below procedures in order to restore the CMOS as default setting.

- Press “End” Key, when the power on



- Press to enter the AMI BIOS setup
- Press “F9” to Load Optimized Defaults
- Press “F10” to Save configuration changes and exit setup

Warranty

This product is warranted to be in good working order for a period of one year from the date of purchase. Should this product fail to be in good working order at any time during this period, we will, at our option, replace or repair it at no additional charge except as set forth in the following terms. This warranty does not apply to products damaged by misuse, modifications, accident or disaster. Vendor assumes no liability for any damages, lost profits, lost savings or any other incidental or consequential damage resulting from the use, misuse of, originality to use this product. Vendor will not be liable for any claim made by any other related party. Return authorization must be obtained from the vendor before returned merchandise will be accepted. Authorization can be obtained by calling or faxing the vendor and requesting a Return Merchandise Authorization (RMA) number. Returned goods should always be accompanied by a clear problem description.